

Durham E-Theses

The bird communities of three disused quarries on the Magnesian limestone of Durham county

Underhill, Mark

How to cite:

Underhill, Mark (1992) *The bird communities of three disused quarries on the Magnesian limestone of Durham county*, Durham theses, Durham University. Available at Durham E-Theses Online:
<http://etheses.dur.ac.uk/5705/>

Use policy

The full-text may be used and/or reproduced, and given to third parties in any format or medium, without prior permission or charge, for personal research or study, educational, or not-for-profit purposes provided that:

- a full bibliographic reference is made to the original source
- a [link](#) is made to the metadata record in Durham E-Theses
- the full-text is not changed in any way

The full-text must not be sold in any format or medium without the formal permission of the copyright holders.

Please consult the [full Durham E-Theses policy](#) for further details.

**THE BIRD COMMUNITIES OF THREE DISUSED QUARRIES ON THE MAGNESIAN
LIMESTONE OF DURHAM COUNTY**

by

Mark Underhill

A dissertation submitted in partial fulfilment of the requirements for the degree of Master of Science in
Advanced Ecology.

Biological Sciences

The University of Durham

1992

The copyright of this thesis rests with the author.
No quotation from it should be published without
his prior written consent and information derived
from it should be acknowledged.



24 FEB 1993

ACKNOWLEDGEMENTS

I would like to thank Dr. P. Hulme and Dr. V. Standen for their continued academic support throughout this project. I would also like to thank Sam Goldsack, without whose help I could not have attended the M.Sc. Advanced Ecology Course, course for her support throughout the year.

Thanks also go to the other members and staff of the M.Sc. Advanced Ecology Course for their help, advice and support during the year.

LIST FIGURES

Fig. 1.	Simplified geographical map showing the extent of the Magnesian Limestone escarpment and the position of the three disused quarry sites.	6
Fig. 2.	Simplified vegetation map of the three sites to show the major habitat formations, physical features and boundaries.	7
Fig. 3.	Pie charts to illustrate the relative proportions of groups of birds at the three sites.	16
Fig. 4.	A plot of species rank against species abundance and species rank against the log of species abundance to demonstrate the approximate fit of the log-normal species abundance model.	21
Fig. 5.	The frequency of occurrence of the eight habitat categories at each site.	28
Fig. 6.	The frequency of occurrence of a bird territory in eight habitat categories in comparison to the availability of the category in the random habitat sample.	30
Fig. 7.	Dendrogram representing the major divisions of a TWINSpan classification of the sample units according to their bird species composition.	33
Fig. 8.	A plot of the six axes combinations of the species scores obtained from the DCA ordination used to identify the outlying and rare species.	36
Fig. 9.	A plot of the species and sample scores for axes 1 and 2 of the DCA ordination without the "outliers".	37
Fig. 10.	A graphical representation of the output from CANOCO, to illustrate the process of removing superfluous variables.	41
Fig. 11.	A plot of the species scores and the biplot scores from the final CCA ordination.	43
Fig. 12.	A plot of the sample scores and the biplot scores from the final CCA ordination.	46
Fig. 13.	A comparison of the frequency with which the habitat is used by birds for defending territories; foraging; and other uses, in relation to its' availability in a random sample.	49
Fig. 14.	The frequency of foraging records in 5 habitat categories.	54
Fig. 15.	A comparison of the relative frequency of use of the micro-habitat and the height in the habitat by five common birds of the sites.	56
Fig. 16.	A comparison of the relative frequency of use of different perches and positions within the micro-habitat by five common birds of the sites.	57
Fig. 17.	A comparison of the relative frequency of use of different substrates and foraging manoeuvres by five common birds of the sites.	58

LIST OF TABLES

Table 1.	The total area of the three sites and the area under each of the major habitat formations.	8
Table 2.	The bird species recorded at the three sites, the Latin binomial and the abbreviation used in this study.	9
Table 3.	The status of the bird species recorded at the three sites and the number of territories.	17
Table 4.	The density of the bird species breeding at the three sites and their percentage contribution to the community.	18
Table 5.	A comparison of the breeding bird community at the three sites using Spearman's Rank coefficient, the Shannon-Weaver diversity index and a "t" test.	22
Table 6.	A comparison of the density of the bird species breeding at the three sites using the Coefficient of Variation (C).	24
Table 7.	Percentage foliage in the five major habitat formations at the three sites and the percentage frequency distribution of the eight habitat types.	26
Table 8.	The mean percentage species composition of the canopy and of the ground cover at the three sites.	27
Table 9.	Definition of the final twenty-one habitat variables found to best represent the variation between sites.	31
Table 10.	The inter-set correlations between environmental variables and sample axes, and the biplot scores of the environmental variables from the DCA ordination of the three sites.	39
Table 11.	The number of behavioural observations of each bird species and the number of observations in each of the fifteen micro-habitat categories.	48
Table 12.	The number of foraging records and the plant species or category in which it was recorded. Also the frequency of occurrence of the eight habitat categories in a random habitat sample and the frequency of use of the habitat categories by foraging birds.	52

CONTENTS

ABSTRACT	1
1.0 INTRODUCTION	2
1.1 Study aims	3
2.0 STUDY AREA	4
3.0 METHODS	9
3.1 Mapping the distribution of the birds	8
3.1.2 Spatial patterns of bird distribution	10
3.2 Habitat characterisation	10
3.3 Behavioural observations	11
4.0 RESULTS	14
4.1 The overall bird community	14
4.1.1 The bird community at Pittington	14
4.1.2 The bird community at Sherburn	14
4.1.3 The bird community at Wingate	19
4.2 The correlates of Jackdaw abundance	19
4.3 Comparisons of the bird communities at each site	19
4.3.1 Spearman's rank correlation coefficient	20
4.3.2 Shannon-Weaver diversity index	20
4.3.3 Comparison of bird species diversity at each site	20
4.3.4 The between site variation in individual species' density	23
4.3.5 Patterns in variation across the sites	23
4.4 Habitat description and classification	25
4.4.1 A summary of the variation in habitat variables between the sites	25
4.4.2 The distribution of bird territories in relation to available habitat	29
4.4.3 Final choice of habitat variables	29
4.5 Multivariate data analysis	29
4.5.1 TWINSpan analysis	32
4.5.2 Ordination of data	34
4.5.3 Identification of outliers	34
4.5.4 Ordination of species	35
4.5.5 Ordination of samples	38
4.5.6 Percent variation explained	38
4.5.7 Relationships between ordination and environmental variables	40

4.5.8 Removal of correlated and superfluous environmental variables	42
4.5.9 Constrained ordination	42
4.5.10 Species ordination and biplot scores	42
4.5.11 Sample ordination and biplot scores	45
4.5.12 The statistical significance of the constrained ordination	45
4.6 Behavioural Results	47
4.6.1 A summary of the behavioural records.	42
4.6.2 Habitat use	47
4.6.3 Linnets, Paridae and Dunnocks	50
4.6.4 The use of the habitat by foraging birds	51
4.6.6 The use of the micro-habitat by foraging birds	51
4.6.7 The foraging activities of five individual bird species	53
4.6.8 Use of the habitat by individual bird species	52
4.6.9 Use of the micro-habitat by individual bird species	55
4.6.10 Position and perch in the micro-habitat	55
4.6.11 Individual species foraging summary	59
5.0 DISCUSSION	59
5.1 The bird community	60
5.2 Habitat features important to birds	60
5.3 A question of scale	60
5.4 What makes a "good" quarry?	61
5.4.1 A "good" quarry for birds	62
5.4.2 Grassland and scrub balance	62
5.5 A snapshot in time	63
5.6 Conclusion	63
6.0 REFERENCES	65
APPENDIX	I

ABSTRACT

In order to assess the ornithological importance of three disused quarries on the Magnesian Limestone escarpment in Durham county the distribution and abundance of the breeding birds were examined using the CBC technique. Thirty-nine bird species were recorded on the sites, of which twenty-seven species were considered to be holding territories.

The habitat was also sampled at 137 randomly located 0.02 ha sample units at each site. Variables recorded were those that were thought to be the most important in influencing the distribution and abundance of the birds on the sites.

In addition to the census, the behaviour of all birds recorded on the sites during the same period was quantified.

Correlations between the breeding bird communities at the three sites and the habitat variables were explored using numerical classification (two-way indicator species analysis), indirect gradient analysis (detrended correspondence analysis) and direct gradient analysis (canonical correspondence analysis).

Ordination of the combined data from the three quarries illustrated a gradient of bird species composition from open grassland to enclosed canopy scrub. When the ordination was constrained by the environmental variables two environmental gradients became apparent. Both were associated with the increasing cover relating to the successional sequence at the quarries. The first gradient was that of uninterrupted succession from bare quarry to enclosed canopy ash woodland. The second gradient was from a well developed field layer to low scrub, which was interpreted as a form of sub-climax.

The behavioural analysis indicated that although broad patterns in habitat selection could be determined from the coarse scale approach, the more subtle patterns in habitat utilisation were lost at this level of analysis.

The importance of specific aspects of the habitat were elucidated using chi-square analysis. This analysis further indicated the importance of the hawthorn scrub to breeding and foraging birds. The grassland was also found to be important for foraging birds.

The implications of these findings in view of the importance of the quarries as examples of limestone grassland is discussed. The potential benefits to the common farmland avifauna of sympathetic management of these sites is also discussed.

The preliminary results of this study indicate that the appropriate management of the successional process at these sites could benefit both the avifauna and flora.

1.0 INTRODUCTION

The restoration of flooded sand and gravel workings specifically for an amenity and wildlife after-use has become an accepted and successful form of management of disused workings. A measure of the success of these undertakings is that close to a third of the British breeding populations of Canada goose (*Branta canadensis*) and Tufted duck (*Aythya fuligula*) are to be found on restored gravel pits (Andrews & Kinsman, 1990).

The potential for such a widespread use for disused quarries has yet to be realised. Recent reviews of the wildlife value of disused quarries in County Durham (Dunn 1980), and of more wide-ranging cover (Davis 1979; Humphries 1980), have illustrated the existing interest in some specific cases. Some quarries in County Durham are now actively managed under the guidance of English Nature and the Durham Wildlife Trust; others have management plans in the consultation phase (T. Barret, pers. comm.). Yet by far the majority of disused quarries in the county are still in private ownership and under no active management regime (Durham County Council 1979).

The quarries have in the past been worked vigorously or sluggishly, according to the demand for the various grades of stone (Richardson Davis & Evans 1980). Since the last published report of the state of the Magnesian Limestone escarpment, (Dunn 1980) two quarries mentioned as having recently closed (Running Waters and Witch Hill) are now being actively quarried (pers. obs.). It is perhaps the comparative ease with which these quarries are abandoned and re-opened that sets them apart from flooded gravel pits and results in the apparent dereliction of the sites rather than reclamation for an alternative after-use.

Many of the disused limestone quarry sites have associated with them areas of magnesian limestone grassland, calcareous grasslands in which blue-moor grass (*Sesleria albicans*) is dominant or co-dominant. In Britain these grasslands occur in a marked zone across Northern England to Western Ireland and form a link between the limestone grasslands of the south and the Arctic-alpine grasslands of Europe, including those of Northern Scotland, (Shimwell 1968). These grasslands support a wealth of species which include, in addition to the rarer plants at the limits of their distribution, others that are more widespread but restricted to limestone soils, and yet others that are found only in old pastures (Doody 1980). Examples of species of a more northern distribution which are near their lowland limits in Britain are: dark-red helleborine (*Epipactis atrorubens*), melancholy thistle (*Cirsium heterophyllum*) and Butterwort (*Pinguicula vulgaris*). Some species with a more southern distribution near the northern limits of their range are columbine (*Aquilegia vulgaris*), yellow-wort (*Blackstonia perfoliata*) and burnt orchid (*Orchis ustulata*). Of the wide variety of plants which are typical of limestone areas throughout Britain, the rock-rose (*Helianthemum chaemaecistus*) is of particular interest in the area as it is the food plant of the Durham Argus butterfly (*Aricia artaxerxes salmacidis*), a form of the Northern Brown Argus which is found only in eastern Durham. Other typical plant species of limestone include: wild thyme (*Thymus drucei*), quaking grass (*Briza media*), salad burnet (*Sanguisorba minor*), fairy flax (*Linum catharticum*), and kidney vetch (*Anthyllis vulneraria*). The phytogeographical significance of this community was recognised by the Nature Conservation Review (Ratcliffe 1978) which identified two

sites within the county as nationally important; Thrislington Plantation and Cassop Vale. However, since this review took place, increasing pressure on these and other sites from agriculture, industry and scrub encroachment has led to a loss of some species from these communities, and a loss of some of the sites altogether.

More recently it was discovered that left unused the derelict quarries provide suitable substrate conditions, which combined with a heavy local seed intensity from the relict rim flora and the initial absence from competition, give extremely rapid movement of *Sesleria albicans* and some of its associates into disused quarries. This has led to a considerable rise in interest in the quarry sites as wildlife refugia (Richardson *et al.* 1980). However the interest is mainly in the flora and invertebrate fauna. This bias is justified when looking at the communities using the "criteria" established by the Nature Conservation Review (Ratcliffe 1978), but the focus it places on just a few sites may obscure the potential benefits that may accrue to other species due to the large number of similar but less notable sites within the county.

When viewed in the context of the "wider countryside", the benefits of these sites to the common avifauna of farmland and hedges may be considerable. Recent reviews of the Common Bird Census trends (Evans 1992; Mead 1992) have led to serious concern that agricultural intensification may have had on the populations of many common farmland species. Over the last twenty years the CBC has revealed that populations of Linnet, Grey partridge, Bullfinch, Reed bunting, Skylark, Yellowhammer and Song thrush are all in decline (Evans 1992; Mead 1992). Many of these species, although considered birds of open ground rely on the cover of hedges and scrub for song-posts and nest sites (O'Connor & Shrub 1986). The scrub that quickly develops on the sites of disused quarries can be seen as a natural form of the cover these species normally seek in farm hedges, and it is no surprise to find many of the common species of farmland breeding in the scrub of disused quarries.

In view of these concerns, and the size of the potential resource (there is reported to be over 500 abandoned limestone and chalk workings in England (Humphries 1980)) and 111 of these are in County Durham (Evans 1980); an assessment of the ornithological status and potential of these sites in order to plan for future use is desirable.

1.1 Study aims

This study aims to assess the bird community at three disused quarry sites in County Durham and draw comparisons between the communities at these sites, and also to compare them to those in similar habitats elsewhere in Britain. In this way it is hoped to build up a picture of the bird community of the quarries and the surrounding scrub, and the potential at other sites in the county.

The habitat preferences of the breeding community will be assessed using multivariate analysis in order to overcome the cross-correlation amongst variables and fully appreciate the multidimensional character of habitat selection (Johnson 1981). In addition, behavioural observations of all species recorded on the site were made to further evaluate the importance of specific habitat features on the sites to individual bird species.

The objective is to clarify those features of the quarries and their surrounding habitats that are most important to breeding and foraging birds and provide a framework on which to base future studies or management of these and similar sites.

2.0 STUDY AREA

Breeding and foraging birds were studied in three disused magnesian limestone quarries, Pittington (NZ332430), Sherburn (NZ327417) and Wingate (NZ371375), situated on the western escarpment of the East Durham plateau (Fig. 1).

The quarries were selected to represent the major vegetation formations found at similar quarry sites in County Durham, and also to be broadly comparable to each other in area and habitat components. The overall area of the sites are Pittington 10.91 ha, Sherburn 10.40 ha and Wingate 10.84 ha (Tab. 1).

Pittington, Sherburn and Wingate quarries lie in a line running approximately north to south and the distance between the two furthest apart is 6km from centre to centre (Fig. 1). They are of similar altitude, lying in the range 100-500m. All three sites show varying stages of the succession from bare quarry stone, through limestone grassland, hawthorn (*Crataegus monogyna*) and gorse (*Ulex europaeus*) scrub to a woodland climax dominated by ash (*Fraxinus excelsior*) (Fig. 2).

The sites are all bordered by arable farmland along the majority of their boundaries. To reduce edge effects, the plots were chosen to be as near as possible square and the boundaries were not drawn through ornithologically rich areas, such as hedgerows. This follows the recommendations of Marchant (1981).

The history of the quarries is not well documented and all three sites have been periodically closed and re-opened, according to the demand for limestone products (Dunn 1980). Sherburn and Wingate were both quarried in parts until relatively recently, closing finally in 1976 (T. Barrett pers. comm.), though parts of both sites which have been quarried in the past show extensive development of the final successional stage in the establishment of ash woodland (Fig. 2) and are assumed to have been inactive for most of this century. Pittington in contrast shows no sign of recent quarrying activities and was reported in 1976 (Spencer 1976) to have been abandoned for at least 100 years.

Pittington Hill and Sherburn Hill are both designated Sites of Special Scientific Interest as they represent two of the few surviving sites on the escarpment supporting a range of the semi-natural Magnesian Limestone vegetation (sect. 1). There is limited management at both sites under the guidance of English Nature, and this is designed primarily to protect the limestone grassland, which is under increasing pressure from quarrying and agricultural intensification at other sites (NCC 1985).

Wingate quarry is a designated Local Nature Reserve, and is actively managed to enhance the already existing ecological interest conveyed by the limestone flora and invertebrate fauna. Management consists primarily of the control of scrub encroachment, and the re-seeding of bare areas with propagules collected rotationally from floristically rich areas of the reserve.

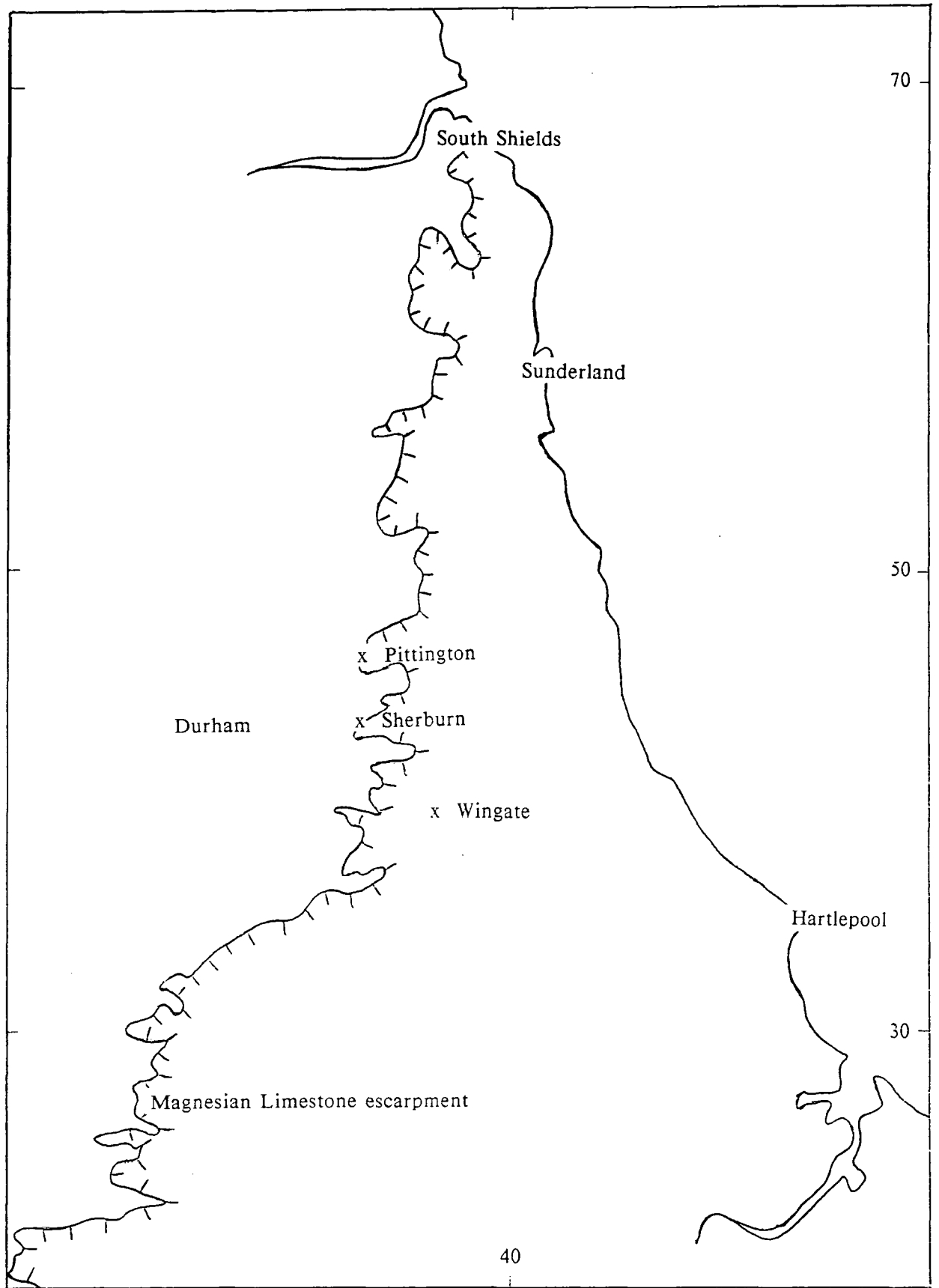







Figure 1. Simplified geographical map showing the extent of the Magnesian Limestone escarpment and the position of the three disused quarry sites; Pittington, Sherburn and Wingate.

KEY Site boundary 

Arable fields 

Grassland & scattered scrub 

Scrub patches 

Scrub & mature scrub 

Woodland 

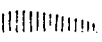
Slopes 

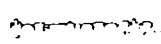
Quarry face 

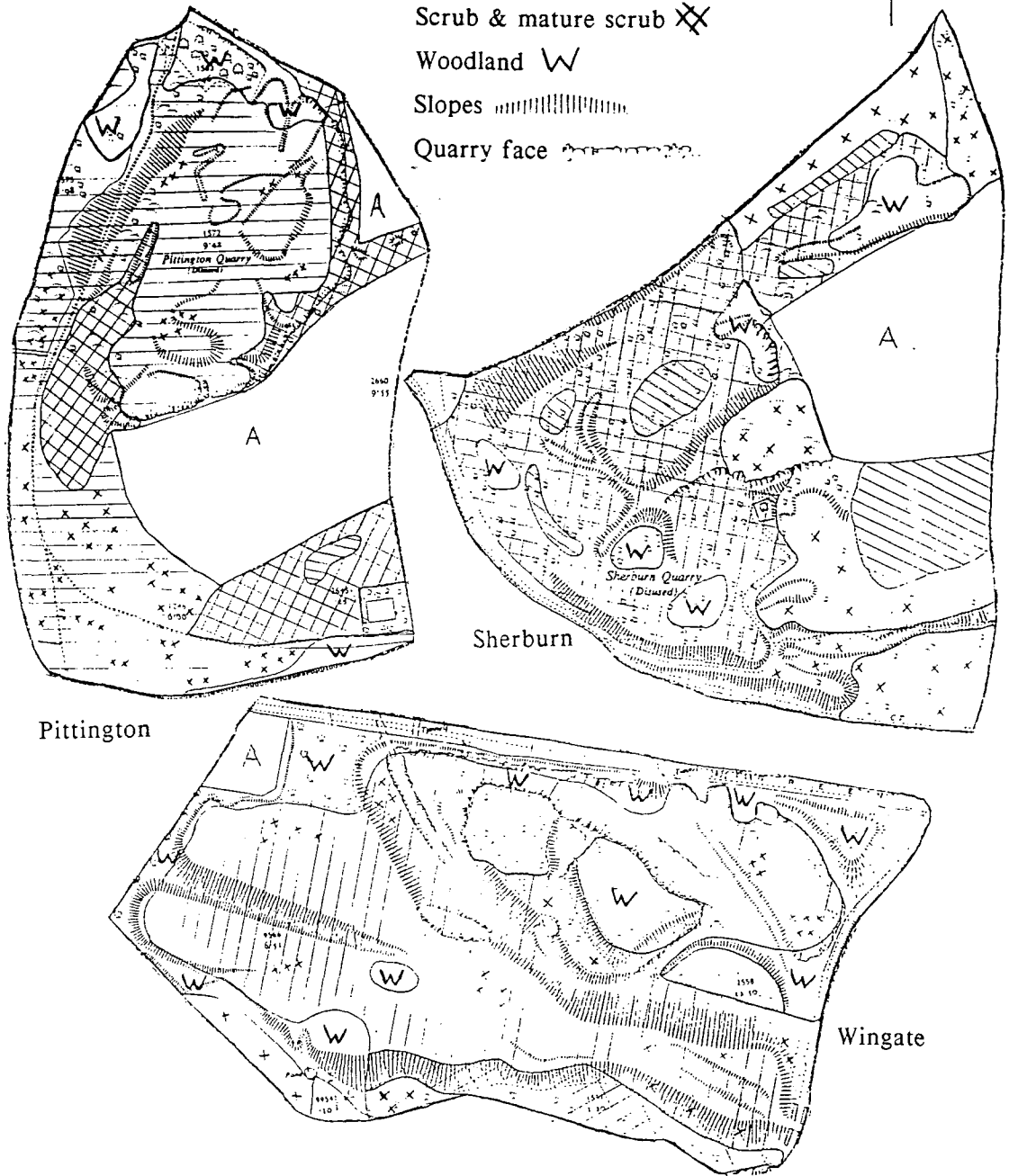
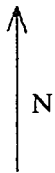

Figure 2. Simplified vegetation map of the three sites to show the major habitat formations, physical features and boundaries.

(a)

	Pittington	Sherburn	Wingate
Disused Quarry	4.00	7.89	10.54
Grassland/Scrub	3.83	0.49	0.00
Arable	3.08	2.02	0.30
Total	10.91	10.40	10.84

(b)

	Pittington	Sherburn	Wingate
Grassland	50	20	60
Scrub	25	55	5
Wood	5	5	10
Arable	25	20	5

Table 1. The study site areas in hectares and the major land-use categories (a). Categories within the quarry boundary are not listed separately. Also shown is the percentage cover of the four major groups of vegetation at the three sites estimated from the initial ground survey. Grassland includes all scattered scrub and scrub patches; Scrub includes mature scrub.

3.0 METHODS

3.1 Mapping the distribution of the birds

The distribution and abundance of birds within each quarry were determined using a territory mapping method following the guide-lines laid down by Common Bird Census scheme of the British Trust for Ornithology (Marchant 1983), and the International Bird Census Committee (1969). Ten visits were made to each quarry between mid April and mid July. The locations and activities of all species seen or heard were plotted on 1:1250 scale maps of the study areas. These plots are termed a "registration". The maps had been prepared from the Ordnance Survey 1:2500 scale maps and from aerial photographs. Details such as paths, clearings, groups of trees and conspicuous individual trees were added from an initial ground survey undertaken in early April. These additional details and the increased scale of the maps allowed the plotting of registrations with accuracy of approximately 10m, even in the inaccessible areas of dense scrub. The registrations were then transferred to species-specific maps and the resulting patterns interpreted in terms of territories. The interpretation was based mainly on patterns of spatial clustering and records of simultaneous singing males. This technique of delimiting territories can give only a general idea of the exact boundaries and is subject to a spectrum of different errors (Oelke 1981; Bibby, Burges & Hill 1992) but was considered to be the most effective for the requirements of the study and the density of the vegetation in the study sites.

Bird counts were made at each quarry at approximately weekly intervals between the 21st of April and the 9th of July. The total census consisted of 8 morning and 2 evening visits to each site. The morning visits started soon after first light to coincide with the peak in diurnal song activity of the majority of species that were being censused. The late evening visits were conducted mainly to detect the activity of Song thrushes and Blackbirds, which sing particularly strongly at dusk (Tomialojc & Lontkowski 1989). No additional effort was made to record crepuscular species. The April and early May visits were timed to coincide with a period when most resident species were singing strongly. By mid-May most of the resident species were silent and extremely difficult to detect in the dense scrub. The later visits were essential to record the summer visitors, especially the *Sylvia* warblers. On each visit the quarries were covered evenly and thoroughly, the routes being devised to pass within 50m of every part of the plot. Census routes were varied at each visit to ensure that bias due to diurnal variation in song output was minimised.

The territory mapping method is most effective in the censusing of "songbirds", usually defined as all passerines excluding Corvidae and starlings (Fuller and Henderson 1992), as they generally hold relatively small territories and range over limited areas. For more wide ranging species such as the Woodpigeon, Carrion crow, and Jackdaw, the location of nests and the counting of birds at roost were used to supplement the census visits.

In addition to the above methods territorial maps were supplemented by casual sightings during foraging observations. These sightings were also plotted on the same scale maps and included in the cluster analysis.

3.1.2 Spatial patterns of bird distribution

To examine spatial patterns of bird distribution within each quarry, each species specific map had a 30m grid superimposed upon it. The positioning and orientation of this grid was chosen at random. The intersections of the grid were then used to define the centre of a 0.02 ha sample unit. These sample units were used to collect details of both the habitat variables (see below), and the presence or absence of a species' territory. If the sample circle fell completely inside a species' territory (as defined by the territory maps) it was scored as present, if it fell outside or on the boundary it was scored as absent from that sample. Using this technique a matrix, of the 411 samples units and the presence or absence of the 27 species, was constructed. Relationships between the sample units were then examined using two multivariate techniques described by Gauch (1982). First, two-way indicator species analysis (TWINSPAN) was used to arrange the sample units into several groups, each containing sample units that were broadly similar in terms of their bird assemblages. Second detrended correspondence analysis, detrended by polynomials (CANOCO) was used to arrange the sample units and the bird species within a two-dimensional ordination space.

3.2 Habitat characterisation

The vegetation at the three quarries was sampled according to the methodology of Noon (1981). All three site maps had a 30m grid superimposed on them. The positioning and orientation of this grid was chosen at random. For each of the three sites, the grid and the sample circles were the same as those used in sampling the bird territories. The intersections of the grid were used to define the centre of a vegetation sample unit. Samples overlapping the edges of the plot were repositioned slightly, so they were completely within the site boundaries. This was necessary in less than 3% of the samples on each plot and was not considered to effect the random nature of the sampling. This sampling scheme allows direct comparison between species' structural habitats, comparison of each species against a random sample of the available habitat, and comparison between sites of the habitats available (Noon 1981).

The sample units were circles with a radius of 8m equivalent to an area 201m^2 or approximately 0.02ha. A 0.02ha sample was considered to be large enough to include an adequate sample of vegetation, whilst being small enough to avoid falling across too many ecotones and thereby averaging habitat characteristics that may be being discerned separately by some bird species.

The centre of each sample was located using the same 1:1250 site maps used to plot the bird census registrations and a Silva compass. The limits of the sample circle were defined using a modification of the range-finder method (James & Shugart 1970). A brightly coloured meter rule was positioned at the centre of the sample circle. This was sighted by holding at arms length a 30cm rule having a mark equal to the length of the first when viewed from 8m. With practice, confirmed using a

tape measure, this proved to be an accurate and efficient method of determining the limits of the sample circle.

A total of 137 0.02 ha sample circles were measured at each site. Within each circle 45 habitat variables were measured and entered on a standard form. The variables measured were those thought most likely to be important in influencing the distribution and abundance of bird species, and included features both of the habitat structure and species composition.

Definition of the 45 variables is given below. All percentage covers and foliage volumes were estimated in the field to the nearest 5%.

- a) **Canopy height:** The maximum height of the tree or shrub canopy estimated to the nearest 0.5m.
- b) **Canopy cover:** The percentage of the ground directly shaded by the canopy. The canopy was taken to include all trees and shrubs, including gorse, but excluding brambles (*Rubus* & *Rosa* spp.), and other woody perennial species.
- c) **Tree species cover:** The percentage of the ground directly shaded by canopy trees, was recorded in seven categories, six for named tree species and one for "other" tree species.
- d) **Shrub cover:** The percentage foliage volume in four structural height classes, shrubs 5-10m, 1.5-5m, 0-1.5m, herbs>30cm, field 0-30cm, and the percentage of the ground bare or covered by leaf litter.
- e) **Ground cover:** The percentage of ground covered by seven common shrubs or herbs, and also the percentage of the ground covered by leaf litter, bare quarry stone or some "other" ground cover.
- f) **Dense shrub layer:** The percentage cover of shrubs which formed a dense tangle, through which human passage was extremely difficult.
- g) **Hollow cover:** The percentage cover of shrubs, beneath and outside the canopy, with a poorly developed field layer. Typically with little or no foliage below 1m.
- i) **Habitat density:** This was placed into three categories by eye in the field according to the following criteria. "Open" habitats were those that it was possible to walk through with little difficulty. "Medium" habitats were those that it was possible to walk only either by stooping, crawling or by taking many deviations from a straight route. "Dense" habitats were those where human passage was at least extremely difficult.
- i) **Ground flora:** The structural complexity of the ground flora was also placed into three categories in the field according to the following criteria. Open floras were those that offered little resistance to human passage due to entanglement. Medium floras required some effort to walk through or contained small areas of dense flora. Dense floras were those where passage was made difficult by dense areas of species such as *Urtica dioica*, *Rosa* and *Rubus* spp.
- j) **Ecotones:** The number of major changes in vegetation type in each circle, and also the distance to the nearest ecotone from the centre of the circle.
- k) **Footpaths:** The number of footpaths within each circle and the distance to the nearest footpath was recorded as a measure of human use of the sites.

- l) **Habitat definition:** The habitat was placed in one of eight broad habitat categories which crudely corresponded to a succession from open grassland to woodland. Grass.-> scattered scrub -> scrub patches -> scrub -> mature scrub -> woodland. Hedges and arable fields were also placed in separate categories.

3.3 Behavioural observations

The behaviour of all bird species seen on the sites was quantified during the period from mid April to early July 1992. For the majority of species on the site this period encompassed the incubation, nestling, and fledgling periods of at least one brood.

To obtain the behavioural observations, I moved about the study plot on a systematic basis, observing as many different birds as possible. Walking and stationary searches for birds were alternated approximately every 15 minutes, and uncommon species, females, and non singing males were consciously sought to avoid bias toward conspicuous individuals. Also, concealing habitats, such as dense scrub, long grass and the upper canopy, were diligently searched. I attempted to obtain an equal number of observations of each species during each quarter of the daylight period. This permitted an unbiased random sample of the range of behaviours undertaken by the species during the study period (Hejl Verner & Bell 1990; Recher & Gebski and Sabo 1980).

Point observations, rather than sequential recordings, were used to ensure statistical independence between samples. An observation was considered sequential if it was not separated from the previous observation by at least one minute. In practice very few such observations were recorded due to the difficulty in maintaining contact with an individual in the dense habitats. Where birds occurred in either single or mixed species flocks, data were recorded for as many individuals as possible without repeating observations on the same bird. Once a bird was sighted its behaviour was recorded after waiting approximately 5 seconds, this further avoided recording only conspicuous behaviours. Nevertheless Raphael & Maurer (1990) estimate that most foraging studies record fewer than 1% of the behaviours occurring during the period of study, and this will lead to skewed distribution of observations. In this study I have attempted to reduce this bias to a minimum.

Once a bird had been sighted and the 5s elapsed, the following parameters were recorded:

- a) **Quadrat:** The quadrat the observation was made in, which included details of the site and position within the site.
- b) **Time:** The time of day and the date.
- c) **Species:** The species of bird, its' sex where sexual dimorphism was apparent and whether it was a juvenile or adult bird.
- d) **Plant:** The micro-habitat in which it was first seen. There were 18 possibilities within this parameter, 15 were tree or plant species, in addition there was ground, air and cliff.
- e) **Position:** The position of the species within the micro-habitat, defined as being proximal (a vertical axis extending from the tree's base to the top and extending away from the trunk one third of the total distance from the axis to the peripheral foliage), distal (the outermost

periphery of the tree extending towards the inner axis a third of the total distance to that axis), or middle (the region between inner and outer portions) (Landres & MacMahon 1983).

- f) **Perch:** The perch site, estimated as ground, trunk (>15cm in diameter), branch (1.5-15cm), twig (<1.5cm), bud, leaf, flower, plant stem, air or cliff.
- g) **Height:** The vertical height of the perch site, recorded in five structural height classes similar to those used in the habitat definitions (sect. 3.2), shrubs 5-10m, 1.5-5m, 0-1.5m, herbs>30cm, field 0-30cm and Ground 0cm.
- h) **Behaviour:** The birds behaviour, categorised as calling (including alarm calls), singing, foraging, nesting and other activities.
- i) **Foraging manoeuvre:** The foraging manoeuvre, defined as, gleaning (taking food from a surface), probing (taking food from beneath a surface), pecking (manipulating the foraging substrate in some way, such as in the scratching in leaf litter of some *Turdus* spp.) and hover-glean (taking a food from a surface whilst in flight) (Remsen & Robinson 1990).
- j) **Substrate:** The foraging substrate, defined in the same categories as the perch sites.

In addition to the above records of bird behaviour, a suite of records relating to the immediate macro-habitat surrounding the bird were also recorded in order to gain some insight into the choice of site for the birds activities in relation to the available habitat. The following parameters were recorded.

- k) **Habitat.**
- l) **Canopy height.**
- m) **Habitat density.**
- n) **Ground flora.**
- o) **Ecotones.**

The above parameters all have equivalents in the habitat characterisation, and the definitions of the categories can be found in section 3.2.

During the study period 1821 behavioural observations were recorded, (Pittington n=578, Sherburn n=587 and Wingate n=656). Of these 934 were foraging records, (Pittington n=363, Sherburn n=261 and Wingate n=310).

4.0 RESULTS

4.1 The overall bird community

A total of thirty-nine species were recorded on the three sites from mid-April to mid-July (Tab. 2). Of the total recorded, twenty-seven species (69%) were considered to be holding territories on at least one of the sites, this included three non-passerines, Cuckoo, Collared dove and Woodpigeon; and three *Corvidae* Magpie, Jackdaw and Carrion crow (Fig. 3a). A total of 388 territories was estimated at the three sites. This is equivalent to an overall density of 12.1 territories per hectare, (9.74 territories per hectare excluding Jackdaws). This is comprised of 75% songbirds, 21% *Corvidae*, and 4% non-passerines (Fig. 3b).

4.1.1 The bird community at Pittington

During the census period at Pittington a total of thirty-five species were recorded. Of these twenty-two held territories; nine were regularly encountered on the site, usually foraging, but were not seen to display territorial behaviour; four were encountered on 2 or less occasions (Tab. 3).

A total of 141 territories was estimated, 77% of which were songbirds, 18% were Jackdaws, and 5% were other *Corvidae* and non-passerines (Fig. 3c). This is equivalent to an overall density of 12.92 territories per hectare, and a songbird density of 9.99 territories per hectare (Tab. 4).

The dominant species, excluding the Jackdaw which is considered separately below, was Willow Warbler, which contributed 13.8% of the mapped territories.

4.1.2 The bird community at Sherburn

During the census period at Sherburn a total of thirty species were recorded. Of these twenty-two held territories; seven were regularly encountered on the site and one was seen on only one occasion (Tab. 3).

A total of 95 territories was estimated, 95% of which were songbirds, 5% of which were *Corvidae* other than Jackdaws, and non-passerines (Fig. 3d). This is equivalent to an overall density of 9.13 territories per hectare, and a songbird density of 8.65 territories per hectare (Tab. 4).

The dominant species was Willow Warbler, which contributed 15.8% of the mapped territories.

Common Name	Latin Binomial	Abbreviation
Sparrowhawk	<i>Accipiter nisus</i>	SH
Grey partridge	<i>Perdix perdix</i>	P
Collared dove	<i>Streptopelia decaocto</i>	CD
Woodpigeon	<i>Columba palumbus</i>	WP
Cuckoo	<i>Cuculus canorus</i>	CK
Swift	<i>Apus apus</i>	SI
Skylark	<i>Alauda arvensis</i>	S
Swallow	<i>Hirundo rustica</i>	SL
House martin	<i>Delichon urbica</i>	HM
Wren	<i>Troglodytes troglodytes</i>	WR
Duncock	<i>Prunella modularis</i>	D
Robin	<i>Erithacus rubecula</i>	R
Wheatear	<i>Oenanthe oenanthe</i>	W
Blackbird	<i>Turdus merula</i>	B
Song thrush	<i>Turdus philomelos</i>	ST
Mistle thrush	<i>Turdus viscivorus</i>	M
Lesser whitethroat	<i>Sylvia curruca</i>	LW
Whitethroat	<i>Sylvia communis</i>	WH
Garden warbler	<i>Sylvia borin</i>	GW
Blackcap	<i>Sylvia atricapilla</i>	BC
Willow warbler	<i>Phylloscopus trochilus</i>	WW
Willow tit	<i>Parus montanus</i>	WT
Coal tit	<i>Parus ater</i>	CT
Blue tit	<i>Parus caeruleus</i>	BT
Great tit	<i>Parus major</i>	GT
Longtailed tit	<i>Aegithalos caedatus</i>	LT
Treecreeper	<i>Certhia familiaris</i>	TC
Magpie	<i>Pica pica</i>	MG
Jackdaw	<i>Corvus monedula</i>	JD
Carrion crow	<i>Corvus corone</i>	CC
Starling	<i>Sturnus vulgaris</i>	SG
House sparrow	<i>Passer domesticus</i>	HS
Chaffinch	<i>Fringilla coelebs</i>	CH
Greenfinch	<i>Chloris chloris</i>	GR
Goldfinch	<i>Carduelis carduelis</i>	GO
Siskin	<i>Carduelis spinus</i>	SK
Linnet	<i>Carduelis cannabina</i>	LI
Bullfinch	<i>Pyrrhula pyrrhula</i>	BF
Yellowhammer	<i>Emberiza citrinella</i>	YH

Table 2. The bird species recorded at the three sites, the latin binomial, and the abbreviation used in this study.

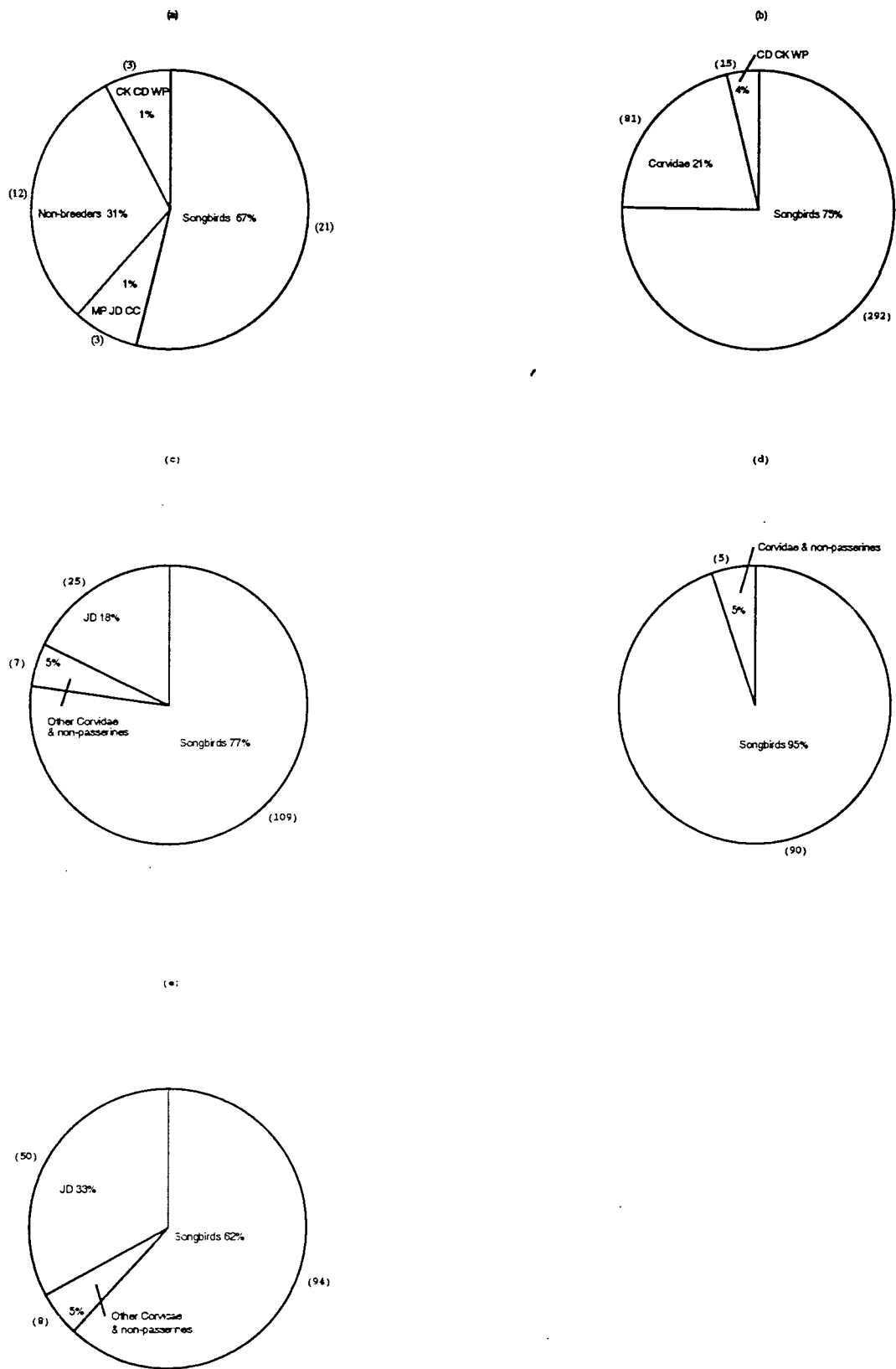

Figure 3. The relative numbers of songbirds, Corvidae and non-passerines at the sites. Number of species in each group recorded at all sites (a), (n = 39). Relative proportions of breeding species in each group at all sites (b), (n = 388). Relative proportions of breeding species at Pittington (c), (n = 141). Relative proportions of breeding species at Sherburn (d), (n = 95). Relative proportions of breeding species at Wingate (d) (n = 152). Species codes given in table 2.

Species	Status			Territories		
	P	S	W	P	S	W
Willow warbler	B	B	B	16	15	16
Linnet	B	B	R	12	8	0
Dunnock	B	B	B	11	7	4
Chaffinch	B	B	B	9	8	8
Whitethroat	B	B	B	8	9	8
Robin	B	B	B	8	7	10
Yellowhammer	B	B	B	7	6	7
Blackbird	B	B	B	7	4	6
Blue tit	B	B	B	7	2	7
Great tit	B	B	B	7	1	6
Wren	B	B	B	5	6	7
Songthrush	B	B	B	3	4	2
Lesser whitethroat	B	B	P	3	1	0
Collared dove	B	O	O	3	0	0
Woodpigeon	B	B	B	2	3	5
Blackcap	B	B	B	2	2	3
Bullfinch	B	B	B	2	2	2
Longtailed tit	B	B	B	1	3	4
Skylark	B	B	O	1	2	0
Magpie	B	B	B	1	1	3
Carrion crow	B	R	R	1	0	0
Garden warbler	P	B	P	0	2	0
Reedbunting	O	B	O	0	1	0
Cuckoo	R	B	P	0	1	0
Treecreeper	O	O	B	0	0	2
Goldfinch	R	O	B	0	0	1
Willow tit	P	P	B	0	0	1
Jackdaw	B	O	B	25	0	50
Siskin	O	P	O	0	0	0
Greenfinch	O	O	P	0	0	0
Coal tit	P	O	O	0	0	0
Wheatear	P	O	O	0	0	0
Mistlethrush	P	O	O	0	0	0
Housemartin	R	R	R	0	0	0
Swift	R	R	R	0	0	0
Starling	R	O	O	0	0	0
Swallow	R	R	R	0	0	0
Sparrowhawk	R	R	R	0	0	0
House sparrow	R	R	O	0	0	0
Total				141	95	152

Table3. Status of all species recorded at all three sites, Pittington (P), Sherburn (S), Wingate (W). First three columns show the status of the species; B = species recorded as defending a territory, R = species seen regularly on the site, P = species seen on the site on fewer than 4 occasions, O = species not recorded at that site. Second three columns show the number of territories estimated at each site.

Species	Territories			Breeding (%)		
	P	S	W	P	S	W
Willow warbler	1.47	1.44	1.48	13.79	15.79	15.69
Linnet	1.10	0.77	0.00	10.34	8.42	0.00
Duncock	1.01	0.67	0.37	9.48	7.37	3.92
Chaffinch	0.82	0.77	0.74	7.76	8.42	7.84
Whitethroat	0.73	0.87	0.74	6.90	9.47	7.84
Robin	0.73	0.67	0.92	6.90	7.37	9.80
Yellowhammer	0.64	0.58	0.65	6.03	6.32	6.86
Blackbird	0.64	0.38	0.55	6.03	4.21	5.88
Blue tit	0.64	0.19	0.65	6.03	2.11	6.86
Great tit	0.64	0.10	0.55	6.03	1.05	5.88
Wren	0.46	0.58	0.65	4.31	6.32	6.86
Songthrush	0.27	0.38	0.18	2.59	4.21	1.96
Lesser whitethroat	0.27	0.10	0.00	2.59	1.05	0.00
Collared dove	0.27	0.00	0.00	2.59	0.00	0.00
Woodpigeon	0.18	0.29	0.46	1.72	3.16	4.90
Blackcap	0.18	0.19	0.28	1.72	2.11	2.94
Bullfinch	0.18	0.19	0.18	1.72	2.11	1.96
Longtailed tit	0.09	0.29	0.37	0.86	3.16	3.92
Skylark	0.09	0.19	0.00	0.86	2.11	0.00
Magpie	0.09	0.10	0.28	0.86	1.05	2.94
Carrion crow	0.09	0.00	0.00	0.86	0.00	0.00
Garden warbler	0.00	0.19	0.00	0.00	2.11	0.00
Reed bunting	0.00	0.10	0.00	0.00	1.05	0.00
Cuckoo	0.00	0.10	0.00	0.00	1.05	0.00
Treecreeper	0.00	0.00	0.18	0.00	0.00	1.96
Goldfinch	0.00	0.00	0.09	0.00	0.00	0.98
Willow tit	0.00	0.00	0.09	0.00	0.00	0.98
	10.63	9.13	9.41	100.00	100.00	100.00

Table 4. Bird species breeding at the three sites, Pittington (P), Sherburn (S), Wingate (W). The first three columns show the density of territories at each site, the second three columns show the percent each species contributes to the total breeding population. (Jackdaw is not included).

4.1.3 The bird community at Wingate

During the census period at Wingate a total of thirty-four species were recorded. Of these twenty held territories; six were regularly encountered on the site, and four were seen on less than two occasions (Tab. 3).

A total of 152 territories was estimated, 62% of which were songbirds, 33% were Jackdaws, and 5% of which were other Corvidae and non-passerines (Fig. 3e). This is equivalent to an overall density of 14.00 territories per hectare, and a songbird density of 8.67 territories per hectare (Tab. 3).

The dominant species, excluding Jackdaw, was Willow warbler, which contributed 15.7% of the mapped territories.

4.2 The correlates of Jackdaw abundance

The dominance index (Berger & Parker 1970) for Jackdaws at Pittington and Wingate is 0.17 and 0.33 respectively. Because of the dominance of Jackdaws at Pittington and Wingate and the lack of this species at Sherburn, this species is considered here separately.

The colonies of breeding Jackdaws are associated exclusively with the areas of bare quarry face at Pittington and Wingate. They are also recorded feeding on the grassy areas of the quarry bottom. Jackdaws appear to colonise areas of quarry face that are at least 20m in height.

Wingate has a total length of quarry face of approximately 400m greater than 20m in height, Pittington has a total length of quarry face of approximately 200m greater than 20m in height, Sherburn in contrast has only 90m of quarry face still exposed, and this only reaches a height of approximately 9m.

It would appear from these brief details that the abundance of Jackdaws at these quarry sites is affected by the length and area of quarry face available for nesting. It would also appear that a certain threshold length and area is required before it becomes suitable for this species, and that this threshold is not surpassed at Sherburn as it is at the other two sites.

The methodology used in this study is most effectively related to species which are territorial and not colonial. Also the dominance of this species at two sites may mask some of the more subtle interactions of the remaining species. For these reasons Jackdaw is omitted from some of the following analyses.

4.3 Comparisons of the bird communities at each site

In order to compare the bird communities at the sites three techniques were used. Spearman's rank correlation coefficient to compare the list of breeding species at each site; the Shannon-Weaver diversity index to compare the diversity at the three sites; and the coefficient of variation to compare the variation in the density of individual breeding species between the sites.

4.3.1 Spearman's rank correlation coefficient

With the exception of Jackdaw, there were broad similarities between the breeding bird community at all three sites.

A non-parametric test of correlation was considered appropriate due to the log normal distribution of species abundance (Fig. 4), and the error involved in the estimation of species abundances.

To test the relationship between all three sites, the Spearman Rank Correlation coefficient (r_s) was calculated on all three combinations of site pairs. In all three cases the bird abundances were positively correlated between sites, all three being significant $P < 0.001$. (Tab. 5a).

4.3.2 Shannon-Weaver diversity index

The Shannon-Weaver diversity index H was calculated for each site, excluding Jackdaw (Tab. 5b). This is a relatively simple index that describes whether the individuals in a population are roughly evenly distributed among the species that make up that population or whether they are concentrated into a few dominant species (May 1975). It is also possible to calculate a variance of this index and thus make comparisons between the indices of the three sites.

This index has been criticised when used to compare communities as the relative effects of area are not taken into account (James & Rathbun 1981). In this case the similarity in site area allowed direct comparison of indices and the use of rarefaction curves was considered an unnecessary complication.

A comparison of the Shannon-Weaver index (Tab. 5b) reveals that the sites are similar in their diversity. To see if the small differences between the sites were statistically significant the variance associated with the index ($\text{Var } H$) was used as is described below.

4.3.3 Comparison of bird species diversity at each site

A t value was calculated for each of the three pairs of sites (Pittington and Sherburn; Pittington and Wingate; and Sherburn and Wingate) using the formula

$$t = H_1 - H_2 / (\text{Var } H_1 + \text{Var } H_2)^{0.5}$$

where H_1 is the diversity of site 1 and $\text{Var } H_1$ is its variance (Magurran, 1988).

The requisite degrees of freedom were also calculated using the formula

$$\text{df} = (\text{Var } H_1 + \text{Var } H_2)^2 / [(\text{Var } H_2)^2 / N_1] + [(\text{Var } H_1)^2 / N_2]$$

where N_1 is the number of individuals (territories) in site 1 (Magurran, 1988).

Consulting tables of the distribution of t reveals that there is no significant difference ($P > 0.05$) in terms of the diversity of bird territories occurring in them as measured by the Shannon index (Tab. 5c).

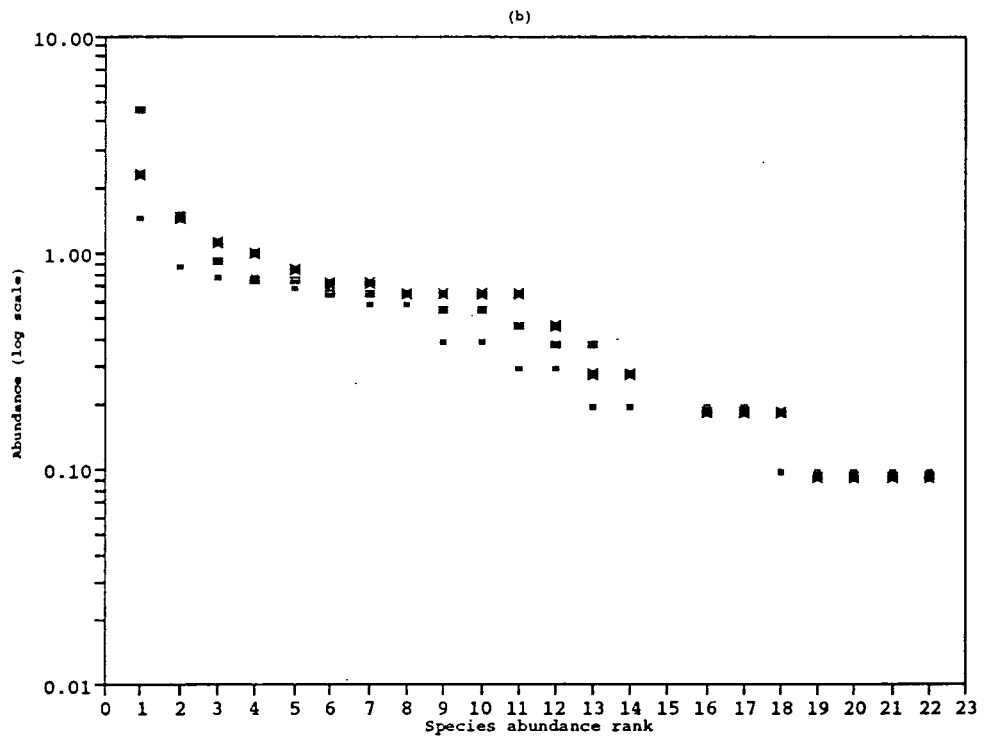
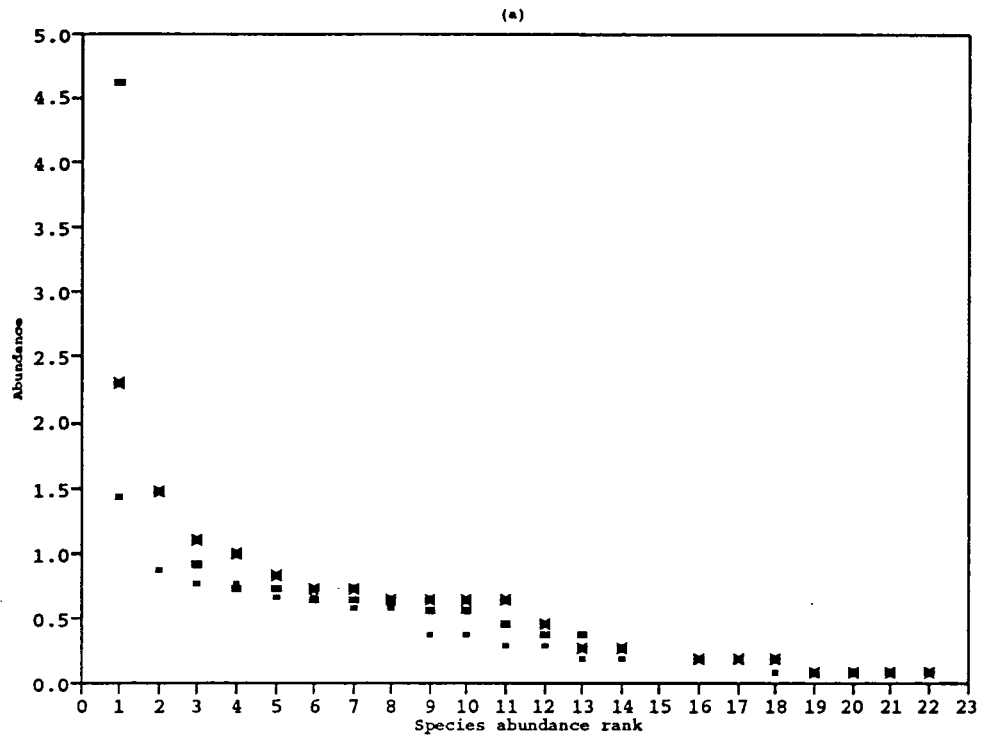

Figure 4. Plot of species rank against species abundance (a), and species rank against the log of species abundance (b), to demonstrate the fit of the log-normal abundance model. (n = 52).

Pittington - cross; Sherburn - horizontal lines; Wingate - vertical lines.

(a)

(n = 27)	Pittington & Sherburn	Pittington & Wingate	Sherburn & Wingate
Spearman's Rank coefficient	0.787	0.659	0.652
(r_s)			
<i>P</i>	<i>P</i> < 0.001	<i>P</i> < 0.001	<i>P</i> < 0.001

(b)

	Pittington (n = 116)	Sherburn (n = 95)	Wingate (n = 102)
<i>H</i>	2.75	2.76	2.74
Var <i>H</i>	4.7×10^{-03}	6.9×10^{-03}	4.7×10^{-03}

(c)

	Pittington & Sherburn (n = 116)	Pittington & Wingate (n = 95)	Sherburn & Wingate (n = 102)
<i>t</i> - value	-0.246	0.371	0.578
df	725	464	264
<i>P</i>	<i>P</i> > 0.05	<i>P</i> > 0.05	<i>P</i> > 0.05

Table 5. A comparison of the bird community between the three sites, using Spearman's Rank coefficient (a), the Shannon-Weaver diversity index (b), and a "t" test of the variation in the Shannon -Weaver index. Spearman's Rank Coefficient = (r_s); Shannon-Weaver diversity index = (*H*); The variance associated with the index = (Var *H*); Degrees of freedom = (df); Probability = (*P*).

4.3.4 The between site variation in individual species' density

To describe the relative variation between sites in the density of individual breeding species', the *coefficient of variation* (C) was calculated (Tab. 6) where C is the sample standard deviation divided by the sample mean, expressed as a percentage (multiplied by 100) (Snedecor and Cochran 1937).

This coefficient reveals that although a comparison of the diversity between the sites is insignificant, when the population is viewed as a whole; there is considerable between site variation in the density of certain species.

4.3.5 Patterns in variation across the sites

Considering only the 11 passerines that had a density > 0.4 at one or more sites (Tab. 5), 6 species have a value of $C > 15\%$ and 4 species have a value of $C > 45\%$ (Tab. 5).

The absence of Linnets and the low density of Dunnocks at Wingate; and the low density of Blue tits and Great tits at Sherburn are the most striking and will be addressed in further analysis.

More subtle patterns in variation are also apparent, the Linnet, Dunnock, Chaffinch, Blackbird, Great tit and Lesser whitethroat all have densities that decrease across the sites from Pittington to Sherburn. In contrast the Wren, Woodpigeon, Blackcap, Longtailed tit and Magpie all increase in density across the same sites.

The Pearson Product Moment Correlation coefficients between bird species territory occurrence reveal that of the 21 most common species recorded on the sites 80% were highly significantly correlated to the total number of territories recorded, ($P < 0.001$, 409 df). Only Skylark was negatively correlated ($r = -0.2721$, 409 df, $P < 0.001$); and Collared dove and Garden warbler density showed no significant correlation.

Areas of high productivity can be expected on theoretical grounds (MacArthur 1972) to support more species and for the majority of species taken across the sites as a whole this appears to be the case. However, the more subtle variations in density between quarries are not explained by this trend. The similar patterns between groups of species could be the result of similar causal factors, such as variations in habitat composition between the sites which is considered next.

Species	Density (territories/Ha)			Coefficient of Variation
	P	S	W	%
Willow warbler	1.47	1.44	1.48	1.19
Linnet	1.10	0.77	0.00	90.58
Dunnock	1.01	0.67	0.37	46.78
Chaffinch	0.82	0.77	0.74	5.66
Whitethroat	0.73	0.87	0.74	9.62
Robin	0.73	0.67	0.92	16.77
Yellowhammer	0.64	0.58	0.65	6.21
Blackbird	0.64	0.38	0.55	24.80
Blue tit	0.64	0.19	0.65	52.84
Great tit	0.64	0.10	0.55	68.03
Wren	0.46	0.58	0.65	16.92
Song thrush	0.27	0.38	0.18	35.62
Lesser whitethroat	0.27	0.10	0.00	112.80
Collared dove	0.27	0.00	0.00	173.21
Woodpigeon	0.18	0.29	0.46	45.12
Blackcap	0.18	0.19	0.28	23.70
Bullfinch	0.18	0.19	0.18	2.62
Longtailed tit	0.09	0.29	0.37	57.14
Skylark	0.09	0.19	0.00	101.62
Magpie	0.09	0.10	0.28	68.19
Carrion crow	0.09	0.00	0.00	173.21
Garden warbler	0.00	0.19	0.00	173.21
Reed bunting	0.00	0.10	0.00	173.21
Cuckoo	0.00	0.10	0.00	173.21
Treecreeper	0.00	0.00	0.18	173.21
Goldfinch	0.00	0.00	0.09	173.21
Willow tit	0.00	0.00	0.09	173.21
Total	10.63	9.13	9.41	8.20

Tab. 6. Number of territories of the breeding species at each site and the coefficient of variation, shown as a percent. Pittington (P) n = 116, Sherburn (S) n = 95, Wingate (W) n = 102.

4.4 Habitat description and classification

The environmental variables collected at each site were first assessed to establish which variables would best describe the three sites.

4.4.1 A summary of the variation in habitat variables between the sites

The percentage foliage in each of the five major habitat components at each site was assessed using the median and range (Table 7a). The median rather than the mean, is more suited to assessing the distribution of non-normally distributed data, such as percentage cover, and the range was considered the best estimate of the variation in the samples where the percentage values were estimated by eye to the nearest 5% in the field.

Grasses appear to be the dominant feature of all three sites, however this category includes grasses that were growing beneath the canopy and within scrub formations. At all three sites tree cover was present, either as hedge, scrub or wood in at least 59 % of samples (Table 7.b).

The species composition of the canopy (Table 8a), reveals that two species, hawthorn and ash, dominate, accounting for greater than 90% of the canopy species at all three sites. The composition of the ground vegetation (Table 8b), also shows little variation in species across the sites. Grasses are dominant at all sites, with no other single species accounting for more than 7% of the ground cover.

In view of the similarities in species composition of both the canopy and the ground vegetation at each site, a chi-square test was performed on the numbers of samples that were allocated to the eight different habitat types, arable, grassland, scattered scrub, scrub patches, scrub, mature scrub and woodland at each site. The result of the test (chi-square = 80.91, 14 df, $P < 0.001$) allows rejection of the null hypothesis that the frequency of occurrence of habitat categories is the same at all sites and implies there is a significant difference in the occurrence of habitat categories at each site. The result is also significant if the categories of arable and grassland are combined, to remove the obvious differences in the amounts of arable land on each site (chi-square = 72.34, 12 df, $P < 0.001$).

The differences between the sites are highlighted in figure 5. Sherburn being characterised by a high occurrence of scrub and mature scrub; Pitlington by a high occurrence of hedges and scrub patches; and Wingate by grassland, scattered scrub and woodland.

The habitats were categorised purely on their structural features, and this appears to be more effective in distinguishing between the sites. However it is felt that some of the changes in composition of the bird community across the sites may be due to a combination of factors, including plant species composition and structure. For this reason some of the more dominant plant species at each site were included as habitat variables in the analysis. The plant species retained as variables are hawthorn (*Crataegus monogyna*), ash (*Fraxinus excelsior*), gorse (*Ulex europaeus*) and brambles (*Rosa & Rubus* spp.).

(a)

Habitat	Pittington		Sherburn		Wingate	
	M %	R %	M %	R %	M %	R %
Canopy	6	0 - 100	3	0 - 100	6	0 - 100
Scrub	23	0 - 100	7	0 - 100	19	0 - 100
Grass	60	0 - 100	60	0 - 100	30	0 - 98
Herbaceous	5	0 - 70	5	0 - 90	10	0 - 100
Bare	0	0 - 50	0	0 - 100	10	0 - 90

(b)

Habitat Description	Pittington	Sherburn	Wingate
	%	%	%
Grassland	11.68	6.57	16.79
Arable	18.25	24.09	2.92
Hedge	16.79	7.30	13.87
Scattered Scrub	10.95	18.98	26.28
Scrub Patches	23.36	8.76	8.03
Scrub	10.95	13.10	6.57
Mature Scrub	2.19	13.90	8.76
Woodland	18.25	7.30	16.79

Table 7. Percentage foliage in the five major habitat formations at the three sites (a), median (M), and range (R) shown. Percentage frequency distribution of the 8 habitat types at each site (b) as defined in sect. 3.2. (n = 137) at each site.

(a)

Tree Species	Pittington		Sherburn		Wingate	
	%	SE	%	SE	%	SE
Cm	76.04	2.15	72.20	2.20	76.46	2.88
Fe	18.65	1.27	19.76	1.14	16.77	1.26
Sn	3.24	0.43	6.42	0.43	4.03	0.46
Ap	0.00	0.00	0.43	0.11	0.04	0.01
Sa	0.00	0.00	0.17	0.04	0.02	0.01
Others	2.07	0.47	1.03	0.11	2.08	0.26

(b)

Species	Pittington		Sherburn		Wingate	
	%	SE	%	SE	%	SE
Gr	57.45	3.20	54.14	3.26	54.29	2.77
Ru	4.46	0.84	7.36	0.97	1.86	0.23
Ro	2.13	0.30	5.55	0.75	1.63	0.17
Ud	0.45	0.18	1.57	0.37	2.41	0.58
Ue	6.12	1.35	3.74	0.82	0.35	0.15
Eh	1.22	0.60	3.72	0.19	8.92	1.20
Ap	0.70	0.24	0.64	0.14	2.03	0.38
Litter	13.47	1.56	12.61	1.73	11.42	1.32
Bare	3.26	0.83	6.12	1.47	12.90	1.32
Other	10.74	1.45	4.55	0.95	4.20	1.02

Table 8. Mean percentage of canopy contributed by the major tree species at the three sites (a),. Mean percentage of ground cover contributed by the major plant species and cover categories at the three sites (b). In both tables mean percentage cover (%) and standard error (SE) is shown. (n = 137 at all sites).

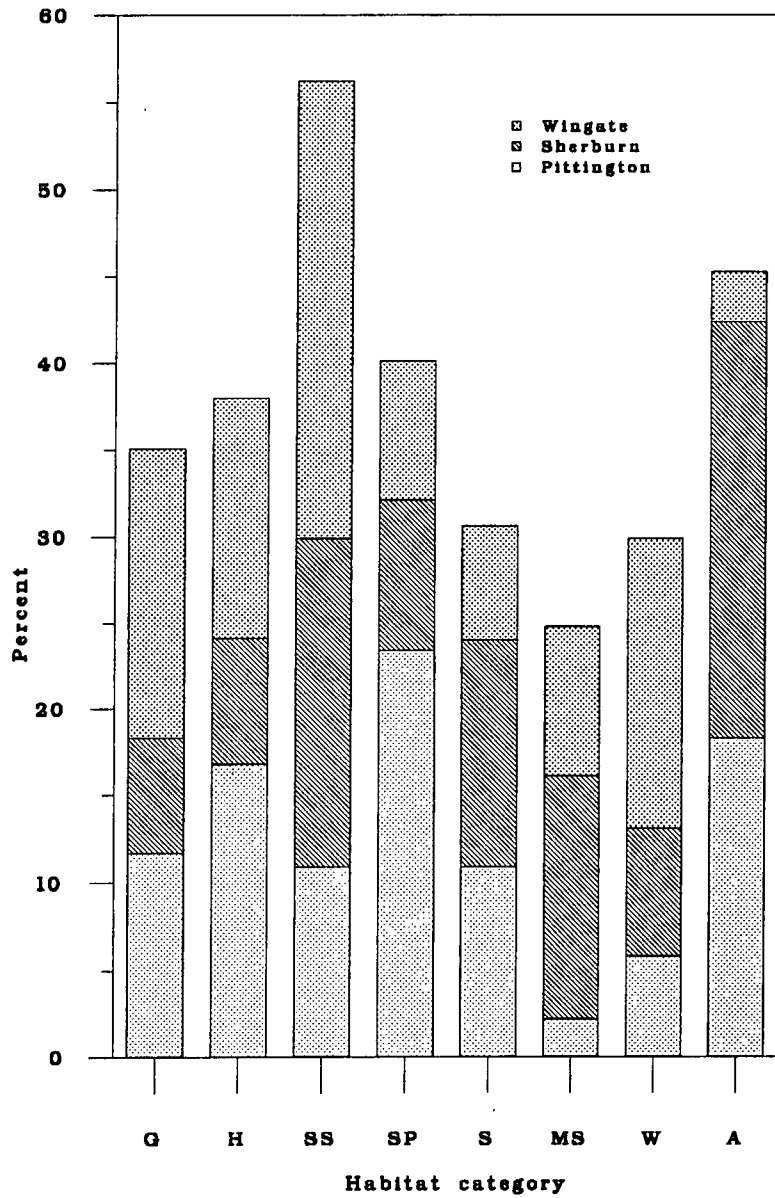

Figure 5. The frequency of occurrence of the eight habitat components at each site. Grassland (G), Hedges (H), Scattered Scrub (SS), Scrub Patches, Scrub (S), Mature Scrub, (MS), Woodlands (W), Arable (A). (n = 137 at all sites)

4.4.2 The distribution of bird territories in relation to available habitat

If the breeding birds are selective in their choice of habitats they will establish territories more frequently in the favoured habitat categories. The frequency of occurrence of a territory in the 8 habitat categories shows considerable differences from that which is available (Fig. 6). The results of a chi-square analysis of these differences was highly significant (chi-square = 120.87, 7 df, $P < 0.001$), allowing rejection of the null hypothesis that the territories occurred in each category at the same frequency the habitat category occurred in the environment. This confirms the pattern illustrated in figure 6, suggesting that the breeding birds on these sites are expressing a preference for the more enclosed habitats in which to establish and defend a territory.

4.4.3 Final choice of habitat variables

As a result of the preliminary investigation into the characteristics of the vegetation at the three sites, twenty-one variables were finally selected that were thought to best represent the habitats at the three sites and the differences between them (Tab. 9). Variables that were thought to be important in the distribution and abundance of birds, such as *Rosa* and *Rubus spp.*; other tree species; and tall herbaceous plants; but that did not occur frequently in the habitat sample units, were compounded into biologically sensible categories.

4.5 Multivariate data analysis

The data collected by the sampling procedure consists of two matrices of sample units. The sample units in both cases are the same, being the 411, 0.02 ha sample circles.

The first matrix contains the details of the presence or absence of a birds territory within the sample circle.

The second matrix contains the details of the habitat variables within the same sample circles.

A multivariate analysis of this data set was deemed appropriate as each sample is characterised by more than one species, and there is believed to be inter-correlated relationships between samples and species and so a technique is required that will treat the multivariate data as a whole.

The response of the individual species to the environmental gradient sampled is believed to be non-linear, each species having a set of optimum conditions at which its density will be greatest. The response of each species to this gradient is likely to be subtly different from one another, and so multivariate techniques based on unimodal or Gaussian response models will be used.

The initial aim of the multivariate analysis will be to condense the data set. This will be achieved by summarising the inherent redundancy, reducing noise, identifying outliers and finally elucidating relationships for further consideration (Gauch, 1982).

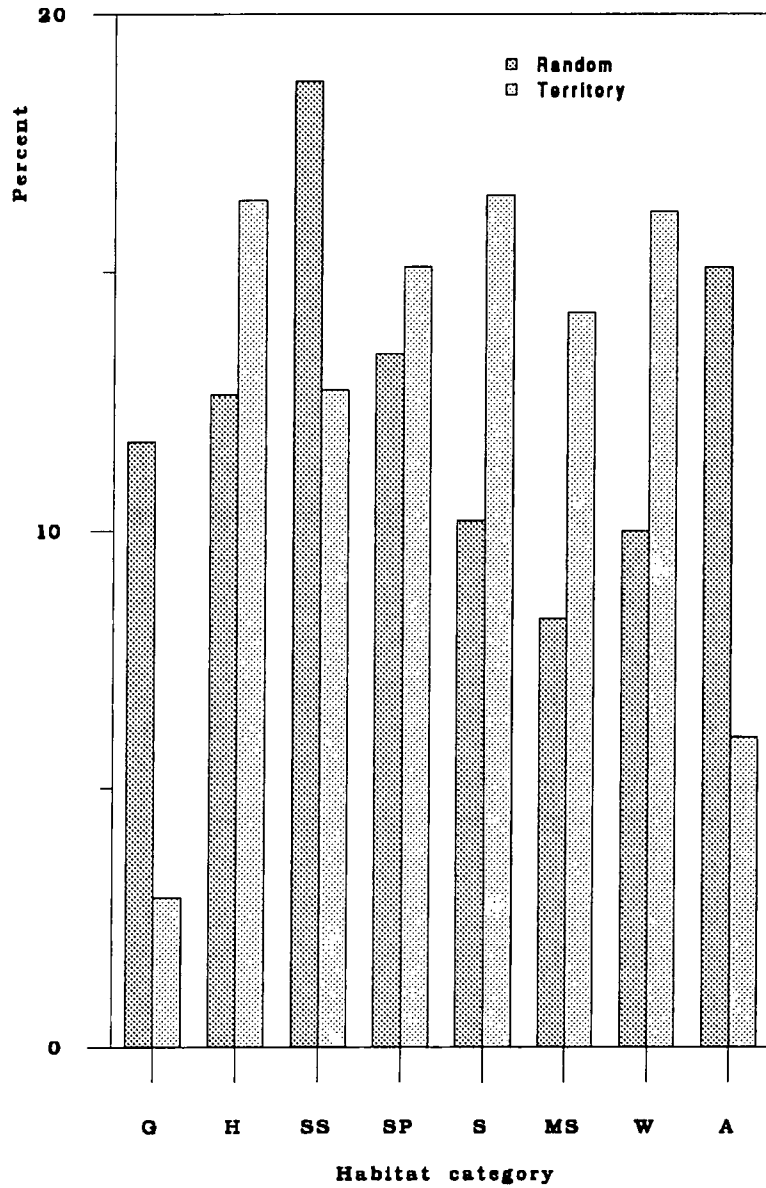

Figure 6. The frequency of occurrence of a territory (Territory) in eight habitat categories, compared to the availability of the habitat category in a random sample of the habitat (Random). Data pooled for all three sites, (n = 411).

Code for variable	Description of variable
Cm	Percentage cover of <i>Crataegus monogyna</i> .
Fe	Percentage cover of <i>Fraxinus excelsior</i> .
Other	Percentage cover of other tree species.
Total	Percentage cover of all tree species.
Can. max	Maximum canopy height in meters.
Can. per	Percentage cover by all tree and shrub species.
Shr. H	Percentage foliage volume, 5-10m.
Shr. M	Percentage foliage volume, 1.5-5m.
Shr. L	Percentage foliage volume, 0-1.5m.
Herb	Percentage foliage volume, 30-100cm.
Field	Percentage foliage volume, 0-30cm.
Litter	Percentage cover of leaf litter.
Bare	Percentage cover of bare ground.
Open	Percentage of open habitat.
Dense	Percentage cover of dense shrubs.
Hollow	Percentage cover of "hollow" shrubs.
Grass	Percentage cover of <i>Gramineae</i> .
Ue	Percentage cover of <i>Ulex europaeus</i> .
Tall	Percentage cover of tall annual herbaceous plants including <i>Epilobium</i> Spp., and <i>Urtica dioica</i> .
Ro/Ru	Percentage cover of <i>Rosa</i> and <i>Rubus</i> Spp.
Ect	Distance in meters to the nearest ecotone

Table 9. Definition of the final twenty - one habitat variables found to best represent the variation between sites, and thought most likely to effect the distribution and abundance of the breeding bird species. All percentage covers were estimated to the nearest 5% in the field.

4.5.1 TWINSpan analysis.

As a preliminary step in the analysis of the bird territories, the sample units were classified on the basis of their species composition using TWINSpan (Hill, 1979). This is a hierarchical classification technique, which examines overall gradients in the data. These gradients are used as a basis for the division of the samples into clusters (Gauch, 1982). This has advantages over other classification techniques which cluster on the basis of similarities because community data small differences in species composition are more likely to be the result of "noisy" data than of community gradients.

The results of a TWINSpan classification of the bird samples are presented in the form of a dendrogram (Fig. 7). The classification is arranged such that similar groups of samples are close together in the dendrogram.

Four final groups were recognised (C, E, F, and G), further divisions were computed but were not thought to be helpful in summarising the data.

The first division splits the sample units primarily on the presence or absence of Yellowhammer and Linnet, 85% of the samples being allocated to Group A, indicated by Yellowhammer and Linnet. The remaining 15% are allocated to Group B, indicated by the presence of Chaffinch, Robin, Wren, Blackcap, Blue tit, Woodpigeon, Willow warbler, Great tit, Long-tail tit, Blackbird, Song thrush and Bullfinch. These species are still represented in Group B, though to a lesser extent.

The second division further divides Group B, the indicator species for Group C are Song thrush, Robin, Willow warbler, Linnet, Lesser-whitethroat and Wren. There are no indicator species for Group D. Once again the division is asymmetrical, with 69 of the samples remaining in Group D.

The third division divides Group D into similar sized samples, Group E (33%), and Group F (36%). The two groups differ primarily in the proportions of Linnets. Group E is indicated by Linnet and contains the majority of the samples in which Linnet was present. Group F, by contrast contains only 3 samples containing Linnet and is indicated by species more usually associated with enclosed canopies such as Blue tit, Great tit, Robin and Wren (Fuller, 1982).

The first point of interest is that even after three divisions 226 samples or 69% of the data set are still clustered in two end-groups E and F. This would appear to indicate the overall homogeneity of the community, with the clusters that are fragmented off representing relatively uncommon fractions of the community.

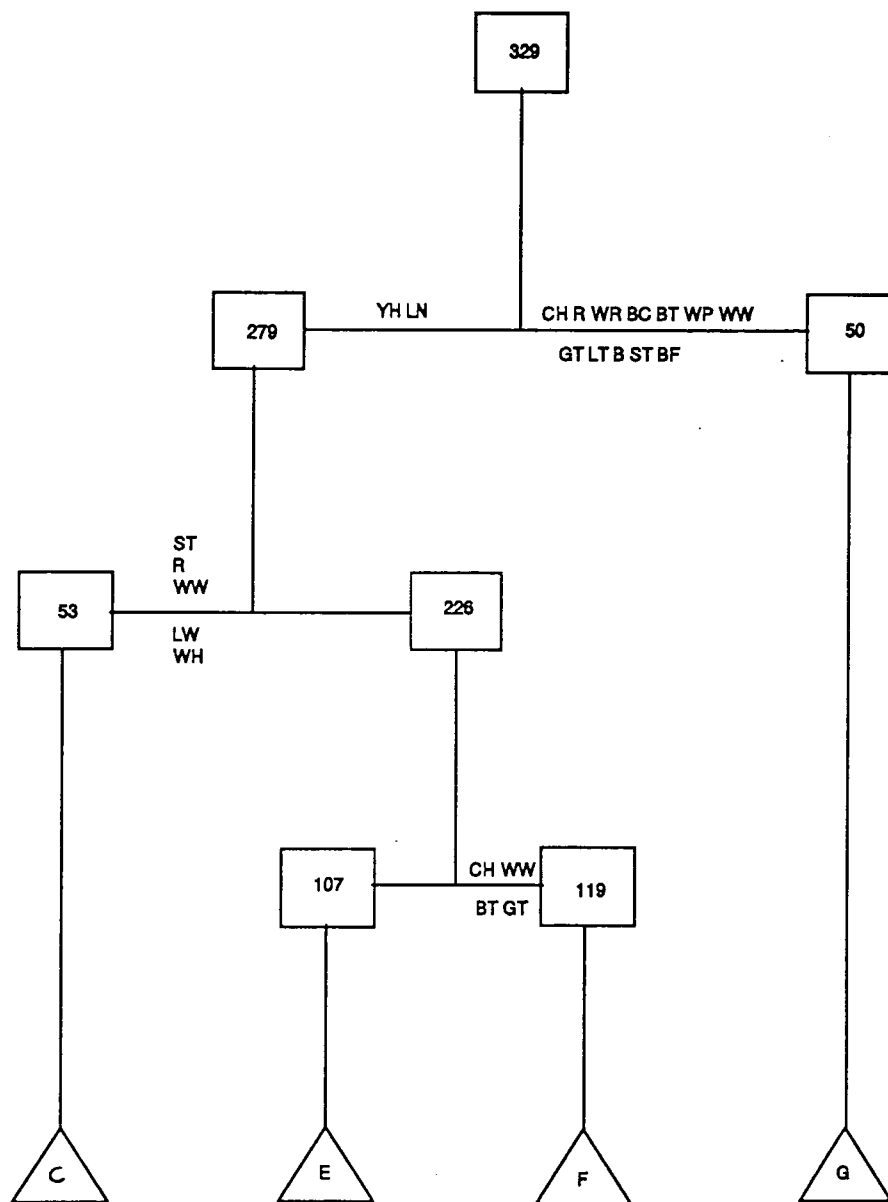

Figure 7. Dendrogram representing the major divisions of a TWINSpan classification of the sample units according to their bird species composition. Figures in the triangles are the final group labels; figures in boxes are the numbers of samples in each subdivision. Indicator species codes are given in table 2. Negative indicator species appear on the left of each division and positive indicator species on the right.

There is an apparent environmental gradient that could be associated with the divisions. The species with larger territories utilising more of the open ground such as the Linnet, Whitethroat and Song thrush in end-groups C and E; and the species more usually associated with woodland in end-groups F and G. However this gradient is not clear and other factors appear to be clouding the interpretation.

Further divisions and end groups were computed but these appeared to fragment the samples on the basis of the presence or absence of a few uncommon species or samples. This was not an aid to understanding the data and so further divisions are not shown.

4.5.2 Ordination of data

Ordination serves to summarise community data by producing a low dimensional ordination space, in which similar species or samples are close together and dissimilar entities are far apart (Gauch, 1982).

Detrended correspondence analysis (DCA) is an ordination technique that searches for axis of maximum variation within the data. It avoids the arch effect (Gauch, Whittaker & Wentworth, 1977), whereby the second and subsequent ordination axes are distorted by systematic relation to the first by detrending (Hill, 1979). The computer program DECORANA detrends by segments. This has been found to flatten out some of the variation associated with one of the underlying gradients (Ter Braak, 1988). Detrending by polynomials is a more stable method of detrending and has been incorporated into the computer program CANOCO (Ter Braak, 1988).

The output from this program gives sample and species scores that can be plotted on ordination axis, and eigenvalues, a number between 0 and 1; the higher the eigenvalue the more important the ordination axis; multiplied by 100 it is usually referred to as the "percentage variance accounted for" by the axis (Ter Braak, 1988). For interpreting the ordination axis one can use the canonical coefficients and the intraset correlations. By looking at the signs and the relative magnitudes of these factors, we may infer the relative importance of each environmental variable for predicting the community composition (Ter Braak, 1986). By running the program on several occasions with a variety of inputs one can monitor the effect that changes in the input are having on the output values. In this way correlated and redundant variables can be omitted without compromising the efficiency of the final ordination. This helps to prevent the construction of overly complicated and difficult to interpret axes (Johnson 1981). If the eigenvalues and species environment correlations drop considerably, one has removed too many or the wrong variables (Ter Braak, 1986).

4.5.3 Identification of outliers

On the first run of CANOCO the DCA option was selected with no down-weighting for rare species. All 21 species and 411 samples were entered, CANOCO subsequently removes all the sample

units in which no species territory was recorded, and so the final analysis was performed on the 367 sample units in which at least one species' territory was recorded.

The eigenvalues for the first run were exceptionally high, being 0.826, 0.346, 0.267 and 0.238 for the axis 1-4. However, a plot of the six axes combinations (Fig. 8) reveals that the gradients identified are due predominantly to the outlier Skylark, and the uncommon species Garden warbler, Treecreeper and Collared dove.

These species are deleted from further runs of the program, the justification being that their relationships to other samples in the data set are not sufficiently expressed in the data to allow meaningful analysis.

In the case of the rare species this is because there is insufficient occurrences (6) to convey any real detail of the community relationships and these samples are separated from the rest of the data.

In the case of the outlier Skylark, the gradient detected from scrub to arable is already understood, and the scale it imposes on the rest of the data reduces considerably the information that can be conveyed by other species.

4.5.4 Ordination of species

Having removed the outliers and rare species the remaining samples ($n = 329$) and species ($n = 17$) were entered into CANOCO and a DCA performed.

The eigenvalues were reduced considerably from the first ordination to 0.371, 0.262, 0.235 and 0.206 for axes 1-4. However the ordination showed far more clearly the relationships between the more common species (Fig. 9a).

The first axis shows a gradient from a cluster of species normally associated with enclosed canopy or woodland such as Woodpigeon, Blackcap, Wren, Blue tit, Great tit and Chaffinch, through to species of more open scrub habitats, such as Whitethroat, Linnet and Yellowhammer. An environmental interpretation of this axis would therefore be one of succession from open areas of recently quarried ground (loaded positively on axis 1) through to the woodland climax dominated by ash (loaded negatively on axis 1). This appears to be similar to axis 2 in the first ordination, however in this ordination the absence of outliers has allowed the relationships between remaining species to be more easily seen.

Axis 2 is less easily defined, but appears to relate to a gradient from habitats containing a large proportion of dense cover in the lower scrub layer. The type of habitats envisaged are those provided by *Rosa* and *Rubus* and other forms of dense herbaceous growth, such as occurs both inside and outside the canopy. At one end of the gradient (loaded positively on axis 2) is Whitethroat, a bird of low dense scrubby habitats (Simms, 1985) and at the other (loaded negatively on axis 2) are species such as Lesser whitethroat, and Song thrush. These species are more usually associated with habitats with more vertical structure in which to nest and use as song-posts. The Lesser whitethroat uses trees as a perch from which to sing, unlike the closely related Whitethroat which advertises the extent of its territory in an elaborate song-flight (Simms 1985).

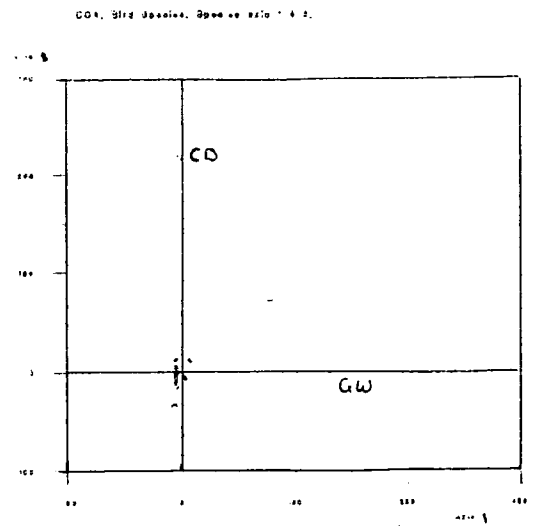
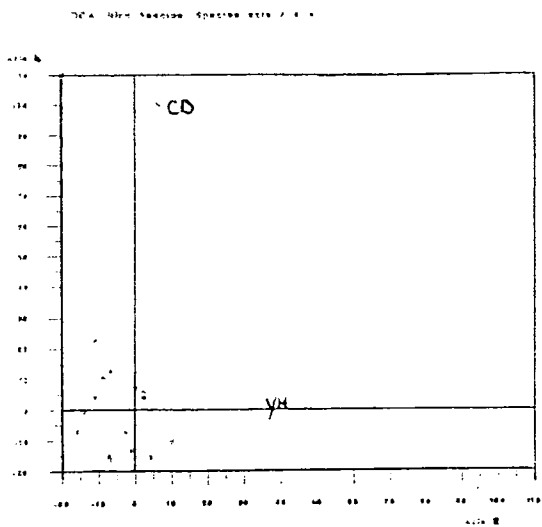
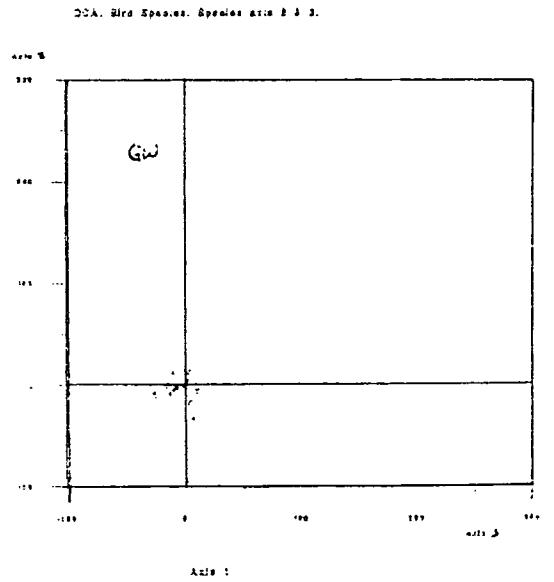
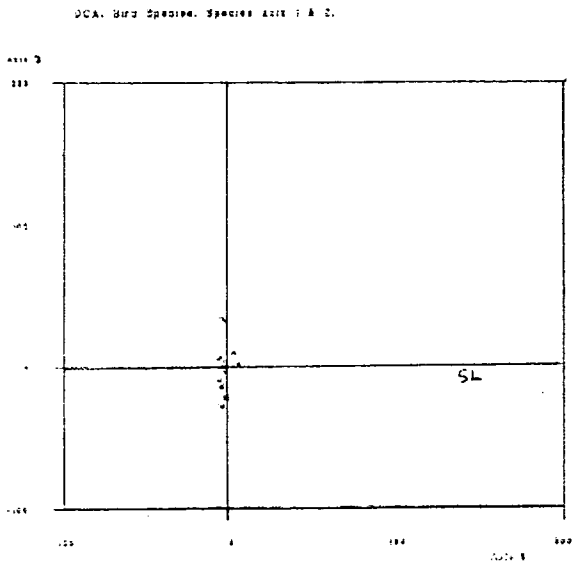
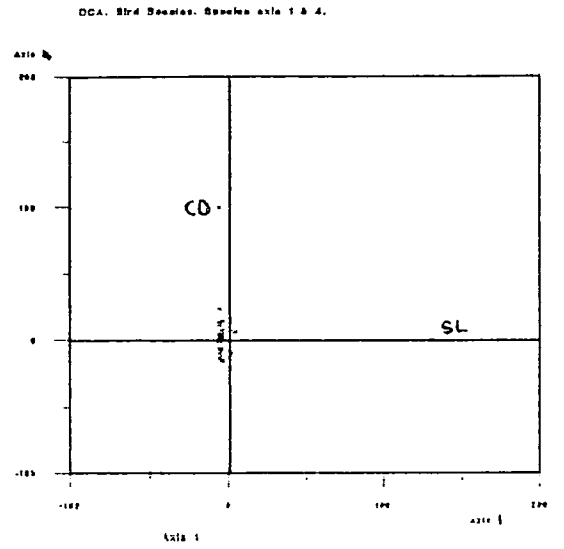
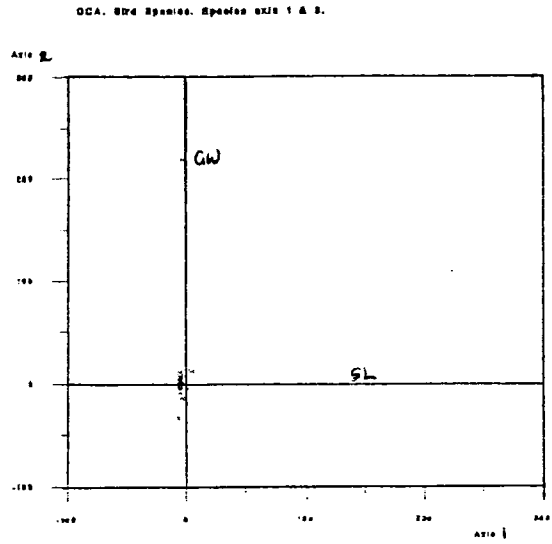

Figure 8. A plot of the six axes combinations of the species scores obtained from the first DCA ordination used to identify the outlying and rare species. Species codes given in table 2. (n = 411).

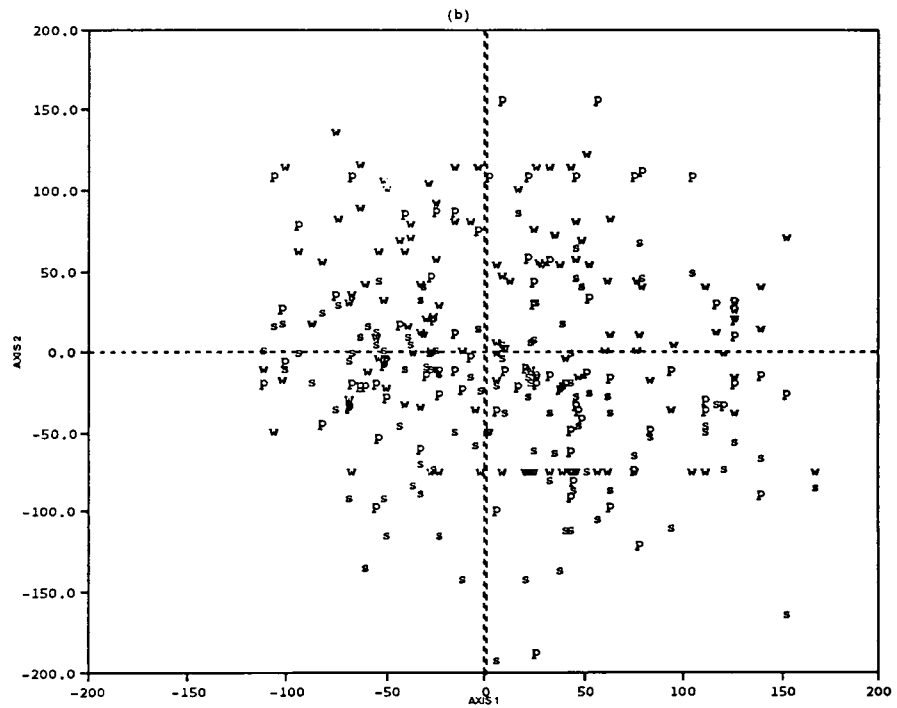
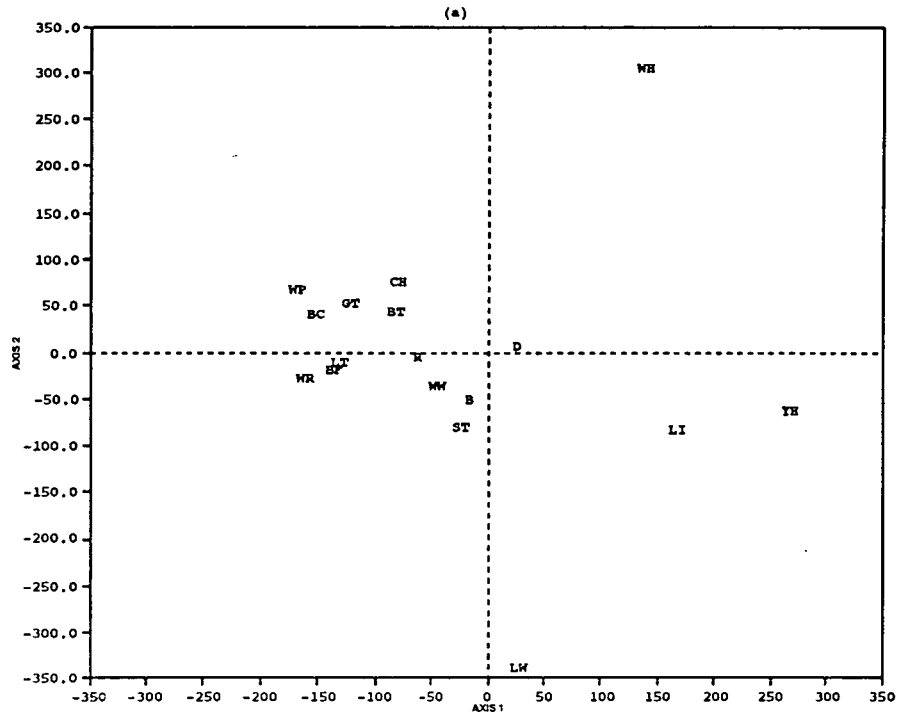

Figure 9. A plot of the species scores (a), and the sample scores (b), for the first two axes of the final DCA ordination. Bird species codes are listed in table 2. P = Pittington; S = Sherburn; W = Wingate. (n = 329).

The other species in the ordination are not so well separated by axis 2. The Blackbird, a member of the same family as the Song thrush and also predominantly a ground-feeder, is positioned in the ordination near the Song thrush on the "less dense herb-layer" end of the axis. However, the Chaffinch, an excellent example of a bird of the closed canopy (Fuller 1982), is at the opposite end of this axis. This would appear to indicate that this species is showing some association with closed canopy (due to its position on the first axis) in which there is a well developed field layer (due to its position on the second axis).

These results to some extent reflect those of the TWINSPLAN analysis in clustering the majority of the community quite tightly with the most obvious gradient being that on axis 1, from closed canopy scrub to open grassland.

4.5.5 Ordination of samples

The sample scores (Fig. 9b) are quite tightly clustered at the centre of the ordination. Two patterns are however apparent. The three sites appear to be separated to a limited extent. The samples from Wingate are clustered towards the top of the ordination, Sherburn towards the bottom and Pittington in the centre. This reflects the pattern in occurrence of plant species found in the site summaries (Tab. 8), in which there was a gradient in the percentage cover of species associated with a well developed field layer (*Rubus* & *Rosa* spp.), from Sherburn, which had the most cover in this category, through Pittington to Wingate.

A further pattern is the two groups of distinct outlying points with high values on axis 1 and 2 respectively. Those that score high on axis 2 are samples containing Whitethroat only or Whitethroat and one other species. Those that score high on axis 1 are samples containing Yellowhammer only, or Yellowhammer and one other species.

4.5.6 Percent variation explained

The first two axes explain 52% of the variation in the data, and the species environment correlations (Tab. 10a) which are the correlation coefficients between the environmental variables and the species axes consisting of the sample scores (Ter Braak, 1988) demonstrate that this variation is correlated to the environmental variation measured. In contrast axis 3 and 4 explain only a further 12 % of the variation and this is not strongly correlated with the environmental variables measured, as shown by the biplot scores on axis 3 & 4 (Tab. 10b), the range being relatively small when compared to axis 1 & 2. Axis 3 and 4 were also extremely sensitive to removal of one or more samples. For these reasons it was felt they did not aid the interpretation of the data and so they were not considered further.

(a)

DCA axes

Environmental Variable	Axis 1	Axis 2	Axis 3	Axis 4
Fe	-312	-2	-21	28
C.max	-524	71	-25	8
Shr.H	-433	53	-17	17
Shr.M	-329	-13	37	-27
Shr.L	-203	-77	11	16
Herb	18	120	32	-5
Field	97	79	-38	-34
Litter	-237	-80	46	20
Open	309	73	-42	2
Hollow	-319	-15	47	-45
Grass	283	-17	-5	21
Ue	80	-139	44	40
Ro/Ru	57	12	58	58

(b)

DCA axes

Environmental Variable	Axis 1	Axis 2	Axis 3	Axis 4
Fe	-151	-2	-21	28
C.max	-253	71	-25	8
Shr.H	-209	53	-17	17
Shr.M	-159	-13	37	-27
Shr.L	-98	-77	11	16
Herb	9	120	32	-5
Field	47	79	-38	-34
Litter	-114	-80	46	20
Open	149	73	-42	2
Hollow	-154	-15	47	-45
Grass	137	-17	-5	21
Ue	38	-139	44	40
Ro/Ru	27	12	58	58

Table 10. Inter-set correlation's ($r \times 1000$) (Ter Braak 1988) between environmental variables and sample axes (a), and the biplot scores of the environmental variables (b) from the DCA ordination of the combined data from the three sites. ($n = 411$).

4.5.7 Relationships between ordination and environmental variables

Following exploratory analysis of data by a DCA ordination, which extracts the dominant pattern of variation in community composition, the next logical step is to attempt to relate this pattern to the environmental variables (Gauch 1982). Often this is attempted through the use of indirect gradient analysis, whereby the ordination axes are related to the measured environmental variables in a separate process (Fuller & Henderson, 1992). More recently the process of gradient analysis has been incorporated into ordination techniques (Ter Braak, 1986) in an analysis called canonical correspondence analysis (CCA).

In this technique, a multivariate direct gradient analysis is performed, whereby a set of species is related directly to a set of environmental variables. This identifies an environmental basis for community ordination by detecting the patterns of variation in a community composition that can be explained best by the environmental variables measured (Ter Braak, 1986). In this sense the ordination is "constrained" by the environmental variables. In the resulting ordination diagrams, species and site scores are represented by points and environmental variable scores are represented by arrows (Ter Braak, 1986).

The statistical significance of the eigenvalues can be calculated by randomly permuting the sample numbers in the environmental data. The environment data are randomly linked to the species data, thereby giving rise to a random data set (Ter Braak 1988). For each random data set, an eigenvalue can be calculated for the first axis and for the sum of the eigenvalues for all the axes (the trace) in the same manner as it is for the real data set. From these values the probability of the random eigenvalues exceeding the real eigenvalues is calculated and this confers a degree of statistical significance to the results.

The computer program CANOCO offers CCA as an option for analysis. The arch effect in CCA is more elegantly removed simply by dropping superfluous environmental variables (Ter Braak, 1987). Variables that are highly correlated with the "arched" axis are the most likely to be superfluous. If the number of environmental variables is small enough for the relationship of individual variables to the ordination axes to be significant, the arch effect is not likely to occur at all (Ter Braak & Prentice, 1988).

The data matrixes that were to be used in this part of the analysis were the 400 samples by bird species presence and absence matrix; and the environmental variables measured in the sample circles also contained in a 400 sample by 21 environmental variable matrix.

4.5.8 Removal of correlated and superfluous environmental variables

Before detailed analysis of the CCA was undertaken, superfluous and highly intercorrelated variables were removed. This was achieved by running the program on a number of occasions whilst monitoring the output of the eigenvalues, species-environment correlations, fraction extracted and fraction explained by the axes (Fig. 10).

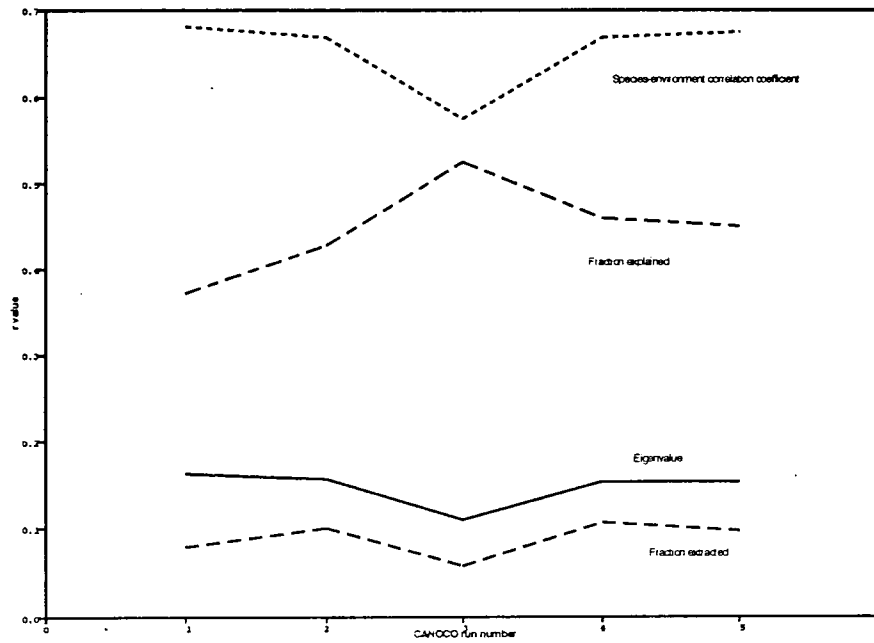

(b)

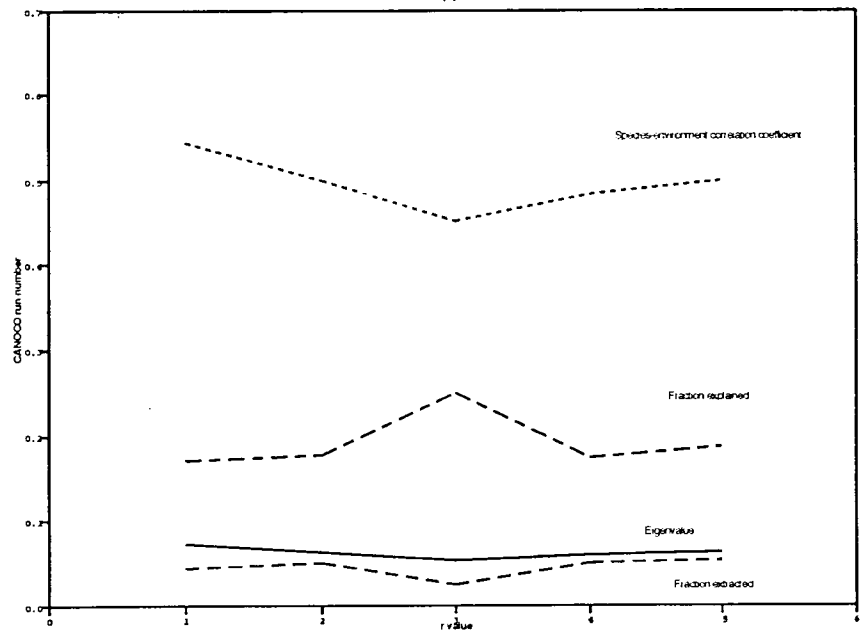

Figure 10. A graphical representation of the output from CANOCO for axes 1 & 2 (a), and 3 & 4 (b). Run 5 was chosen as it had the lowest number of variables (13) and the highest values for the species-environment coefficient, the fraction explained, the eigenvalue and fraction extracted

Variables were removed that were highly correlated with many variables in the Pearson product moment correlation matrix (appendix), and subsequently scored high values in the weighted correlation matrix, and values approaching zero in the canonical coefficients table calculated in the CCA analysis.

A summary of this process is shown in Figure 10. The first run was with all variables included. The second and third runs were for structural variables only and then species variables only. Subsequent runs remove some structural and some species variables from the complete variable list. After 5 runs it can be seen that the eigenvalues and correlations are maintained at an acceptable level, whilst reducing the number of variables from 21 to 13, from run 1 to 5. The low values for the species-environment correlations obtained in run 4 are the result of removing too many variables. This run was completed with only 7 species as habitat variables, and demonstrates the effect of the removal of too many or the wrong variables.

Finally, it was decided that the inclusion of 13 of the original variables conveyed best the relationships between the bird community and the environmental variables measured. The variables that were retained were "Fe, C.max, Shr.H, Shr.M, Shr. L, Herb, Field, Litter, Open, Hollow, Grass, Ue, Ro/Ru" (for a more complete definition see table 9).

4.5.9 Constrained ordination

The eigenvalues for the first two axes of the constrained ordination (0.155 and 0.064 respectively) were considerably less than those obtained in the unconstrained (DCA) ordination, indicating that a relatively high proportion of the community variation remains unexplained. The fraction extracted by the four primary axes were 9.7%, 5.5%, 1.2% and 0.8% respectively. However, the intersite correlation coefficients indicate similar axes as those defined by DCA, and the species ordination biplot (Fig. 11) also identifies similar axes to those extracted by DCA. This suggests that the original data contain a high proportion of random variation (Bates 1992).

4.5.10 Species ordination and biplot scores

The first two axes as defined by CCA (Fig. 11) are very similar to those obtained by DCA, however they are a mirror image of each other. The axes have been "flipped" this does not effect the interpretation of the scores, whose positions, relative to one another, remain very similar to those obtained in the DCA ordination.

Axis 1 has strong positive correlations with maximum canopy height and high foliage volumes in the high shrub category. This is very similar to the interpretation applied to axis 1 in the DCA ordination. The variables most strongly associated with this axis are those that relate to a gradient of increasing canopy height and density (C.max, Shr.H, Fe, Hollow and Shr.M.). An overall interpretation of the combination of environmental variables of this axis would be one of the successional sequence

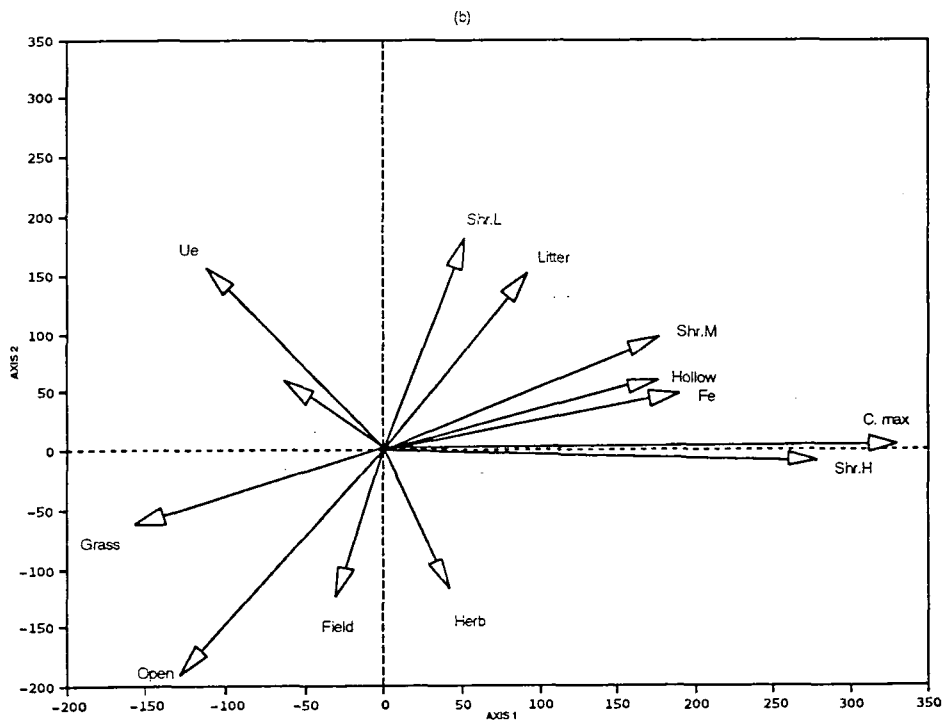
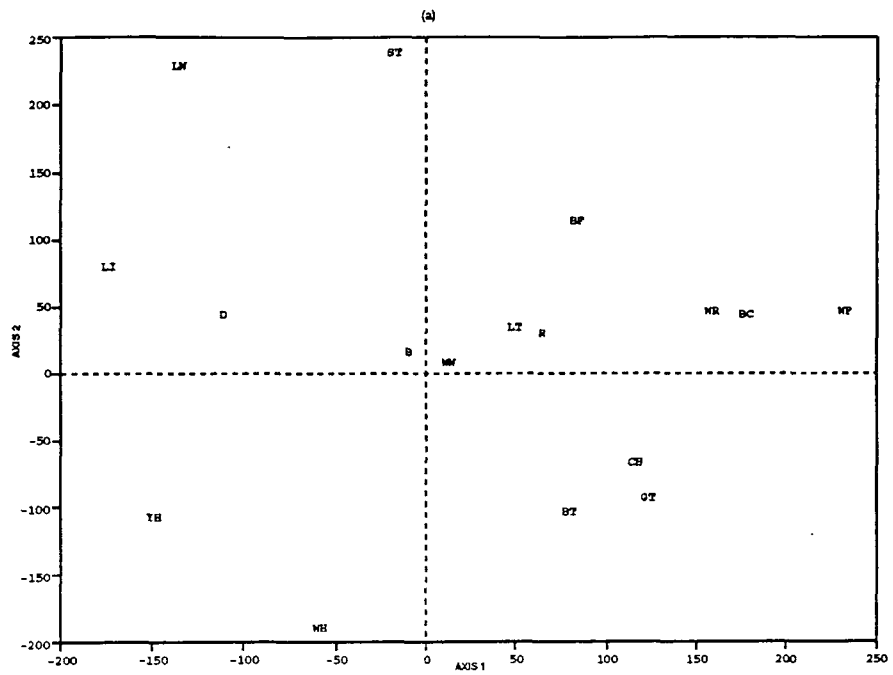

Figure 11. Plot of the species scores (a), and sample scores (b), for the first two axis of the final CCA ordination. Habitat variables are described in sect. 3.2. Bird species codes are listed in table 2. (n = 411).

seen in the quarries from open quarry, or limestone grassland to the climax woodland community dominated by ash.

The bird species are arranged along this axis according to their associations with the measured variables. The positions at which they are plotted represent the hypothetical "optimum environment" for that species in response to the changes in the habitat, as represented by the axis variables.

The Whitethroat, Linnet, Dunnock and Yellowhammer are all situated at the negative end of the axis, associated with the more open habitats of the early successional phases of the quarries. As one moves along the axis, hypothetically into the more enclosed habitats of scrub, the first species to appear are the Blackbird, Song thrush and Willow warbler. As one moves further along this axis a greater number of species, more usually associated with closed canopy scrub or woodland, are added to the community, for example the two *Paridae*, Chaffinch, Longtailed tit and Bullfinch. Finally at the extreme positive end of this axis are the Woodpigeon and the Blackcap, both truly "woodland" species (Fuller 1982).

Axis 2 is not so well defined. It is positively correlated to the variables Shr.L, and Litter. These represent a high foliage volume in the low shrub category (0-1.5m) and a well developed litter layer. It is also negatively correlated with the variables, Field, Open and Herb. These represent habitats with a well developed herb and field layers which are fairly open. An overall interpretation of the combination of environmental variables of this axis would also be one of a successional gradient. This gradient differs from that of axis 1 in that it starts with a well developed field layer due to tall herbs and other annual plants such as *Epilobium* and *Urtica* spp., rather than the bare quarry of axis 1. The end of this gradient is also different as it appears to end in a sub-climax, in which succession is arrested before the habitat is dominated by canopy species such as ash. The shrub species that do colonise, such as gorse brambles and hawthorn, are not allowed to develop into a tall dense canopy, but maintained as low shrub. In this respect this axis could be view as a "grazing or management" gradient, with the negative end representing very little management by cutting or grazing and the positive end representing a high management input, either by grazing or selective removal of encroaching scrub.

The bird species are quite widely separated by axis 2 (Fig. 11). Whitethroats and Yellowhammers are associated with the open habitats, the Whitethroat with open habitats in which the field layer is well developed. The Linnet and Dunnock are associated with a greater degree of succession on this axis, in particular with the development of gorse and bramble scrub. At the extreme positive end of this axis, representing the final stage of the sub-climax, are the Song thrush and Lesser whitethroat. The wide separation of the two Sylvid warblers by this axis is in keeping with the interpretation of a less well developed field-layer. These two species are reported to show distinct preferences in this respect, the Whitethroat favouring a well developed field layer in which to nest and forage, the Lesser whitethroat favouring a more well developed scrub with more vertical structure (Simms 1985). This together with the presence of the Song thrush at the same extreme on the axis; a species well known for its use of tall song-posts; suggests that although the canopy development is arrested during the succession represented by this axis, the development of vertical structure, perhaps in the form of a few well spaced trees, is allowed to continue.

The species that are associated with the developed canopy show less separation on axis 2. Two groups of species do emerge. The first is the Bullfinch, which shows an association with Shr.L and Litter. This indicates that this species prefers habitats in which the canopy is closed, but is dominated by scrub species, such as hawthorn rather than the canopy species, such as ash. The second group is the Blue tit, Great tit and Chaffinch. These species are also associated with the "closed canopy" end of the first axis, but on the second axis are more closely associated with areas of well developed field layers. This indicates areas such as clearings and woodland edge, where there is sufficient light penetration for the field layer to develop.

The position of Willow warbler and Blackbird at the centre of the ordination represents the ubiquitous nature of these species at the chosen sites. The mixture of dense scrub and open areas appear to suit both these species which were well represented at all sites.

4.5.11 Sample ordination and biplot scores

The samples are widely scattered around the ordination plot (Fig. 12). One interesting pattern that emerges is the relative lack of points from Wingate that fall in the upper left quarter of the ordination. It is this quarter that contains Dunnock and Linnet, species either absent or poorly represented at Wingate. This quarter is represented by the biplots of Ue (gorse) and Ro/Ru (combined *Rosa* and *Rubus*), suggesting that the absence or low occurrence of these variables at Wingate may account for the low densities of these species.

Patterns of clusters between the sites are not clearly defined, though there is some clustering of sites. Wingate is most prominent in the lower half of the ordination particularly, the lower left quadrant. This area represents the earliest successional phase on both axes and is the most species poor in terms of the bird species ordination (Fig. 11). Sherburn is quite tightly clustered around the centre of the ordination, representing a site in mid-succession on both axes. Pittington is most prominent in the upper left quadrant of the ordination, representing an open site on the first axis, but in the final phase of the sub-climax as represented by the second axis.

4.5.12 The statistical significance of the constrained ordination

A Monte Carlo permutation test was carried out on the results of the final CCA ordination to test the significance of the relationships described by the measured environmental variables. The first eigenvalue (0.155) is significant ($P < 0.01$, Monte Carlo test) and so there is evidence for a statistical relation between the bird distribution and the environmental variables measured by the first ordination axis. The overall or trace eigenvalue was also significant ($P < 0.01$, Monte Carlo test) and so there is also evidence for a statistical relation between the bird distribution and the environmental variables measured on the second ordination axis.

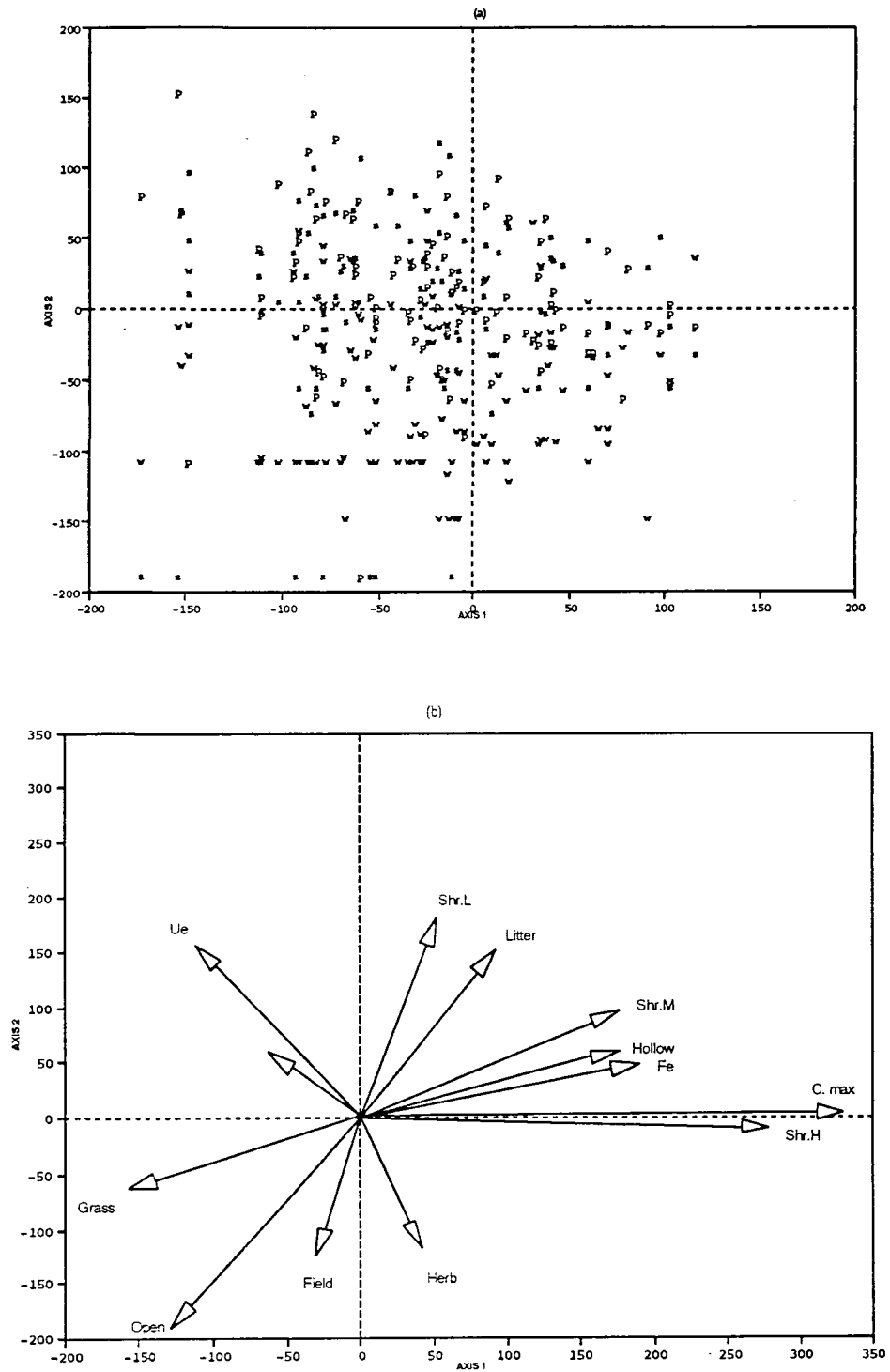

Figure 12. A plot of the site scores (a), and the biplot scores of the environmental variables (b), for the first two axes of the final CCA ordination. Habitat variables are described in sect. 3.2. P = Pittington.; S = Sherburn; W = Wingate. (n = 411).

4.6 Behavioural results

The most striking feature of the census results was the extremely large variation between some common species across what are essentially three similar sites, holding similar bird communities. The constrained ordination demonstrates the overall similarity of the sites and the species at the sites. Although environmental gradients were detected and the bird distribution was significantly correlated to these gradients, it is still not clear why the birds are responding to the habitat variables measured, whether they are used for nesting, foraging or some other activity. The behavioural analysis was designed to explore the use each species makes of the selected habitat variable or variables.

4.6.1 A summary of the behavioural records.

A total of 45 species were recorded during the behavioural observations, and these included all of the species for which territories had been estimated. Due to the strict criteria applied to recording behavioural observations (see methods), behavioural records were only made for 28 species (Tab. 11).

A total of 1821 behavioural observations were recorded, 47% of the observations were males, 17% females and 36% were of indeterminate sex. Less than 1% were juveniles.

Birds were recorded in 14 species of plant and in 3 other categories (Tab. 11), 77% of these records were in 4 genera; hawthorn, grasses, ash and *Epilobium* spp. A further 6.5% were recorded on leaf litter.

4.6.2 Habitat use

Having established that more territories occur in the enclosed habitats on the sites, (sect. 4.4.2) it was decided to investigate the use that the birds were making of the different habitats. The birds also appear to favour certain habitats in which to forage and carry out other activities when compared to the available habitats (Fig. 13) and there are differences between foraging and other uses. These differences are statistically highly significant, (chi-square = 273.368, 14 df, $P < 0.001$). Grassland, in contrast to its low occurrence in territories, is used during foraging at a similar frequency to its availability. In contrast arable fields feature very infrequently in any behavioural records, indicating their apparent unsuitability for foraging or other activities. Two categories scrub and mature scrub stand out as being most frequently used, particularly in comparison with the availability of these habitats within the sites. The differences between the territorial use and foraging use arise from at least two distinct sources. First the foraging records include those of species that were not recorded as holding territories on the sites, such as Starling and Grey partridge. These two species in particular utilised the grassland whilst foraging. Second, certain species, in particular the Linnet, defend small territories grouped into colonies and forage outside these territories as flocks (Newton 1972). In addition to these sources, the

(a)		(b)	
Bird species	Number of behavioural records	Plant species	Number of bird observations
Willow warbler	279	<i>Crataegus monogyna</i>	881
Whitethroat	176	<i>Gramineae</i>	226
Jackdaw	147	<i>Fraxinus excelsior</i>	198
Blackbird	118	<i>Litter</i>	121
Robin	117	<i>Epilobium hirsutum</i>	104
Linnet	116	Cliff	71
Tree-creeper	105	<i>Rosa spp.</i>	62
Longtailed tit	94	<i>Ulex europaeus</i>	34
Chaffinch	80	<i>Sambucus nigra</i>	32
Yellowhammer	91	<i>Salix spp.</i>	22
Blue tit	71	<i>Rubus spp.</i>	17
Dunnock	63	<i>Aperaceae</i>	15
Starling	47	<i>Acer pseudoplatanus</i>	10
Blackcap	47	Air	12
House sparrow	45	<i>Prunus spinosa</i>	9
Great tit	40	<i>Corylus avellana</i>	4
Lesser whitethroat	30	<i>Urtica dioica</i>	3
Garden warbler	26		
Wren	24		
Bullfinch	23		
Willow tit	23		
Song thrush	21		
Woodpigeon	12		
Magpie	10		
Partridge	6		
Goldfinch	4		
Carrion crow	3		
Skylark	3		

Table 11. The number of observations of each bird species (a), data pooled across all sites; and the number of observations in the 15 micro-habitat categories. (n = 1821).

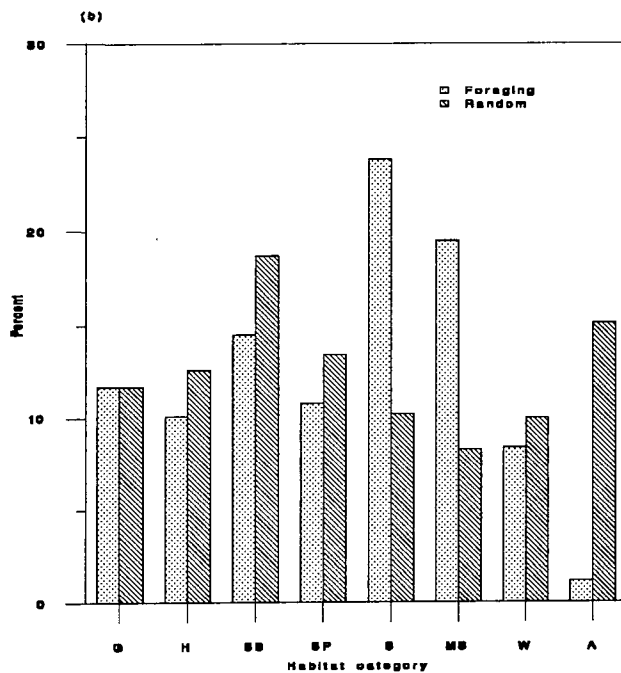
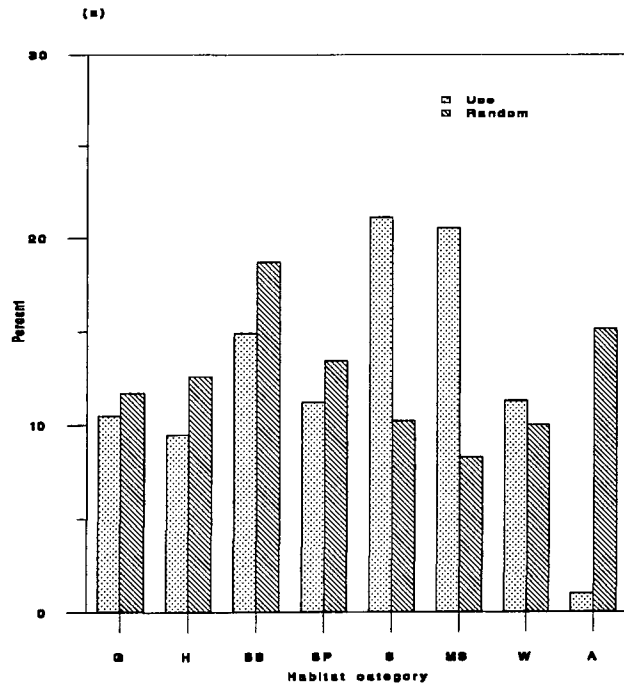

Figure 13. A comparison of the frequency of occurrence of birds in eight habitat categories during all behavioural records (a), and whilst foraging (b), both shown against the occurrence of the categories in a random habitat sample (Random) as a measure of the availability of the habitat categories. Bird species codes are given in table 2. Habitat variables are defined in sect. 3.2. (Data pooled from all sites, foraging records: B; n = 74; D; n = 30; LI; n = 37; WH; n = 79; WW; n = 167. Other behavioural record: B; n = 116; D; n = 63; LI; n = 116; WH; n = 176; WW; n = 279. Random habitat records; n = 411).

method used to define a territory (sect 3.1) inevitably led to the inclusion of some areas of habitat within the territories that were in reality not used by that species.

In summary, the birds at these sites defend territories more frequently in areas of more enclosed habitat. Birds are also recorded more frequently than expected (though not in territorial activities) in grassland, scattered scrub, scrub and mature scrub. They are also recorded foraging more frequently in grassland, scattered scrub, scrub and mature scrub.

4.6.3 Linnets, *Paridae* and Dunnocks

The large variation in density across the three sites of four of the more common species Linnet, Blue tit, Great tit, and Dunnock, has already been highlighted, though as yet no real explanation for this trend has been apparent. The CCA species ordination indicated that the Linnet and Dunnock were strongly associated with the biplots, representing increased cover of gorse and brambles. No such specific association was apparent in the case of the *Paridae*, but during the observations on the site a hypothesis was formed that these species were seen more frequently in the location of the quarry face.

Blue tit and Great tit observations were pooled to see if some explanation of their low density at Sherburn could be explained. The foraging preferences of these two *Paridae* have been extensively studied (Perrins 1977), and are a well documented example of ecological separation (Lack 1971). In the light of these previous studies, the justification for pooling the data for these two species was that the limiting factor in their distribution was thought to be the absence of suitable nesting sites, rather than the provision of a foraging niche. In this respect, the requirements of the two species are similar, as they both require holes of fairly small diameter in which to nest (Perrins 1977).

The use of the quarry face by the Blue tit and Great tit was more frequent than expected (chi-square = 30.604 with Yates' correction, 1 df, $P < 0.001$). Further insight to the use of this habitat by these species is given by looking at the behaviour when sighted in these categories. All 14 sightings were associated with the carrying of food into a cracks in the quarry face, that were assumed to be nesting sites. The lack of mature trees with suitable holes and cracks for nesting, and the use of the quarry as a nest site would account to some extent for the low density of these species at Sherburn, whose quarry face area is approximately one sixth of that at Wingate (see sect. 4.2).

A similar analysis of the Linnet sightings, comparing this species' use of gorse to all other micro-habitats was also significant (chi-square = 14.298 with Yates' correction, 1 df, $P < 0.001$). Further analysis of the Linnet sightings reveals 9 of the observations (50%) were of territorial behaviour, and none were of foraging. Gorse is a favourite nesting site of the Linnet, especially in early spring before deciduous shrubs come into leaf (Newton, 1972), and these results suggest that this species is selecting sites with areas of gorse, in which to establish territories. The low density of this particular habitat at Wingate is suggested as a reason for the absence of the Linnet at this site.

The variation in density of the Dunnock is not so easily explained. There was significant difference in its use of gorse and brambles in comparison to their occurrence in the random habitat samples (chi-square = 10.81, 2 df, $P < 0.01$), but this indicated a negative rather than a positive

correlation to this variable, as there were less sightings in these categories than expected. There are two explanations of these apparently conflicting results. First that the Dunnock is selecting for some other habitat variable associated with gorse and brambles that was not measured. Second the Dunnock being primarily a ground forager (see later results) was not recorded foraging directly on these variables, but beneath them or near them and this fact was not recorded by any of the measured variables. Without further study this cannot be proved and remains as a hypothesis.

4.6.4 The use of the habitat by foraging birds

Over 50% (n = 934) of the behavioural observations were of foraging manoeuvres. A total of 25 species were recorded foraging at the three sites, 50% of the records were of indeterminate sex, 30% were males and 20% were females. In view of the relatively high proportion of unknown sex, the data on foraging are pooled for all sex categories. This is common practice in foraging studies (Grubb & Woodrey 1990). However, when the effect of sex is taken into account, the results illustrate that sex, age and intraspecific social dominance categories, may play an important part in determining behaviour and fitness (Hanowski & Niemi 1990 and Grub & Woodfrey, 1990). This must be borne in mind in any interpretation of pooled data.

4.6.6 The use of the micro-habitat by foraging birds

Birds were recorded foraging in 14 different micro-habitat categories (Tab. 12a). Over 90% of these records were on just 4 genera and one other category; hawthorn; grass; *Epilobium*; ash and "Ground".

The differences in the frequency of use of the micro-habitat in relation to its occurrence in the habitat was tested using chi-square. The result, chi-square = 543.94, 12 df, $P > 0.001$, is highly significant. The presence of 2 expected values of less than 5 is not considered deleterious to the significant result, as it represents less than 20% of the number of values entered, and the chi-square value is well in excess of that required for a significant result at the requisite level of P . Inspection of the expected figures (Tab. 12b) pin-points the association further, revealing that despite its high use *Epilobium*, litter and grass are used only about as frequently as is expected by their occurrence in the habitat. Other frequently occurring groups, brambles, rose, cow-parsley, gorse, elder and nettles are all used less than expected. However, hawthorn, ash, sycamore and willow are all used more frequently than is expected. There are several reasons why hawthorn might be a favoured site for foraging birds, not least being its relative impenetrability to many predators. It is also the first species in the scrub to flower, providing a flush of buds in the early spring (O'Connor 1986), and it has an abundant insect fauna (Pollard Hooper & Moore 1974).

It is interesting that the species that are most frequently used in relation to their occurrence, are all tree species, and are at the two extremes of abundance. Hawthorn is present in 302 or 73.5% of all

(a)

Species or category in which bird recorded		Number of foraging records
<i>Acer pseudoplatanus</i>	Sycamore	8
<i>Crataegus monogyna</i>	Hawthorn	444
<i>Corylus avellana</i>	Hazel	1
<i>Fraxinus excelsior</i>	Ash	43
<i>Salix</i> spp.	Willow	7
<i>Sambucus nigra</i>	Elderberry	1
<i>Ulex europaeus</i>	Orse	3
<i>Rosa</i> spp.	Wild rose	31
<i>Rubus</i> spp.	Brambles	11
<i>Epilobium hirsutum</i>	Rosebay Willow-herb	64
<i>Aperaceae</i> spp.	Cow parsley	13
<i>Urtica</i> spp.	Nettles	3
<i>Gramineae</i> spp.	Grasses	198
Ground		104
Air		3

(b)

Micro-Habitat	Presence-Random Habitat Sample		Foraging Use	
	Observed	Expected	Observed	Expected
Ground (Litter)	222	216	104	110
Hawthorn	302	494	444	252
Willow-herbs	126	126	64	64
Ash	16	39	43	20
Grass	371	377	198	192
Sycamore	3	7	8	4
Willow	3	7	7	3
Elderberry	82	55	1	28
Nettles	48	34	3	17
Brambles	213	148	11	76
Rose	207	158	31	80
Orse	98	66	3	34
Cow-parsley	131	95	13	49

Table 12. Plant species or micro-habitat category (variable (d). sect. 3.3) in which foraging manoeuvres were recorded (a) Latin binomial and common name; and the number of records in each category ($n = 934$). Contingency table (b) for 15 micro-habitat categories and their frequency of occurrence (presence or absence) in the random vegetation samples ($n = 411$); and the use of these micro-habitats by foraging birds.

samples, ash is present in 16 or 3.9% of all samples, and sycamore and willow in just 3 or 0.7% of all samples. The high use of the most common plant species on the site might be expected as these characterise the habitat, which certain bird species are, by the process of evolution, well adapted to exploit. The high use of less common species is less easy to explain and requires further analysis of the species or range of species that are exploiting them.

Seven species of bird were recorded foraging on sycamore, ash and willow; Willow warbler, Whitethroat, Lesser whitethroat Longtailed tit, Blue tit, Great tit and Chaffinch, all are fairly common species on the sites. A comparison was made between the use of these trees by the 7 bird species, and the use of hawthorn by the same 7 bird species. The result (chi-square = 7.589, 5 df), was not significant. This suggests that the less common tree species are exploited at a similar frequency in relation to their occurrence as hawthorn. This further suggests that their relatively high use in comparison to their occurrence in the habitat is the result of exploitation by common birds from the habitat, rather than specialist exploitation of a particular niche by uncommon species.

4.6.7 The foraging activities of five individual bird species

In order to investigate the relationships between individual bird species and their use of the habitat, 5 of the more common bird species, for which a reasonably large number of foraging records had been collected ($n > 30$), were chosen for further analysis. These were Dunnock, Blackbird, Whitethroat, Willow warbler and Linnet.

The five species chosen can be seen in terms of the ordination (Fig. 11) to represent three groups, two of which are pairs. The Blackbird and Dunnock are at the centre of the ordination, suggesting similarity in requirements, and selection for the most common aspects of the sites as measured by the recorded habitat variables.

The Dunnock and Linnet are also relatively close to each other in the ordination, suggesting similar requirements, however their position towards the negative end of axis 1, suggests they are associated with less common features of the sites, in particular more open areas, with less canopy cover. The Whitethroat is separate from the other species, and from Willow warbler, also from the family *Sylviidae*, and is strongly associated with open ground with a well developed field layer.

Further analysis of the foraging data will be used to try and elucidate some of the relationships that exist between the bird species and the habitat variables. Also it is hoped to show some of the differences between species that the ordination has grouped together.

4.6.8 Use of the habitat by individual bird species

A comparison using chi-square, in the frequency with which the species used the habitat for foraging (Fig. 14) was statistically significant (chi-square = 36.675, 16 df, $P < 0.001$) The Blackbird is recorded foraging more frequently in "Grassland" and "Hedges", the Dunnock in "Hedges", the Linnet in "Mature Scrub", the Whitethroat in "Scrub Patches", and the Willow warbler in "Scrub" and "Mature Scrub".

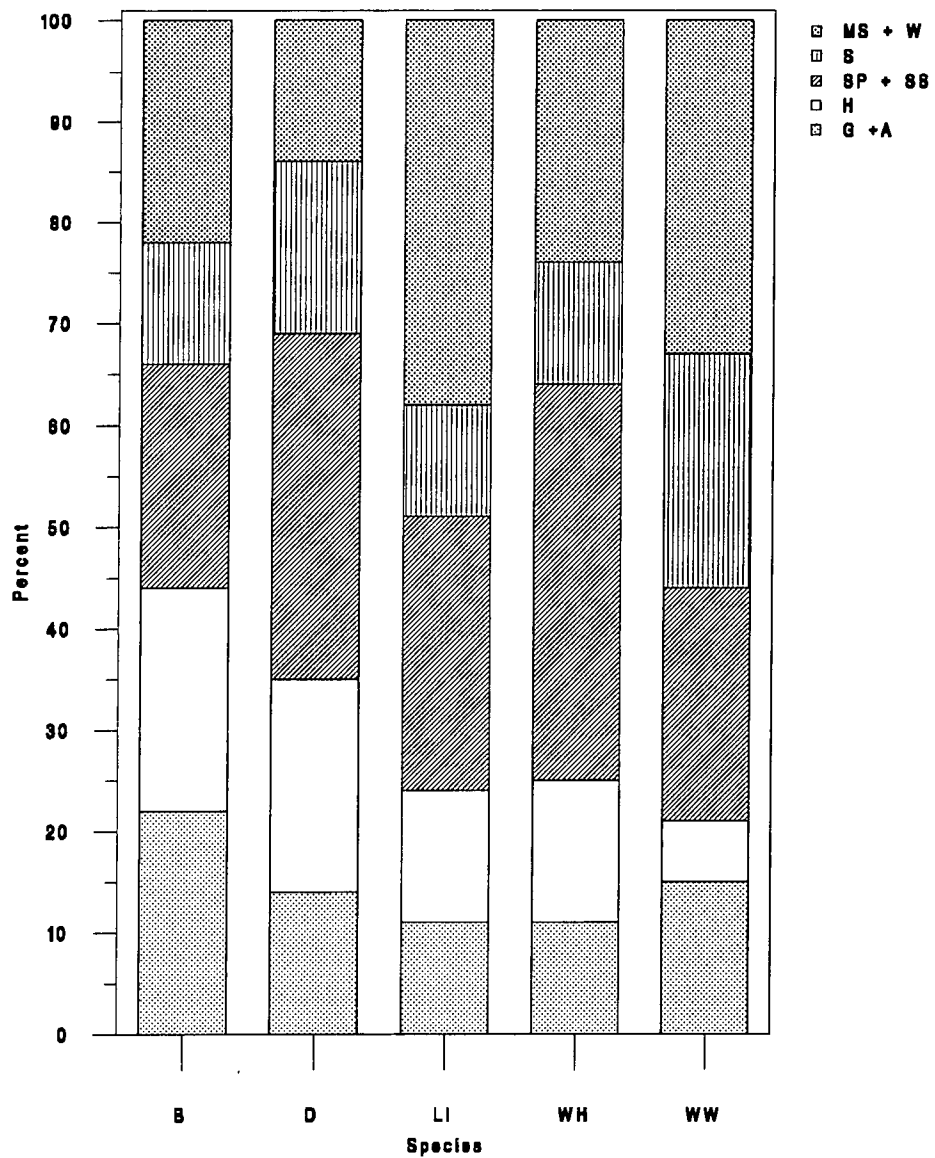

Figure 14. A comparison of the frequency of foraging use of five habitat categories by five common birds of the sites. Grassland and arable fields are combined, (G + A): Scrub patches and scattered scrub are combined, (SP + SS): Mature scrub and woodland are combined, (MS + W): The other two categories are hedges (H), and scrub (S). Bird species codes are defined in table 2. (Data pooled from all sites, B; n = 74: D; n = 30: LI; n = 37: WH; n = 79: WW; n = 167).

4.6.9 Use of the micro-habitat by individual bird species

Within each habitat it appears that each species also has a preference for a particular micro-habitat (Fig. 15a). The Blackbird, Dunnock and Linnet foraging more on the ground; Willow warbler more in "Cm" and "Fe & Others", and Whitethroat more in "Tall" herbaceous growth. The results of the analysis (chi-square = 359.375, 12 df, $P < 0.001$), indicate that these differences are highly significant.

The 5 species also forage in significantly different height classes (Fig. 15b) (chi-square = 348.788, 20 df, $P < 0.001$). The result is still significant (chi-square = 290.001, 12 df, $P < 0.001$) when the "Shr.L & "Field" and "Shr.H" and C.max" are combined to avoid low expected values.

4.6.10 Position and perch in the micro-habitat.

The position of each species within the micro-habitat also demonstrates the differences between species (Fig. 16a). These differences are also reflected in the perch that each species uses (Fig. 16b), and the position of its perch in the micro-habitat. The Blackbird, Dunnock and Linnet are essentially ground foragers, and this is reflected in their position, perch and substrate, being predominantly the ground. There is some variation within this pattern, the Dunnock and Linnet being more flexible in their foraging, spending some time in the vegetation perched on twigs foraging from leaves. The Whitethroat and Willow warbler are found almost entirely in the vegetation, the smaller Willow warbler more frequently in the distal portions of the plant.

The differences between species in foraging substrate and foraging manoeuvre (Fig. 17a & b) are less subtle. The substrate is either predominantly the ground, as in the case of the Blackbird, Dunnock and Linnet; or predominantly leaves as, in the case of the Whitethroat and the Willow warbler. The Willow warbler was also seen making aerial sallies to catch prey in flight.

The majority of foraging manoeuvres were classified as gleaning actions (Fig. 17b), however, the ground foragers did show some variation in their foraging manoeuvres, which further separated the species. The Blackbird in particular was seen to probe for prey items, such as when foraging for earthworms (*Lumbricus spp.*). This manoeuvre was also used to a lesser extent by Linnet and Dunnock. The prey items were not discernible, but were smaller than those attacked by Blackbird. The Dunnock was also seen foraging under leaf litter, recorded as a "Peck" as the substrate (the leaf litter) was being manipulated.

The between species differences in foraging Position, Perch, Manoeuvre and Substrate were analysed using chi-square. As with some of the previous analysis the appropriate precautions were observed to overcome the presence of low expected values.

The final categories used in the chi-square analysis together with the original categories are shown in (appendix 18 & 19). The chi-square values; Position = 358.063, 12 df, $P < 0.001$; Perch = 313.209, 4 df, $P < 0.001$; Substrate = 308.505, 4 df, $P < 0.001$; Manoeuvre = 51.769, 4 df, $P < 0.001$; are all highly significant.

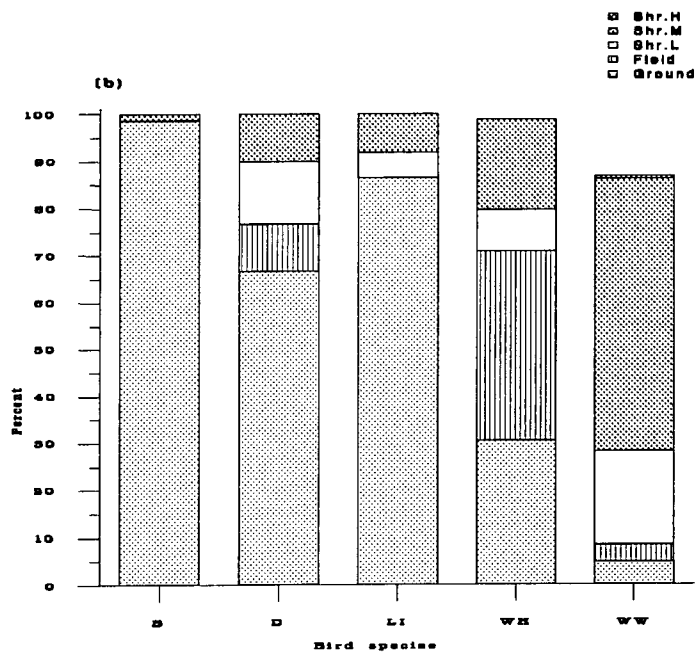
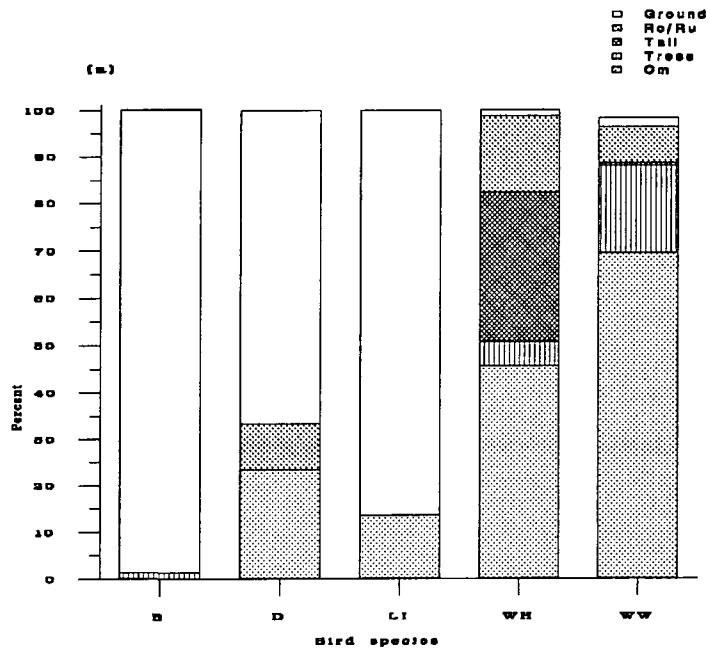

Figure 15. A comparison of the relative frequency of use of the micro-habitat (a), and the relative frequency of use of different height classes (b), by 5 common birds, whilst foraging. Bird species codes are given in table 2. Habitat variables are defined in sect. 3.2. (Data pooled from all sites, B; n = 74; D; n = 30; LI; n = 37; WH; n = 79; WW; n = 167).

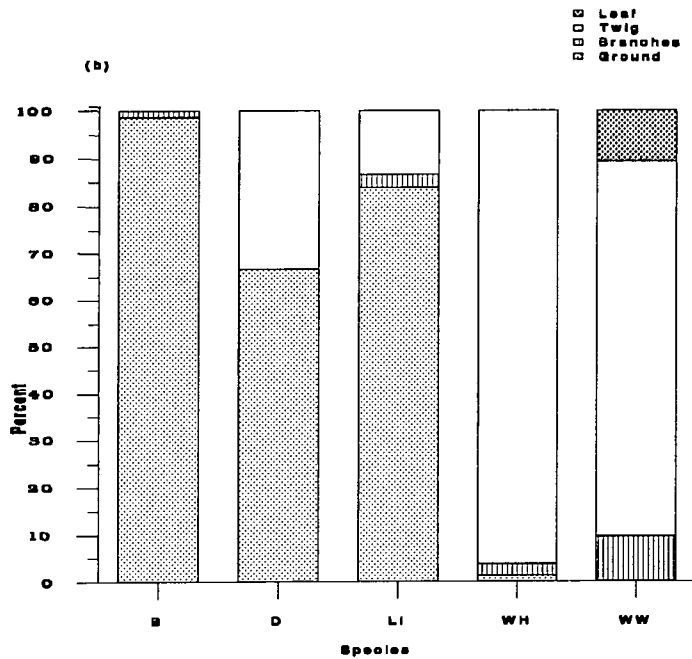
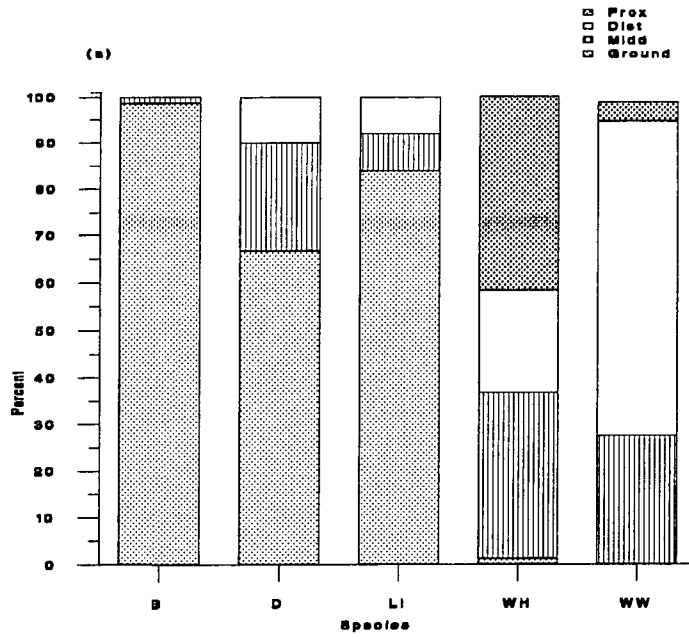

Figure 16. A comparison of the relative frequency of occurrence of 5 common species in 4 position categories (a), and on 4 perch sites (b), whilst foraging. Bird species codes are given in table 2. Habitat variables are defined in sect. 3.2, behavioural variables in sect. 3.3. (Data pooled from all sites, B; n = 74; D; n = 30; LI; n = 37; WH; n = 79; WW; n = 167).

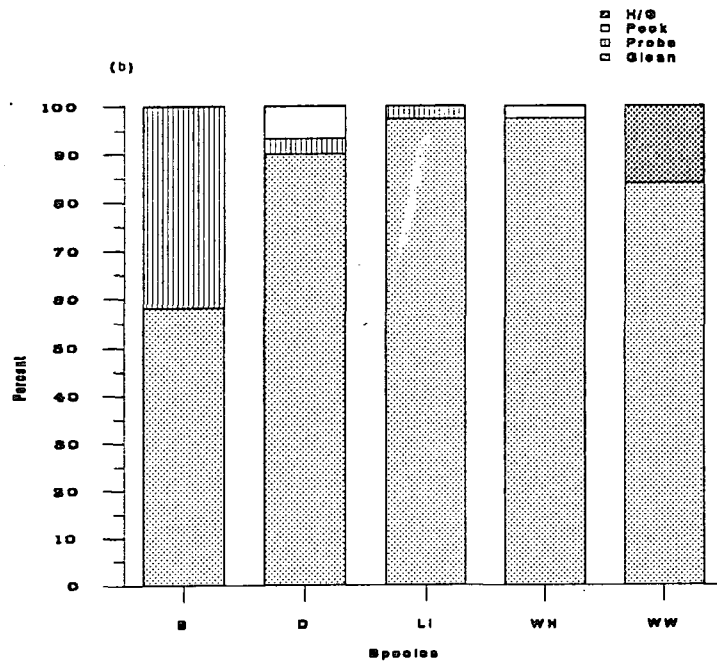
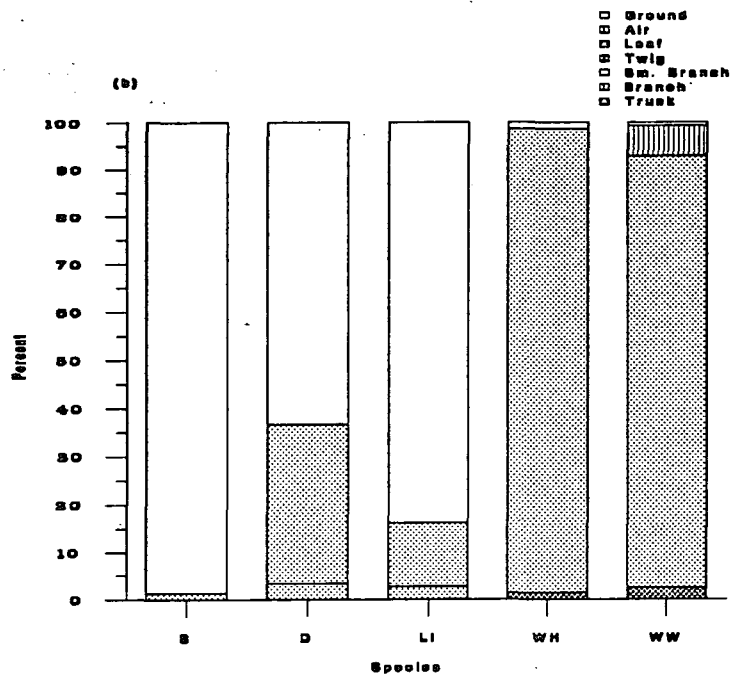

Figure 17. A comparison of the relative frequency of use of different of different substrate categories (a), and the foraging manoeuvres (b), used at the substrate by 5 common birds. Bird species variables are given in table 2. Foraging manoeuvres and their codes are described in sect. 3.3. (Data pooled from all sites, B; n = 74; D; n = 30; LI; n = 37; WH; n = 79; WW; n = 167).

4.6.11 Individual species foraging summary

The results of the foraging analysis serve to highlight further the different aspects of the habitat that each species is selecting for. Despite their similar position in the ordination, and that they are both predominantly ground foragers, the Dunnock and Blackbird are in fact selecting for different variables at each level of analysis. They show differences in habitat, micro-habitat, height, position, substrate and foraging manoeuvre (Figs. 14-17). This illustrates two points of particular interest to this study. First that the scale of observation chosen for the ordination is insufficient to separate fully the habitat parameters important to individual species. That is not to say that a more precise scale should have been used, as there is a danger of being swamped by a multitude of variables, and losing sight of the overall environmental gradients that cover all sites. Second, that if we are to understand fully what determines the distribution and abundance of the bird species on the sites, both the structural, and specific, environmental variables are needed.

More specifically, these results confirm the associations of Whitethroat with a well developed herb and field layer, inferred by the species ordination (Fig. 11). They also add a further dimension to the relationship between Blackbird and Willow warbler. The vertical dimension of the foraging niche effectively separates these species, despite their similarities in macro-habitat requirements.

5.0 DISCUSSION

There are theoretical models (Fretwell & Lucas 1970) and specific studies (O'Connor & Fuller 1985) that suggest that birds may occupy sub-optimal territories, across a wider range of habitats, when population densities are high, compared to when they are low. In order to make comparisons between these results and other sites, and also to make assessments of the choice of habitats by particular species, it is desirable to ascertain how representative the results of this study are of a typical year on the sites. The BTO's Common Bird Census (Marchant, Musty & Carter 1991) was used to assess to what extent the population levels of the birds breeding in and around the sites were typical of levels that might be expected in an average year. The previous winter (1991-92) had been mild and was assumed not to have caused exceptional overwinter mortality of resident species. The majority of species recorded on the sites showed population levels in 1991, and trends for the previous five years that showed no significant change. Blackbird, Willow warbler, Long-tail tit, Blue tit and Great tit all showed significant decrease on woodland plots in the 1990 breeding season, whilst the five-year trend for these species was one of no real change. The conclusion is that the results are likely to be broadly typical of recent years, whilst the possibility of a recent decline in the four mentioned species is noted.

5.1 The bird community

The varying stages of hawthorn scrub at the three sites support a breeding bird community that is striking both in terms of species diversity and especially the total number of pairs. The densities at all sites exceeds that reported in all comparable scrub habitats (Williamson 1967 & 1975; Morgan 1975). The only comparable figures come from specialised scrub habitats managed for birds, such as the coppiced willow at Leighton Moss R.S.P.B. reserve, where a density of 14.90 territories per hectare was recorded (Wilson 1978). Even with regard to the care that must be exercised in the comparison of bird densities between sites of different areas, and between different years (Fuller & Moreton 1987), these results demonstrate the value of hawthorn scrub as a bird habitat. This is in direct contrast to the threat that hawthorn is seen to pose to limestone grassland (Doody, 1980).

5.2 Habitat features important to birds

The results of the territory mapping, the ordination (Fig. 11), and the chi-square analysis of macro-habitat (sect. 4.6.2) all suggest that the birds breeding on the sites are positively selecting for the more enclosed habitats offered by hedges and scrub formations.

In addition, three species Linnet, Blue tit and Great tit demonstrated selection for quite specific aspects of the habitat, believed to correspond to their nesting requirements.

The results of the constrained ordination indicate that considered separately the structural variables explain more of the community variation (fraction extracted by CCA axes 1 & 2 = 15.1%) than the species variables (fraction extracted by CCA axes 1 & 2 = 8.5%). Additionally 59% of the bird species entered into the final ordination show a positive correlation with axis 1, itself highly correlated to the structural variables corresponding to a high foliage volume in the high shrub layer and a tall canopy. This agrees with the model of MacArthur & MacArthur (1961) whereby an increase in the Foliage Height Diversity results in an increase in the species diversity of the community.

Different relationships between the birds and the vegetation were evident when the behaviour of individual species of birds on the sites were examined, with 89% of the observations being gathered on 14 genera of plants, 60% of these on ash and hawthorn. These results do not conflict with those obtained in the multivariate analysis, the species variables for hawthorn and ash are highly correlated to the structural variables of the first CCA axis. They do emphasise that the scale of the observation will reveal different patterns in avian habitat selection, and that much of the subtle community variations may be lost if the study is conducted on the coarse scale of habitat physiognomy.

5.3 A question of scale

The data used in this study was conducted on two very different scales. The census observations, the vegetation sampling, and the subsequent multivariate analysis were all based on the

scale of the bird territory, or the 0.02 ha sample circle. The behavioural observations, in contrast, were based on the smaller scale of a specific bird or plant species. In a summary of this analysis (Tab. 11) 77% of the observations were in just 4 genera. This suggests that if the scale of examination is fine enough more subtle responses to vegetation are likely to be detected.

Since the early suggestions of Lack (1933), and the more empirical demonstrations of MacArthur *et al.* (1961) that birds may select the habitat that they occupy on the basis of the physiognomy of the habitat, most studies of bird-habitat relationships have emphasised the structural features (Wiens 1969; Bibby, Bain & Burges 1989; Henderson & Bayes 1989). In contrast a limited number of studies have reported specific associations between bird and plant species (Peck 1989; Bibby, Aston & Bellamy 1989; Holmes & Robinson 1981; Fuller & Henderson 1992).

The patterns of distribution of birds across the sites are a consequence of decisions made by individual birds in selecting a place in which to forage or establish a breeding territory. A great many factors influence these decisions, and differences in the effects of these factors produce the variation in habitat occupancy, both within and between species (Wiens 1989).

At the coarsest scale the birds can be seen to be responding to the succession from grassland through to the climax ash woodland. This brings about a succession in the community from birds of open grassland such as the Skylark; through those of hedges and woodland edge such as the Yellowhammer and Linnet; to the woodland species such as the Blackcap and Chaffinch (Fuller, 1982). These patterns are broadly reflected in the ordination of the samples and species from the three sites (Figs. 11 & 12). Yet of the patterns in distribution in individual species that emerge between the three sites (Tab. 6), none can be explained simply in terms of the succession through the sites as represented from the more open areas of Wingate through Pittington, to the more dense habitats of Sherburn. This is because at a finer scale there are subtle variations in habitat within sites, which the birds are responding to. For example Wingate, despite being characterised as an open site, also has concentrated pockets of woodland (Fig. 1) which may account for the relatively high density of some "woodland" species on the most "open" site.

5.4 What makes a "good" quarry?

The results of this study shed some light on the particular preferences of the bird species on these sites in relation to their territorial and foraging requirements. The preference of the majority of species on the sites, for scrub in which to forage and nest, may be seen to conflict with the management requirements of the sites for the magnesian limestone grasslands, but this need not necessarily be the case.

The particular ecological significance of the magnesian limestone grasslands of Durham county were discussed in the introduction. The limited extent of this resource and its fragility in the face of increased quarrying and agricultural intensification justify the prominence that these grasslands are given in the management of these sites.

However, scrub vegetation has an intrinsic value because of its diversity of species and structure during seral changes, and its special importance of these features for insects and birds (Ward 1990). Mosaic arrangements of scrub give the most promise of enhancing species diversity, and the arrangement of these mosaics outside of the best areas of grassland is the most obvious compromise.

5.4.1 A "good" quarry for birds

A "good" quarry for birds would be one that enhanced the overall diversity of the bird community through increases in species richness and relative abundance.

The present study has shown that the increase in the diversity of the vertical component of the vegetation, associated with increasing scrub, can lead to an increase in the bird species diversity of the sites. One obvious interpretation of this is that the increased vertical component offers a greater variety of potential niches, and allows addition of species to the bird community. This is confirmed to an extent by a brief look at 5 of the common species on the site and demonstrating that they do differ significantly in their choice of micro-habitat, whereas the macro-habitat they occupy is similar.

The results of the behavioural observations reveal that different components of the habitat are also important for other species that do not breed in the scrub, and that species that defend areas of scrub in which to nest, may utilise other aspects of the habitat whilst foraging. This is particularly well demonstrated in the case of the Linnet and Paridae but it is suggested that if a sufficiently fine scale of observation were used, similar segregations of the habitat components by other species may be found, and it is at this scale of observation that the more subtle variations in the community between sites might be explained.

5.4.2 Grassland and scrub balance

Pittington quarry had the greatest number of bird species recorded on the sites, both overall, and those that were only recorded foraging on the sites; it also had the highest territory density, and only one breeding species less than Sherburn, the site with most breeding species. Pittington Hill also supports one of the most extensive areas of Magnesian Limestone grassland in County Durham, and was notified as a Site of Special Scientific Interest in 1987, in recognition of its flora and invertebrate fauna (NCC 1987).

Pittington is characterised by the predominance of scrub patches (Tab. 7), and it appears that the mosaic of habitats that this creates is favourable to both breeding and foraging birds. The grazing of the site by horses prevents further encroachment of the scrub, and the hoof-prints provide regeneration niches for a wide variety of calcicoles plants. These in turn provide the food plants for the diverse invertebrate fauna recorded at this site (NCC 1987). More detailed analysis of the diets of birds and their specific nesting requirements would be valuable in the judgement of the management of these sites. It

would also be interesting to see if the correlates of floral and invertebrate diversity were in some way related to the bird species diversity.

These details refute the often held belief that "scrub is the botanical counterpart of vermin" (Williamson 1967), and demonstrate that a scrub encroached grassland can be successfully managed for birds, invertebrates and flora. This management appears to be to allow the scrub to develop in specific patches to add biological and structural diversity to the vegetation, without allowing the complete succession to a woodland climax to occur. To encourage the woodland species onto the site, the canopy must be allowed to develop, and this has been achieved at Pittington in discrete corners of the site, on less interesting neutral grasslands and along boundaries or adjacent sites.

5.5 A snapshot in time

The results presented in this study are based on a four month period in a single year and as such can only represent a snap-shot of the bird communities of these sites. This must be taken into account when assessing the ornithological importance of these and similar sites. Beven (1964) made a study of the extent to which the various habitat patches in a chalk scrub were used by foraging birds over a four year period (1959-1963). The findings of his study were similar in that three types of feeding site were most important; the shrubs, the herb layer and the ground. Scrub was the most frequently used feeding site throughout the year, but it was in the autumn that it became the focal point of bird activity. The rich variety of fruits provided by many of the shrub species is highly attractive to many bird species, especially thrushes (Fuller, 1982). This aspect of the sites is not addressed at all by this study. If the winter use of these sites were similar to those reported elsewhere it would add another important dimension to the ornithological quality of the sites.

5.6 Conclusion

A single census in a single year even when associated with recorded habitat characteristics may pose more questions than it answers. Statistical correlation only shows that a particular pattern holds in the particular data with a given range of probability (Wiens 1981) and while these patterns may suggest interesting linkages between birds and their choice of habitat, to base management policies upon them may be premature. Even when viewed over time, the response of bird communities to changes in their habitat are clouded by territorial behaviour, philopatry, time lags and stochastic environmental events.

This study has shown that three disused quarry sites in County Durham offer potential breeding and feeding sites for a wide variety of resident and migrant bird species. These results indicate that there is a potentially large benefit to bird conservation to be gained in the assessment and monitoring of these sites particularly in view of the large number (111) of similar disused quarry sites in the county (Evans 1980) and the potential that they have as habitat for some of the more common farmland species, such as

the Yellowhammer and Song thrush, whose populations are thought to be most at risk from agricultural intensification (Mead, 1992).

Limestone grassland is not a static habitat, but an early stage in an inevitable succession to a woodland climax. To conserve the interest of the magnesian limestone grassland requires management input to direct and control this succession. It would appear from this study that the creation of a scrub-grassland mosaic, interspersed with taller trees using techniques such as selective felling and grazing, may benefit the farmland bird community, whilst still and enhancing the existing botanical and invertebrate interest.

6.0 REFERENCES

- Anderson, S.H. (1981). Correlating habitat variables and birds. *Estimating Numbers of Terrestrial Birds* (eds. J. Ralph & J.M. Scott), pp. 538-542, Studies in Avian Biology No. 6, Cooper Ornithological Society.
- Andrews, J. & Kinsman, D. (1990). *Gravel Pit Restoration for Wildlife: a Practical Manual*. RSPB, The Lodge, Sandy, Bedfordshire.
- Bates, J.W. (1992). Influence of chemical and physical factors on *Quercus* and *Fraxinus* epiphytes at Loch Sunart, western Scotland: a multivariate analysis. *Journal of Ecology*, **80**, 163-179.
- Berger, W.H. & Parker, F.L. (1970). Diversity of planktonic Foraminifera in deep sea sediments. *Science*, **168**, 1345-1347.
- Beven, G. (1964). The feeding sites of birds in grassland with thick scrub. *London Naturalist*, **43**, 86-109.
- Bibby, C.J., Aston, N. & Bellamy, P.E. (1989). Effects of broadleaved trees on birds of upland conifer plantations in north Wales. *Biological Conservation*, **49**, 17-29.
- Bibby, C.J., Burges, N.D. & Hill, D.A. (1992). *Bird Census Techniques*. Harcourt Brace Jovanovich, London.
- Doody, J.P. (1980). Grassland. *The Magnesian Limestone of Durham County* (ed. T.C. Dunn), pp. 44-50, Durham County Conservation Trust.
- Durham County Council (1979). Report of survey. *The Magnesian Limestone Escarpment Plan*. Durham County Council.
- Evans, A. & Wilson, J. (1992). Farming for birds. *BTO News*, **178**, 1.
- Evans, M.E. (1980). A list of disused quarries on the Magnesian Limestone in County Durham. *The Magnesian Limestone of Durham County* (ed. T.C. Dunn), pp. 77, Durham County Conservation Trust.
- Fretwell, S.D. & Lucas, H.L. (1970). On territorial behaviour and other factors influencing habitat distribution in birds. *Acta Biotheoretica*, **19**, 16-36.
- Fuller, R.J. (1982). *Bird Habitats in Britain*. T & A D Poyser Ltd, England.
- Fuller, R.J. & Moreton, B.D. (1987). Breeding bird populations of Kentish sweet chestnut (*Castanea Sativa*) coppice in relation to age and structure of the coppice. *Journal of Applied Ecology*, **24**, 13-27.
- Fuller, R.J. & Henderson, A.C.B. (1992). Distribution of breeding songbirds in Bradfield woods, Suffolk, in relation to vegetation and coppice management. *Bird Study*, **39**, 73-88.
- Grubb, T.C. Jr. & Woodrey, M.S. (1990). Sex, age, intraspecific dominance status, and the use of food by birds wintering in temperate-deciduous and cold coniferous woodlands: a review. *Avian Foraging: Theory, Methodology, and Applications*, (eds. M.L. Morrison, C.J. Ralph, J.R. Verner & J.R. Jehl, Jr.), pp 270-279. Studies in Avian Biology No. 13, Cooper Ornithological Society.

- Gauch, H.G. Whittaker, R.H., & Wentworth, T.R. (1977). A comparative study of reciprocal averaging and other ordination techniques. *Journal of Ecology*, **65**, 157-174.
- Gauch, H.G. (1982). *Multivariate Analysis In Community Ecology*. Cambridge University Press, Cambridge, England.
- Henderson, A. & Bayes, K (1989). Nightingales and coppice woodland. *Conservation Advice*, RSPB Conservation Management Advisory Service, Sandy, Bedfordshire.
- Hejl, S.J., Verner, & Bell, G.W. (1990). Sequential versus initial observations in studies of avian foraging. *Avian Foraging: Theory, Methodology, and Applications*, (eds. M.L. Morrison, C.J. Ralph, J.R. Verner & J.R. Jehl, Jr.), pp 166-173. Studies in Avian Biology No. 13, Cooper Ornithological Society.
- Holmes, R.T. & Robinson, S.K. (1981). Tree species preferences of foraging insectivorous birds in a northern hardwoods forest. *Oecologia*, **48**, 31-35.
- Humphries, R.N. (1980). The development of wildlife interest in limestone quarries. *Reclamation Review*, **3**, 197-207.
- James, F.C. (1971). Ordinations of habitat relationships among breeding birds. *Wilson Bulletin*, **83**, 215-236.
- James, C. & Rathbun, S. (1981). Rarefaction, relative abundance, and diversity of avian communities. *Auk*, **98**, 785-800.
- Johnson, D.H. (1981). The use and misuse of statistics in wildlife habitat studies. *The Use of Multivariate Statistics in Studies of Wildlife Habitat* (Ed. by D.E. Capen), pp. 11-19. U.S.D.A. General Technical Report RM-87, Fort Collins.
- Krebs, J.R. (1971). Territory and breeding density in the great tit (*Parus major* L.). *Ecology*, **52**, 1-22.
- Lack, D. (1933). Habitat selection in birds, with special reference to the effects of afforestation on the Breckland avifauna. *Journal of Animal Ecology*, **2**, 239-262.
- Lack, D. (1971). *Ecological Isolation In Birds*. Blackwell Scientific Publications, Oxford.
- Landres, P.B. & MacMahon, J.A. (1983). Community organisation of arboreal birds in some oak woodlands of western North America. *Ecological Monographs*, **53**, pp. 183-208.
- MacArthur, R.H. (1972). *Geographical Ecology*. Harper and Row, New York.
- MacArthur, R.H. & MacArthur, J.W. (1961). On bird species diversity. *Ecology*, **42**, 594-598.
- MacArthur, R.H., Recher, H. & Cody, M.L. (1966). On the relationship between habitat selection and species diversity. *American Naturalist*, **100**, 319-322.
- Magurran, A.E. (1988). *Ecological Diversity and Its Measurement*. Chapman and Hall, London.
- Marchant, J, Musty, L. & Carter, S. (1991). Common Birds Census: 1989-1990 index report. *BTO News*, **177**, 11-14.
- May, R.M. (1975). Patterns of species abundance and diversity. *Ecology and Evolution of Communities*, (eds. M.L. Cody & J.M. Diamond), pp. 81-120. Belknap, Cambridge, Massachusetts.
- Mead, C. (1992). Bye bye blackbird? *BTO News*, **181**, 1.
- Meents, J.K., Rice, J. Anderson, B.W. & Ohmart, R.D. (1983). Nonlinear relationships between birds and vegetation. *Ecology*, **64**, 1022-1027.
- Morgan, R. (1978). Breeding bird communities on chalk downland in Wiltshire. *Bird Study*, **22**, 71-83.

- Morgan, R.A. & O'Connor, R.J. (1980).** Farmland habitat and yellowhammer distribution in Britain. *Bird Study*, 27, 155-162.
- Newtom, I. (1972).** *Finches*. Collins, London.
- NCC. (1985).** *Sherburn Hill: Site of Special Scientific Interest (SSSI) notification*. Unpublished circular, Nature Conservancy Council for England, North-East Region, Newcastle.
- NCC. (1987).** *Pittington Hill: Site of Special Scientific Interest (SSSI) notification*. Unpublished circular, Nature Conservancy Council for England, North-East Region, Newcastle.
- O'Connor, R.J. (1981).** Habitat correlates of bird distribution British census plots. *Estimating Numbers of Terrestrial Birds* (eds. J. Ralph & J.M. Scott), pp. 533-537. Studies in Avian Biology No. 6, Cooper Ornithological Society.
- O'Connor, R.J. & Fuller, R.J. (1985).** Bird population responses to habitat. *Bird Census and Atlas Studies Proceedings VIII International Conference on Bird Census and Atlas Work*, (eds K. Taylor, R.J. Fuller & P.C. Lack), pp. 197-211. British Trust for Ornithology, Tring.
- O'Connor, R.J. & Shrub, M. (1986).** *Farming and Birds*. Cambridge University Press, Cambridge.
- Oelke, H (1981).** Limitations of the mapping method. *Estimating Numbers of Terrestrial Birds*, (eds. J. Ralph & J.M. Scott), pp. 114-118, Studies in Avian Biology No. 6, Cooper Ornithological Society.
- Opdam, P., Rijdsdijk, G. & Hustings, F. (1985).** Bird communities in small woods in agricultural landscape: effects of area and isolation. *Biological Conservation*, 34, 333-352.
- Peck, K.M. (1989).** Tree species preferences shown by foraging birds in forest plantations in Northern England. *Biological Conservation*, 48, 41-57.
- Perrins, C. (1979).** *British Tits*. Collins, London.
- Pollard, E., Hooper, M.D. & Moore, N.W. (1974).** *Hedges*. Collins, London.
- Raphael, M.G. & Maurer, B.A. (1990).** Biological considerations for study design. *Avian Foraging: Theory, Methodology, and Applications*, (eds. M.L. Morrison, C.J. Ralph, J.R. Verner & J.R. Jehl, Jr.), pp 123-125. Studies in Avian Biology No. 13, Cooper Ornithological Society.
- Remsen, J.V. Jr. & Robinson, S.K. (1990).** A classification scheme for foraging behaviour birds in terrestrial habitats. *Avian Foraging: Theory, Methodology, and Applications*, (eds. M.L. Morrison, C.J. Ralph, J.R. Verner & J.R. Jehl, Jr.), pp. 144-160, Studies in Avian Biology No. 13, Cooper Ornithological Society.
- Richardson, J.A., Davis, B.N.K. & Evans, M.E. (1980).** Disused quarries. *The Magnesian Limestone of Durham County* (ed. T.C. Dunn), pp. 61, Durham County Conservation Trust.
- Shimwell, D.W. (1968).** *The Phytosociology of Calcareous grasslands in the British Isles*. Ph.D. thesis, University of Durham.
- Simms, E. (1985).** *British Warblers*. Collins, London.
- Snedecor, G.W. & Cochran, W.G. (1937).** *Statistical Methods*. Iowa State University Press, Ames, Iowa, U.S.A.
- Spencer, V.A. (1976).** *Problems in the Conservation of an Ecological Resource: The Magnesian Limestone Flora of County Durham*. Unpublished M.Sc. thesis, University College, London.

- Ter Braak, C.J.F. (1986).** Canonical correspondence analysis: a new eigenvector technique for multivariate direct gradient analysis. *Ecology*, **67**(5), 1167-1179.
- Ter Braak, C.J.F. (1988).** *CANOCO - a FORTRAN program for canonical community ordination by [partial] [detrended] [canonical] correspondence analysis, principal components analysis and redundancy analysis (version 2.1)*. Technical report: LWA-88-02, Agricultural Mathematics Group, Wageningen, The Netherlands.
- Ter Braak, C.J.F. & Prentice, C.I. (1988).** A theory of gradient analysis. *Advances in Ecological Research*, **18**, 271-317.
- Ward, L.K. (1990).** Management of grassland - scrub mosaics. *Calcareous Grasslands Ecology and Management*, (eds. S.H. Hillier, D.W.H. Walton & D.A. Wells), pp. 134-139, Proceedings of a joint British Ecological Society/Nature Conservancy Council symposium, Bluntisham Books, Huntingdon.
- Whitmore, R.C. (1977).** Habitat partitioning in a community of passerine birds. *The Wilson Bulletin*, **89**, 253-265.
- Wiens, J.A. (1969).** An approach to the study of ecological relationships among grassland birds. *Ornithological Monographs*, **8**, 1-93.
- Wiens, J.A. (1989).** *The Ecology of Bird Communities, Volume 2: Processes and Variations*. Cambridge University Press.
- Williamson, K. (1967).** Some aspects of the scientific interest and management of scrub on Nature Reserves. *The Biotic Effects of Public Pressures on the Environment*. 3rd Sci. Symposium, Monks Wood Experimental Station. NCC/NERC.
- Williamson, K. (1975).** The breeding bird community of chalk grassland scrub in the Chiltern Hills. *Bird Study*, **22**, 59-70.
- Wilson, J. (1970).** The breeding bird community of willow scrub at Leighton Moss, Lancashire. *Bird Study*, **25**, 239-244.



APPENDIX

VARIABLES	CM	FE	OTH	TOT	CMA	CPE	SHRH	SHRM	SHRL	HERB
CM	1.0000									
FE	0.0401	1.0000								
OTH	0.0372	0.1187 *	1.0000							
TOT	0.8703 **	0.4828 **	0.2876 **	1.0000						
CMA	0.4755 **	0.6162 **	0.3035 **	0.7261 **	1.0000					
CPE	0.8318 **	0.4304 **	0.2538 **	0.9383 **	0.6909 **	1.0000				
SHRH	0.4720 **	0.4934 **	0.2707 **	0.6643 **	0.6687 **	0.6100 **	1.0000			
SHRM	0.7840 **	0.3800 **	0.2280 **	0.8711 **	0.6217 **	0.8447 **	0.4921 **	1.0000		
SHRL	0.5834 **	0.2549 **	0.1742 **	0.6374 **	0.4486 **	0.7457 **	0.1478 *	0.6425 **	1.0000	
HERB	0.0030	-0.0605	0.0078	-0.0215	0.1271 *	-0.0578	0.0585	-0.0202	-0.1155	1.0000
FIELD	-0.2926 **	-0.1440 *	-0.1050	-0.3302 **	-0.1957 **	-0.3760 **	-0.1852 **	-0.3228 **	-0.3675 **	0.1558 **
LITTER	0.5176 **	0.2262 **	0.2273 **	0.5805 **	0.3526 **	0.6565 **	0.3554 **	0.5797 **	0.6110 **	-0.1300 *
BARE	-0.1854 **	-0.0429	-0.0567	-0.1866 **	-0.1045	-0.1905 **	-0.1056	-0.1959 **	-0.1646 **	-0.0949
OPEN	-0.6070 **	-0.3300 **	-0.2002 **	-0.6945 **	-0.5039 **	-0.7763 **	-0.2807 **	-0.7169 **	-0.8332 **	0.0722
DENSE	0.1410 *	0.0090	0.0769	0.1389 *	0.1409 *	0.2563 **	-0.0308	0.1772 **	0.4770 **	0.2956 **
HOLLOW	0.5669 **	0.3536 **	0.1886 **	0.6683 **	0.4963 **	0.6465 **	0.3761 **	0.6776 **	0.4980 **	-0.0306
GR	-0.5448 **	-0.2884 **	-0.2163 **	-0.6276 **	-0.5496 **	-0.6634 **	-0.4611 **	-0.5822 **	-0.5500 **	-0.2822 **
UE	-0.0275	-0.0585	-0.0660	-0.0617	-0.0516	0.1837 **	-0.1213 *	-0.0396	0.3454 **	-0.0979
TALL	0.0093	-0.0280	0.0850	0.0135	0.1713 **	-0.0059	0.0629	0.0259	-0.0150	0.6107 **
RO_RU	0.0460	0.0840	0.0841	0.0919	0.0714	0.1215 *	-0.0627	0.1222 *	0.3392 **	0.0311
ECT	-0.2804 **	-0.1181 *	-0.1059	-0.3090 **	-0.3538 **	-0.3318 **	-0.1312 *	-0.2863 **	-0.3707 **	-0.0940

