



Durham E-Theses

Polyfluorinated compounds via free-radical reactions of alcohols and diols

Farren, Christopher

How to cite:

Farren, Christopher (1998) *Polyfluorinated compounds via free-radical reactions of alcohols and diols*, Durham theses, Durham University. Available at Durham E-Theses Online:
<http://etheses.dur.ac.uk/4791/>

Use policy

The full-text may be used and/or reproduced, and given to third parties in any format or medium, without prior permission or charge, for personal research or study, educational, or not-for-profit purposes provided that:

- a full bibliographic reference is made to the original source
- a [link](#) is made to the metadata record in Durham E-Theses
- the full-text is not changed in any way

The full-text must not be sold in any format or medium without the formal permission of the copyright holders.

Please consult the [full Durham E-Theses policy](#) for further details.

UNIVERSITY OF DURHAM

A THESIS
entitled

**POLYFLUORINATED COMPOUNDS VIA FREE-RADICAL
REACTIONS OF ALCOHOLS AND DIOLS.**

The copyright of this thesis rests
with the author. No quotation
from it should be published
without the written consent of the
author and information derived
from it should be acknowledged.

submitted by

CHRISTOPHER FARREN B.Sc. (Hons) Dunelm
(Hatfield College)

A candidate for the degree of Doctor of Philosophy

Department of Chemistry

1998

1 2 MAR 1999

*Cupid and my Lady played
At cards for kisses; but Cupid paid.
He stakes his quiver, bow and arrows,
His mother's doves and team of sparrows,
Loses them too; then down he throws
The coral of his lip, the rose
Growing on his cheek (but none knows how),
With these the crystal of his brow,
And then the dimple of his chin:
All these did my fair Lady win.
At last he set her both his eyes;
She won, and Cupid blind did rise.
O love! Has she done this to thee?
What shall, alas, become of me?*

J. Lyly.

Acknowledgements.

I would like to thank Professor R. D. Chambers for his invaluable help and support throughout this work, and Dr. G. Sandford for his many insights and comedy impressions.

A mention must go to all members of the fluorine lab, both past and present, for some memorable times, namely Alex, Andrew, Anwar, Bob, Chris, Christelle, Corinne, Julian, John, Keith, Mandy, Matthew, Phil, Steven and Tony. Also worth mentioning are those non-chemists who have been close to me over the last three years, including Astronaut, Bar Steward, Ginger, Jaffa, Labcoat, Little Emma, Locket, Parvy, Scary Keith, Small Keith, Stick Insect, Stopout, Toxic Avenger, Vonkie and Wino (You know who you are!).

This thesis could not have been completed without the aid of the highly professional technical staff in the department, including Dr. Alan Kenwright, Dr. Ray Matthews, Mrs. Julia Say and Mr. Ian McKeag (NMR); Dr. Mike Jones and Miss. Lara Turner (Mass Spectroscopy); Mrs. Jaraka Dorstal (Elemental Analysis); Mr. Lenny Lauchlin (Chromatography); Mr. Ray Hart and Mr. Gordon Haswell (Glass Blowing); Dr. Andre Batsanov (X-Ray crystallography); Mr. Dave Hunter (High Pressure Laboratory); Mr. Jimmy Lincoln and Mr. Joe Peel (Stores); Mrs. Hazel Barker and Mrs. Jean Parnaby (Laboratory Hygeine Staff); Mrs Irene Harries, Mrs. Carole Hubrey and Mrs. Anne Carrahar (Secretarial Staff) and many others.

Last, but not least, I would like to thank my family and especially Nicola, for looking after me so well, crashing my car so often and putting up with me. And no, this doesn't mean that you're famous....

Thank You.

Memorandum.

The work described within this thesis was performed at the University of Durham between October 1995 and September 1998. This thesis is the work of the author, except where acknowledged by reference, and has not been submitted for any other degree. The copyright of this thesis lies solely with the author. No quotation from it should be published without his prior written consent and information derived from it should be acknowledged.

Part of this work has been the subject of the following:

R. D. Chambers, S. N. Dunn, C. Farren, G. Sandford and A Batsanov.
Free Radical Chemistry Part 9. Additions of Cyclic and Acyclic Alcohols
and Diols To Hexafluoropropene. (In preparation.)

and has been presented at:

15th International Symposium on Fluorine Chemistry, University of
British Columbia, Vancouver, Canada, August 1997.

I.C.I. Poster Session, University of Durham, December 1997.

Graduate Seminar, University of Durham, August 1998.

Nomenclature.

Throughout this work an 'F' in the centre of a ring denotes that all the unmarked bonds on that ring are to fluorine.

Abbreviations.

The following are used throughout this thesis:

DCM	Dichloromethane
GCMS	Gas Chromatography-Mass Spectroscopy
HFP	Hexafluoropropene
IR	Infrared
NMR	Nuclear Magnetic Resonance

Abstract.

Polyfluorinated Compounds *Via* Free-Radical Reactions of Alcohols and Diols.

by Christopher Farren.

Site-selective incorporation of fluorocarbon substituents into organic molecules is a field of continuing interest, and a variety of approaches have been reported. The research described within this thesis is concerned with the functionalisation of C-H bonds adjacent to primary or secondary hydroxyl units *via* free-radical additions to fluoroalkenes.

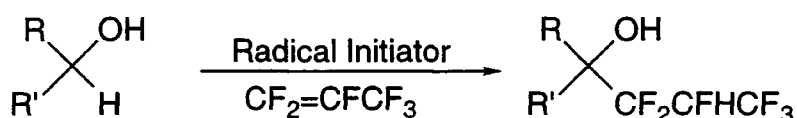

A range of cyclic and acyclic alcohols and diols have been functionalised in this manner, and both substituent and electronic effects on the radical process have been investigated. Further functionalisation of the polyfluoroalkylated products has been performed, giving a range of new fluorinated systems, and an investigation into the chemistry of these systems has begun.

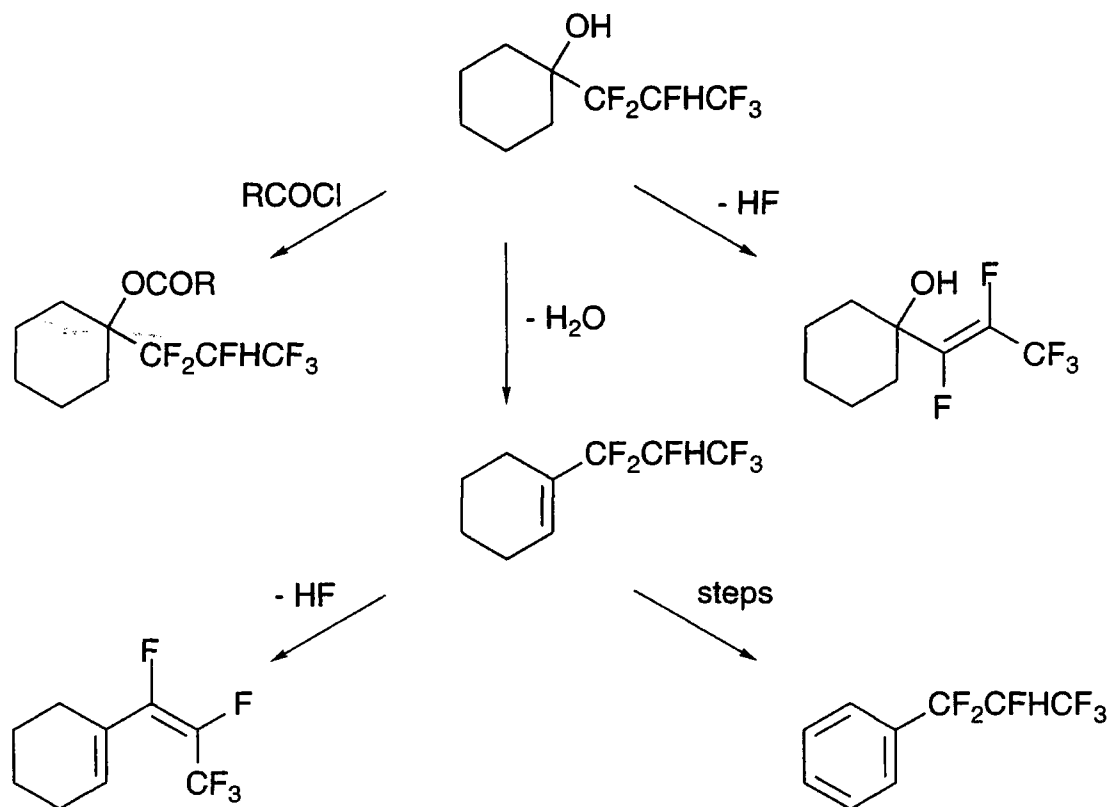

Contents.

<u>Chapter 1: Fluorine in Organic Chemistry.</u>	1
<u>1.1. Introduction.</u>	2
<u>1.2. Applications.</u>	3
<u>1.3. Free-Radical Chain Reactions.</u>	4
1.3.a. Radical Initiation.	4
1.3.b. Radical Stability and Structure.	5
1.3.b.i. Effects of Fluorine on Radical Stability.	6
1.3.c. Radical Reactivity.	9
1.3.d. Orientation of Addition to HFP.	10
1.3.d.i. Electronic Effects.	10
1.3.d.ii. Polar Effects.	11
1.3.e. Chain Transfer.	12
<u>1.4. Radical Additions to Fluoroalkenes.</u>	13
1.4.a. Alcohols and Thiols.	13
1.4.b. Hydrocarbons.	17
1.4.c. Haloalkanes.	19
1.4.d. Alkenes and Alkylbenzenes.	22
1.4.e. Ethers, Esters, Aldehydes and Thioethers.	23
<u>1.5. Conclusions.</u>	30
<u>Chapter 2: Additions of Cyclic Alcohols to Hexafluoropropene.</u>	31
<u>2.1. Introduction.</u>	32
<u>2.2. Cyclohexanol.</u>	32
2.2.a. Orientation of Addition.	33
2.2.b. Site of Addition in Cyclohexanol.	36
2.2.c. Mass Spectroscopy of (46).	39
<u>2.3. Cyclobutanol, Cyclopentanol and Cycloheptanol.</u>	41
2.3.a. Competition Between Cyclopentanol and Cyclopentane.	42
2.3.a. Competition Between Cyclopentanol, Cyclohexanol and Cycloheptanol.	43
<u>2.4. Cyclooctanol, Cyclodecanol and Cyclododecanol.</u>	44
<u>2.5. Conclusions.</u>	46

<u>Chapter 3: Additions of Cyclohexanol Derivatives to Hexafluoropropene.</u>	47
<u>3.1. Introduction.</u>	48
<u>3.2. Alternative Reaction Media.</u>	48
<u>3.3. <i>Cis</i> and <i>Trans</i> 4-Methylcyclohexanols.</u>	49
<u>3.4. 4-<i>Tert</i>-Butylcyclohexanol.</u>	52
<u>3.5. <i>Trans</i>-2-Methylcyclohexanol.</u>	54
<u>3.6. <i>Iso</i>-Menthol.</u>	57
<u>3.7. <i>Exo</i>-Norborneol.</u>	57
3.7.a. Competition Between Cyclohexanol and <i>Exo</i> -Norborneol.	58
<u>3.8. Decahydronaphthanols.</u>	59
<u>3.9. 3-β-Cholestanol.</u>	60
<u>3.10. Conclusions.</u>	61
<u>Chapter 4: Additions of Polyoxygenated Compounds to Hexafluoropropene and Additions of Cyclic Alcohols to Cyclic Perfluoroalkenes.</u>	62
<u>4.1. Introduction.</u>	63
<u>4.2. Cyclic Polyols.</u>	63
4.2.a. Cyclohexanediols.	63
4.2.b. Competition Between Cyclohexane-1,2-diol and Cyclohexane-1,4-diol.	66
4.2.c. Cyclohexane-1,3,5-triol.	66
4.2.d. Cyclopentane-1,3-diol.	67
<u>4.3. Acyclic Diols.</u>	68
4.3.a. Secondary Acyclic Diols.	68
4.3.b. Primary Acyclic Diols.	69
4.3.c. Selectivity and 'Back-Biting'.	71
<u>4.4. Hydroxy-ethers.</u>	75
4.4.a. 2-Hydroxy Tetrahydrofuran.	76
4.4.b. Furfuryl Alcohol.	78
4.4.c. Competition Between Cyclopentanol and 2-Hydroxy Tetrahydrofuran.	79
<u>4.5. Cyclic Fluoroalkenes.</u>	80
4.5.a. Orientation of Addition.	80
4.5.b. NMR Characterisation.	83
<u>4.6. Conclusions.</u>	85

<u>Chapter 5: Adduct Functionalisation.</u>	86
<u>5.1. Introduction.</u>	87
<u>5.2. Dehydrofluorination.</u>	87
<u>5.3. Functionalisation at Hydroxyl.</u>	90
5.3.a. Esterification.	90
5.3.b. Dehydrofluorination of the Ester (126).	94
5.3.c. Silylation.	97
<u>5.4. Dehydration.</u>	98
<u>5.5. Alkene Reactivity.</u>	101
5.5.a. Bromination.	102
5.5.b. Epoxidation.	104
5.5.c. Allylic Bromination	106
<u>5.6. Alkene Dehydrofluorination.</u>	109
<u>5.7. Diene Reactivity.</u>	112
<u>5.8. Conclusions.</u>	115
<u>Instrumental.</u>	116
<u>Chapter 6: Experimental to Chapter 2.</u>	119
<u>Chapter 7: Experimental to Chapter 3.</u>	123
<u>Chapter 8: Experimental to Chapter 4.</u>	127
<u>Chapter 9: Experimental to Chapter 5.</u>	133
<u>Appendix A: NMR Spectra.</u>	A1
<u>Appendix B: Mass Spectra.</u>	B1
<u>Appendix C: IR Spectra.</u>	C1
<u>Appendix D: X-Ray Crystal Structures.</u>	D1
<u>Appendix E: Requirements of the Board of Studies.</u>	E1
<u>Appendix F: References.</u>	F1

Chapter 1: Fluorine in Organic Chemistry.



1.1. Introduction.

Organofluorine chemistry is a field that encompasses a wide range of areas,¹ and fluorine is unique in that replacement of hydrogen by fluorine in organic molecules has only a relatively small effect on the geometry of the system.^{2, 3} However, the high electronegativity of fluorine induces a strong polarisation of the carbon-fluorine bond and fluorine is displaced from organic species as fluoride ion, giving rise to a complementary chemistry to that of hydrocarbon systems,² in which the proton may act as the leaving group.

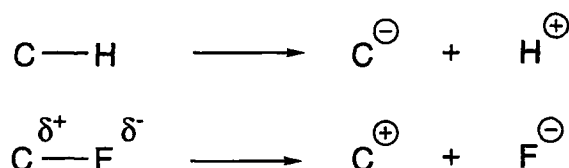

Elemental fluorine itself is very reactive due to the weak intramolecular F-F bond (155 kJmol⁻¹) and the high strengths of the bonds formed between fluorine and other elements.⁴ Indeed, fluorine forms the strongest single bond to carbon in organic chemistry, and this imparts thermal stability to some fluorocarbon systems.

Element, X	H	C	N	O	F	Cl
Van der Waals Atomic Radius (Å)	1.20	1.70	1.55	1.52	1.47	1.75
Pauling Electronegativity	2.1	2.6	3.0	3.4	4.0	3.2
C-X Bond Enthalpy (kJmol ⁻¹)	413	346	301	358	485	339

Table 1.1.i. Physical properties of fluorine.

The thirteenth most abundant element,² fluorine is also the most abundant halogen, and it is thus perhaps surprising that fluorine-containing organic species are very rarely found in nature.^{5, 6} Indeed, from the multitude of compounds isolated and characterised by bio-chemists, only a handful of fluorinated systems have been discovered, and organofluorine chemistry has hence been described as essentially a 'man-made' field of study.

1.2. Applications.

Fluoroplastics and fluoroelastomers have unique surface properties, showing oil and water repellancy, and such materials are thus used in stain prevention treatments and kitchen utensils. Perfluorocarbon fluids generally have relatively low viscosities and high densities, enabling their use as conductive coolants. Such fluids also have high resistivities and dielectric strengths, making them excellent electrical insulators, and perfluorocarbons (e.g. perfluorodimethylcyclohexane) are thus used in packaging 'leak testing', electrical 'hot spot' location and vapour-phase soldering applications.⁷ Furthermore, emulsions of numerous perfluorinated hydrocarbons (e.g. perfluorodecalin), amines (e.g. perfluorotributyl amine) and ethers (e.g. perfluoro-1-butyltetrahydrofuran) have been investigated as 'blood substitutes', as the solubility of oxygen and carbon dioxide is extremely high in these fluids.

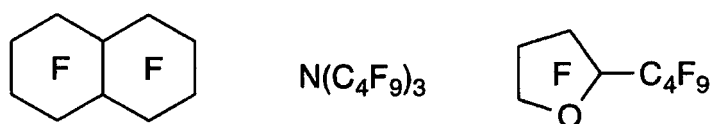

Potential blood substitutes

Polyfluorinated alkanes and ethers are widely used as refrigerants (CF₂Cl₂, CFC₁₃), inhalation anaesthetics (CF₃CHClBr, CHF₂OCHClCF₃) and X-ray contrast enhancement agents for lung and gastrointestinal imaging (n-C₆F₁₃Br, n-C₈F₁₇Br). Indeed, the pharmaceutical and agrochemical industries utilise a diverse range of fluorinated compounds, in applications including anti-cancer drugs (5-fluorouracil), anti-depressants (Prozac) and weed killers (trifluralin).

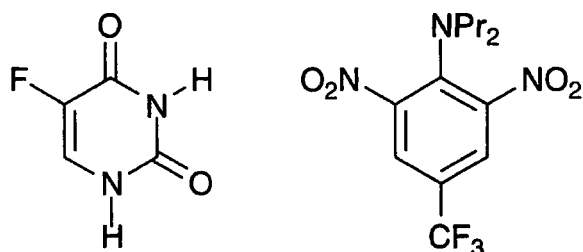

5-Fluoro uracil

Trifluralin

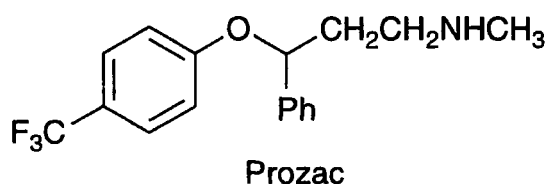

Prozac

1.3. Free-Radical Chain Reactions

The first radical was identified at the turn of the century,⁸ but in the years that followed radical functional group interconversions were not studied in the same methodological manner as were ionic reactions, and steric and electronic influences on radical systems were not fully investigated. Over the last two decades, however, much interest has arisen in this subject and a number of good reviews on the subject are now available.^{9, 10}

This project concerns the additions of carbon-centred radicals to fluoroalkenes, especially hexafluoropropene (HFP), and thus a review of the theory behind such reactions will be presented. Free radical additions to HFP occur *via* the following chain mechanism, and the following sections will discuss each aspect of this process.

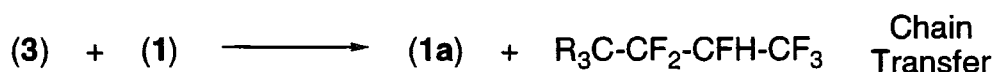
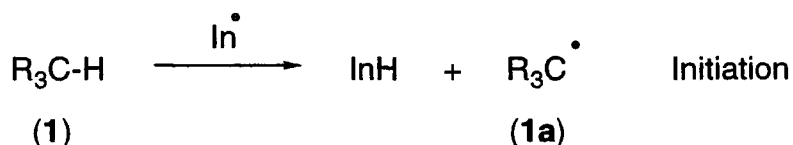

1.3.a. Radical Initiation.

Homolytic carbon-hydrogen bond rupture creates the first radical of the chain (1a), and can be induced by either chemical (peroxide) or energetic (thermal, UV, γ -ray) methods.¹⁰

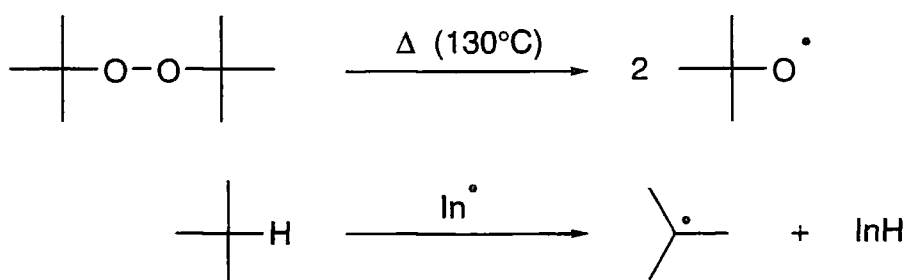

The preferred site of hydrogen atom abstraction in a substrate (**1**) is determined by the relative carbon-hydrogen bond dissociation energies (BDEs) within the system, and weaker C-H bonds undergo more rapid hydrogen atom abstraction (table 1.3.a.i.).

Entry	Radical Precursor ^a	Typical BDE (kJmol ⁻¹)
1	CH ₃ -H	439
2	CH ₂ F-H	431
3	RCH ₂ -H	422
4	R ₂ CH-H	414
5	(NO ₂)CH ₂ -H	402
6	R ₃ C-H	397
7	HOCH ₂ -H	393
8	CH ₂ =CH-CH ₂ -H	360
9	PhCH ₂ -H	356
10	Ph ₃ C-H	322

Table 1.3.a.i. C-H Bond dissociation energies.

a) R = alkyl.

1.3.b. Radical Stability and Structure.

The bond dissociation energy of a radical precursor is also considered to give a good estimate of the *stability* of the derived species, lower BDEs indicating increasing radical stabilisation.¹¹ Secondary alkyl radicals are thus more stable than primary alkyl radicals (entries 3 and 4, table 1.3.a.i.), reflecting the increased inductive electron donation towards the electron deficient radical centre.

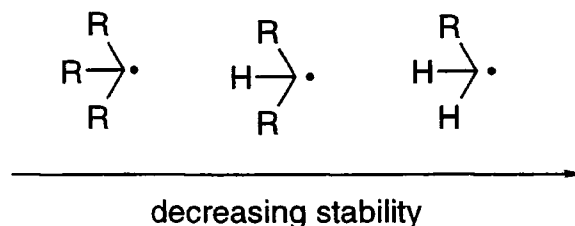

In fact, all mono-substituents at a saturated carbon centre reduce the carbon-hydrogen BDE in comparison to methane (table 1.3.a.i.), and this is attributed to the increased number of molecular orbitals available to interact with the derived radical centre.

Heteroatoms adjacent to a developing radical site may display conjugation between the non-bonding pair(s) and the radical single electron.

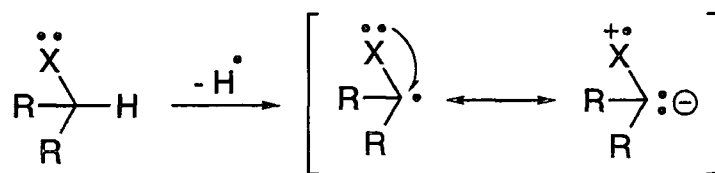

X = OR, NR₂, SR, Hal.

This resonance effect increases electron density at the reaction centre, stabilising the derived radical,² and is reflected by the relatively low BDE of carbon-hydrogen bonds adjacent to oxygen (entries 1 and 7, table 1.3.a.i.). Thus radicals derived from alcohols, ethers and amines are strongly stabilised, and similarly allylic and benzylic radicals are also stabilised by conjugation (with the adjacent π -system). This can alternatively be described by molecular orbital theory, with the interaction between the radical singly occupied molecular orbital (SOMO) and the heteroatom lone pair (or adjacent π -bond) appearing as below.¹²

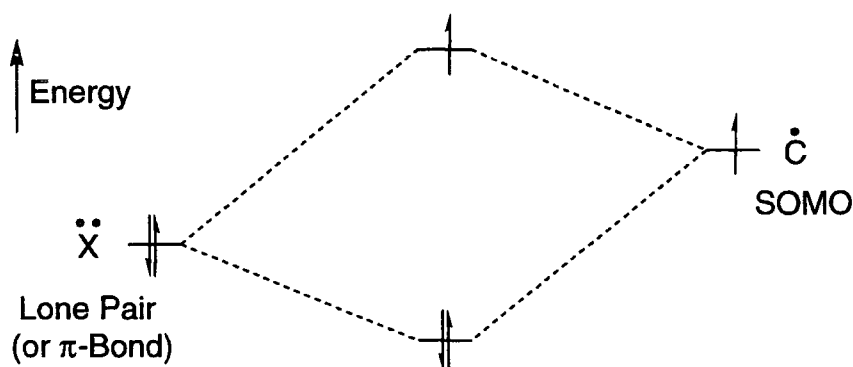

1.3.b.i. Effects of Fluorine on Radical Stability.

Dolbier¹³ has suggested that when X (above) is fluorine, the high electronegativity of the heteroatom tends to *destabilise* the electron deficient radical centre *via* σ -electron withdrawal, and that there is a complex interplay between this effect and conjugative stabilisation. A single fluorine substituent stabilises a radical centre, as is reflected in the BDEs of methane and fluoromethane (entries 1 and 2, table 1.3.a.i.). Multiple fluorine substitution, in contrast, results in *destabilisation* and trifluoromethane has a higher carbon-hydrogen BDE (452 kJmol⁻¹) than that of methane. Experimental support for this order of radical stability was provided by the fragmentation of fluorinated *tert*-butoxy radicals.¹⁴

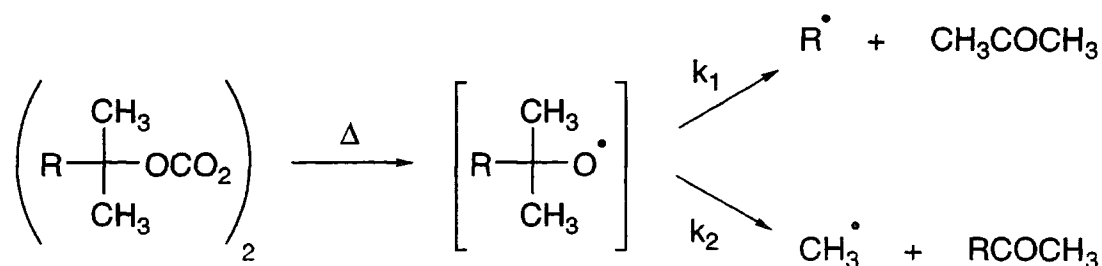

R	k_1/k_2 (k_{rel})
CH ₃	1.0
CH ₂ F	9.0
CF ₃	0.08

Table 1.3.b.i.i. Radical Dissociation Rates.

The effect of the fluorine substituents on the stability of the radical R is reflected in the rates of carbon-carbon bond fission, and while a single fluorine atom increases the stability of R (and hence the rate of C-R bond dissociation), three fluorine substituents induce destabilisation of R and the rate of dissociation is low. This destabilisation reflects the *structure* of the derived trifluoromethyl radical.

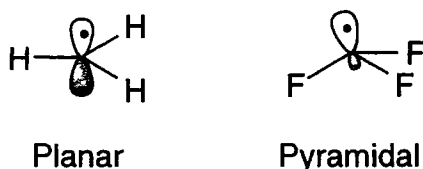

Methyl radicals are planar,¹⁵ but the trifluoromethyl radical is pyramidal¹⁶ with a significant energy barrier to inversion.¹⁷ Pauling¹⁸ and later Dolbier¹³ have argued that this deformation may be due to the high electronegativity of fluorine, which inductively induces a re-hybridisation of the radical site to take advantage of the thermodynamic stability of carbon-fluorine bonds that are high in *p*-character. However, it has also been suggested that electron pair repulsion is the major factor,¹⁶ and that pyramidalisation reduces the destabilising electronic repulsion² of a second heteroatom.

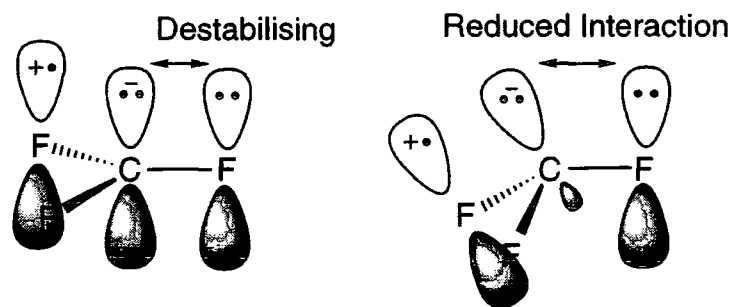

Bernardi and co-workers¹⁷ believe that the inductive effect is dominant in the case of fluorine, but in either case the stabilising resonance between the radical SOMO and the fluorine lone pairs *decreases* with increasing deviation from planarity and conjugative stabilisation of the radical centre is reduced.

It has been argued¹³ that the only significant effect of a β -fluorine substituent is that of inductive destabilisation, C-F hyperconjugation apparently not being observed due to the high electrophilicity of fluorinated radicals. Unfortunately little BDE data is available for β -fluorinated ethanes, but the potential for inductive destabilisation is reflected in the trend of the *calculated* BDE's (table 1.3.b.i.ii.).

Entry	Radical Precursor ^a	Calculated BDE (kJmol ⁻¹)
1	CH ₃ CH ₂ -H	408
2	CH ₂ FCH ₂ -H	416
3	CHF ₂ CH ₂ -H	423
4	CF ₃ CH ₂ -H	426

Table 1.3.b.i.ii. Calculated C-H Bond dissociation energies.

It is worth noting that up to this point we have only been concerned with the *thermodynamic* stability of radicals, but in fact some highly fluorinated radicals also have increased *kinetic* stability. One such radical is Scherer's radical,¹⁹ which persists at room temperature.

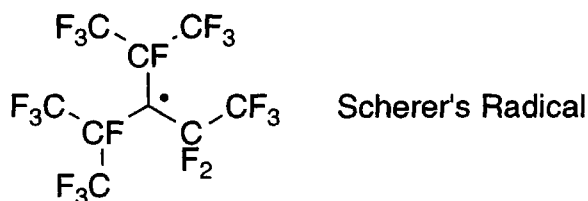

It is argued that the kinetic stability of this species arises from steric effects, the radical centre being buried within the surrounding fluorine substituents.

1.3.c. Radical Reactivity.

The addition of carbon-centred radicals to alkenes is strongly exothermic, as a σ -bond is formed and a π -bond is broken. Furthermore, addition proceeds *via* an unsymmetrical transition state which occurs at a very early stage on the reaction coordinate.²⁰ Calculations for the model system of a methyl radical reacting with ethene suggest that the radical approaches the double bond at approximately the tetrahedral angle, perpendicular to the plane of the π system, and the carbon-carbon separation in the transition state²¹ is ca. 2.3Å.

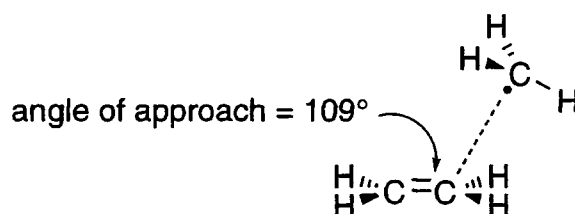

Hence *polar effects* are dominant in radical additions to alkenes, and indeed not only are secondary alkyl radicals more *stable* than primary alkyl radicals (section 1.3.a.) but secondary radicals are also more *nucleophilic* due to the increased electron density at carbon. Such radicals thus react well with electron deficient alkenes. In contrast, strongly electron withdrawing substituents at the radical centre such as cyano, fluorine or trifluoromethyl tend to have the opposite effect, the derived radicals reacting well with electron rich systems. This is reflected by radical additions to acrylonitrile (4), where the low degree of telomerisation (short chain polymerisation, i.e. multiple propagation steps before chain transfer) observed is attributable to the relative nucleophilicities (table 1.3.c.i.) of the radicals present in the reaction mixture.⁸

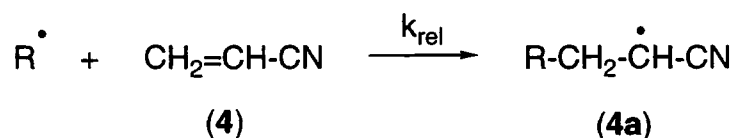

Radical type	Primary Alkyl	Secondary Alkyl	R-CH ₂ - $\dot{\text{C}}$ H-CN
k_{rel}	1.0	7.3	1.5x10 ⁻³

Table 1.3.c.i. Radical addition rates.

Radicals derived from alcohols, ethers and amines are thus both strongly stabilised (section 1.3.b.) and rendered *highly* nucleophilic *via* conjugation with the heteroatom lone pair, and their reactions with electrophiles are highly efficient and are susceptible to the same factors that influence addition of ionic nucleophiles.

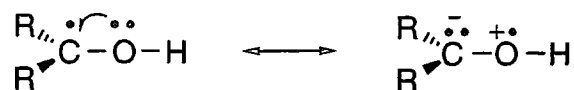

1.3.d. Orientation of Addition to HFP.

Inductive electron withdrawal by both fluorine and fluoroalkyl groups renders fluoroalkenes electrophilic,^{2, 22, 23} and there are two factors that influence the orientation of addition of a nucleophile (or nucleophilic radical) to an unsymmetrical fluoroalkene.²⁴

1.3.d.i. Electronic effects.

In the carbanionic intermediate (**5a**) arising from nucleophilic attack on tetrafluoroethene (TFE) (**5**), there are two conflicting electronic effects of fluorine.

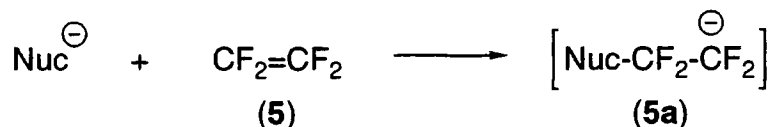

A fluorine atom attached *directly* to the carbanionic centre would be expected to stabilise the system by σ -inductive electron withdrawal ($-I_{\sigma}$), but this is offset^{2, 25} by electron pair repulsions ($+I_{\pi}$) (section 1.3.b.) and the overall effect may even be destabilisation with respect to hydrogen. In comparison, the σ -inductive electron withdrawal of a fluoroalkyl group strongly stabilises the carbanionic intermediate.²²



The stabilising effect of a *fluoroalkyl* group on a carbanionic centre can be illustrated²⁴ by the data in table 1.3.d.i.i. The acidity of $(\text{CF}_3)_3\text{CH}$ is comparable to that of a 1,3-keto ester, reflecting the stability of the perfluoro-*tert*-butyl anion formed by deprotonation.

Compound	CF ₃ H	(C ₆ F ₁₃)CF ₂ H	(CF ₃) ₂ CFH	(CF ₃) ₃ CH
Derived Anion	CF ₃ ⁻	(C ₆ F ₁₃)CF ₂ ⁻	(CF ₃) ₂ CF ⁻	(CF ₃) ₃ C ⁻
pK _a	31	30	20	11

Table 1.3.d.i.i. Acidity measurements on fluoroalkanes.

Nucleophilic attack at an unsymmetric fluoroalkene such as HFP (2) can thus be predicted to occur at the *terminal* end of the double bond, generating the carbanion with most fluoroalkyl substituents. Thus route 1 is favoured over route 2 below.

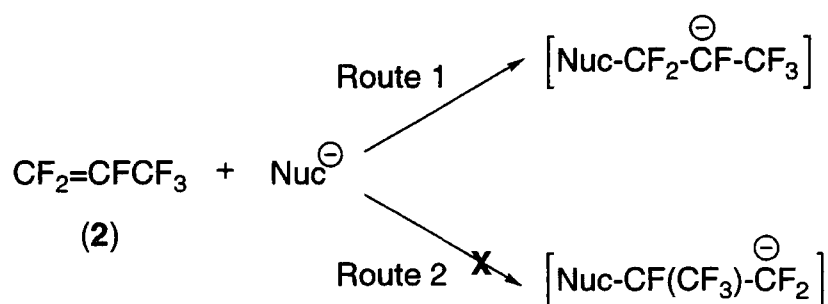

1.3.d.ii. Polar effects.²⁶⁻²⁸

Frontier molecular orbital theory dictates that the lowest unoccupied molecular orbital (LUMO) of an electron deficient alkene interacts with the highest occupied molecular orbital (HOMO) of a nucleophile upon reaction, and strongly electron withdrawing substituents on an alkene are known to lower LUMO orbital energies.²⁹

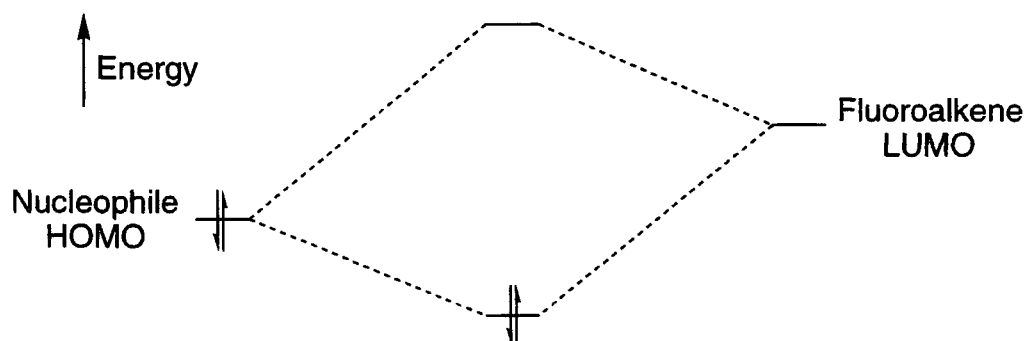

The smaller the energy difference between HOMO and LUMO the larger the stabilising effect when the two reactants approach one another,²⁸ and incorporation of a trifluoromethyl group increases the potential for HOMO-LUMO overlap at the *opposite end* of the double bond.^{30, 31}

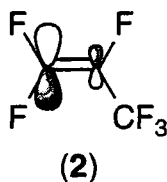

HFP (2) is thus very *polar*, the terminal site being the more electrophilic, and both electronic and polar effects ensure that addition of a nucleophile or nucleophilic radical to HFP occurs selectively at this site.

1.3.e. Chain Transfer.

Nucleophilic addition of radical (1a) to HFP generates radical (3), which is rendered *electrophilic* in nature by the combined inductive electron withdrawal of the fluorine substituent and the two adjacent fluoroalkyl groups (section 1.3.b.).



Further reaction of (3) with the electron deficient fluoroalkene is thus disfavoured, and rapid hydrogen abstraction from the relatively rich substrate (1) is the dominant pathway, regenerating radical (1a). This is analogous to the chemistry of other electrophilic radicals, such as alkoxide, for which hydrogen atom abstraction is a typical process and addition to carbon-carbon multiple bonds is disfavoured.¹⁰

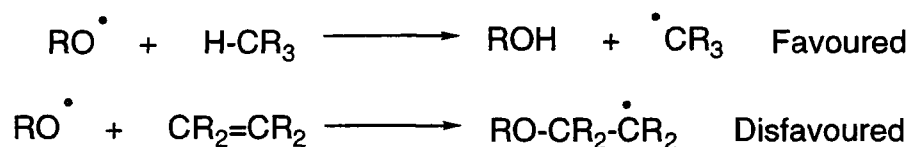

1.4. Radical Additions to Fluoroalkenes.

It is the aim of the next section to review the literature coverage concerning radical additions of varying substrates to fluoroalkenes, especially HFP.

1.4.a. Alcohols and Thiols.

In 1955, Lazerte *et al*³² detailed the dibenzoyl peroxide initiated radical addition of methanol to a variety of fluoroalkenes, and identified the mechanism as being a carbon-centred radical chain process.³³ Using a 1:1 ratio of methanol to HFP yielded the mono-adduct (**6**) in good yield, and the effects of temperature and reagent purity on the course of the reaction were described.

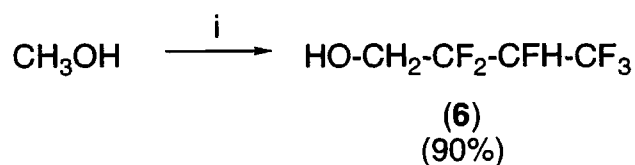

i) HFP, di-benzoyl peroxide, 80°C, 15 hours.

Only addition to the terminal site of HFP was detected, reflecting the high nucleophilicity of radicals derived from alcohols (section 1.3.b.). Larger terminal fluoroalkenes also gave good yields of the analogous 1:1 adducts with methanol (**6a**), but larger alcohols were reported to give lower yields (**6b**).

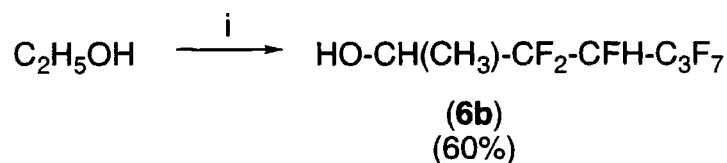
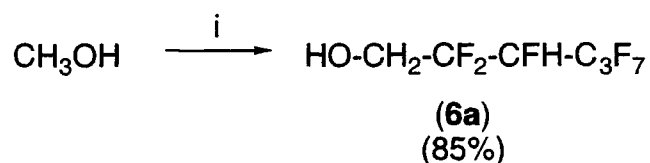

i) CF₂=CF-C₃F₇, di-benzoyl peroxide, 80°C, 15 hours.

Notably, however, only addition to carbon sites adjacent to oxygen was detected (**6b**), and this reflects the stability of radicals derived from alcohols. Not only does the oxygen atom conjugatively stabilise an adjacent radical (section 1.3.a.), but the electronegativity of the heteroatom renders radicals at other sites in the alcohol less

nucleophilic, and this effect is sufficient to make the addition to the electrophilic fluoroalkene site-specific.

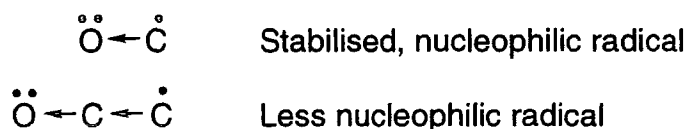

Addition of alcohols to HFP was further investigated by Murumatsu³⁴ and Haszeldine³⁵ (table 1.4.a.i.).

Alcohol	Initiator (°C)	Product ^a	Yield ^b
MeOH	γ-ray (25)	R _{FH} CH ₂ OH	76 ^c
	thermal (280)		85 ^d
	U.V. (40)		95 ^d
	peroxide (140)		93 ^d
EtOH	γ-ray (25)	R _{FH} C(Me)HOH	99 ^c
	thermal (280)		79 ^d
	U.V. (40)		92 ^d
	peroxide (140)		86 ^d
iPrOH	γ-ray (25)	R _{FH} C(Me) ₂ OH	100 ^c
	thermal (280)		86 ^d
	U.V. (40)		95 ^d
	peroxide (140)		89 ^d
CF ₃ CH ₂ OH	thermal (320)	R _{FH} C(CF ₃)HOH	95 ^d
(CF ₃) ₂ CHOH	thermal (355)	No reaction	0 ^d
R _{FH} CH ₂ OH	thermal (380)	No reaction	0 ^d

Table 1.4.a.i. Radical additions of alcohols to HFP.

a) R_{FH} = CF₃CFHCF₂-

b) Based on HFP consumed.

c) Ref. ³⁴

d) Ref. ³⁵

Overall, there is little difference in yield with the initiation method used, and only when the derived radical has reduced nucleophilicity due to inductive electron withdrawal (e.g. (CF₃)₂CHOH) or is both sterically and electronically deactivated (e.g. R_{FH}CH₂OH) is the alcohol unreactive. More recently, Paleta *et al*³⁶ have shown that

polyfluoroalkylated *diols* can also be generated by free-radical addition to HFP. Reaction conversions were poor, however, and ethene-1,2-diol and propane-1,2-diol were reported to be unreactive. Butane-1,4-diol (**7**) gave the mono- (**8**) and 1,4-di-adducts (**9**) in low yield upon reaction with HFP, polyfluoroalkylation of the solvent (methanol) being predominant.

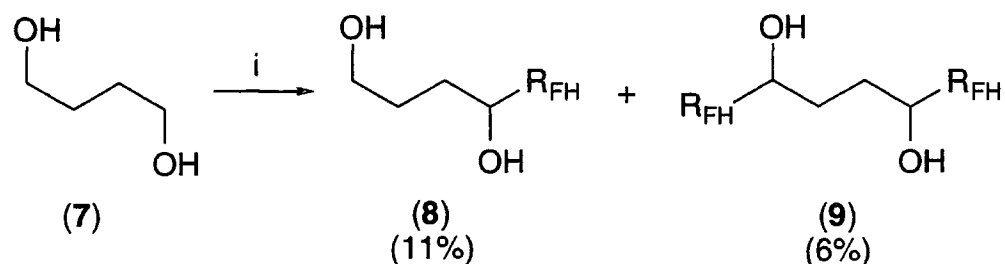

- i) HFP, methanol, UV irradiation, -10°C.
- ii) $R_{FH} = CF_2CFHCF_3$

Interestingly, butane-1,3-diol is described in the same publication as being unreactive towards HFP under either photochemical or peroxide initiated radical conditions, and the present work re-examines this reaction (section 4.3.c.). Furthermore, butane-1,4-diol was reported to react with HFP in the presence of base to obtain the bis-ether (**10**) *via* nucleophilic addition.

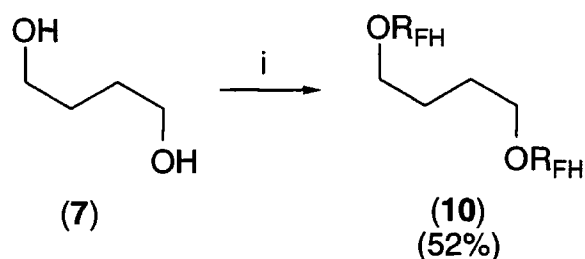

- i) HFP, CH_3CN , Na_2CO_3 , 0-20°C.
- ii) $R_{FH} = CF_2CFHCF_3$

Dunn³⁷ continued the investigation into radical reactions of alcohols with HFP, and developed methodology for the incorporation of hexafluoropropyl groups into cyclic alcohols and diols, despite previous reports that cyclohexanol is unreactive towards HFP under radical conditions.³²

Radical reactions of alcohols with substituted fluoroalkenes have also been reported, and perfluorovinyl ethers gave 1:1 adducts with primary and secondary alcohols under analogous conditions.³⁸



i) acetone, UV irradiation, room temperature.

ii) $R^1 = R^2 = H, Me$; $R_F = -OC_3F_7, -OCF_2CF(CF_3)-O-C_3F_7$

Addition again occurs predominantly at the terminal, more electrophilic end of the fluoroalkenes, with only traces of the regioisomeric adducts being detected, and this reflects the polar effects outlined previously. The reactivity of the fluorinated vinyl ethers was comparable to that of HFP, and a number of solvents were examined for the reaction, with tertiary alcohols and trifluoroethanol being suitable but acetonitrile inhibiting the reaction completely. Perfluoroallylchloride (PAC, $CF_2=CFCH_2Cl$) (**11**) is also susceptible to radical attack, reacting with methanol to give the unsaturated alcohol (**12**).³⁹

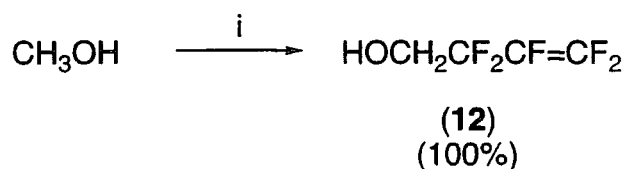

i) PAC, di-*tert*-butyl peroxide, 140°C

Attack at the terminal site in the fluoroalkene is once more predominant, this being attributed to both polar effects and the steric demand of the chlorodifluoromethyl group. However, cleavage of the carbon-chlorine bond (typical C-Cl BDE = 339 kJmol⁻¹) in the radical intermediate (**11a**) is both thermodynamically and kinetically favoured over intermolecular chain transfer (HOCH₂-H BDE = 393 kJmol⁻¹) and the -CF₂CFHCF₂Cl adduct is not formed.

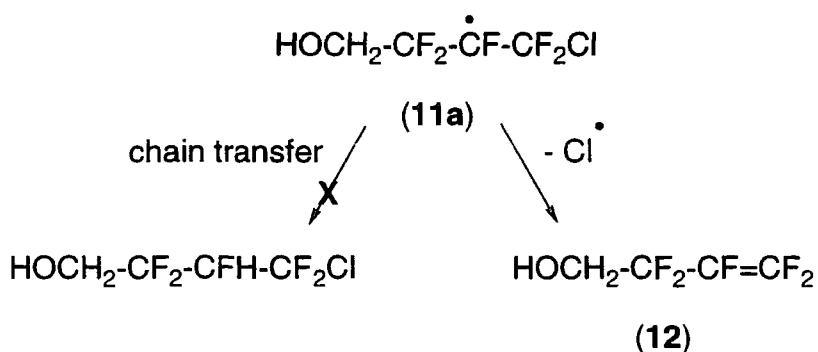

Radicals derived from thiols are *sulphur*-centred, the S-H bond being relatively weak (BDE = 368 kJmol⁻¹) in comparison with most carbon-hydrogen bonds, and Harris⁴⁰ demonstrated that methanethiol reacts with HFP under radical conditions to generate 1:1 adducts *via* the sulphur atom. Addition to the terminal site in the fluoroalkene is preferred (**13**) but small amounts of the regioisomer (**14**) were generated, reflecting the reduced nucleophilicity of the thio-radical.

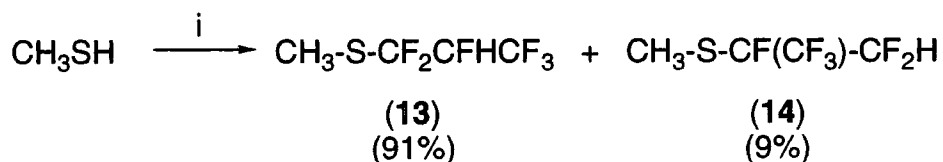

i) HFP, either X-ray or UV irradiation.

Furthermore, the radical derived from trifluoromethylthiol is rendered much less nucleophilic than that derived from methanethiol due to the high inductive electron withdrawal of the trifluoromethyl group, reacting much less selectively with HFP and forming a near equivalent mixture of the two regioisomeric adducts (**15**) and (**16**).

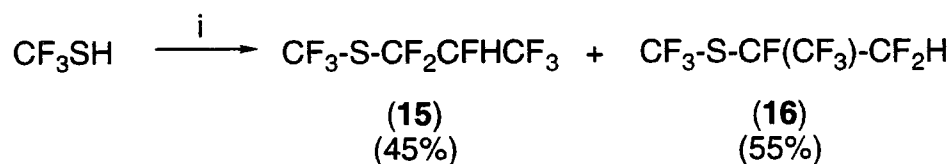

i) HFP, either X-ray or UV irradiation.

1.4.b. Hydrocarbons.

Small hydrocarbon alkanes yield mono-addition products with HFP⁴¹ (table 1.4.b.i), with longer chain hydrocarbons giving more complex mixtures of mono- and di-adducts.⁴²

Alkane	Initiation (°C)	Product(s) ^a	Yield(s) ^b
CH ₃ CH ₂ CH ₃	γ-ray (25)	(CH ₃) ₂ CHR _{FH} + CH ₃ CH ₂ CH ₂ R _{FH}	21 + 2 ^c
(CH ₃) ₃ CH	γ-ray (25)	(CH ₃) ₃ CR _{FH}	42 ^c
n-C ₄ H ₁₀	γ-ray (25) thermal (295) U.V. (40) peroxide (130)	CH ₃ CH(R _{FH})- CH ₂ CH ₃ + CH ₃ CH(R _{FH})- CH ₂ CH ₂ R _{FH} (+ trace species)	6 + 11 ^c 10 + 7 ^d 39 + 11 ^d 18 + 40 ^d

Table 1.4.b.i. Radical additions of hydrocarbons to HFP.

a) R_{FH} = CF₂CFHCF₃

b) Yield(s) of each product, based on HFP consumed. NR = not reported.

c) Ref. ⁴¹

d) Ref. ⁴²

Addition to secondary sites is observed to be preferred over addition to primary sites, as rationalised previously on the basis of the carbon-hydrogen BDEs and the stability of the derived radicals (section 1.3.a.). Furthermore, only small amounts of the regioisomers arising from radical addition to the central carbon atom in HFP were detected, the reaction again being essentially regioselective due to the nucleophilicity of alkyl radicals. Cyclic hydrocarbons such as (17) also react with HFP under radical conditions,⁴¹ giving mono- (18) and di-addition compounds (19).

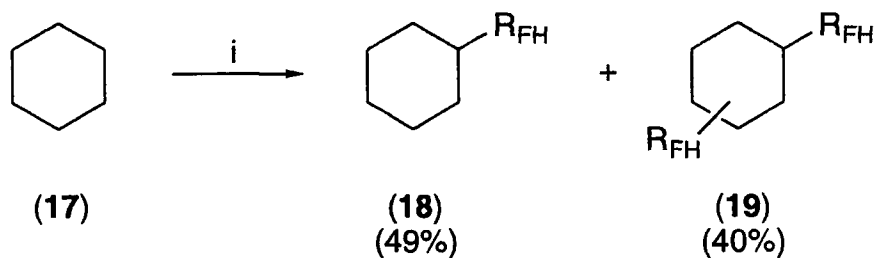

i) HFP, di-*tert*-butyl peroxide, 140°C.

ii) R_{FH} = CF₂CFHCF₃

Spink⁴³ continued to investigate the use of hydrocarbons in radical processes, and additions of acyclic, cyclic and polycyclic hydrocarbons to HFP gave the corresponding adducts.

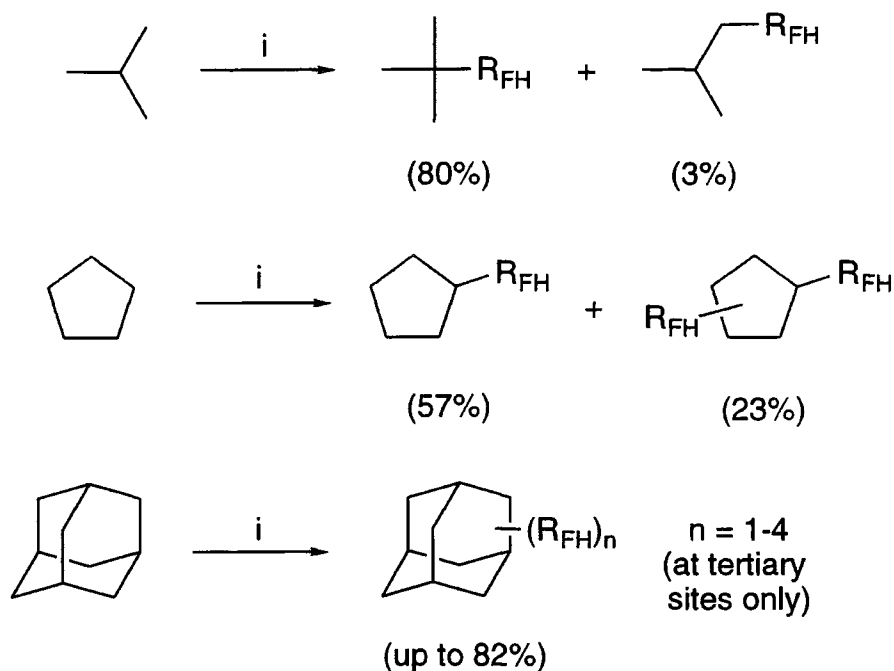

i) HFP, di-*tert*-butyl peroxide, 140°C, 24 hours.

ii) $\text{R}_{\text{FH}} = \text{CF}_2\text{CFHCF}_3$

iii) n varies markedly with respect to the molar ratio of HFP.

1.4.c. Haloalkanes.

The presence of halogens or halo-alkyl groups is tolerated by the radical addition process,⁴⁴ and adducts with HFP were obtained in good yields (table 1.4.c.i.).

Haloalkane	Initiation (°C)	Product ^a	Yield ^b
CH_3Cl	thermal (280)	$\text{CH}_2\text{ClR}_{\text{FH}}$	75 ^c
CH_2Cl_2	thermal (280)	$\text{CHCl}_2\text{R}_{\text{FH}}$	85 ^c
CHCl_3	thermal (280)	$\text{CCl}_3\text{R}_{\text{FH}}$	80 ^c
CH_3F	thermal (280)	$\text{CH}_2\text{FR}_{\text{FH}}$	76 ^c
CH_2F_2	thermal (280)	$\text{CHF}_2\text{R}_{\text{FH}}$	85 ^c
CH_3CHF_2	thermal (290)	$\text{CH}_3\text{CF}_2\text{R}_{\text{FH}}$	65 ^c
CH_3CF_3	thermal (310)	$\text{CF}_3\text{CH}_2\text{R}_{\text{FH}}$	71 ^c

Table 1.4.c.i. Radical additions of haloalkanes to HFP.

a) $\text{R}_{\text{FH}} = \text{CF}_2\text{CFHCF}_3$

b) Based on HFP consumed.

c) Ref. ⁴⁴

When a choice is available, reaction preferentially occurs at the carbon-hydrogen bond adjacent to the halogen(s) (e.g. CH_3CHF_2) due to the slightly reduced bond strength and increased stability of the derived radical (section 1.3.a.). However, small amounts of the regioisomeric adducts arising from attack at the central unsaturated carbon atom of HFP were detected in each case, reflecting the reduction in nucleophilicity of halo-stabilised radicals induced by the inductive electron withdrawal of the halogen(s).

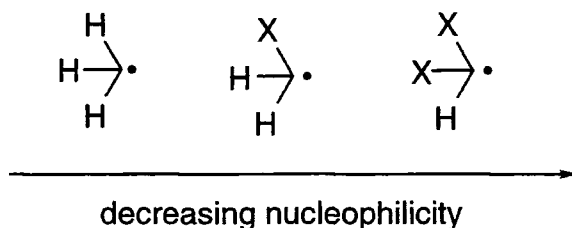

X = Halogen.

Radical co-telomerisation of HFP and 1,1-difluoroethene (vinyl difluoride, VDF) has been investigated for a range of applications,⁴⁵ including surfactant and specialist polymer synthesis.⁴⁶ Telomerisations involving HFP are reported to be extremely difficult, requiring elevated temperatures or photolysis,⁴⁷ yet it was found that room temperature γ -ray induced co-telomerisation of HFP-VDF mixtures occurred in good conversions when bromofluorocarbons were used as telogens (table 1.4.c.ii.).

CF_2Br_2 (mol)	VDF (mol)	HFP (mol)	Conditions	VDF/HFP in telomer	Conversion
1	1	1	γ	2.0	59
2	1	1	γ	1.9	82
2	1	2	γ	1.0	56
2	1	1	γ , C_6H_6	-	1.2
2	1	1	γ , Freon 113	1.4	50
2	1	1	γ , CS_2	1.9	59

Table 1.4.c.ii. Telomerisation results.

A range of telomers were produced, using varying telogen and fluoroalkene ratios, and solvent effects were found to be marginal except when benzene was used, the aromatic acting as an efficient radical trapping agent and resulting in very low conversions. The predominant processes occurring in the telomerisation mixture can be represented as follows:

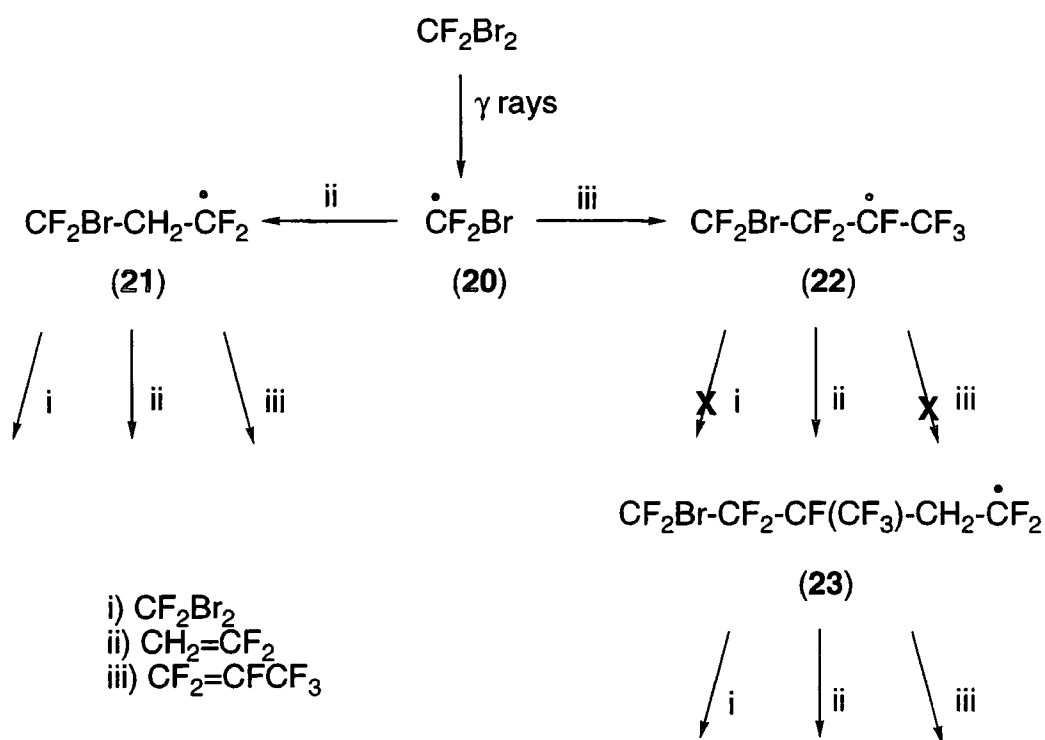

The radical (20) derived from the telogen, being rendered electrophilic by the combined inductive electron withdrawal of three halogen substituents, preferentially reacts with VDF, the more electron-rich alkene (ratio of approx. 5:1, as determined by a comparison of the CF_2BrCH_2 - and CF_2BrCF_2 - end-group occurrences in the telomer). Similarly, the minor radical (22) generated by addition of (20) to HFP is also rendered electrophilic by its fluoroalkyl substituents, to the extent that it will not react further with the bromofluorocarbon or HFP but only with VDF, generating radical (23). Both (21) and (23), however, are rendered sufficiently nucleophilic by the methylene spacer between the radical centre and the fluoroalkyl chain to have all the propagation options available, and overall incorporation of HFP was increased by raising the molar ratio of the perfluoroalkene in the starting mixture.

Radical additions of *perfluoroalkyl* radicals to fluoroalkenes is also a topic of current interest,⁴⁸ and the reaction of perfluoroallyl chloride (PAC) (11) with perfluorobutyl iodide under thermal initiation gave the terminal perfluoroalkene (25), this work complementing early reports by Aspey *et al.*⁴⁹

Indane (or cyclopentane) formation occurs in competition with chain transfer, and the relative composition of the product mixture is reported to be pressure dependent. High pressure reactions gave a greater amount of simple addition products, more HFP being dissolved in the liquid phase of the reaction where there is an excess of alkyl benzene and chain transfer is favoured. Conversely, a lower pressure causes a higher degree of reaction to occur in the vapour phase, where there is a deficiency of alkyl benzene, and reactions of the intermediate radicals *other* than chain transfer, such as indane formation, compete effectively.

Reaction Conditions	Adducts (%)	Indanes (%)
Glass tube (low pressure)	73.5	21.5
Autoclave (high pressure)	81.5	10.0

Table 1.4.d.i. Product distributions for alkylbenzene additions to HFP.

1.4.e. Ethers, esters, aldehydes and thioethers.

Ethers,^{12, 54-59} esters⁶⁰ and aldehydes^{32, 61} are all reported to react preferentially at sites adjacent to oxygen (table 1.4.e.i), the carbon-hydrogen BDEs being low and the derived carbon-centred radical intermediates being both stabilised and rendered highly nucleophilic by heteroatom lone pair interactions (section 1.3.a.).



Substrate	Initiation (°C)	Product(s) ^a	Yield(s) ^b
	γ-ray (25) thermal (280) U.V. (40)		68 ^c 61 ^d 65 ^e
	γ-ray (25) U.V. (40)	 + 	44 + 57 ^f NR + 39 ^e
	γ-ray (25) γ-ray (25), 2HFP U.V. (40) peroxide (80)	 + 	59 + 34 ^g 5 + 95 ^g 73 + NR ^e 80 + NR ^g
	γ-ray (25) thermal (300) U.V. (40)		70 ^h 10 ^d 82 ⁱ
	peroxide (80)		39 ^j
	peroxide (80)		70 ^k

Table 1.4.e.i. Radical additions of oxygen-containing species to HFP.

a) $R_{FH} = CF_2CFHCF_3$

b) Yields of each product, based on HFP consumed. NR = not reported.

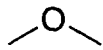
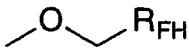
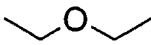
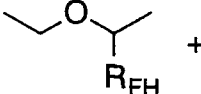
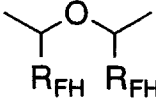
c) Ref. ⁵⁵

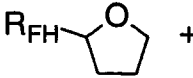
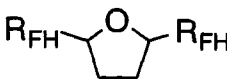
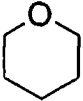
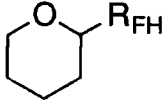
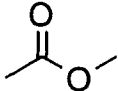
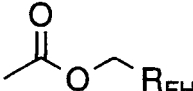
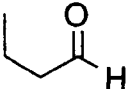
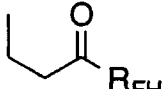
d) Ref. ⁵⁸

e) Ref. ¹²

f) Ref. ⁶¹

g) Ref. ⁵⁷

h) Ref. ⁵⁶

i) Ref. ⁵⁹

j) Ref. ⁶⁰

k) Ref. ³²

Ethers and polyethers are perhaps the class of compounds that have been most intensively studied as reagents in radical additions to fluoroalkenes, and both substituent⁵⁶ and stereoelectronic⁶² effects have been examined. Larger alkyl chains promote poly-addition to acyclic ethers (26) (table 1.4.e.ii.).

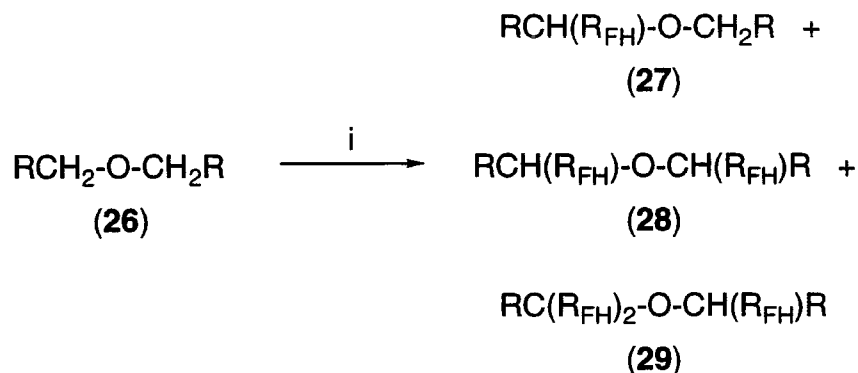

i) HFP, γ -rays, room temperature.

ii) $\text{R}_{\text{FH}} = \text{CF}_2\text{CFHCF}_3$

R Group	Product Distribution			Conversion (%)
	Mono-adduct (27) (%)	Di-adduct (28) (%)	Tri-adduct (29) (%)	
H	100	-	-	70
Me	47	53	-	100
Et	30	70	-	80
n-Pr	23	40	37	70

Table 1.4.e.ii. Product distribution of reactions of acyclic ethers with HFP.

Additions to ethers bearing electron withdrawing groups (30) have highlighted the effects of radical polarity.⁶³

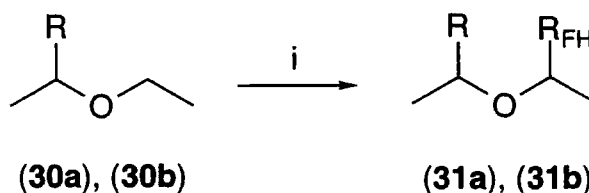

i) HFP, γ -rays, room temperature.

ii) $\text{R} = \text{H}$ (30a), R_{FH} (30b)

iii) $\text{R}_{\text{FH}} = \text{CF}_2\text{CFHCF}_3$

Polyfluoroalkylated ether (**30b**) is less reactive than the unsubstituted analogue (**30a**), the nucleophilicity of the derived radical (adjacent to oxygen) being reduced by the inductive electron withdrawal of the fluorinated group. The radical formed adjacent to to R_{FH} in (**30b**) is stabilised by the "cpto-dative" effect, but addition is directed towards the oxygen-stabilised site *furthest* from the haloalkyl substituent, this site being more accessible and inductively deactivated to a lesser degree.

Reactivity of *cyclic* ethers is dependent upon ring size. Resonance stabilisation by oxygen requires the radical centre to achieve planarity, and there is a significant energy barrier to the associated ring flexation in the six-membered pyran system.

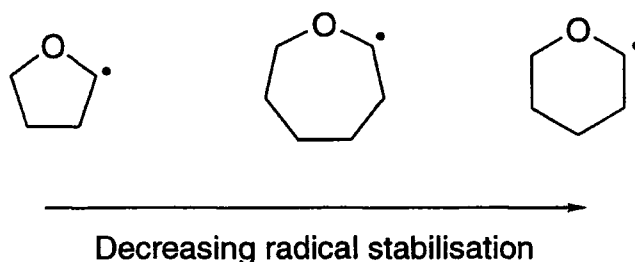

Additions of cyclic ethers to substituted fluoroalkenes have been reported by Paleta.⁶⁴

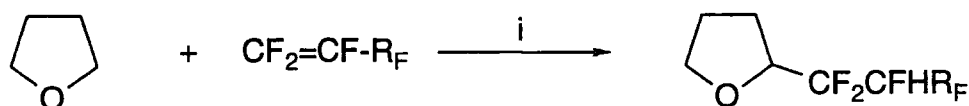

i) acetone, UV irradiation, room temperature.

ii) $R_F = -OC_3F_7, -OCF_2CF(CF_3)-O-C_3F_7$

Reaction again occurs predominantly at the terminal, more electrophilic end of the fluoroalkene, with only traces of the regioisomeric adducts being detected. Paleta's group have also complimented the work of Chambers *et al*⁵⁶ concerning radical additions of cyclic polyethers to HFP, and 1,3-dioxolane (**32**) was reported to react predominantly in position 2 (**33a**).

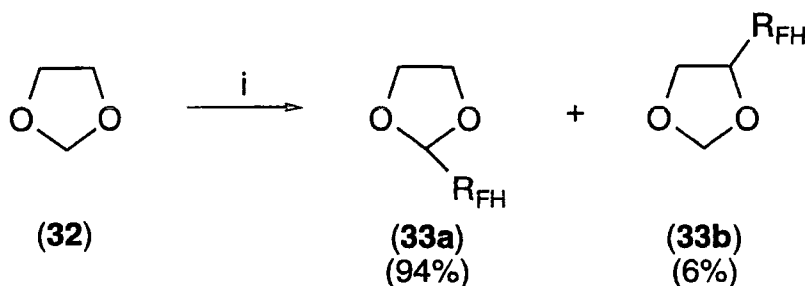

i) HFP, acetone, UV irradiation, room temperature.

ii) $R_{FH} = CF_2CFHCF_3$

Dioxolane (**34**), with a blocked 2-position, reacted selectively at position 4 generating the mono-adduct (**35**) in good yield. This product was deprotected and esterified with methacryloyl chloride to produce monomers that are reported to be used, after polymerisation, for technical and biomedical applications such as contact lenses.³⁶

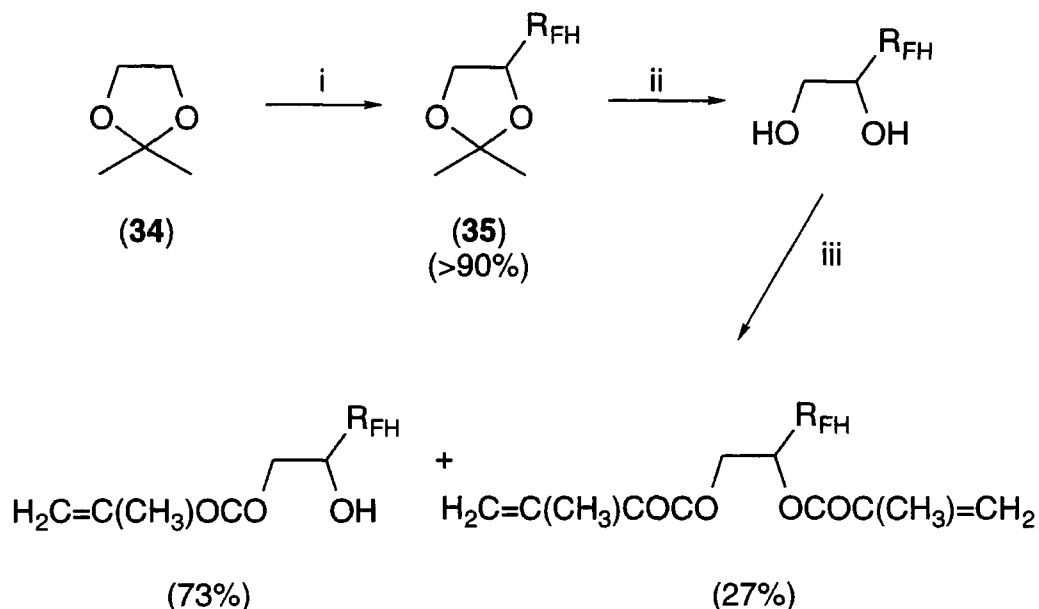

i) HFP, acetone, UV irradiation, room temperature.

ii) H_3O^+

iii) $\text{CH}_2=\text{C}(\text{CH}_3)\text{COCl}$, NH_3 , Et_2O , 0°C .

iv) $\text{R}_{\text{FH}} = \text{CF}_2\text{CFHCF}_3$

This procedure is in contrast to the reported unreactivity of ethane-1,2-diol towards (2) under radical conditions,³⁶ illustrating a difference in reactivity between radicals derived from 1,2-diols and 1,2-diethers which will be further examined in section 4.4.

Multiple additions to cyclic³⁴ and acyclic polyethers have also been documented, and poly-fluoroalkylated mixtures derived from poly-ethylene glycol (PEG) (**36**) have been investigated as co-polymerisation agents with polymethyl methacrylate (PMM).⁶⁵

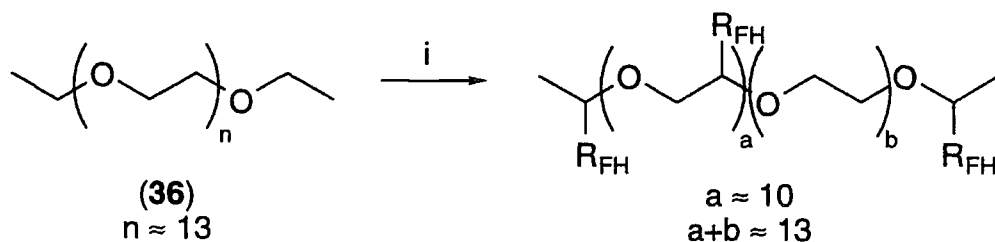

i) HFP, γ -ray or peroxide.

ii) $\text{R}_{\text{FH}} = \text{CF}_2\text{CFHCF}_3$

Furthermore, it is well known that the complexing ability of crown ethers is modified remarkably by the introduction of side-chains,⁶⁶ and interest has thus arisen in the production of polyfluoroalkylated crowns. Chambers⁶³ produced the 18-crown-6 (18-C-6) mono-adduct with HFP under radical conditions.

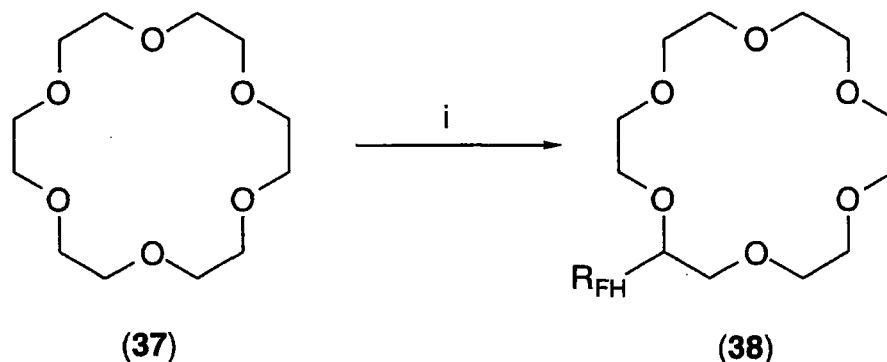

i) HFP, γ -rays or *tert*-butyl peroxide.

ii) $\text{R}_{\text{FH}} = \text{CF}_2\text{CFHCF}_3$

Kirchmeier *et al*⁶⁷ have examined the lanthanum triflate inclusion complex of (38) by X-ray crystallography. The most significant feature of the (18-C-6)-HFP adduct is the long metal-oxygen interaction (2.886 Å) between the lanthanum centre and the oxygen atom nearest the hexafluoropropyl group, in comparison with the unsubstituted polyether (37) (2.681 Å). This reflects the reduced basicity of the heteroatom due to inductive electron withdrawal by the polyfluoroalkyl chain, and the *trans* metal-oxygen interaction is significantly shortened (2.597 Å) as a result.

Shreeve *et al*⁶⁸ have also examined radical additions of cyclic ethers to HFP, and have compared the reactivities of sites adjacent to oxygen and sulphur. Both components of an equimolar mixture of tetrahydrofuran (39) and tetrahydrothiophene (40) add to HFP under peroxide initiation, the yield for the latter being slightly lower than for the former due to decomposition of the thioether.

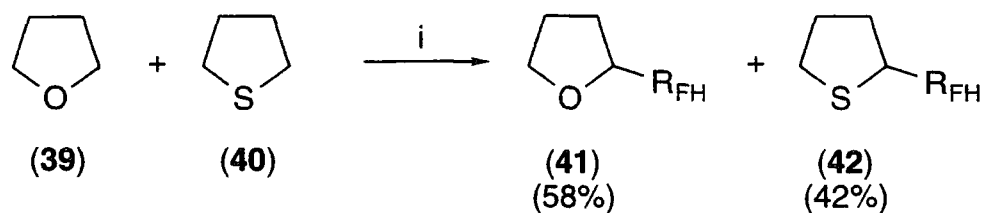

i) HFP, di-*tert*-butyl peroxide, 140°C.

ii) $\text{R}_{\text{FH}} = \text{CF}_2\text{CFHCF}_3$

However, 1,4-thioxane (43) preferentially reacts adjacent to sulphur to generate (44a), the less electronegative heteroatom seemingly being a slightly better donor to an adjacent radical site than is oxygen.

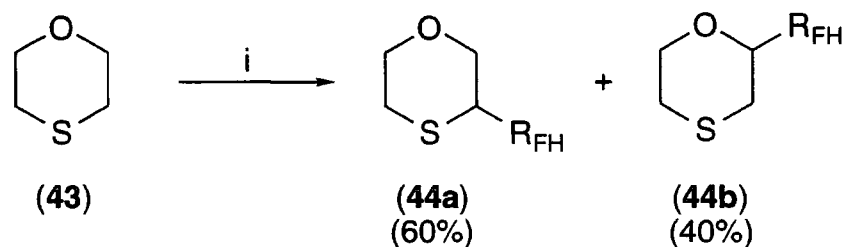

i) HFP, di-*tert*-butyl peroxide, 140°C.

ii) $\text{R}_{\text{FH}} = \text{CF}_2\text{CFHCF}_3$

Finally, both borate⁵⁶ and silyl ethers⁶⁹ readily undergo radical addition to HFP, oxygen lone-pair resonance again increasing the nucleophilicity of the derived radical centres.

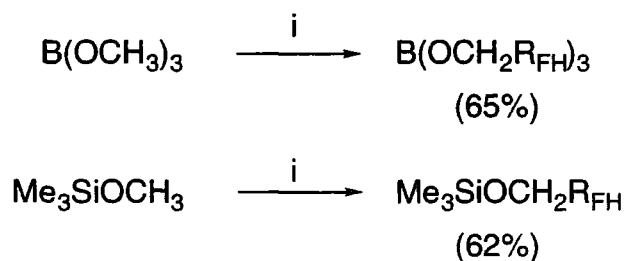

i) HFP, γ -rays, room temperature.

ii) $\text{R}_{\text{FH}} = \text{CF}_2\text{CFHCF}_3$

1.5. Conclusions.

- Fluorine-containing organic compounds have a wide range of uses, and incorporation of fluorine or fluoroalkyl groups into a system can lead to desirable properties.

- Addition of nucleophilic carbon-centred radicals to electrophilic fluoroalkenes is facile and essentially regiospecific due to both electronic and polar effects.

- Work has been documented concerning the radical additions of a number of classes of substrates to fluoroalkenes, yet there are still areas open to investigation including the steric and electronic effects of substituents on the reaction and the relative stabilising properties of ether- and hydroxyl-oxygen atoms.

**Chapter 2: Additions of Cyclic Alcohols to
Hexafluoropropene.**

2.1. Introduction.

Although work has been documented on the radical addition of small acyclic alcohols to HFP,^{35, 70} the analogous reactions of cyclic alcohols have not been well studied, and indeed Lazerte³² *et al* have stated that there is no reaction between cyclohexanol and HFP. Work in this laboratory³⁷ has shown that this is not the case, and cyclic alcohols can be polyfluoroalkylated with HFP under radical conditions in good yields. It is the aim of the current work to further extend the range of the addition process, and to investigate the reactions of substituted cyclic alcohols (chapter 3) and both cyclic and acyclic diols (chapter 4).

2.2. Cyclohexanol.

Cyclohexanol (**45**) reacts with HFP in a quantitative γ -ray initiated process to yield the mono-adduct (**46**) in good yield after purification by column chromatography over silica gel.

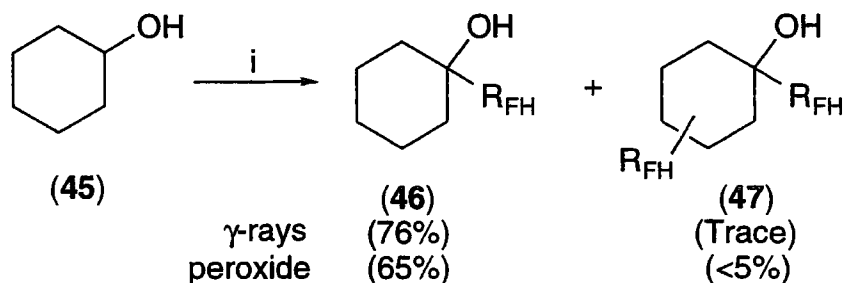

i) HFP, either a) acetone, γ -rays, room temperature, 10 days, or b) di-*tert*-butyl peroxide (5.0%), 140°C, 24 hours.

ii) R_{FH} = CF₂CFHCF₃

Only traces of any di-addition products were detected, and these were removed during purification. Full structure determination of (**46**) was performed using NMR and GC mass spectroscopy, as detailed in sections 2.2.a-b.

Peroxide initiated reaction of cyclohexanol with HFP gave only a slightly lower yield of (**46**), and site-selective incorporation of the polyfluoroalkyl group was again achieved. Up to 5% of a mixture of di-adducts was obtained, but the structures of these species have not been precisely established due to their low yield and the complexity of the spectra. Production of such di-adducts is a consequence of the increased temperature of the peroxide initiated reaction over the γ -ray initiated process, with an associated slight decrease in selectivity.

2.2.a. Orientation of Addition.

In principle, radical addition to HFP (2) can produce two isomeric products, (48) and (49).

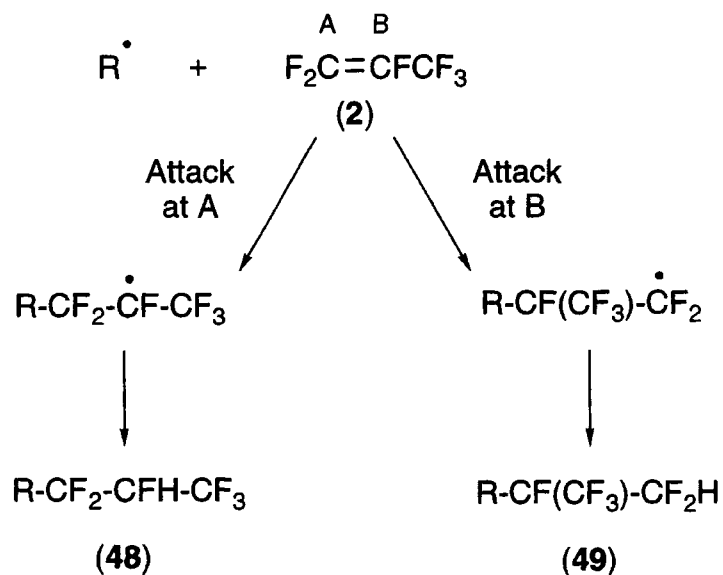

However, the orientation of radical additions to HFP is well established (section 1.3.d.),² and attack occurs predominantly at the more electrophilic difluoromethylene site (A), except in cases where the attacking radical is particularly electrophilic itself. It has been emphasised (section 1.3.c.) that carbon-centred radicals derived from alcohols are rendered quite *nucleophilic* by the adjacent hydroxyl functionality, and thus only products arising from attack at the terminal site were generated.

¹⁹F and ¹H NMR are the most convenient tools for practically confirming which mode of attack is predominant,⁷¹ but certain principles need to be established before the spectra are interpreted. Table 2.2.a.i., overleaf, contains some typical NMR coupling values.⁷²

Interaction ^a .	Coupling Notation.	Typical Values. (Hz)
H-C-F	$^2J_{HF}$	35-65
H-C-C-F	$^3J_{HF}$	0-45 (highest when <i>gauche</i>)
C-F	$^1J_{CF}$	160-370
C-C-F	$^2J_{CF}$	20-50
C-C-C-F	$^3J_{CF}$	0-25 (highest when <i>gauche</i>)
C-C-C-C-F	$^4J_{CF}$	1-5
F-C-F	$^2J_{FF}$	150-280
F-C-C-F	$^3J_{FF}$	0-40 (highest when <i>gauche</i>)

Table 2.2.a.i. Typical H-F, C-F and F-F coupling constants.

a) All bonds being saturated.

Note that in three-bond couplings the highest values occur when the two atoms are *gauche* to one another, as predicted by the Karplus equation.⁷³ 3J Vicinal coupling constants are dependent on the dihedral angle between the two interacting nuclei, and this coupling varies from an intermediate value when the dihedral angle is 0° down to a minimum when the angle is 90° and back up to a maximum when the angle is 180° .

The atoms in the side chain are labelled as follows for convenience:

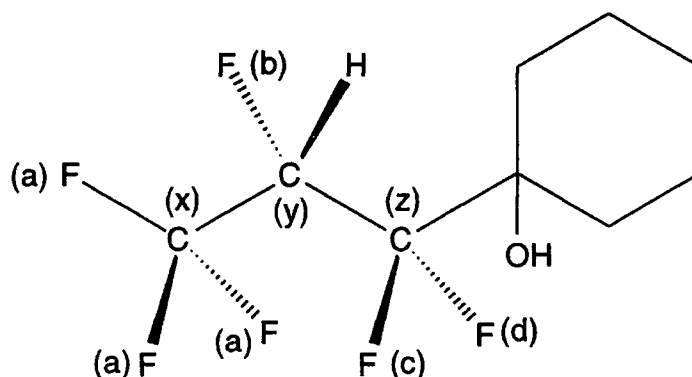

Structure 2.2.a.i. Labelling scheme for the hexafluoropropyl group in (46).

The ^{19}F NMR spectrum of the cyclohexanol mono-adduct (46) consists of three groups of signals, which can be integrated in a 3:2:1 ratio. A multiplet (relative intensity 3) occurs centred at ca. -74 ppm, and this chemical shift value is usual for a trifluoromethyl group adjacent to a saturated site, i.e. F(a). An AB quartet (relative intensity 2) occurs in the region between -125 and -130 ppm, having a J_{AB} coupling value of ca. 270 Hz. This value is typical of a $^2J_{FF}$ coupling and the signal suggests a difluoromethylene group, in which the two atoms are magnetically *inequivalent*

(diastereotopic) and interact strongly with one another, i.e. F(c) and F(d). Finally, a doublet of multiplets (relative intensity 1) occurs at ca. -208 ppm, having a $^2J_{FH}$ coupling in the region of 50 Hz, this being characteristic of a fluorine atom in a fluoromethylene group, i.e. F(b).

Had the alternate mode of radical attack occurred, and given rise to the $-CF(CF_3)CF_2H$ moiety, both the tertiary fluorine atom and the difluoromethyl group in the product would be expected to give resonances between -140 and -190 ppm in the ^{19}F NMR spectrum. No such signals are observed to the limits of the NMR experiment, and this provides conclusive proof that the radical addition of cyclohexanol to HFP occurs at the terminal end of the fluoroalkene, producing the $-CF_2CFHCF_3$ group exclusively.

The 1H NMR signals for (46) occur in two distinct areas of the spectrum. Complex multiplets lie between 1.0 and 2.5ppm, arising from hydrogen nuclei in ring methylene environments, but it is difficult to calculate coupling values due to their complexity. The resonance for the hydrogen atom in the hexafluoropropyl group lies in the region 5.0-6.0 ppm, and appears as in spectrum 2.2.a.i.

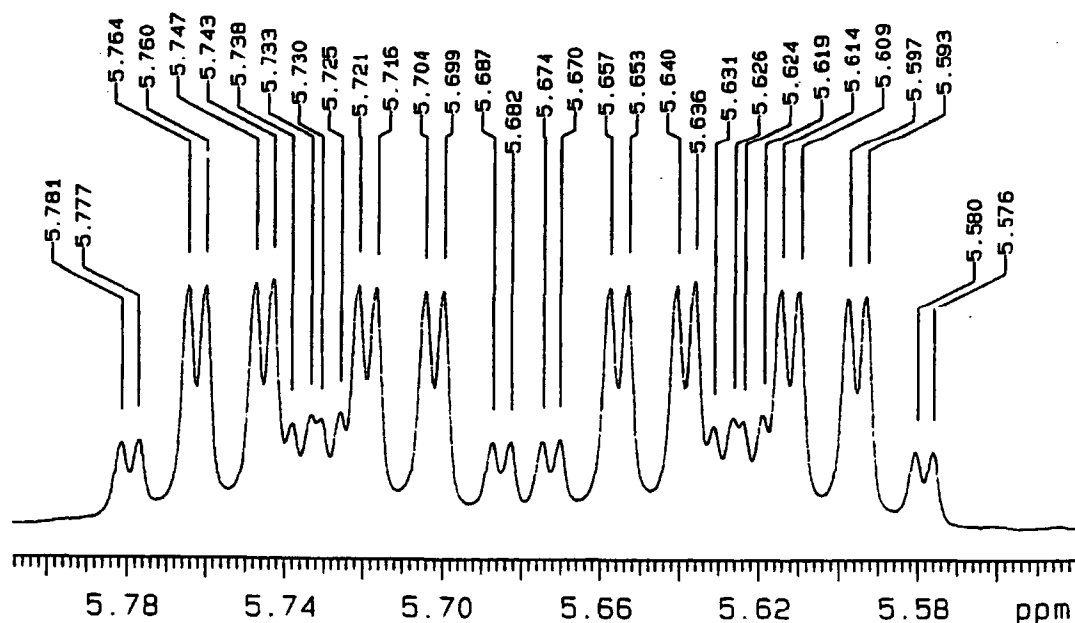

Spectrum 2.2.a.i. 1H NMR signal arising from the hexafluoropropyl (CF_2CFHCF_3) hydrogen atom.

The fluoromethylene hydrogen atom couples with all the nearby fluorine nuclei in the molecule, and the doublet of doublets of quartets of doublets above is rationalised by the presence of one relatively large two-bond coupling and three smaller three-bond couplings. This multiplet again confirms the orientation of addition; had the isomeric

-CF(CF₃)CF₂H group been formed a large ²J *triplet* interaction would be expected in the ¹H NMR spectrum.

Applying the Karplus postulate, the two different H-F coupling constants to the two fluorine atoms of the difluoromethylene system can be rationalised, with the *gauche* interaction being larger than the *syn* interaction. Table 2.2.a.ii. shows the values obtained for (46), using the labelling scheme in 2.2.a.i.

Coupling.	Notation (Multiplicity).	Value. (Hz)
H-F(a)	³ J _{HF} (quartet)	6.8
H-F(b)	² J _{HF} (doublet)	42.8
H-F(c)	³ J _{HF} (doublet)	1.6
H-F(d)	³ J _{HF} (doublet)	17.2

Table 2.2.a.ii. H-F coupling constants for (46).

2.2.b. Site of Addition in Cyclohexanol.

Whilst ¹⁹F and ¹H NMR prove the orientation of addition of cyclohexanol to HFP, ¹³C NMR is required to determine the site at which reaction occurs.

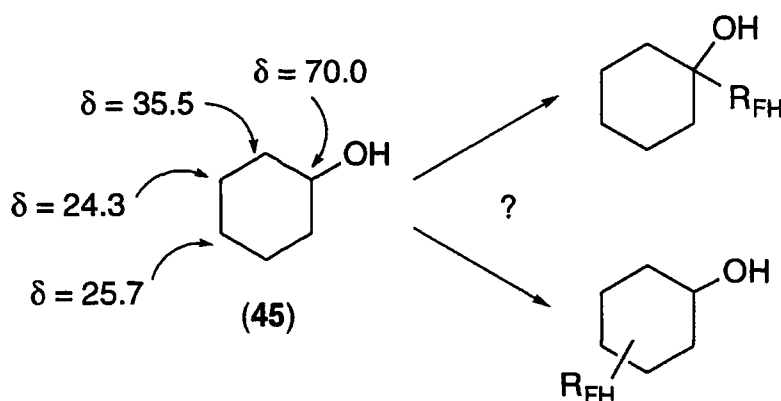

i) δ values in ppm, CDCl₃ solution, R_{FH} = CF₂CFHCF₃

¹³C chemical shifts of the unsubstituted ring sites in cyclohexanol (45) occur in the region 20-45 ppm,⁷⁴ whereas the resonance for the site adjacent to the hydroxyl functionality occurs in the region 60-80 ppm depending on the solvent. Changes in chemical shift accompanying the introduction of a polyfluoroalkyl group are much smaller than this difference, and this is illustrated by the fact that the signals for the ring carbon atoms in the cyclohexane-hexafluoropropene adduct (50) *all* occur in the region 20-40 ppm, including that of the substituted centre.⁴³

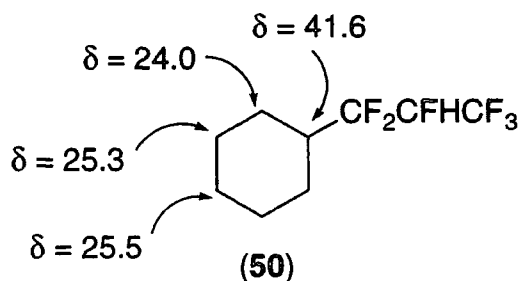

i) δ values in ppm, CDCl_3 solution, $\text{R}_{\text{FH}} = \text{CF}_2\text{CFHCF}_3$

As a consequence the two signals between 70 and 75 ppm observed in the ^{13}C NMR spectrum of (46) can be identified as arising from the *hydroxyl carbon atom* (C1), and these resonances occur as triplets with a $^2J_{\text{CF}}$ coupling of ca. 25 Hz, a 2-bond interaction that indicates addition at this site. An interesting observation, however, is that cyclohexanol (45) shows 4 ring carbon signals in its ^{13}C NMR spectrum, having 2 pairs of equivalent nuclei, whilst the cyclohexanol-hexafluoropropene adduct (46) displays 7 ring carbon resonances, with the hydroxyl carbon contributing two of these signals as mentioned above. Pairs of ring carbon atoms (C2-C6 and C3-C5) in (46) are actually *diastereotopic*, despite their chemical equivalency.

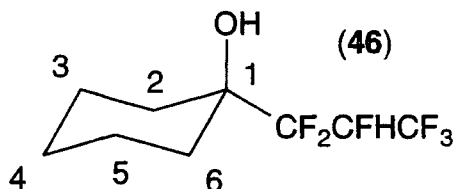

^{13}C NMR Signals given by the carbon atoms in the hexafluoropropyl side-chain are relatively complex, with coupling to the adjacent fluorine nuclei being observed. The fluoromethylene carbon shows a doublet of doublets of quartets of doublets centred at ca. 83.5 ppm, as illustrated in spectrum 2.2.b.i.

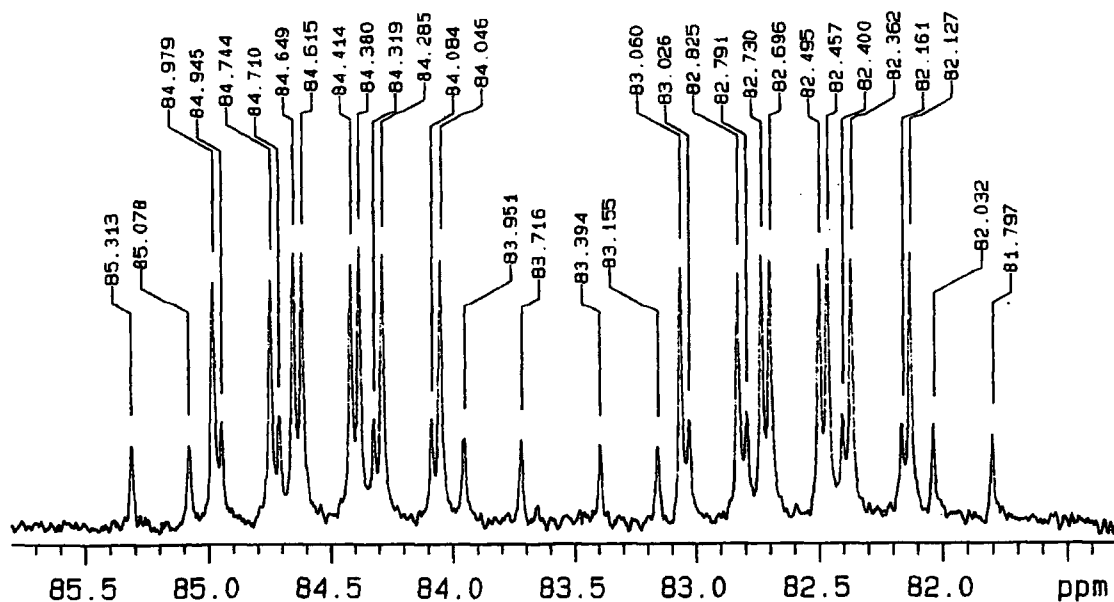

Spectrum 2.2.b.i. ^{13}C NMR signal from the fluoromethylene carbon atom.

This signal is attributable to one relatively large ^1J carbon-fluorine coupling and three smaller ^2J couplings, the two fluorine atoms of the difluoromethylene group being magnetically non-equivalent due to the adjacent stereogenic centre. The signal for both the difluoromethylene carbon, appearing in the region 117-122 ppm as a doublet of doublets of doublets, and the trifluoromethyl group, appearing in the region 118-127 ppm as a quartet of doublets, as both illustrated in spectrum 2.2.b.ii., can also be assigned.

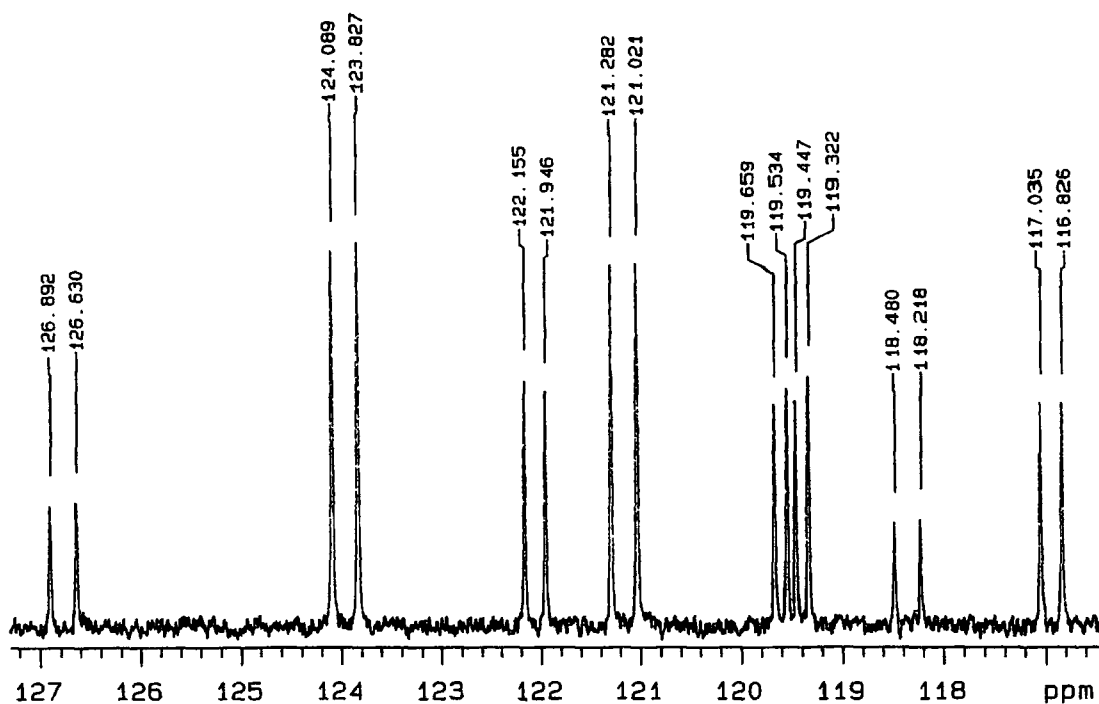

Spectrum 2.2.b.ii. ^{13}C NMR signals from the difluoromethylene and trifluoromethyl carbon atoms.

Table 2.2.b.iii summarises the ^{13}C - ^{19}F coupling constants obtained for (46), again using structure 2.2.a.i.

Coupling.	Notation (Multiplicity).	Value. (Hz)
C(x)-F(a)	$^1J_{\text{CF}}$ (quartet)	282
C(x)-F(b)	$^2J_{\text{CF}}$ (doublet)	26.4
C(y)-F(a)	$^2J_{\text{CF}}$ (quartet)	33.6
C(y)-F(b)	$^1J_{\text{CF}}$ (doublet)	193
C(y)-F(c)	$^2J_{\text{CF}}$ (doublet)	37.0
C(y)-F(d)	$^2J_{\text{CF}}$ (doublet)	23.6
C(z)-F(b)	$^2J_{\text{CF}}$ (doublet)	21.0
C(z)-F(c)	$^1J_{\text{CF}}$ (doublet)	264
C(z)-F(d)	$^1J_{\text{CF}}$ (doublet)	251

Table 2.2.b.iii. C-F coupling constants for (46).

2.2.c. Mass Spectrometry of (46).

NMR is a powerful analytical tool when studying isolated products. GCMS, in comparison, is of great use when examining components of mixtures, and comparison of the spectra of minor radical addition products to the mass spectrum of (46) can be used to derive structural information relating to the component in question.

GCMS experiments run on (46) utilised electron impact (EI) ionisation, and structural features which are able to stabilise a positive charge following ionisation will tend to increase the molecular ion abundance. Alternatively, if a low activation energy decomposition pathway is available, the molecular ion may fragment completely before leaving the ion source and reaching the detector. For (46), the latter case applies and no significant peak at m/z 250 is observed.



Spectrum 2.2.c.iii. Mass spectrum of (46).

Loss of the polyfluorinated side chain from the molecular ion is the dominant pathway, and the 1-hydroxycyclohexyl ion thus formed, $[M-R_{FH}]^+$, has a m/z ratio of 99. Further fragmentation of this daughter species generates the peak at a m/z ratio of 81, a hydrogen atom shift during this elimination resulting in the radical resting in an allylic position.

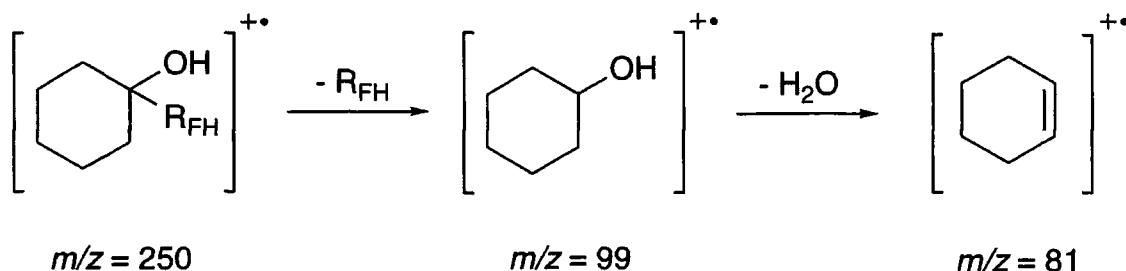

i) $R_{FH} = CF_2CFHCF_3$

This decomposition of the molecular ion also occurs leaving the charge on the hexafluoropropyl group, and it is this ion which gives rise to the small peak at a m/z ratio of 151. Alternatively, rupturing of the carbon-oxygen bond in the molecular ion results in a $[M-OH]^+$ species with a m/z ratio of 233, and this loses hydrogen fluoride to leave an allylic ion with a m/z ratio of 213.

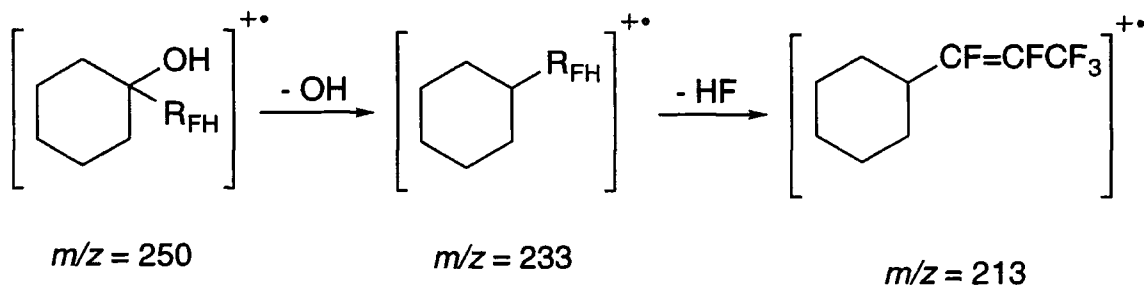

i) $R_{FH} = CF_2CFHCF_3$

2.3. Cyclobutanol, Cyclopentanol and Cycloheptanol.

A range of small-ring carbocyclic alcohols underwent efficient radical addition reactions to HFP under γ -ray initiation.

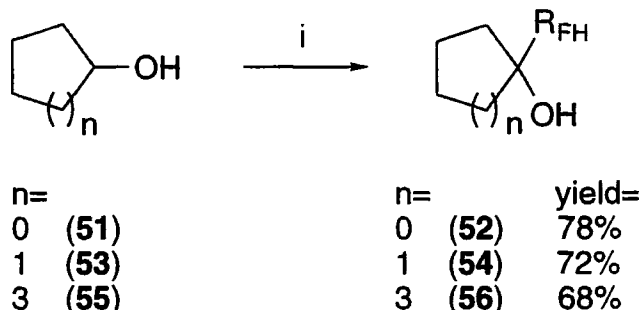

i) HFP, acetone, γ -rays, room temperature, 10 days.

ii) $R_{FH} = CF_2CFHCF_3$

Characterisation of species (52), (54) and (56) was performed in a manner analogous to that described in section 2.2.a-c., and in all three cases the radical addition proceeded selectively between the hydroxyl site and the terminal difluoromethene group. Only traces of di-addition species were detected.

Further use of some of the above alcohols, however, is almost prohibited by their cost: cyclobutanol and cycloheptanol are relatively expensive. However, cyclopentanol reacted in an analogous manner to cyclohexanol under di-*tert*-butyl peroxide initiation to give the mono-adduct (54).

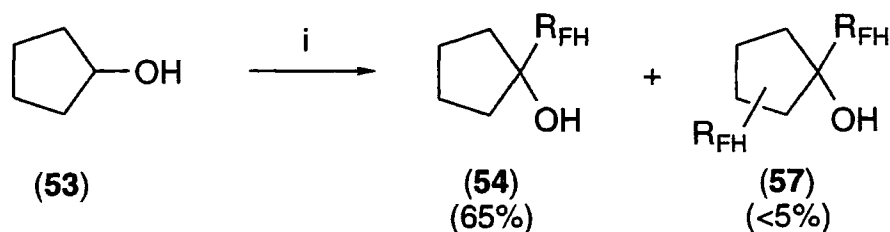

i) HFP, di-*tert*-butyl peroxide (5.0%), 140°C, 24 hours.

ii) $R_{FH} = CF_2CFHCF_3$

Small amounts of di-adducts were detected by GCMS and ^{19}F NMR but not isolated.

2.3.a. Competition Between Cyclopentanol and Cyclopentane.

Radical reactions are extremely sensitive to inhibition, and even traces of impurities such as oxygen can alter markedly the reaction conversion.⁸ This high sensitivity explains why yields for a particular process often vary from experiment to experiment, and only when two species are reacted simultaneously in the same vessel can their relative reactivities be meaningfully compared. Despite the limitations of this technique, to demonstrate the effect of the hydroxyl oxygen atom on the radical addition rate a competition reaction between cyclopentane and cyclopentanol was performed using a deficiency of fluoroalkene.

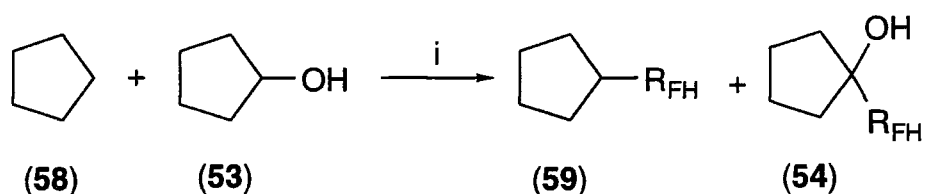

i) HFP, acetone, γ -rays, room temperature, 10 days.

ii) $R_{FH} = CF_2CFHCF_3$

Species	Composition Prior to Reaction ^a (%)	Composition After Reaction ^a (%)	Conversion (%)	Statistically Corrected Conversion (%)
<chem>C1CCCC1</chem> (58)	35.74	27.89	21.96	2.20
<chem>C1CCC(O)C1</chem> (53)	64.26	47.47	26.13	26.13

Table 2.3.a.i. Competition reaction results.

a) Using GC ratios and incorporating response factors.

Clearly there is little difference in the *overall* reactivity between the two species (58) and (53). However, the single tertiary site in (53) is approximately an order of magnitude more reactive than *each* individual secondary site in (58), which in turn are many times more reactive than the remaining methylene sites in (53). This confirms that the oxygen atom renders the radical derived from (53) more nucleophilic, and hence more reactive to HFP, than that derived from (58), whilst also deactivating the adjacent methylene groups (section 1.4.a.).

2.3.b. Competition Between Cyclopentanol, Cyclohexanol and Cycloheptanol.

To investigate whether altering the carbocyclic ring size, and hence varying the angle strain around the developing radical intermediate, affects the overall rate of reaction, a mixture of alcohols (53, 45 and 55) was irradiated with a deficiency of HFP.

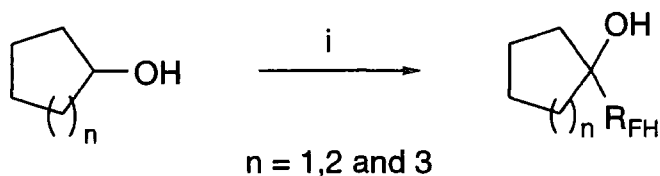

i) HFP, acetone, γ -rays, room temperature, 10 days.

ii) RFH = $\text{CF}_2\text{CFHCF}_3$

Species	Composition Prior to Reaction ^a (%)	Composition After Reaction ^a (%)	Conversion (%)
 (53)	29.26	22.77	22.18
 (45)	36.51	28.98	20.62
 (55)	34.23	27.26	20.36

Table 2.3.b.ii. Competition reaction results.

a) Using GC ratios and incorporating response factors.

There is little difference in reactivity along the series, and it may be concluded that the size of the carbocyclic ring, and hence small differences in the magnitude of the bond angles around the tertiary site, have relatively little effect on the overall reactivity of the radical centre.

2.4. Cyclooctanol, Cyclodecanol and Cyclododecanol.

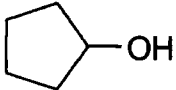
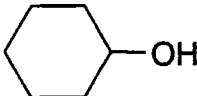
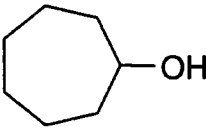
Cyclooctanol (**60**) gave a different product distribution to that of the smaller carbocyclic alcohols when irradiated with γ -rays together with HFP under analogous conditions. The major component of the product mixture was an isomeric combination of di-adducts.

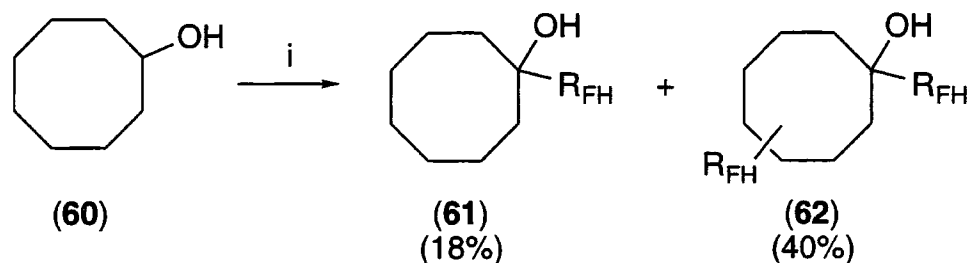

i) HFP, acetone, γ -rays, room temperature, 10 days.

ii) $R_{FH} = CF_2CFHCF_3$

The relatively large amount of di-adduct species (**62**) obtained in the reaction can be rationalised by a combination of two effects. Firstly, there are methylene sites in the carbocyclic ring sufficiently distant from the deactivating alcohol functionality discussed in section 1.4.a. to enable hydrogen atom abstraction to occur. Secondly, the cyclooctyl ring is sufficiently flexible to permit a 'back-biting' process, and the electrophilic radical formed by the initial addition to HFP may be able to abstract a hydrogen atom *intramolecularly* from one of the aforementioned methylene groups.

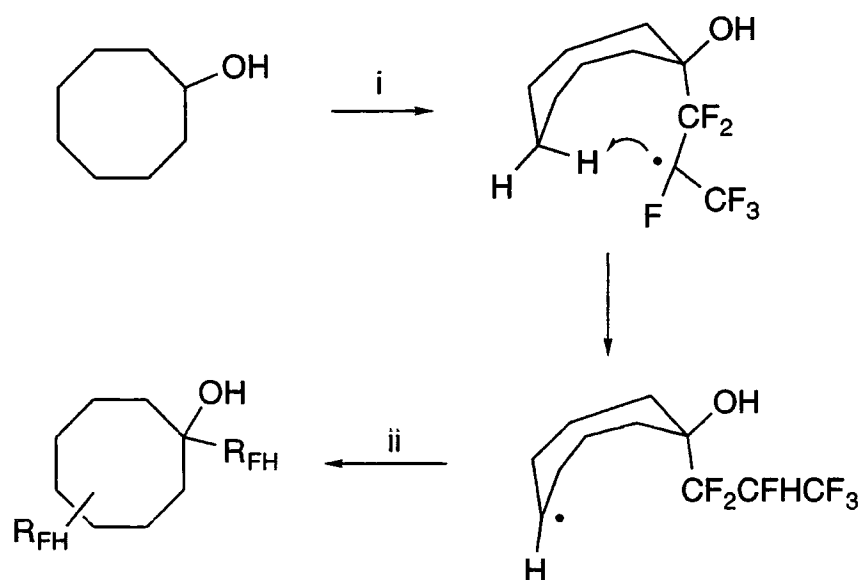

i) γ -rays, HFP.

ii) HFP, chain transfer.

iii) $R_{FH} = CF_2CFHCF_3$

However, if a mixture of the mono- and di-adducts (ratio ca. 1:3) is irradiated with a further quantity of HFP the overall conversion to the di-adduct is increased (ratio ca. 1:8), confirming that a stepwise intermolecular di-addition process is also in evidence and that (62) can be formed from (61). The data obtained for the many di-adducts (62) were highly complex, but the mixture as a whole gave satisfactory mass spectra.

In contrast, cyclodecanol (63) and cyclododecanol (65) both reacted poorly with HFP under γ -ray irradiation, and overall conversions of less than 10% were observed, with residual fluoroalkene being recovered.

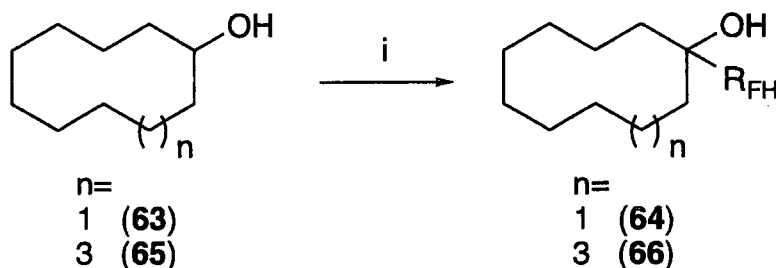

- i) HFP, acetone, γ -rays, room temperature, 10 days.
 ii) $R_{FH} = CF_2CFHCF_3$

The presence of the mono-adducts (64) and (66) was detected in each case by GCMS, and their mass spectra obtained, but the reactions are less selective towards mono-addition and many di-adducts were generated. Clearly, the factors discussed above affecting the addition of cyclooctanol to HFP are even more pronounced in the cases of the larger carbocyclic alcohols, and the poor selectivity is unsurprising. The low conversions, however, can be partly attributed to the relative insolubility of cyclodecanol and cyclododecanol in acetone, implying that only low contact between the reagents is obtained.

Peroxide initiated reaction of (63) with HFP afforded a complex mixture of many mono- and di-adducts (19% and 7% respectively by GC), with reaction occurring preferentially but not exclusively at the hydroxyl site, as determined by ^{19}F NMR and GCMS. Alcohol conversion was much higher (ca. 50%) than in the γ -ray initiated analogue, as the peroxide decomposition temperature is above the melting point of (63) and reagent contact is improved, but site-selectivity is still poor and no individual products were isolated.

2.5. Conclusions.

- Small carbocyclic alcohols react well with HFP under both γ -ray and peroxide initiation.
- The addition proceeds selectively at the hydroxyl site in the alcohol and only attack at the terminal difluoromethyl group of the fluoroalkene bond is observed.
- Larger cyclic alcohols give higher adducts due to both the increased ring flexibility and the presence of methylene sites sufficiently active to undergo hydrogen atom abstraction.
- Competition reactions illustrate both the increased reactivity of radicals derived from alcohols over those derived from alkanes and the tolerance of the radical addition process towards varying ring size.

**Chapter 3: Additions of Cyclohexanol Derivatives
to Hexafluoropropene.**

3.1. Introduction.

The aim of this chapter is to determine the effects of alkyl substituents on the stereochemical course of the radical addition process, and hence the reactions of a range of cyclohexanol derivatives with HFP were examined. Some of these alcohols, however, are relatively insoluble in acetone, and a more polar solvent was first required in order to increase the reaction conversions.

3.2. Alternative Reaction Media.

Acetone is a good medium for the γ -ray initiated addition process in that it is unreactive towards HFP under radical conditions. Trifluoroethanol, however, is more polar and a better solvent. Furthermore, this alcohol is reported to be unreactive to HFP at room temperature,³² as radicals derived from trifluoroethanol are rendered electrophilic by the adjacent trifluoromethyl group (section 1.3.1.) and thus react poorly with electrophilic fluoroalkenes. To investigate this polar effect, a previously successful reaction was repeated using trifluoroethanol in order to examine its potential as a reaction medium.

Cyclohexanol (45) reacted with HFP in trifluoroethanol to give the mono-adduct (46) as before, with no polyfluoroalkylation of the solvent being detected by either GCMS or NMR.

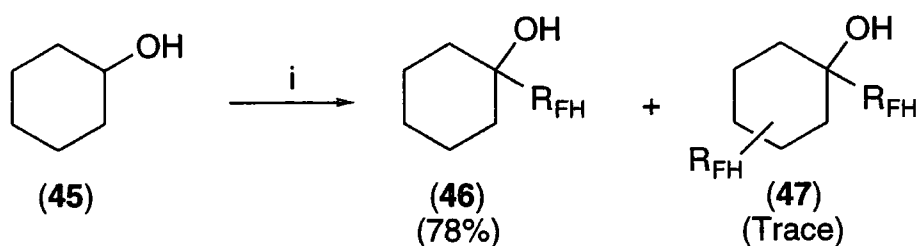

i) HFP, trifluoroethanol, γ -rays, room temperature, 10 days.

ii) R_{FH} = CF₂CFHCF₃

Potential drawbacks to the use of trifluoroethanol are its higher price and toxicity compared to acetone, but careful use and recovery of the reaction solvent, followed by re-distillation, decreased these factors effectively.

3.3. *Cis* and *Trans* 4-Methylcyclohexanols.

Trans-4-methylcyclohexanol (**67**) reacted with HFP under γ -ray initiation to yield two isomeric mono-addition products (**68a**, **68b**) in good yield, and this result is in agreement with previous observations.³⁷ A small amount of a di-adduct was detected by both GCMS and NMR and subsequently isolated.

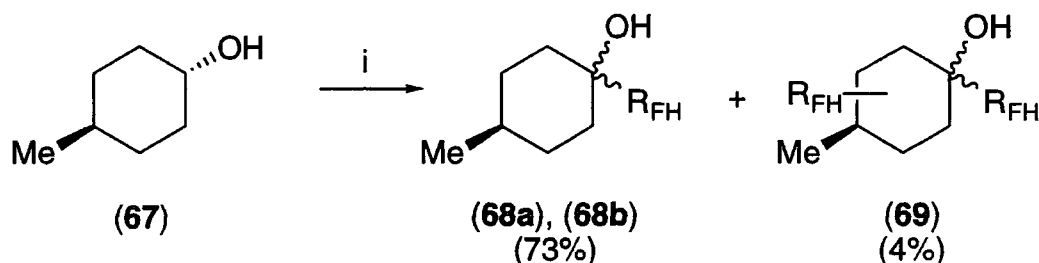

i) HFP acetone, γ -rays, room temperature, 10 days.

ii) R_{FH} = CF₂CFHCF₃

The ratio of the two mono-addition products was approx. 10:1 as determined by GCMS and ¹⁹F NMR, and clearly the methyl group, despite being distant from the reaction centre, induces a degree of stereocontrol on the addition process. *Cis* 4-methylcyclohexanol reacted under analogous conditions to give the *same two mono-adduct products in the same 10:1 ratio*, determined as above.

Obtaining identical products from both reactions implies that the two radical additions proceed via a common intermediate.⁸ Indeed, if a *planar* radical is formed at the hydroxyl site, and if it is sufficiently persistent to allow the carbon skeleton to ring-flip prior to addition, the *cis* and *trans* alcohols may form identical radical intermediates.

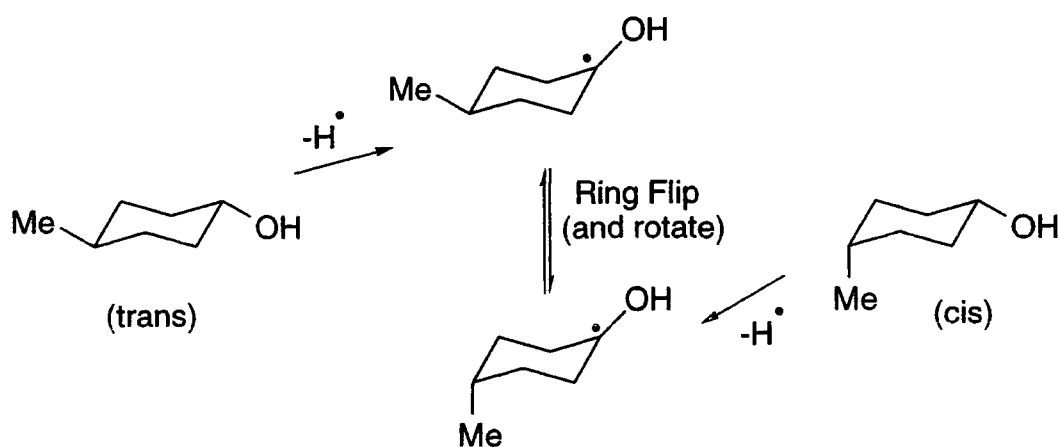

Two factors may explain the stereocontrol of the reaction. Firstly, the bulky fluoroalkene will preferentially approach the radical centre in an equatorial orientation, the axial mode of attack being sterically disfavoured. Secondly, the most stable methylcyclohexanol radical is that in which the methyl group *also* occupies an equatorial position, and from a combination of these two effects (**68a**) is the predicted major product.

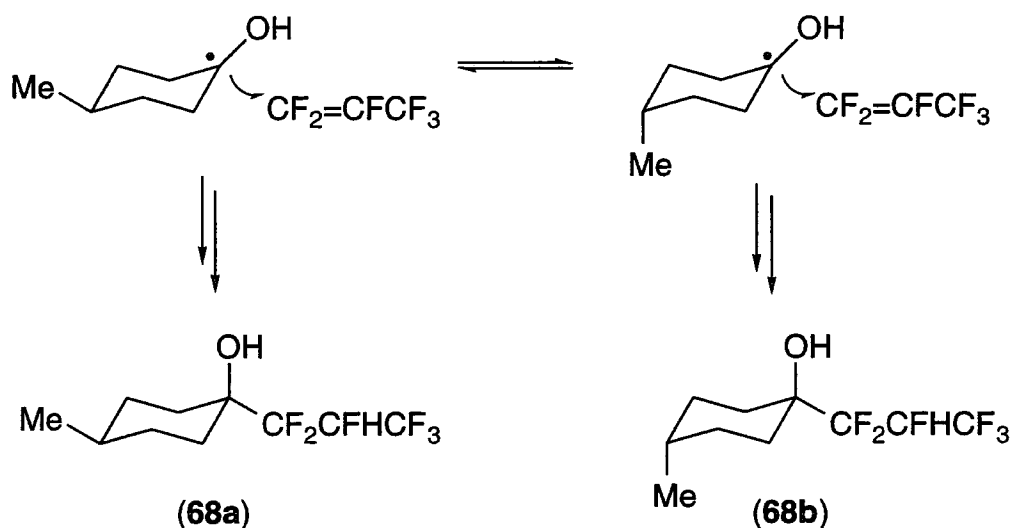

NMR data provides evidence for this postulate, although absolute proof of the stereochemistry is difficult using the data available. *Trans*-4-methylcyclohexanol (**67**) exists in a di-equatorial configuration, and the chemical shift of the axial tertiary hydrogen atom adjacent to the methyl group, identified by 2-dimensional ^1H - ^1H Correlated Spectroscopy (COSY) NMR, is 1.25 ppm. (Complex multiplet in Spectrum 3.3.i.)

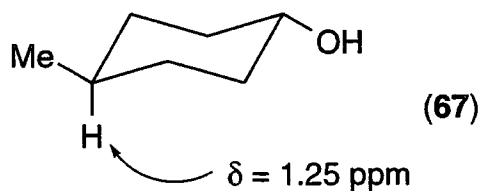

Resonances for the remaining *axial* hydrogen atoms in (**67**) occur in the region 0.8 to 1.2ppm, whilst the *equatorial* hydrogen atoms give rise to signals between 1.6 and 1.9ppm.

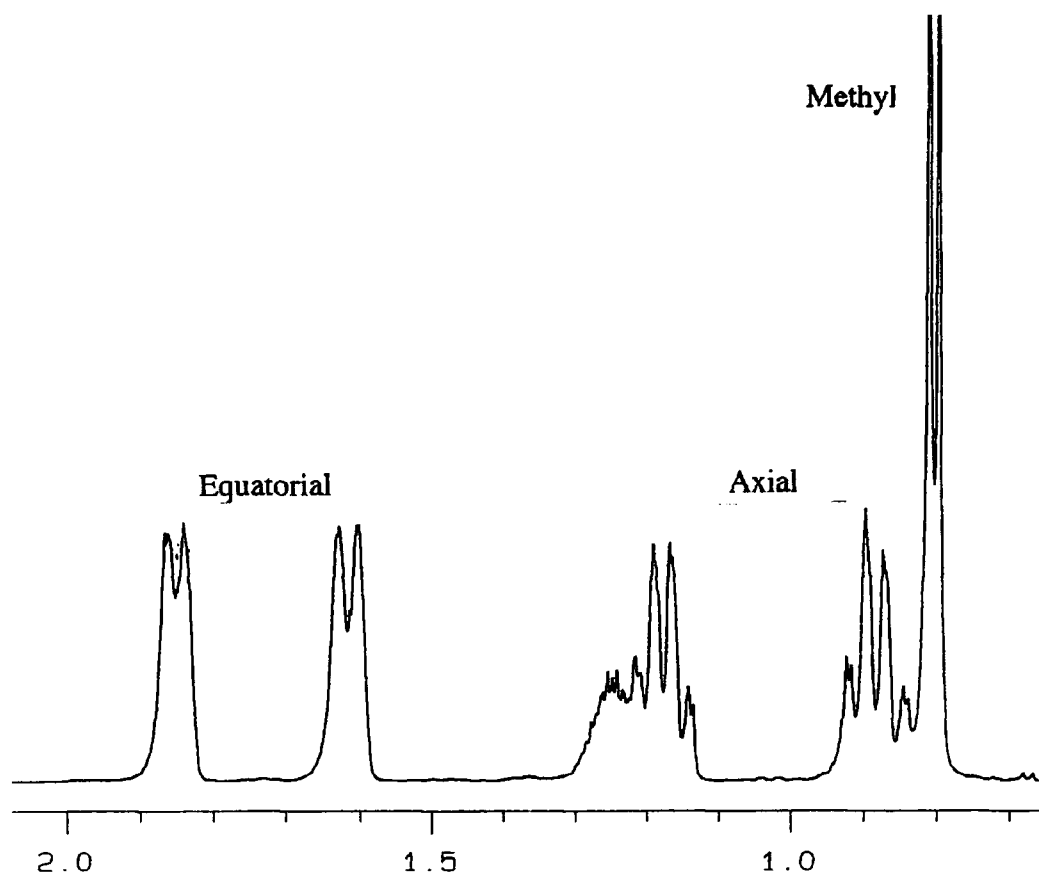

Spectrum 3.3.i. ^1H NMR spectrum of 4-methylcyclohexanol (**67**) (500 MHz).

The tertiary hydrogen atom in the major mono-adduct has a chemical shift of 1.30ppm, again determined by ^1H - ^1H COSY NMR, and this value implies that this isomer also exists with the hydrogen atom in an *axial* position (**68a**).

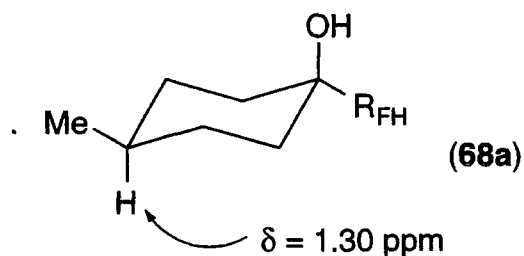

The di-adduct component of the reaction product crystallised upon standing, and recrystallisation from ethanol yielded the 1,4-di-addition product (**69**) in very low yield (4%). A single crystal of this minor component was examined by X-ray crystallography and consisted of 8 symmetrically dissimilar species, detailed in the experimental section.

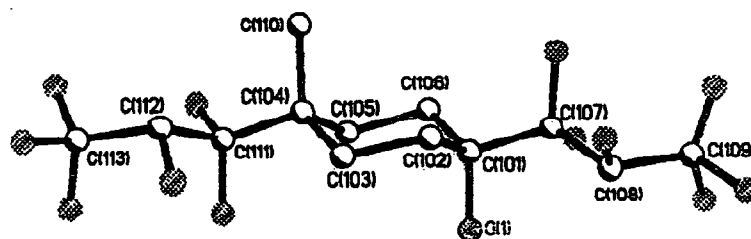

Structure 3.3.i. 1,4-Di-(1,1,2,3,3,3-hexafluoropropyl)-4-methylcyclohexanol.

The large number of crystallographically unique structures is due to the fluoromethylene stereogenic centre in each polyfluoroalkyl group and the prochiral centres in the carbocyclic ring (section 2.2.b.). Noticably, however, *each* of the 8 structures shows the cyclohexyl ring to be adopting a chair configuration with the hexafluoropropyl substituents both occupying *equatorial* positions. The methyl and hydroxyl groups are hence forced into axial environments, and only species arising from addition at the two tertiary sites were detected by the experiment, reflecting the reduced BDE of tertiary C-H bonds over secondary.

3.4. 4-Tert-Butylcyclohexanol.

To investigate further the stereochemical control induced by ring substituents, 4-*tert*-butylcyclohexanol (**70**) was reacted with HFP under γ -ray initiation in trifluoroethanol. The *tert*-butyl substituent is considered to be a 'conformational lock' in small ring carbocyclic systems, yet two isomeric mono-addition products were again obtained, in a ratio of approx. 10:1 as determined by GC and ^{19}F NMR.

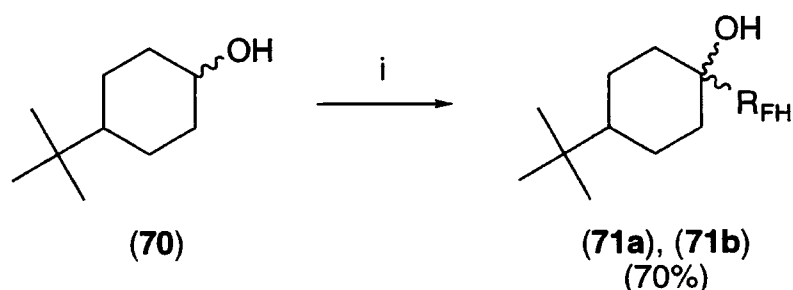

- i) HFP, trifluoroethanol, γ -rays, room temperature, 10 days.
- ii) $\text{R}_{\text{FH}} = \text{CF}_2\text{CFHCF}_3$

This result implies that ring-flipping of the radical intermediate, prohibited by the *tert*-butyl group in this system, is not the predominant factor in the generation of geometrically isomeric species. Approach of the fluoroalkene from either side of the radical centre must hence be the major consideration.

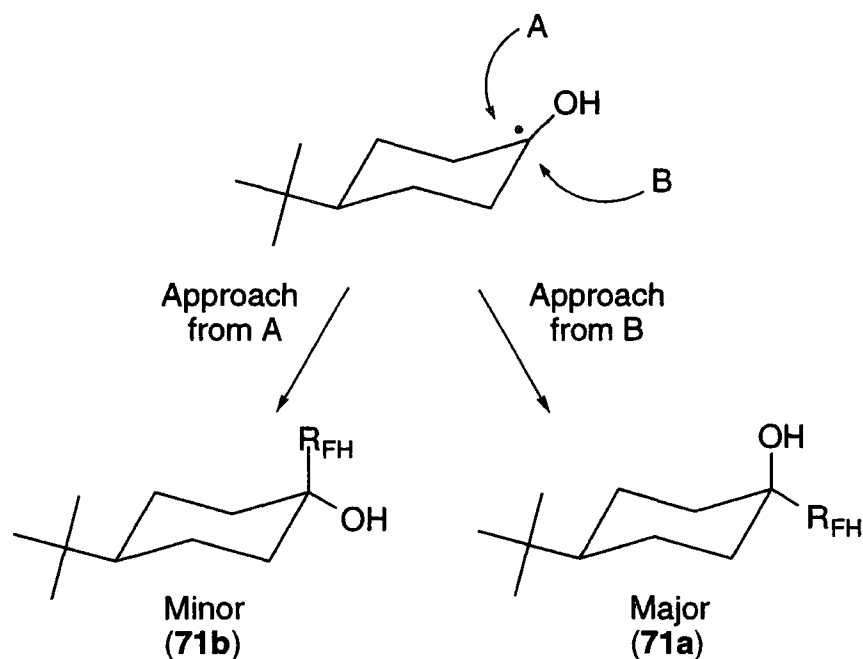

i) $R_{FH} = CF_2CFHCF_3$

The major mono-adduct isomer (**71a**) was recrystallised from ethanol and a single crystal was studied by X-ray crystallography. Three crystallographically dissimilar species were detected, reflecting both the fluoromethylene chiral centre and some disorder in the crystal lattice.

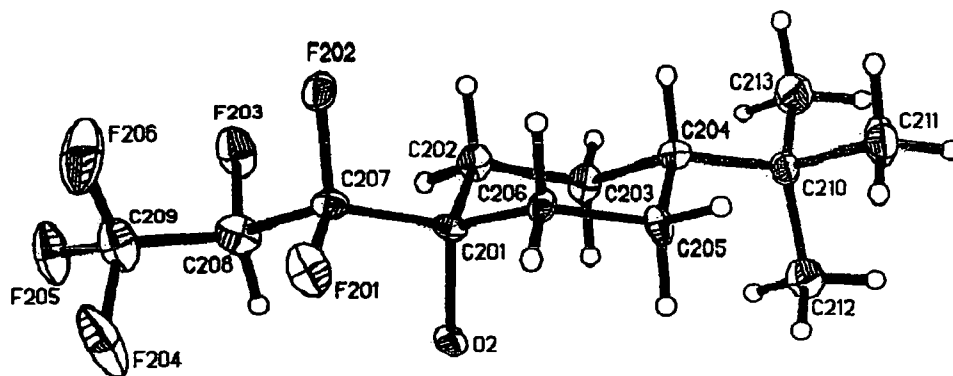

Structure 3.4.i. 1-(1,1,2,3,3,3-Hexafluoropropyl)-4-*tert*-butylcyclohexanol. (S-Isomer.)

Each of the structures show the *tert*-butyl and hexafluoropropyl substituents to be occupying *equatorial* positions, confirming that pathway B, above, is predominant. The tertiary ring hydrogen atom is clearly being forced into an axial environment, and the 1H NMR chemical shift of this nucleus is 1.05ppm. This low chemical shift value provides further evidence that the analogous hydrogen atom in the methyl substituted cyclohexanol adduct (**68a**) is *also* axial, with the alkyl group equatorial as discussed.

3.5. Trans-2-Methylcyclohexanol.

Incorporating even a relatively small substituent close to the radical addition site in cyclohexanol has a profound effect on the reaction rate. *Trans*-2-methylcyclohexanol (**72**) reacted with HFP under γ -ray initiation in low conversion (ca. 35%) to give one major product, the reduced reactivity reflecting the higher steric demand around the hydroxyl centre. Surprisingly, the product was identified by GCMS as being a di-addition compound, with the $[M-H_2O]^+$ and $[M-R_{FH}]^+$ ions clearly visible at m/z 396 and 263 respectively.

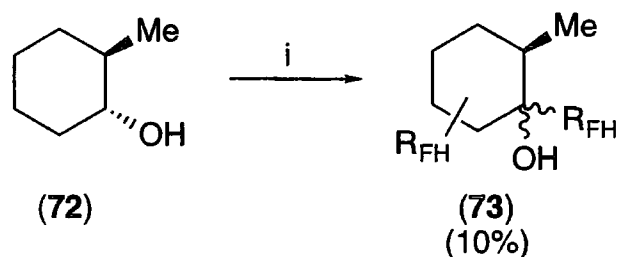

i) HFP, acetone, γ -rays, room temperature, 10 days.

ii) $R_{FH} = CF_2CFHCF_3$

NMR data confirms the incorporation of two polyfluoroalkyl groups, the ^{19}F spectrum showing two groups of signals in equal intensity. Of these resonances, the AB quartets arising from the difluoromethylene groups give the most structural information, these nuclei being closest to the reaction centres. One AB system occurs centred at ca. -120 ppm, this value being typical of a difluoromethylene moiety adjacent to hydroxyl (section 2.2.a). The second ^{19}F AB quartet is centred at ca. -108 ppm, and this chemical shift, when compared with the value of the difluoromethylene group in the *isobutane*-HFP adduct⁴³ (**74**), implies substitution at a *primary* carbon centre.

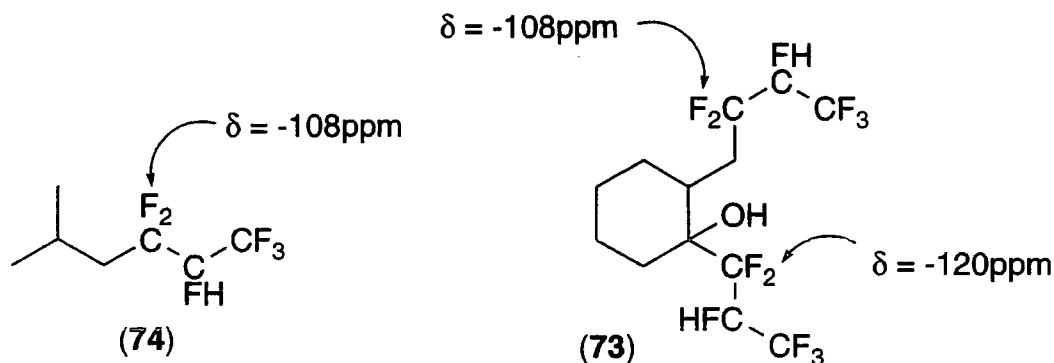

Distortionless Enhancement by Polarisation Transfer (DEPT) NMR is a technique that allows a ^{13}C spectrum to be resolved into its primary-, secondary-, tertiary-, and quaternary-carbon constituents, and DEPT experiments on (73) confirm that no methyl group resonance is displayed by the di-adduct. This selective functionalisation of a primary site, considered to be relatively unreactive towards hydrogen atom abstraction in comparison with secondary and tertiary centres²⁷ is unusual, and the reaction is likely to proceed by an intramolecular 'back-biting' radical cascade mechanism.⁷⁵

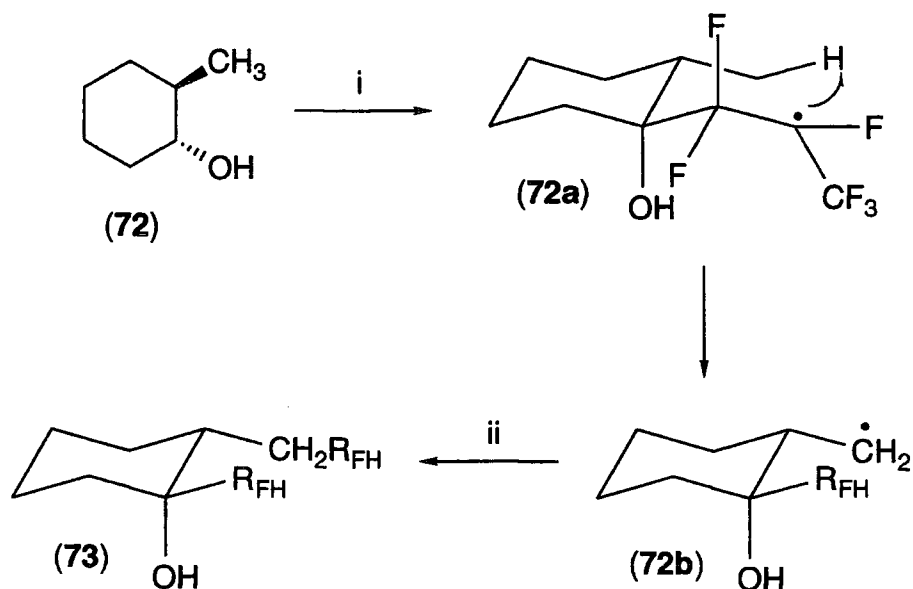

i) γ -rays, HFP.

ii) HFP, chain transfer.

iii) $\text{R}_{\text{FH}} = \text{CF}_2\text{CFHCF}_3$

Assuming that the initial hydrogen atom abstraction occurs adjacent to the hydroxyl group, with the consequent addition of this radical to HFP, the marked preference for bulky substituents to occupy equatorial positions in carbocyclic systems ensures that the developing fluoroalkyl radical centre (72a) is held near the adjacent methyl group. The *intramolecular* six-membered hydrogen atom abstraction is kinetically favoured over intermolecular chain transfer, despite the higher carbon-hydrogen BDE in the methyl group, and the primary alkyl radical (72b) is thus generated. Addition of this species to a second fluoroalkene molecule is followed by chain transfer to yield the di-adduct (73).

The cascade mechanism outlined above bears a remarkable similarity to the Barton reaction,⁷⁶ which also concerns radical functionalisation of a methyl site. Synthesis of the steroid aldosterone is readily achieved using Barton methodology.

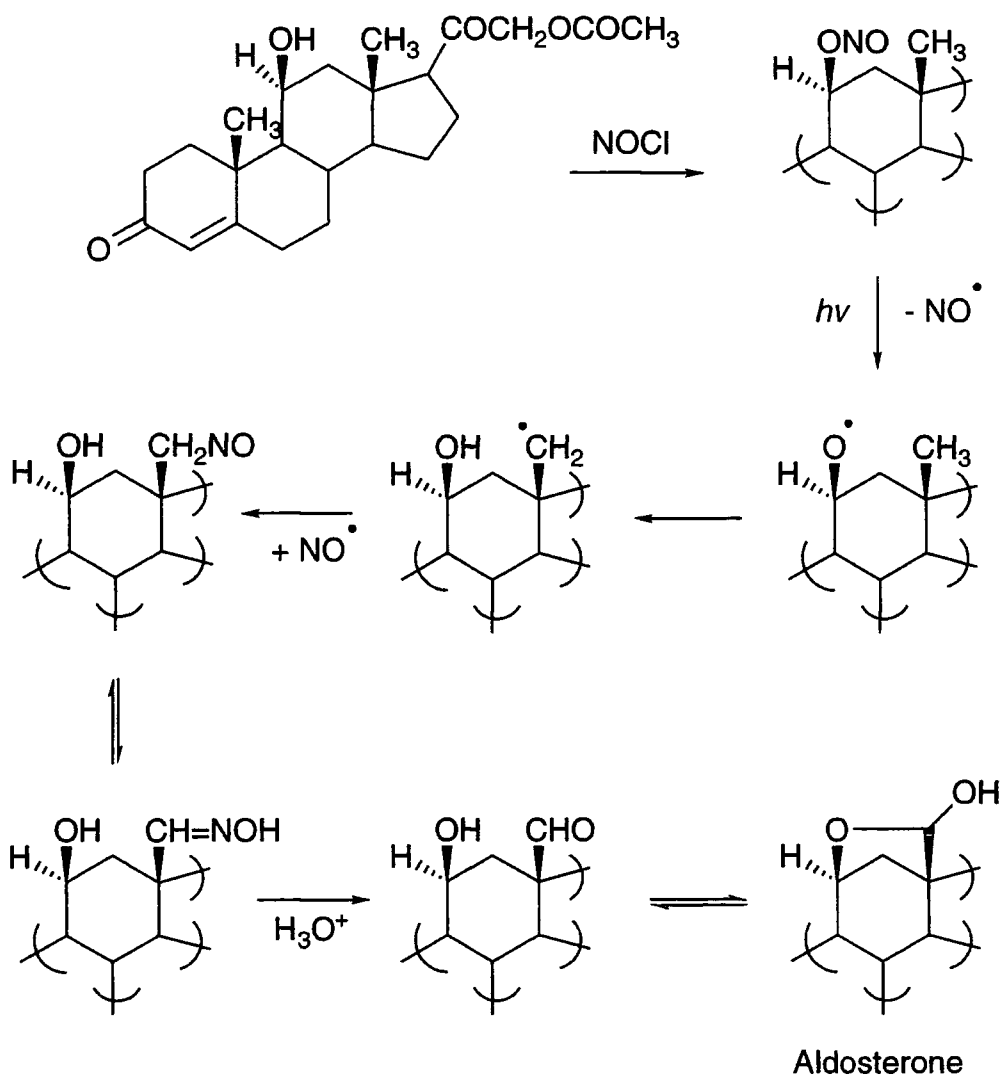

The Barton reaction is facilitated by the rigidity of the carbon skeleton and the 1,3-diaxial relationship of the hydroxy and methyl functionalities, and the key step involves an electrophilic oxygen-centred radical abstracting a hydrogen atom *intramolecularly* from a nearby methyl group. Reaction of 2-methylcyclohexanol (72) with HFP involves a carbon-centred radical behaving in an analogous manner.

Peroxide initiated reaction of (72) with HFP gave the same di-adduct in similar yield (14%). However, the overall conversion of HFP was greater and numerous trace products were detected by GCMS. These could not be isolated but reflect the increased temperature and associated decreased selectivity of the peroxide initiated reaction over the γ -ray analogue.

3.6. Iso-Menthol.

In order to extend the site-selective polyfluoroalkylation of alcohols to naturally occurring systems, including simple terpenoids, a mixture of *iso*-menthol (**75**) and HFP was irradiated with γ -rays.

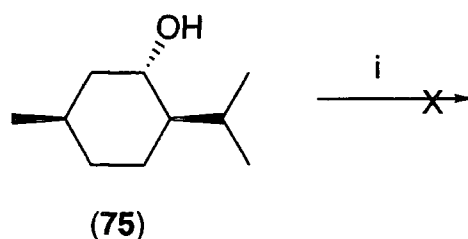

i) HFP, either a) acetone, γ -rays, room temperature, 10 days, or b) di-*tert*-butyl peroxide, 140 °C, 24 hours.

No reaction occurred, and the starting materials were recovered. This low reactivity, when considering the large decrease in conversion associated with the incorporation of a *methyl* group at the 2-position in cyclohexanol (section 3.5.), is perhaps unsurprising. The analogous peroxide initiated reaction was similarly unsuccessful, and the reagents were again recovered. Clearly, increased steric demand around the alcohol centre completely inhibits the reaction progress at this site, whilst the oxygen atom continues to inductively deactivate the other carbon centres (section 1.4.a.).

3.7. Exo-norborneol.

Having demonstrated that the presence of even small exocyclic substituents adjacent to the hydroxyl centre inhibits the radical addition to HFP, *exo*-norborneol (**76**) was reacted under γ -ray initiation to give the mono-adduct (**77**) as the major product. The steric influence of the bridging methylene unit is relatively small in comparison with that of a pendant substituent, and the isolated yield after the usual irradiation period was only slightly lower than in the cases of the monocyclic alcohols.

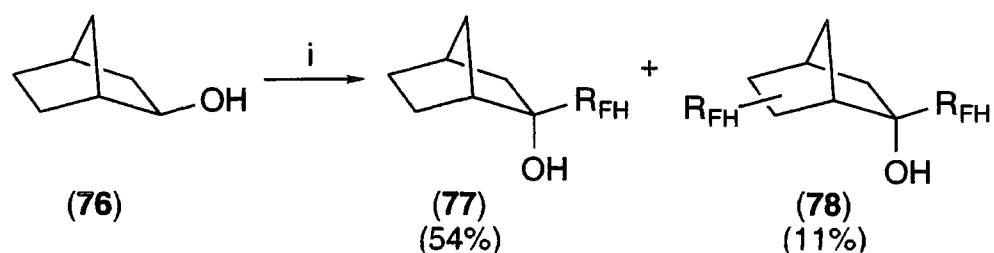

i) HFP, acetone, γ -rays, room temperature, 10 days.

ii) $R_{FH} = CF_2CFHCF_3$

Mono-adduct **(77)** was isolated and found to consist of two isomers, tentatively assigned to being the *exo*- and *endo*-adducts, in a ratio of approx. 20:1 as determined by GC. This high stereoselectivity reflects the steric influence of the carbon skeleton on the addition step, reaction proceeding preferentially at the least hindered face of the bicyclic framework giving the *exo*-polyfluoroalkylated product.

Significant amounts of di-adducts were identified by GCMS, but the NMR spectra of these were complex and DEPT experiments imply that the second hexafluoropropyl group is incorporated at more than one site in **(77)**. If a mixture of **(77)** and **(78)** (ratio ca. 5:1) is irradiated together with HFP the overall incorporation of HFP is increased (ratio of products ca. 3:1) and this confirms that the di-adducts can be produced from **(77)** as well as there being the possibility of intramolecular 'back-biting' di-addition directly from **(76)**.

3.7.a. Competition Between Cyclohexanol and Exo-norborneol.

To determine quantitatively the effects of steric hinderance on relative reactivity, a mixture of cyclohexanol (**(45)**) and *exo*-norborneol (**(76)**) was irradiated with a deficiency of HFP.

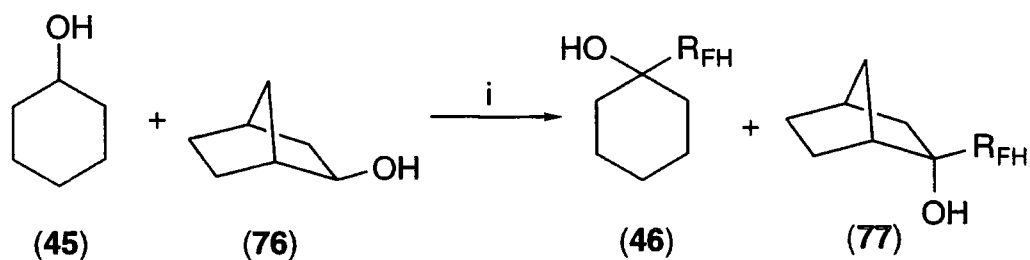

i) HFP, acetone, γ -rays, room temperature, 10 days.

ii) $R_{FH} = CF_2CFHCF_3$



Species	Composition Prior to Reaction ^a (%)	Composition After Reaction ^a (%)	Conversion (%)
 (45)	42.75	16.30	61.87
 (76)	57.25	37.13	35.14

Table 3.7.a.i. Competition between cyclohexanol and *exo*-norborneol.

a) Using GC ratios and incorporating response factors.

Radical addition occurs preferentially at the least hindered centre (i.e. at cyclohexanol), and the relative reactivity is approximately 2:1 in favour of the monocyclic alcohol over the bicyclic species. Increasing steric demand and the increased energy barrier to ring flexation during sp^3 - sp^2 rehybridisation in the norbornane skeleton are clearly reflected in the alcohol conversions.

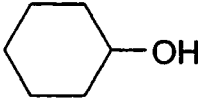
3.8. Decahydronaphthanol.

Cis-decahydronaphthan-1-ol (**78**) reacted poorly with HFP in acetone under γ -ray initiation, with a fluoroalkene conversion of less than 10% after the usual irradiation period of 10 days. No product was isolated, but ^{19}F NMR indicated the presence of a species with *two* distinct hexafluoropropyl groups in a 1:1 ratio. The difluoromethylene AB quartet resonances of these two substituents had different chemical shifts, one of the values (ca. -120 ppm) being typical for substitution adjacent to hydroxyl (section 2.2.a.).

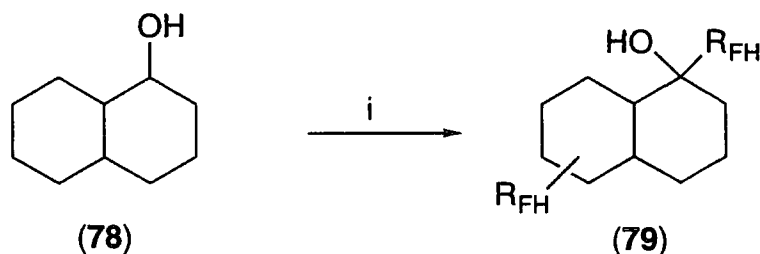

i) HFP, acetone, γ -rays, room temperature, 10 days.

ii) $\text{R}_{\text{FH}} = \text{CF}_2\text{CFHCF}_3$

GCMS experiments also identified the component as being a di-adduct, exhibiting a $[M+H]^+$ ion peak at m/z 455. Given the structural similarity of 2-methylcyclohexanol and decahydronaphthan-1-ol, it is possible that the second polyfluoroalkyl group is incorporated at site 8, *via* an intramolecular 'back-biting' cascade process (section 3.5.).

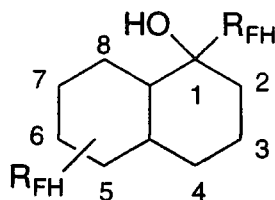

Peroxide initiated reaction of (78) with HFP gave a higher conversion of fluoroalkene (ca. 40%), and a large number of mono- and di-adduct compounds were identified by GCMS. The low selectivity displayed reflects both the increased temperature of the peroxide initiated process and the steric requirements around the hydroxyl site.

A mixture of *cis*- and *trans*-decahydronaphthan-2-ol (80), reacted with HFP under γ -ray initiation in moderate conversion (ca. 45%) to give a mixture of mono- and di-adduct isomers (81), identified by GCMS.

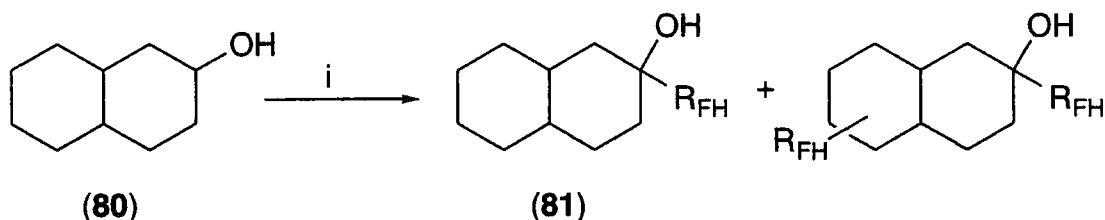

i) HFP, acetone, γ -rays, room temperature, 10 days.

ii) $R_{FH} = CF_2CFHCF_3$

Each mono-adduct isomer displays a clear $[M-H_2O]^+$ ion at m/z 286 in the mass spectrum, but the ^{19}F NMR spectrum was complex and no product was isolated. Such polycyclic alcohols are, however, good models for larger steroidal systems, and the addition to decahydronaphthan-2-ol implies that functionalisation of complex natural systems is plausible using this methodology.

3.9. 3 β -Cholesterol.

To avoid substituents other than hydroxyl affecting the radical addition pathway, 3 β -cholestanol (82) was chosen to investigate polyfluoroalkylation of steroids. However, this complex alcohol is sparingly soluble in both acetone and

trifluoroethanol, and only trace conversions to a mono-adduct (**83**) were detected after γ -ray irradiation with HFP. The peroxide initiated reaction of (**82**) gave a similar low conversion, the high melting point of the steroid inhibiting reaction. Furthermore, the molecular size and number of potential reaction sites in the substrate effectively reduce the reaction selectivity and no product could be isolated.

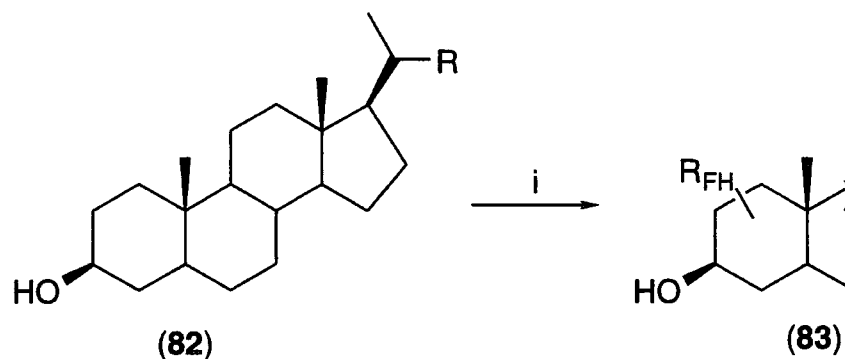

- i) HFP, either a) acetone or trifluoroethanol, γ -rays, room temperature, 10 days, or b) di-*tert*-butyl peroxide (5.0%), 140 °C, 24 hours.
 ii) $R_{FH} = CF_2CFHCF_3$

The molecular size, high melting point and low solubility of the steroid also prevented gas chromatography experiments, and crude ^{19}F NMR gave the only indication that any radical addition had occurred.

3.10. Conclusions.

- Both small and large substituents at the 4-position in cyclohexanol induce stereocontrol on the radical addition to HFP, with the hexafluoropropyl group preferentially occupying an equatorial site.
- Small alkyl substituents at the 2-position sterically inhibit the reaction, but *intramolecular* functionalisation of the substituent can occur by a cascade process. Larger substituents adjacent to hydroxyl dramatically reduce the reactivity of the site.
- Larger alcohols display reduced reactivities and selectivities, due to a combination of steric and solubility effects.

**Chapter 4: Additions of Polyoxygenated Compounds
to Hexafluoropropene
and Additions of Cyclic Alcohols to Cyclic
Perfluoroalkenes.**

4.1. Introduction.

Having investigated steric influences on the radical addition of cyclohexanol derivatives to fluoroalkenes (chapter 3), we were prompted to consider electronic effects. It has been emphasised that whilst carbon-centred radicals adjacent to oxygen are stabilised by resonance with the heteroatom lone pairs (section 1.3.a.), inductive electron withdrawal disfavours radical formation at other positions. Radicals derived from *diols* are thus conjugatively activated by one hydroxyl unit and inductively deactivated by the other, and the latter effect is clearly dependent upon the bond spacings involved.⁶³ Hence, cyclic and acyclic polyols were reacted with HFP, and furthermore the reactivities of secondary and tertiary hydroxyl-stabilised radical sites were compared. In addition, the radical additions of a number of hydroxy-ethers were examined in order to investigate the relative reactivities of the hydroxy- and ether-stabilised centres. Finally, reactions of methanol and ethanol to perfluorocyclobutene⁶¹ and perfluorocyclopentene^{77, 78} have been previously documented, and this area of chemistry was extended to encompass both cyclic alcohols and perfluorocyclohexene.

4.2. Cyclic Polyols.

4.2.a. Cyclohexanediols.

An equimolar mixture of *cis* and *trans* cyclohexane-1,4-diol (**84**) reacted quantitatively with two equivalents of HFP under γ -ray initiation to give the 1,4-diadduct (**85**) in good isolated yield, and this is in agreement with previous observations.³⁷

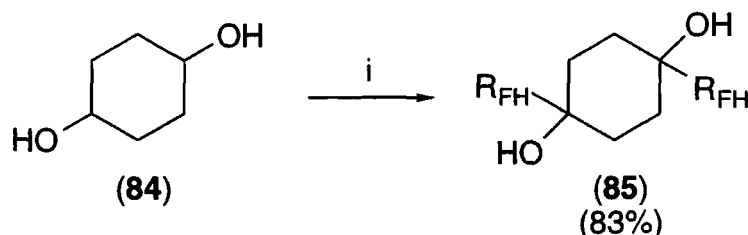

i) 2HFP, acetone, γ -rays, room temperature, 10 days.

ii) $R_{FH} = CF_2CFHCF_3$

The second hydroxyl group will decrease the *nucleophilicity* of the radical derived from (**84**), the electronegativity of oxygen inductively reducing the electron density of the radical site. Furthermore, the second hydroxyl group will similarly inhibit *chain transfer* as the electronegativity of oxygen will also reduce the electron density of the tertiary C-H bond in (**84**). However, no mono-addition compounds were isolated, and it

is clear that the inductive deactivation of a 4-hydroxyl group on the radical derived from (84) is small in comparison with the lone-pair resonance stabilisation of oxygen, due to the bond spacing involved.

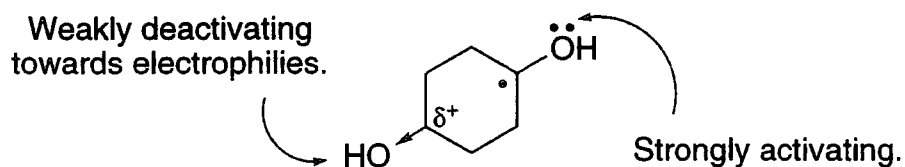

In comparison, an equimolar mixture of *cis* and *trans* cyclohexane-1,3-diol (86) reacted with two equivalents of HFP under analogous conditions to give a mixture of mono- and di-adducts, with fluoroalkene being recovered (ca. 15%).

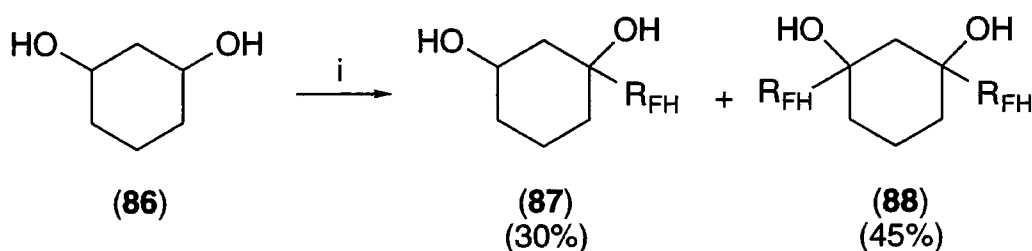

- i) 2HFP, acetone, γ -rays, room temperature, 10 days.
 ii) $R_{FH} = CF_2CFHCF_3$

Moving the second hydroxyl group closer to the radical site reduces the reaction conversion, possibly due in part to the increased steric demand of the *trans* isomer.

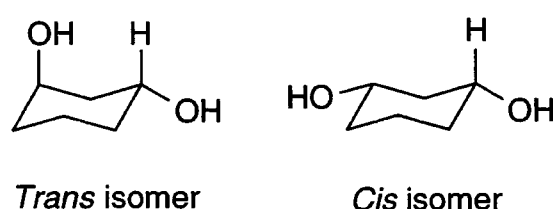

However, the inductive electron withdrawal of hydroxyl on the radical site is greater in magnitude due to the reduced bond spacing, and decreases both the stability and the nucleophilicity of the radical centre.

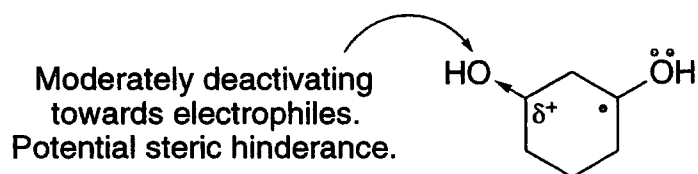

Finally, *trans* cyclohexane-1,2-diol (**89**) was irradiated with two equivalents of HFP but no reaction occurred and the starting materials were recovered. The analogous peroxide initiated reaction was similarly unsuccessful, with both diol and fluoroalkene again being recovered.

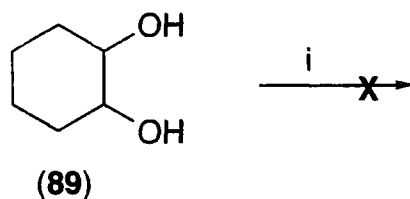

i) 2HFP, either a) acetone, γ -rays, room temperature, 10 days or b) di-*tert*-butyl peroxide (5.0%), 140°C, 24 hours.

The inductive electron withdrawal of the second hydroxyl group on the reaction centre is now at its largest, dramatically reducing nucleophilicity of the radical. Paleta reported a similar reactivity trend in acyclic diol systems,³⁶ with ethane-1,2-diol being unreactive towards HFP whilst butane-1,4-diol was converted to the diadduct in low yield (section 1.4.a.). However, steric demand in the cyclohexane-1,2-diol system is also a factor, and indeed the large drop in conversion associated with incorporation of a methyl substituent at the 2-position in cyclohexanol (section 3.5.) will be similarly in evidence in (**89**), the steric requirements of methyl and hydroxyl being close in magnitude.¹ It is thus likely to be a combination of both electronic and steric effects that renders 1,2-diols unreactive towards HFP under radical conditions.

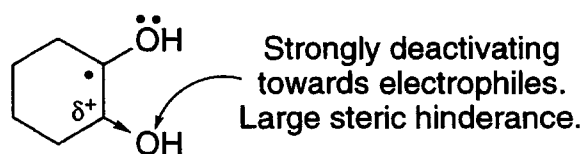

4.2.b. Competition Between Cyclohexane-1,2-diol and Cyclohexane-1,4-diol.

To ensure that no trace impurity is inhibiting the radical reactions of cyclohexane-1,2-diol (**89**), a mixture of (**84**) and (**89**) was irradiated with a deficiency of HFP.

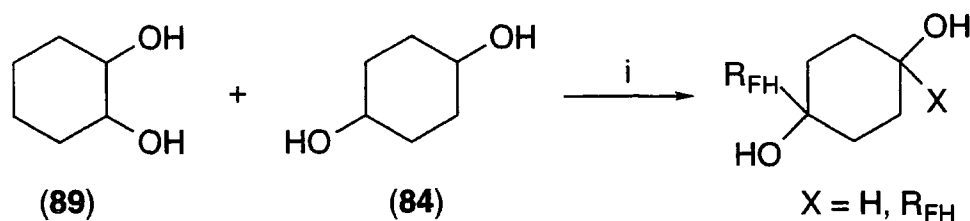

- i) HFP, acetone, γ -rays, room temperature, 10 days.
- ii) R_{FH} = CF₂CFHCF₃

Quantitative conversion of HFP was achieved, and the conversions of the two alcohols were 0% for (**89**) and ca. 43% for (**84**). Both mono- and di-adducts derived from (**84**) were detected, with (**89**) and residual (**84**) being recovered, confirming that there is a large difference in reactivity between the two diols.

4.2.c. Cyclohexane-1,3,5-triol.

Cis-cis-cyclohexane-1,3,5-triol (**90**) was irradiated with three equivalents of HFP but no reaction occurred and the starting materials were recovered.

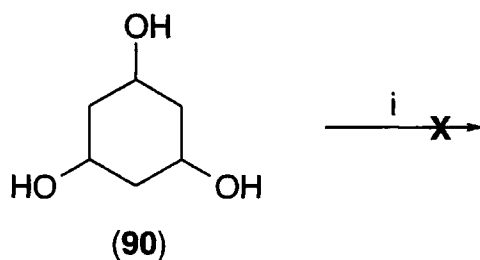

- i) 3HFP, acetone, γ -rays, room temperature, 10 days.

The combined effect of two 3-hydroxyl groups on the radical derived from (**90**) seems to be similar to that of a single 2-hydroxyl unit, inductive electron withdrawal on the radical centre reducing the reaction conversion dramatically. Furthermore, cyclohexane-1,3,5-triol decomposes upon heating, rendering autoclave reactions difficult.

4.2.d. Cyclopentane-1,3-diol.

A mixture of *cis* and *trans* cyclopentane-1,3-diol (**91**) reacted with one equivalent of HFP under γ -ray initiation to give a mixture of mono- and di-adducts (ratio ca. 1:3), and with two equivalents of HFP under either γ -ray or peroxide initiation to give the di-adduct (**92**) exclusively.

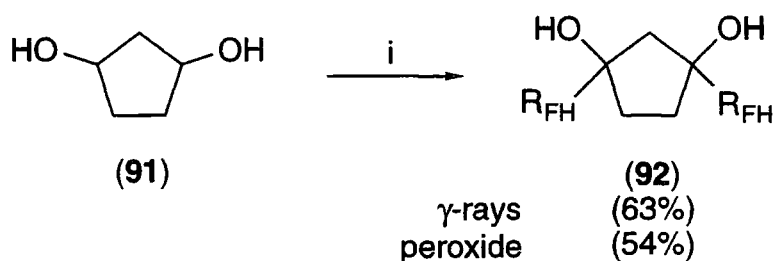

i) 2HFP, either a) acetone, γ -rays, room temperature, 10 days, or b) di-*tert*-butyl peroxide (5.0%), 140°C, 24 hours.

ii) $R_{FH} = CF_2CFHCF_3$

Generation of (**92**) as the major product when a deficiency of fluoroalkene is used implies that 'back-biting' is occurring. Intramolecular hydrogen atom abstraction may proceed *via* a 6-membered transition state and is kinetically favoured over chain transfer.

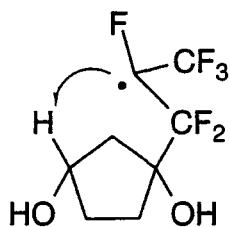

A single crystal of the di-adduct (**92**) was examined by X-ray crystallography, as detailed in the experimental section.

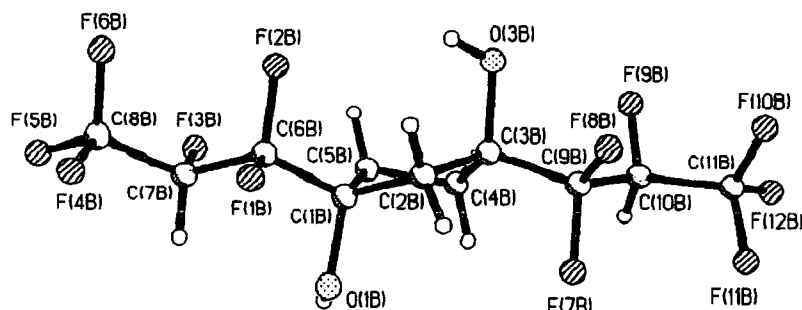

Structure 4.2.d.i. 1,3-Di-(1,1,2,3,3,3-hexafluoropropyl)-cyclopentane-1,3-diol.

The 1,3-hexafluoropropyl substituents, occupying pseudo-equatorial positions, enforce a twisted geometry on the cyclopentane skeleton and force the two axial hydroxyl functionalities onto opposite sides of the ring.

4.3. Acyclic Diols.

Whilst cyclic polyols are useful models to illustrate both inductive and steric effects, acyclic species are conformationally much more flexible and allow the 'back-biting' process mentioned above to be further investigated.

4.3.a. Secondary Acyclic Diols.

Pentane-2,4-diol (**93**) reacted quantitatively with two equivalents of HFP under γ -ray initiation to give the di-adduct (**94**) in good isolated yield.

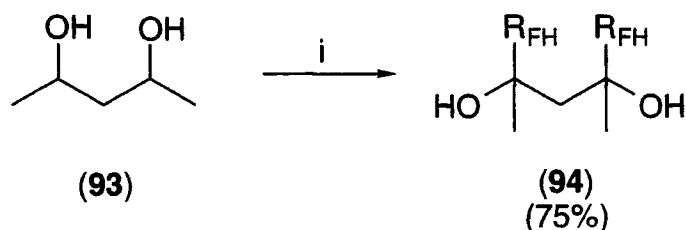

i) 2HFP, acetone, γ -rays, room temperature, 10 days.

ii) $R_{FH} = CF_2CFHCF_3$

Di-addition is predominant, even if a deficiency of fluoroalkene is used, and no mono-adduct products were isolated. This implies that 'back-biting' is again occurring, a process that is likely to be facilitated by the flexibility of the acyclic system (overleaf).

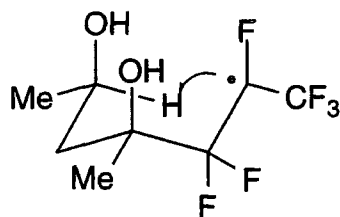

Hexane-2,5-diol (**95**), in comparison, reacted under analogous conditions to give a mixture of mono- and di-adducts (identified by GCMS, ratio approx. 1:4). The mono-adduct could not be separated from the starting material, and only the di-addition product (**97**) could be isolated.

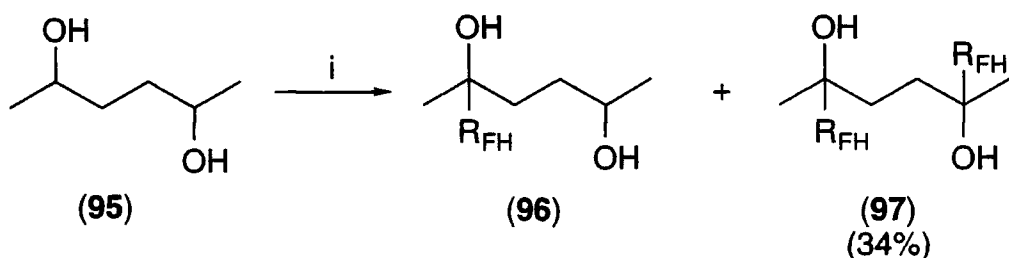

- i) 2HFP, acetone, γ -rays, room temperature, 10 days.
- ii) $R_{FH} = CF_2CFHCF_3$

Residual HFP was recovered (ca. 41%), and production of the mono-adduct indicates that chain transfer now competes with the intramolecular 'back-biting' reaction, which must proceed *via* a seven membered transition state that is disfavoured by Baldwin's rules. The decreased reaction conversion, despite the increased spacing between hydroxyl groups reducing inductive electron withdrawal, illustrates the kinetic acceleration that 'back-biting' can induce. However, yields of (**97**) are improved with increased fluoroalkene concentration, and reaction of (**95**) with five equivalents of HFP gives (**97**) in 73% yield.

4.3.b. Primary Acyclic Diols.

Propane-1,3-diol (**98**) was reacted with two equivalents of HFP under γ -ray initiation, giving both mono- and di-adduct compounds (identified by GCMS, ratio approx. 1:3). Residual fluoroalkene was recovered (ca. 36%), and the mono-adduct again could not be separated from the starting material, only the di-adduct (**100**) being isolated.

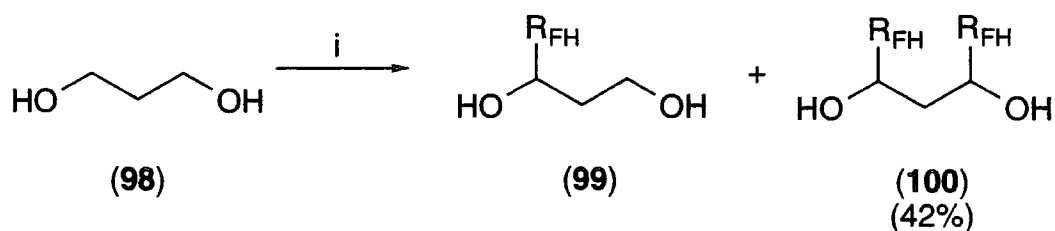

i) 2HFP, acetone, γ -rays, room temperature, 10 days.

ii) $\text{R}_{\text{FH}} = \text{CF}_2\text{CFHCF}_3$

Reaction conversion is lower than for the analogous pentane-2,4-diol addition (section 4.3.a.), reflecting the reduced nucleophilicity of secondary radical centres when compared to tertiary radicals. However, the increased electron density at radical sites adjacent to oxygen due to lone pair resonance is still sufficient to induce reaction, and 'back-biting' may proceed *via* a six-membered transition state to produce the di-adduct (100). Peroxide initiated reaction of (98) with three equivalents of HFP results in increased diol conversion, and (100) was isolated in 61% yield.

Butane-1,4-diol (7) was reacted with three equivalents of HFP and gave both mono- and di-adducts (identified by GCMS, ratio ca. 1:5). The mono-adducts could not be separated from the starting material and only the di-adduct (9) was isolated, in moderate yield (45%).

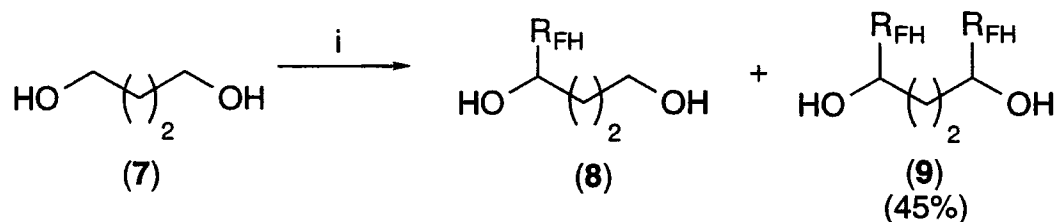

i) 3HFP, acetone, γ -rays, room temperature, 10 days.

ii) $\text{R}_{\text{FH}} = \text{CF}_2\text{CFHCF}_3$

The isolated yield represents a significant improvement to the figure reported by Paleta³⁶ (6%), and the reactivity of the diol towards HFP is in fact similar to that of propane-1,3-diol (98), the increasing distance between hydroxyl units reducing inductive electron withdrawal on the adjacent radical centre but 'back-biting' being disfavoured as a seven membered transition state is required. Peroxide initiated reaction of (7) with an excess of HFP again gave improved diol conversions, and (9) was obtained in 58% yield.

4.3.c. Selectivity and 'Back-Biting'.

Diols with both primary and secondary hydroxyl units allow the difference in reactivity between the two oxygen-stabilised radical sites to be quantitatively measured. Butane-1,3-diol (**101**) was thus reacted with a deficiency of HFP under γ -ray initiation and the product composition is recorded in table 4.3.c.i.

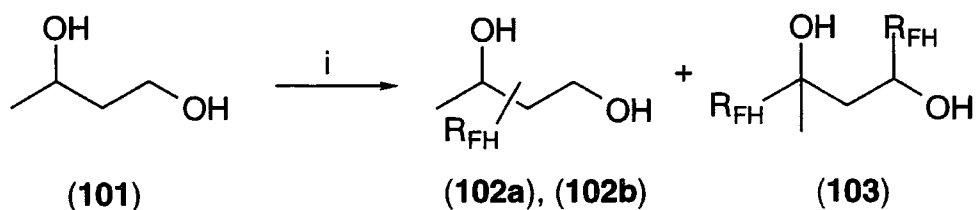

i) HFP, acetone, γ -rays, room temperature, 10 days.

ii) $R_{FH} = CF_2CFHCF_3$

Compound	Relative Composition ^a (%)	Ratio	Statistically Corrected Ratio
 (101)	76.8	-	-
 (102a)	13.2	3.4	6.8
 (102b)	3.9	1.0	1.0
 (103)	6.1	1.6	1.6

Table 4.3.c.i. Butane-1,3-diol site competition results.

a) Composition of the reaction product using GC ratios.

Butane-1,3-diol (**101**) has been previously reported to be unreactive towards fluoroalkenes under radical conditions,⁶⁴ but good conversions of HFP were obtained

(ca. 62%). The initial hydrogen atom abstraction occurs *preferentially* adjacent to the secondary hydroxyl group, this C-H bond having the lowest BDE (section 1.3.a.) and the derived radical being the most stabilised by inductive electron donation. However, a significant fraction of *both* of the radicals derived from addition of (101) to HFP (below) abstract a hydrogen atom intramolecularly and this results in di-addition (the statistical chances of di-addition being small when a deficiency of fluoroalkene is used).

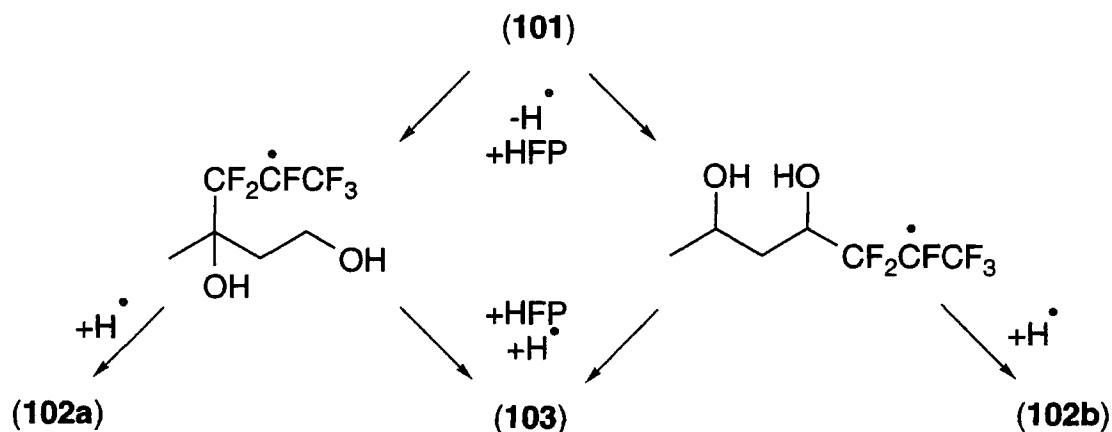

This does not alter the calculated overall reactivity difference between the two sites adjacent to hydroxyl, however, as we can only assume that the two fluoroalkyl radicals above contribute towards (103) in the same ratio (6.8:1.0) in which they are produced. The statistically corrected difference in reactivity between the secondary and primary alcohol sites is consistent with the well documented greater reactivity of tertiary hydrocarbon sites over secondary hydrocarbons,⁷⁹ and this reflects the relative nucleophilicities of the two alcohol-stabilised derived radicals.

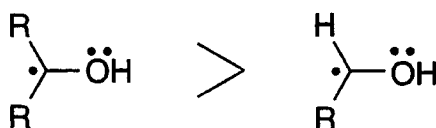

Scheme 4.3.c.i. Nucleophilicities of oxygen-stabilised radical centres.

The total ratio of mono-adducts (102a + 102b) to di-adduct (103) is 2.8:1.0, and if the bulk of the di-adduct is indeed generated *via* 'back-biting' this implies that approximately one in every four mono-additions results in intramolecular di-addition, intermolecular chain transfer competing effectively with intramolecular hydrogen atom abstraction.

The ^{19}F NMR spectrum of the product mixture was highly complex, reflecting the diastereomeric nature of compounds (**102a**), (**102b**) and (**103**), and the adducts were identified on the basis of their mass spectra although they could not be fully separated by either column chromatography or fractional distillation. Adduct (**102a**) displays peaks at m/z 195 and 45, corresponding to the $[\text{M}-\text{CH}_2\text{CH}_2\text{OH}]^+$ and $[\text{CH}_2\text{CH}_2\text{OH}]^+$ ions respectively and arising from fragmentation of the molecular ion at adjacent to the quaternary carbon centre bearing the hexafluoropropyl group. The heavier daughter ion fragments further, giving peaks at m/z 151 and 43 which correspond to the $[\text{R}_{\text{FH}}]^+$ and $[\text{CH}_3\text{C}=\text{O}]^+$ ions, the latter of which can also arise from the decomposition of the $[\text{CH}_2\text{CH}_2\text{OH}]^+$ ion.

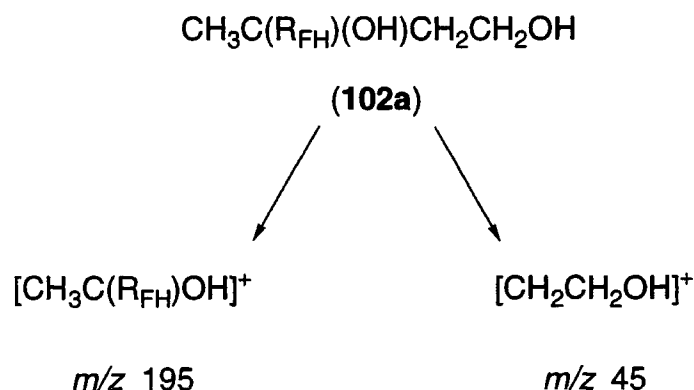

Adduct (**102b**) also displays a peak at m/z 195, in this case generated by the $[\text{M}-\text{CH}_3\text{CH}(\text{OH})]^+$ ion. However, (**102b**) can be distinguished from (**102a**) on the basis of a very strong peak at m/z 59, corresponding to the $[\text{CH}_3\text{CH}(\text{OH})\text{CH}_2]^+$ ion, which also arises from fragmentation adjacent to the hexafluoropropyl group.

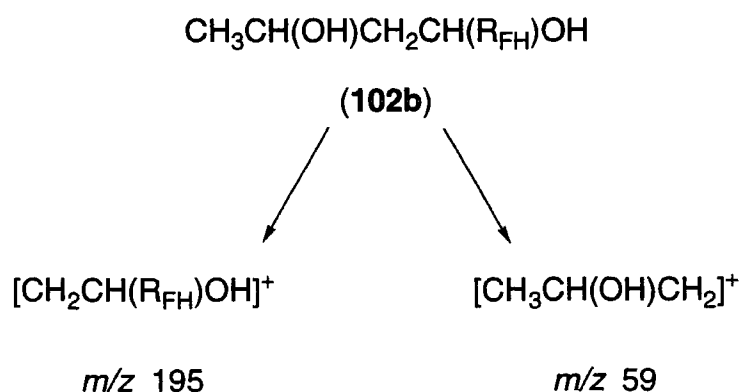

Diadduct (**103**) is readily identified by its significantly higher retention time and displays a clear $[\text{M}-\text{R}_{\text{FH}}]^+$ peak in its mass spectrum at m/z 239.

In an attempt to reduce the potential for inductive electron withdrawal to affect the relative nucleophilicities of the two hydroxyl sites, hexane-1,5-diol (**104**) was reacted with a deficiency of HFP under γ -ray initiation and the results are contained in table 4.3.c.ii.

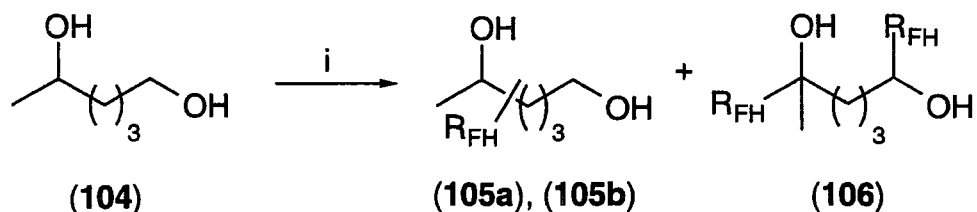

i) HFP, acetone, γ -rays, room temperature, 10 days.

ii) $\text{R}_{\text{FH}} = \text{CF}_2\text{CFHCF}_3$

Compound	Relative Composition ^a (%)	Ratio	Statistically Corrected Ratio
 (104)	77.8	-	-
 (105a)	15.7	6.5	13.0
 (105b)	2.4	1.0	1.0
 (106)	4.1	1.7	1.7

Table 4.3.c.ii. Intramolecular competition reaction results.

a) Composition of the reaction product using GC ratios.

Addition at the most substituted hydroxyl site is once more predominant, the mixture again being difficult to separate but the adducts being identified by their mass spectra as before. The statistically corrected ratio of the two mono-adduct isomers (assuming that **(106)** is produced by the radical precursors to **(105a)** and **(105b)** in their reactivity ratio

above) is now 13.0:1.0, and this increase reflects the increased spacing between oxygen centres, their inductive electron withdrawal upon each other being greatly reduced.

The 1,5-di-adduct (**106**) is again formed in larger than statistical quantities, the total ratio of mono-adducts to di-adduct being 4.4:1.0 and implying that intramolecular hydrogen atom abstraction occurs approximately once in every five mono-additions. This reduced 'back-biting' rate is also attributable to the increased spacing between hydroxyl groups, the intramolecular reaction now requiring an eight-membered transition state which is kinetically disfavoured.

The mass spectrum of (**105a**) shows a clear peak at m/z 195, corresponding to the $[M-(CH_2)_4OH]^+$ ion, again arising from fragmentation of the molecular ion adjacent to the quaternary carbon bearing the polyfluoroalkyl group. A small peak at m/z 73 is attributable to the $[(CH_2)_4OH]^+$ ion, but this decomposes rapidly to give the $[CH_3CO]^+$ ion at m/z 43. (**105b**) shows a different fragmentation pattern, there being no quaternary carbon centre in the molecule, and peaks at m/z 253 and 235 correspond to the $[M-CH_3]^+$ and $[M-CH_3-H_2O]^+$ ions respectively. Diadduct (**106**) is identified by its higher retention time and peaks at m/z 417 and 399, arising from the $[M-H]^+$ and $[M-H_3O]^+$ ions respectively.

4.4. Hydroxy-ethers.

Radical additions of fluoroalkenes to both cyclic⁶² and acyclic⁵⁶ ethers have been reported (section 1.4.e.), the reactions proceeding adjacent to oxygen *via* a heteroatom-stabilised carbon radical (**107**) similar to that derived from an alcohol.

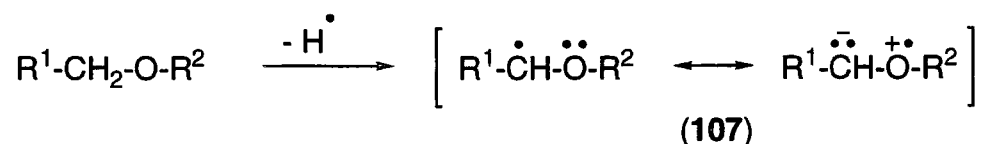

$R^1 = R^2 = \text{alkyl, cycloalkyl}$

However, whilst 1,2-dioxygenated ethers such as polyethylene glycol (PEG) are known to undergo radical addition to HFP,⁶⁵ ethane-1,2-diol³⁶ and cyclohexane-1,2-diol (**89**) are unreactive. Hence we were prompted to quantitatively compare the reactivities of ether-oxygen and hydroxy-oxygen stabilised radicals, and the additions of a number of hydroxy-ethers to HFP were investigated.

4.4.a. 2-Hydroxy Tetrahydrofuran.

2-Hydroxy tetrahydrofuran (**108**) was reacted with a deficiency of HFP under γ -ray initiation.

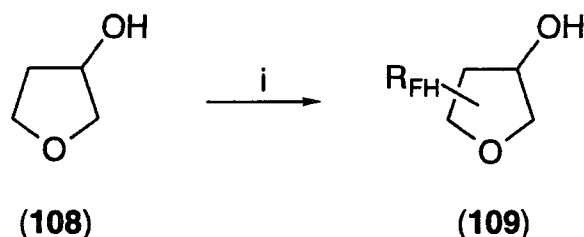

i) HFP, acetone, γ -rays, room temperature, 10 days.

ii) $R_{FH} = CF_2CFHCF_3$

Three mono-adducts were identified by GCMS (overall ratio of 1.0 : 2.2 : 2.3), and ^{19}F NMR of the product mixture showed a complex group of difluoromethylene signals. However, a clear AB quartet occurs centred at approx. -125 ppm, and the chemical shift of this resonance is very similar to that obtained from the cyclohexanol adduct (**46**) ($\delta_F = -127$ ppm, section 2.2.a.), implying reaction adjacent to hydroxyl. The remaining difluoromethylene signals occur in the region -116 to -124 ppm, and these chemical shifts are similar to that of the tetrahydrofuran-HFP adduct.⁵⁶

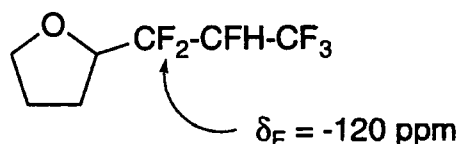

It thus seems that reaction occurs at all three sites adjacent to oxygen, but the mixture proved difficult to separate. However, the mass spectrum of the lesser product was considerably different to those of the two major species, and bore distinct similarities to the spectra of the cyclic alcohol adducts (section 2.2.c.). A peak at m/z 218 was observed, corresponding to $[M-20]^+$ and arising from consecutive dehydration and dehydrogenation of the molecular ion to produce the polyfluoroalkylated furan. Such a fragmentation of the molecular ion *via* a tertiary carbon-hydroxyl bond has been mentioned (section 2.2.c.), and this decomposition process is not in evidence in the spectra of the other two products. The lesser product can hence be tentatively assigned to being the hydroxyl-adduct (**110**).

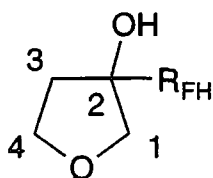

(110)

Therefore, the other two products must arise from addition at either side of the ether linkage (sites 1 and 4), and using these assignments to statistically adjust the product distribution gives a reactivity ratio of 1.0 : 1.1 : 1.2. The first of these figures corresponds to addition at hydroxyl, whilst the second most probably represents addition at site 1, steric crowding and inductive electron withdrawal by hydroxyl rendering this position slightly less reactive than site 4.

There is hence very little overall difference in the reactivities of the three sites adjacent to oxygen in (108). However, addition at hydroxyl proceeds *via* a tertiary radical, whilst additions adjacent to the ether oxygen atom occur *via* secondary intermediates. It has been mentioned that tertiary hydroxyl-stabilised radicals are more reactive than secondary hydroxyl-stabilised radicals (section 4.3.c.), and secondary ether-stabilised radicals are thus similarly more reactive towards HFP than the equivalent hydroxyl-stabilised positions.

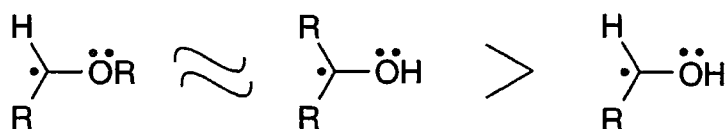

Scheme 4.4.c.i. Reactivities of oxygen-stabilised radical centres.

This higher reactivity of secondary ether-stabilised radicals over the secondary hydroxyl-stabilised analogues can be rationalised by electronic effects, as the conjugative donation from oxygen to the radical centre is clearly dependent on the electron density on the heteroatom. An alkyl substituent on oxygen inductively increases this electron density, improving delocalisation and rendering the ether-derived radical more nucleophilic and hence more reactive towards HFP than that derived from the alcohol.

4.4.b. Tetrahydrofurfuryl Alcohol.

To *directly* compare secondary ether-stabilised and secondary hydroxy-stabilised sites, tetrahydrofurfuryl alcohol (**111**) was reacted with a deficiency of HFP under γ -ray initiation to give one major product in moderate isolated yield and many trace components.

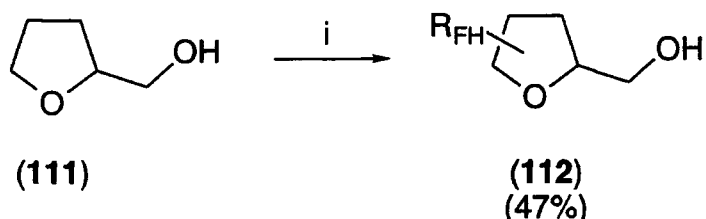

i) HFP, acetone, γ -rays, room temperature, 10 days.

ii) $R_{FH} = CF_2CFHCF_3$

The product was identified as being a mono-adduct on the basis of mass spectrometry data, but the NMR data for the isolated compound was unusual. Surprisingly, the ^{19}F NMR resonance arising from the difluoromethylene group was centred at ca. -82 ppm, a downfield shift of approx 40 ppm from the expected location (section 2.2.a.). The chemical shift value of this difluoromethylene signal is very close to that of the trifluoromethyl group (ca. -75 ppm), implying that the fluorine nuclei within the two functionalities are in similar magnetic environments. Furthermore, the 1H NMR spectrum shows signals for both the exocyclic methylene and all seven ring hydrogen nuclei, and IR data revealed that addition had occurred at the O-H bond, generating the hexafluoropropyl ether (**113**).

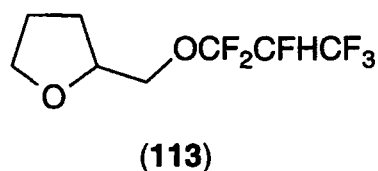

It is the electronegativity of the adjacent oxygen atom that renders the chemical shift of the difluoromethylene group in (**113**) similar to that of the trifluoromethyl group. Generation of ether (**113**) was not reproduced, however, when carefully purified furfuryl alcohol was reacted with HFP under radical conditions on the NMR scale. ^{19}F NMR of the product mixture was extremely complex, implying that the radical addition had occurred at multiple sites adjacent to oxygen, and the mixture of adducts could not be separated. Clearly the reaction of the hydroxy ether with HFP is quite sensitive

towards traces of base, which induces *ionic* nucleophilic addition *via* oxygen similar to that reported for butane-1,4-diol by Paleta (section 1.4.a.).³⁶

4.4.c. Competition Between Cyclopentanol and 2-Hydroxytetrahydrofuran.

To quantitatively determine the effect of a second oxygen atom on the radical addition process, a mixture of cyclopentanol (**53**) and 2-hydroxy tetrahydrofuran (**108**) was irradiated with a deficiency of HFP.

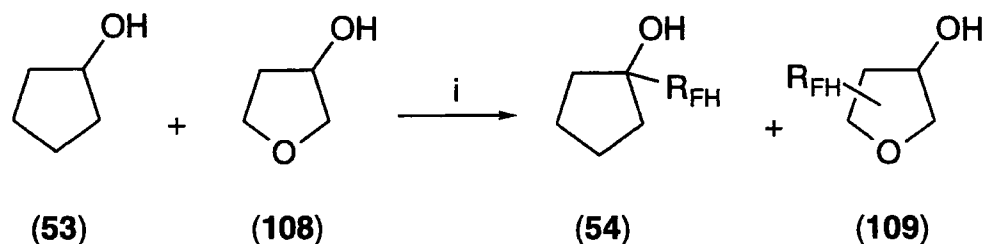

i) HFP, acetone, γ -rays, room temperature.

ii) $R_{FH} = CF_2CFHCF_3$

Compound	Composition Prior to Reaction ^a (%)	Composition After Reaction ^a (%)	Conversion (%)	Statistically Corrected Conversion (%)
 (53)	66.20	20.91	68.41	68.41
 (108)	33.80	8.56	74.67	14.93

Table 4.4.c.i. Competition reaction results.

a) Using GC ratios and incorporating response factors.

Cyclopentanol (**53**) reacts selectively at the single tertiary carbon-hydrogen bond under radical conditions (section 2.3.), whilst it has been shown that the five carbon-hydrogen bonds adjacent to oxygen in 2-hydroxytetrahydrofuran (**108**) are of approximately equal reactivity (section 4.4.a.). The site adjacent to hydroxyl in (**53**) is thus over four times more reactive towards HFP than the analogous site in (**108**), which clearly has reduced nucleophilicity due to inductive electron withdrawal by the nearby ether oxygen atom.

4.5. Cyclic Fluoroalkenes.

Cyclopentanol (**53**) reacts with perfluorocyclopentene in good yield under γ -ray irradiation to give the corresponding mono-adduct (**114**).

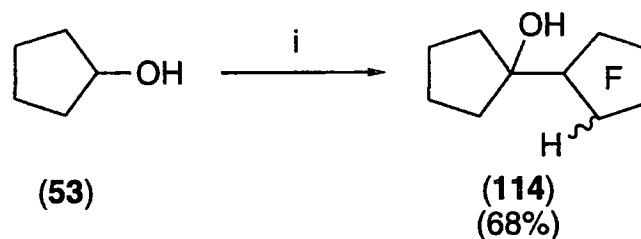

i) Perfluorocyclopentene, acetone, γ -rays, room temperature, 10 days.

A mixture of *cis* and *trans* geometric isomers about the fluorinated ring was obtained, and initially it is difficult to determine which isomer is predominant. Section 4.5.a. contains the evidence and discussion as to which isomer is preferentially formed in the addition process, but reaction occurs selectively at the hydroxyl carbon site as determined by ^{13}C NMR.

Reactions with perfluorocyclohexene proceeded similarly, giving the mono-adducts in good yield.

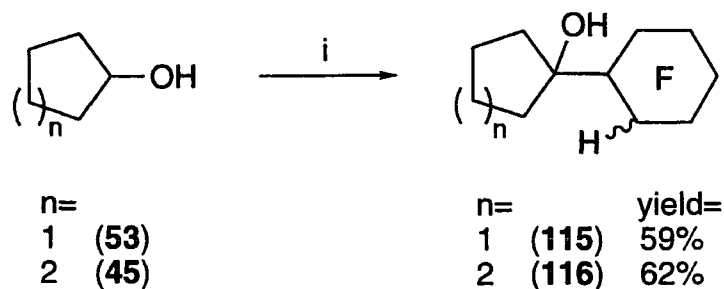

i) Perfluorocyclohexene, acetone, γ -rays, room temperature, 10 days.

Cyclic fluoroalkenes, being symmetrical about the double bond, are much less polar than HFP and the rate of reaction is correspondingly lower. Unreacted fluoroalkene was recovered in all cases (ca. 5-15%) after the usual irradiation time, and the isolated yields of the alcohol adducts were slightly lower than their hexafluoropropyl analogues.

4.5.a. Orientation of Addition.

The cyclopentanol-perfluorocyclopentene adduct (**114**) was initially isolated as a mixture of two isomers in a 3:1 ratio, as determined by gas chromatography, and

these isomers were separated by column chromatography over silica gel. Atoms in the fluorinated ring are labelled as below for convenience.

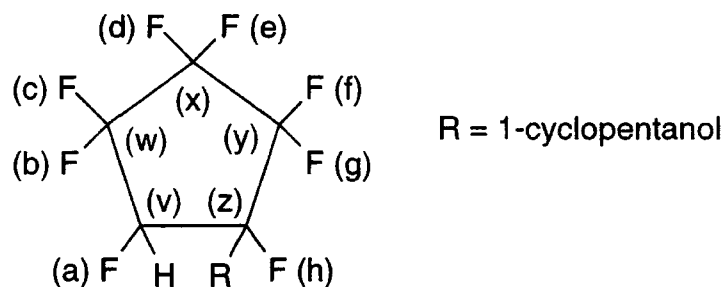

Structure 4.5.a.i. Labelling scheme for the octafluorocyclopentane group in (114).

The key factors in identifying each isomer are the chemical shifts of the tertiary (F(h)) and fluoromethylene (F(a)) fluorine atoms and the size of the three-bond hydrogen-fluorine ($^3J_{\text{HF}(h)}$) coupling across the fluorinated ring (Karplus postulate). Chambers *et al*⁷⁷ demonstrated that the *cis* and *trans* adducts of methanol and acetaldehyde with perfluorocyclopentene gave significantly different ^{19}F NMR data (table 4.5.a.i.).

Adduct	Cis Isomer (^{19}F , ppm)		Trans Isomer (^{19}F , ppm)	
	$\delta(\text{CFR})$	$\delta(\text{CFH})$	$\delta(\text{CFR})$	$\delta(\text{CFH})$
	-191	-228	-174	-215
	-195	-225	-181	-214

Table 4.5.a.i. ^{19}F NMR shifts of perfluorocyclopentene adducts.

The minor stereoisomer of adduct (114) gave ^{19}F NMR resonances at ca. -187 and -224 ppm, implying that it has a *cis* conformation. The major component gave signals at ca. -166 and -210 ppm, the lower chemical shifts corresponding well with the shifts of the *trans* isomers above. Furthermore, the *cis* product, in which the hydrogen and fluorine atoms are *anti*, would be expected to have a larger $^3J_{\text{HF}}$ coupling value than the *trans* product, in which these atoms are *syn*.

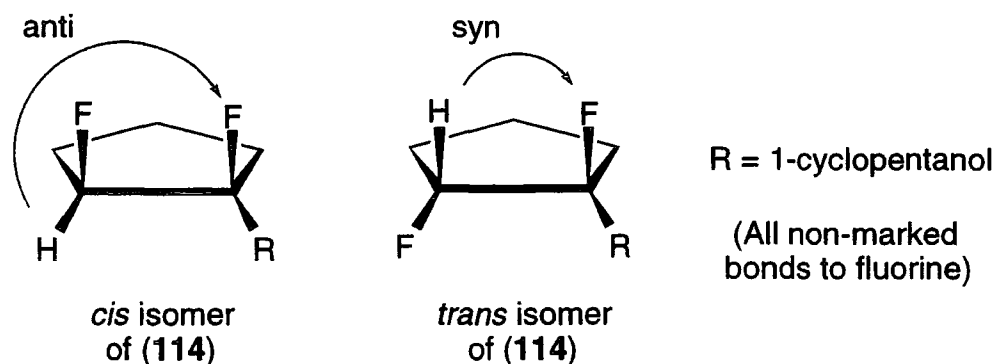

This effect is described in detail in a recent paper,⁸⁰ and the $^3J_{\text{HF}}$ vicinal coupling constants of a number of fluorinated five-membered rings were reported. In every instance the *anti* $^3J_{\text{HF}}$ coupling value is significantly higher than the *syn* coupling constant, overleaf being a typical example.

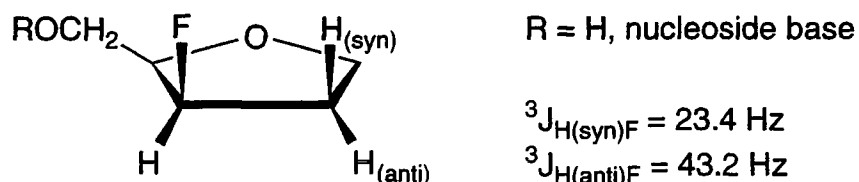

Indeed, the ^1H NMR spectrum of the minor isomer of (114) displays a $^3J_{\text{HF}}$ doublet coupling value of 18.8 Hz, this being much larger than the value of 11.6 Hz displayed by the major isomer. The *cis* isomer was thus identified by both methods as being the minor product, and this can be rationalised by steric interactions in the final radical intermediate.

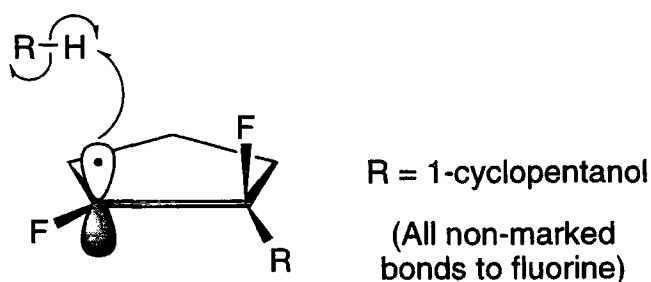

Chain transfer is preferentially performed with the relatively bulky cyclopentanol substituent *trans* to the incoming alcohol, as reported previously by Murumatsu.⁶¹

4.5.b. NMR Characterisation.

Having identified which isomer produces which spectra, the remaining data can be interpreted as before (section 2.2.) to complete the characterisation of the adducts. The fluoromethylene hydrogen atom gives a resonance in the region 5.0-6.0 ppm, and a typical splitting pattern is shown in spectrum 4.5.b.i.

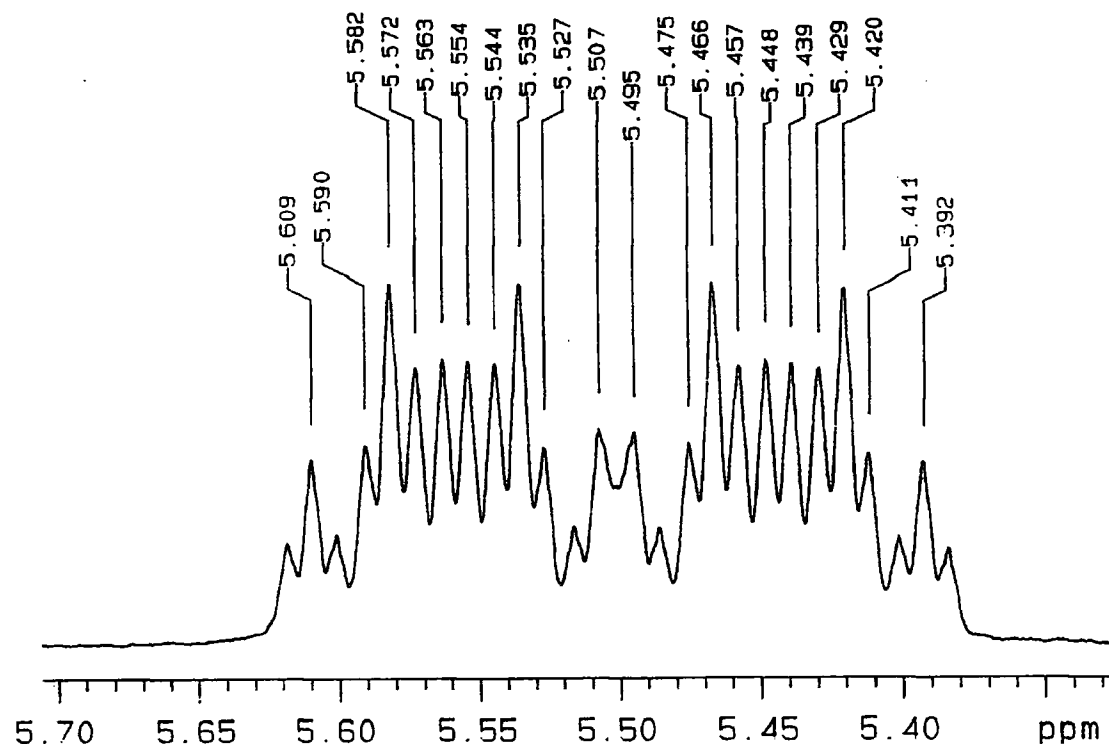

Spectrum 4.5.b.i. ^1H NMR signal arising from the fluoromethylene hydrogen nucleus in the *cis* isomer of (114).

The resonance is split by adjacent fluorine nuclei, splitting the signal into a doublet of doublets of triplets of triplets. For the *cis* cyclopentanol-perfluorocyclopentene adduct, these interactions have the coupling values shown in table 4.5.b.i.

Coupling.	Notation. (Multiplicity)	Value. (Hz)
H-F(a)	$^2J_{\text{HF}}$ (doublet)	46.0
H-F(b/c)	$^3J_{\text{HF}}$ (triplet)	11.2
H-F(d/e or f/g)	$^4J_{\text{HF}}$ (triplet)	3.6
H-F(h)	$^3J_{\text{HF}}$ (doublet)	18.8

Table 4.5.b.i. H-F coupling constants

Spectrum 4.5.b.ii. is the ^{19}F NMR spectrum obtained from the *cis* form of the cyclopentanol-perfluorocyclopentene adduct (114).

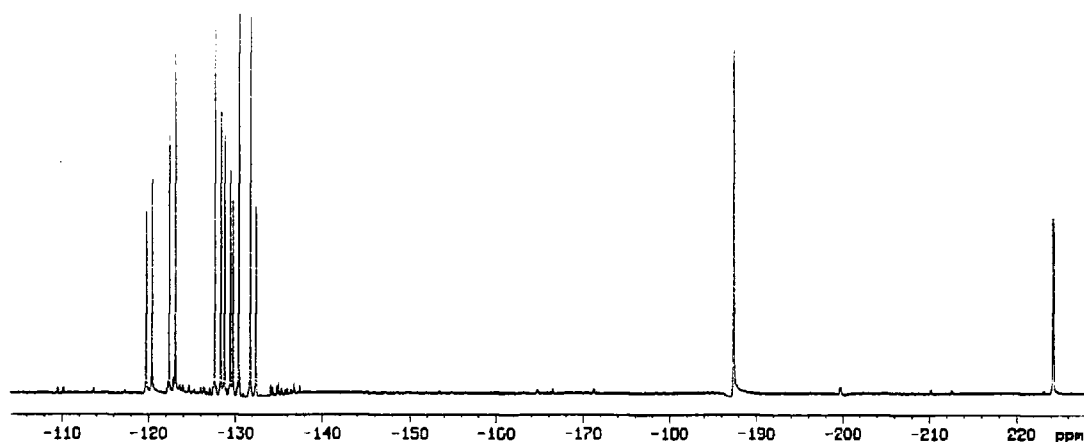

Spectrum 4.5.b.ii. ^{19}F NMR spectrum of the *cis* isomer of (114)

The singlet at ca. -187 ppm and the doublet at ca. -224 ppm are characteristic of the tertiary and fluoromethylene fluorine atoms respectively, the $^2J_{\text{FH}}$ coupling value for the latter being ca. 40 Hz. Signals between -119 and -133 ppm correspond to the ring difluoromethylene fluorine nuclei, and 2-dimensional $^{19}\text{F}^{19}\text{F}$ Correlated Spectroscopy (COSY) is of use in the interpretation of this area of the spectrum. Spectrum 4.5.b.iii. (below) was that obtained from the *cis* isomer of (114).

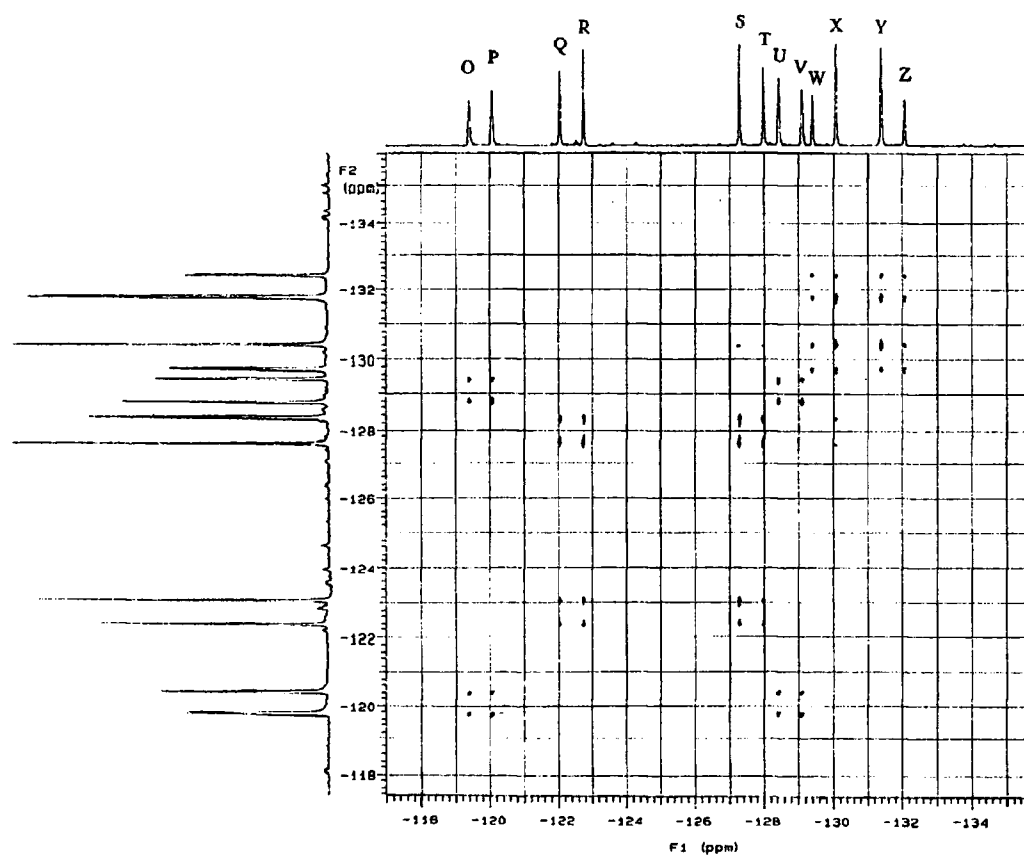

Spectrum 4.5.b.iii. $^{19}\text{F}^{19}\text{F}$ COSY of the *cis* isomer of (114)

Each of three AB quartets in the 1-D spectrum gives rise to a larger 'square' of four smaller 'squares' of 2-D signals, and extrapolation of these resonances along to the axes allow full peak assignment. (Table 4.5.b.ii.)

Interacting Peaks.	J _{AB}
O,P,U,V	252
Q,R,S,T	266
W,X,Y,Z	254

Table 4.5.b.ii. ¹⁹F¹⁹F COSY peak assignments.

4.6. Conclusions.

- The inductive and steric effects of hydroxyl vary strongly with distance, as 1,4- and 1,3-diols react well under radical conditions but 1,2-diols do not.

- Primary acyclic diols react less efficiently than secondary acyclic diols, reflecting the reduced nucleophilicity of the derived radicals. Radicals derived from primary alcohols are up to 13 times less reactive towards HFP than those derived from secondary alcohols.

- Secondary ether-stabilised radicals are of similar reactivity to tertiary hydroxyl-stabilised radicals, giving rise to the following reactivity pattern.

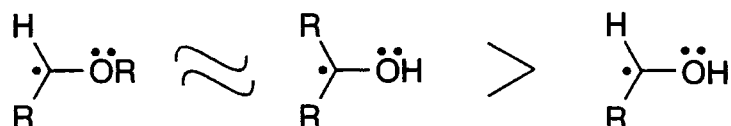

- Inductive electron withdrawal by the ether oxygen atom renders the hydroxyl site in 2-hydroxytetrahydrofuran much less nucleophilic than the analogous hydroxyl site in cyclopentanol.

- Additions to cyclic fluoroalkenes have been achieved, despite the alkenes being less polar than their HFP analogues, and mixtures of geometric isomers are formed.

Chapter 5: Adduct Functionalisation.

5.1. Introduction.

Having investigated the radical addition of alcohols, diols and hydroxy-ethers to fluoroalkenes (Chapters 2, 3 & 4), we were next prompted to investigate the chemistry of the products. There are two sites at which it is possible to introduce functionalisation into the simple cyclic alcohol adducts, these being the fluoromethylene hydrogen atom and the tertiary hydroxyl group.

5.2. Dehydrofluorination.

Several methods for the dehydrofluorination of ether-HFP adducts have been reported, with potassium hydroxide and alkoxide bases giving good conversions.^{34, 81, 82} In all cases a mixture of the Z- and E-alkenes was produced, in a ratio varying between 1:1 and 2:1, but these could not be separated.

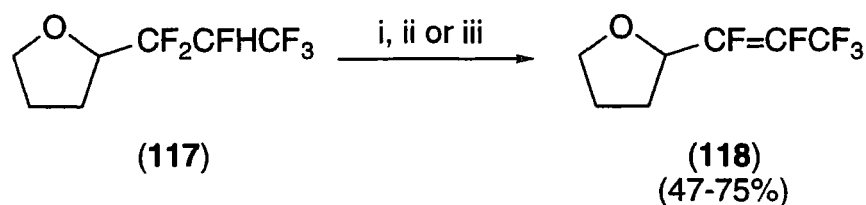

- i) KOH(s), 150°C.
- ii) KOH, diglyme, 120°C.
- iii) KO^tBu, ^tBuOH, 25°C.

Dehydrofluorination of the hexafluoropropyl group in alcoholic media often results in nucleophilic attack of the solvent on the newly formed double bond,⁸² and therefore alternative solvents were utilised. Dehydrofluorination of the cyclohexanol-HFP adduct (46) with an excess of potassium *tert*-butoxide (method 1) proceeded rapidly in hexane or diethyl ether at room temperature. However, the crude product solution was extremely dark in colour, and difficulties were encountered in the removal of the *tert*-butanol generated during the reaction. The analogous dehydrofluorination of (46) with an excess of potassium hydroxide in the same media (method 2) was less rapid, requiring stirring at room temperature for 24 hours, but the resulting product solutions were less coloured and purification was much easier.

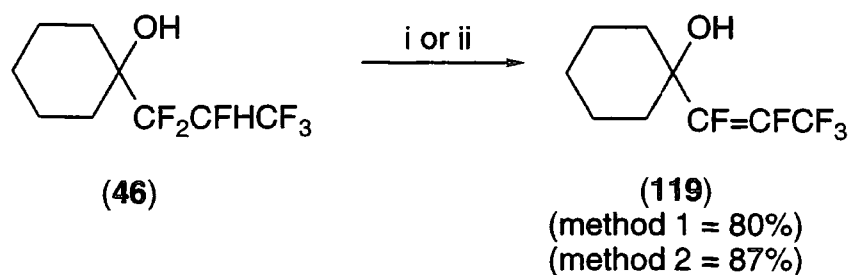

i) KO^tBu, C₆H₁₄ or Et₂O, 25°C, 30 mins.

ii) KOH, C₆H₁₄ or Et₂O, 25°C, 24 hours.

The ¹⁹F NMR spectrum of (119) consists of only three signals in a 3:1:1 ratio. The first signal (relative intensity 3) occurs at -67.56 ppm, corresponding to the trifluoromethyl fluorine atoms and confirming that the terminal alkene is not produced. The two vinylic fluorine atom resonances occur at -149.38 and -170.12 ppm, and the doublet coupling between these two fluorine atoms is 135 Hz. This is comparable with the coupling constants of simple 1,2-disubstituted ethenes.^{72, 83}

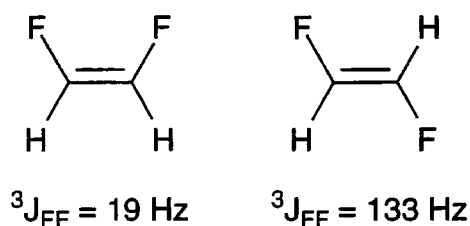

Therefore allylic alcohol (119) must be the E-isomer, the coupling constants being displayed in table 5.2.b.i.

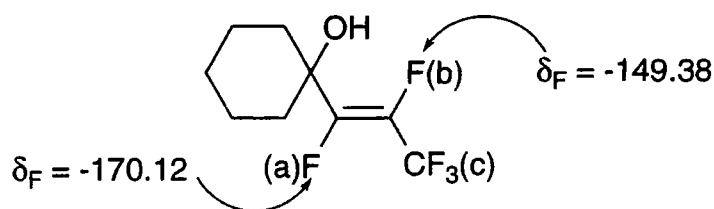

Characteristic NMR Chemical Shifts of (119).

Coupling.	Notation.	Value. (Hz)
F(a)-F(b)	${}^3J_{FF}$	135
F(a)-F(c)	${}^4J_{FF}$	10.2
F(b)-F(c)	${}^3J_{FF}$	22.4

Table 5.2.b.i. F-F coupling constants for (119).

Spink⁴³ reported that the cyclohexane-HFP adduct (120) gave the Z-alkene (121) under analogous dehydrofluorination conditions, with a $^3J_{\text{FF}}$ coupling constant of 31 Hz between the two vinylic fluorine atoms. It is surprising that the presence of the hydroxyl group in (46) induces such a dramatic change in regioselectivity, and this effect will be discussed later (section 5.3.b.). The same worker⁴³ demonstrated that deuterium is incorporated into the cyclohexane-HFP adduct (123) if a deficiency of base in deuterated *tert*-butanol was used, and this is consistent with an E1cB mechanism for the dehydrofluorination process.

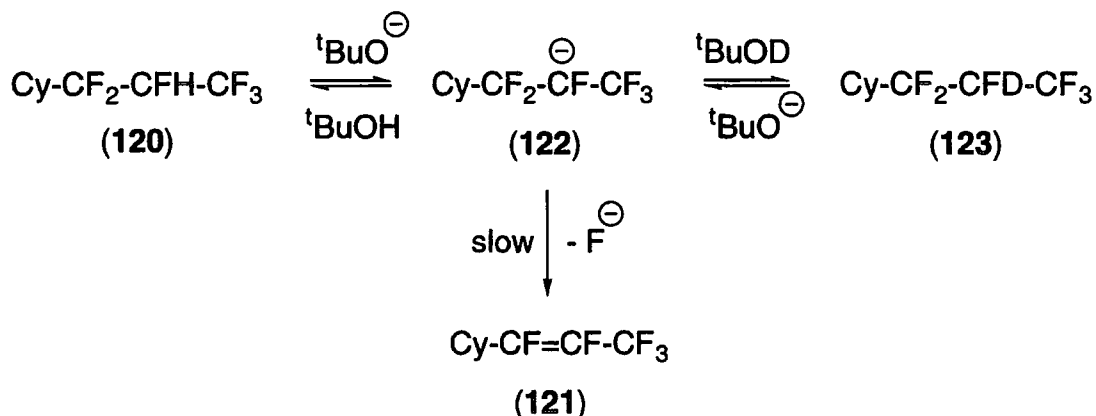

E1cB mechanism for dehydrofluorination of the hexafluoropropyl group.

i) Cy = Cyclohexyl.

The fluoromethylene proton is rendered the most acidic by the inductive electron withdrawal of the fluorine and fluoroalkyl substituents, and the derived anion (122) is inductively stabilised (section 1.3.d.i.) and undergoes rapid equilibrium with both protonated and deuterated *tert*-butanol. Elimination of fluoride from (122) is relatively slow, reflecting the high carbon-fluorine BDE, and it is well known that there is a significant electronic repulsion between fluorine lone pairs and adjacent π -electrons.² Thus (122) loses fluoride ion from the difluoromethylene group rather than the trifluoromethyl group, giving the alkene with fewest vinylic fluorine substituents (121).

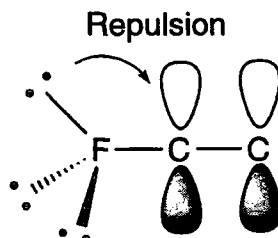

The cyclopentanol-HFP adduct (**54**) is also dehydrofluorinated by potassium hydroxide in hexane or diethyl ether (method 2) to give the E-alkene, the coupling constant between the two vinylic fluorine atoms also being 135 Hz.

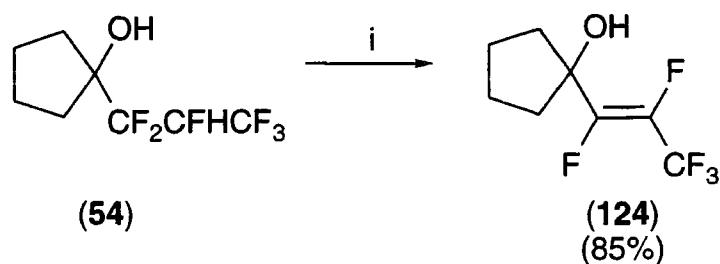

i) KOH, C₆H₁₄ or Et₂O, 25°C, 24 mins.

5.3. Functionalisation of Hydroxyl.

5.3.a. Esterification.

The alcohol-HFP adducts discussed in Chapter 2 contain tertiary alcohol centres and are relatively poor oxygen nucleophiles due to high steric demand. Furthermore, the inductive electron withdrawal of the hexafluoropropyl group will lower the electron density on oxygen, also decreasing the nucleophilicity of the species. Highly electrophilic reagents are required to esterify such deactivated systems, and refluxing 1-(1,1,1,2,3,3-hexafluoropropyl)-cyclopentanol (**54**) with an excess of acetyl chloride (**125**) required a 24 hour period to achieve quantitative conversion to the acetyl ester. This reaction time is much longer than that required for the analogous acetylation of cyclopentanol, nevertheless the ester (**126**) was isolated in good yield.

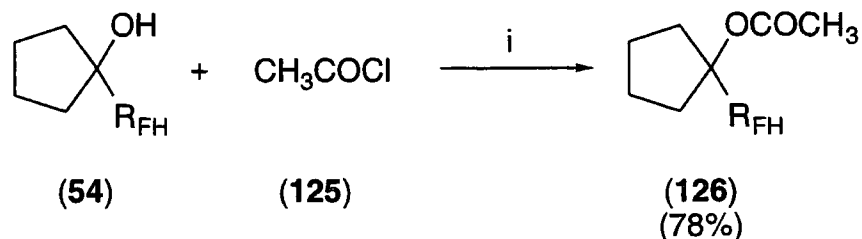

i) Reflux, 24 hours.

ii) R_{FH} = CF₂CFHCF₃

NMR is an extremely useful tool to follow the course of the esterification, and the simplest method involves monitoring the appearance of the difluoromethylene AB quartet (section 2.2.a.) in the ¹⁹F NMR spectrum. The chemical shift of this fluorinated group is the most affected by the functionalisation of oxygen, and upon acetylation of (**54**) the appearance of the CF₂ resonance alters significantly (spectra 5.3.a.i.). Notably,

whilst the AB quartet widens to a large degree, the $^2J_{\text{FF}}$ coupling constant remains virtually unchanged (alcohol (**54**) $J_{\text{AB}} = 275$ Hz, ester (**126**) $J_{\text{AB}} = 277$ Hz).

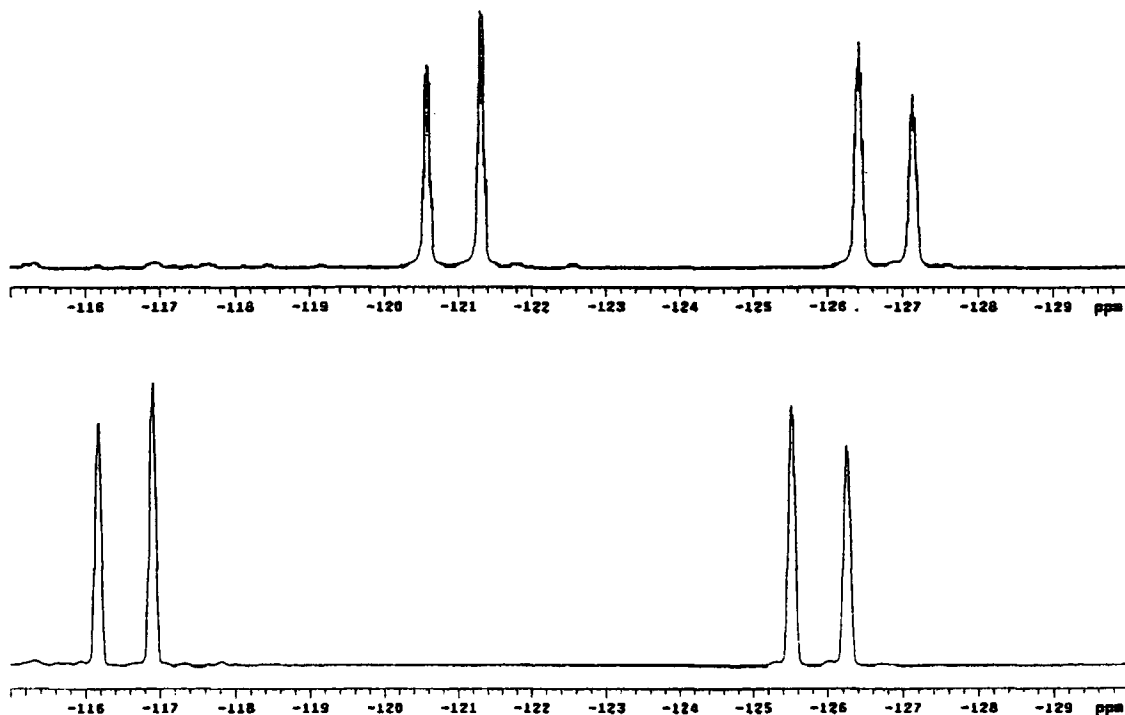

Spectra 5.3.a.i. ^{19}F NMR of (**54**) and (**126**).^a

a) Upper spectrum: ^{19}F difluoromethylene resonance of alcohol (**54**).

Lower spectrum: ^{19}F difluoromethylene resonance of ester (**126**).

The two difluoromethylene fluorine atoms in both (**54**) and (**126**) are diastereotopic (section 2.2.a.), and the average environments they experience will never be identical. Esterification increases the difference between the average environments of the two fluorine nuclei, and hence increases the difference between their chemical shifts. This effect may be due to restricted rotation⁸⁴ about the bond to the hydroxyl carbon atom, which is a consequence of the increased steric demand of the acetate group ($29.07 \text{ cm}^3\text{mol}^{-1}$) over the hydroxyl unit ($8.04 \text{ cm}^3\text{mol}^{-1}$).⁸⁵

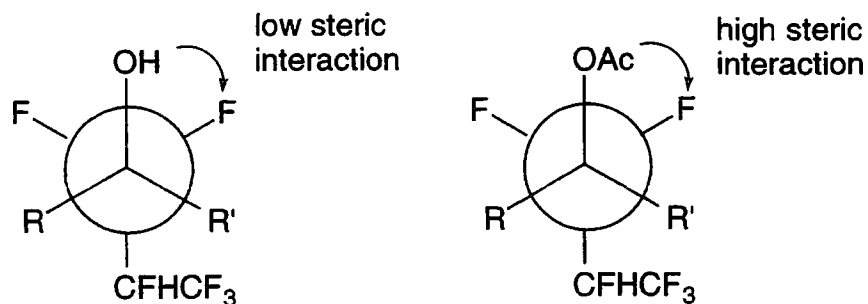

R and R' = cyclopentyl ring

Apart from the above change in the difluoromethylene ^{19}F NMR resonance, there are only two other significant differences in the NMR spectra upon esterification. Firstly, a singlet at 2.04 ppm with a relative intensity of 3 occurs in the ^1H NMR spectrum, and this is readily assigned as arising from the acetate methyl hydrogen atoms. Secondly, two extra singlets occur in the ^{13}C NMR spectrum, at 21.85 and 168.45 ppm, these being due to the methyl and carbonyl carbon atoms respectively.

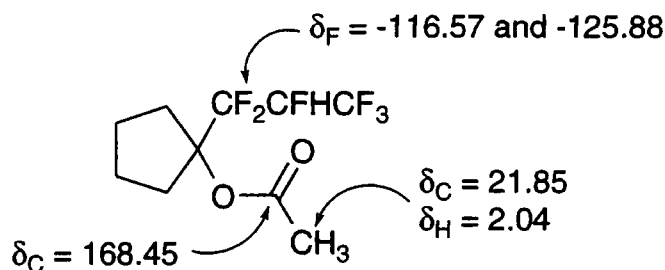

Characteristic NMR Chemical Shifts of (126).

The diol-HFP di-adducts discussed in section 4.3.a. can also be esterified using this methodology, and refluxing (94) with an excess of acetyl chloride (125) gave the diacetyl diester (127) in good isolated yield after 36 hours.

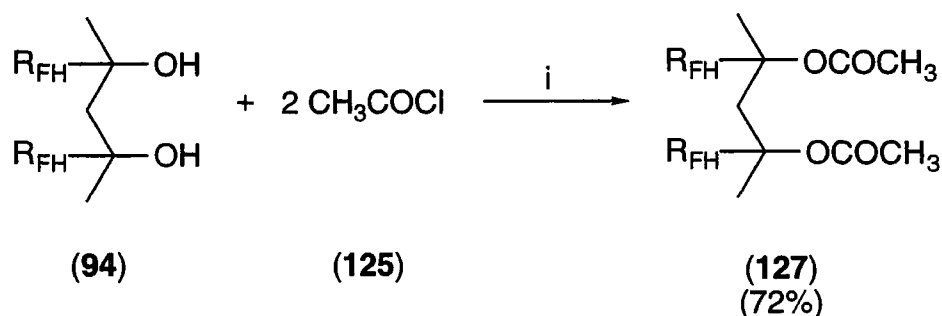

- i) Reflux, 36 hours.
- ii) $\text{R}_{\text{FH}} = \text{CF}_2\text{CFHCF}_3$

Characterisation of the diester (127) proceeded similarly to that of the ester (126) above. Benzoyl chloride (128) will also esterify (54), but a 48 hour period was required for complete conversion of the alcohol and this longer reaction time reflects the lower electrophilicity of the acid chloride.

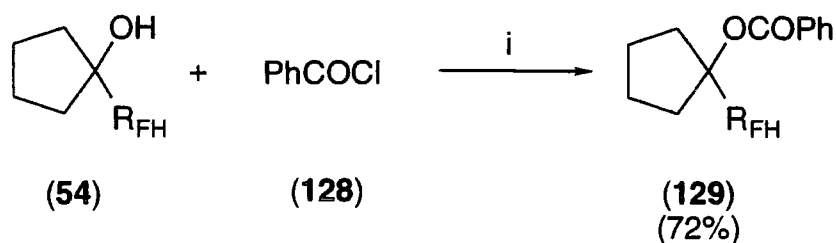

i) Reflux, 48 hours.

ii) $R_{FH} = \text{CF}_2\text{CFHCF}_3$

The difluoromethylene ^{19}F NMR resonance of alcohol (54) again shows significant widening upon esterification, and furthermore the ^{13}C spectrum of ester (129) shows five high-field resonances arising from the benzoyl functionality. The ^1H spectrum contains a complex group of aromatic signals, between 7.41 and 8.22 ppm, and the mass spectrum of (129) shows strong peaks at m/z 105 and 77, corresponding to the $[\text{PhCO}]^+$ and $[\text{Ph}]^+$ ions respectively.

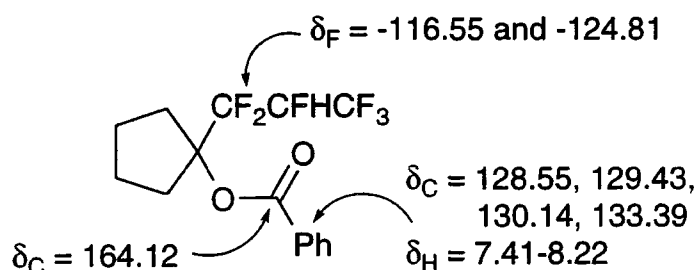

Characteristic NMR Chemical Shifts of (129).

The production of monomers containing polyfluoroalkyl substituents is of potential interest (section 1.4.d.), and refluxing (54) with an excess of methacryloyl chloride (130) gave the methacryloyl ester (131) in fair yield after 48 hours.

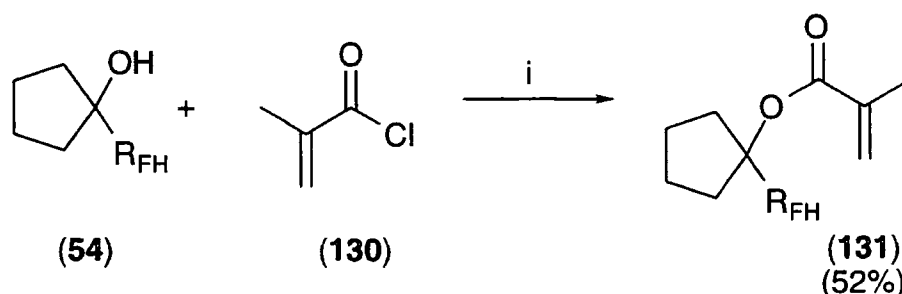

i) Reflux, 48 hours.

ii) $R_{FH} = \text{CF}_2\text{CFHCF}_3$

The reduced yield is attributable to polymerisation of the ester species both in the reaction vessel and during purification. Indeed, the susceptibility of this species to

polymerisation is reflected in the fact that (131) slowly solidified upon standing in sunlight, giving solids that were only sparingly soluble in acetone, and polyfluoroalkylated polymers have been reported by Paleta⁶⁴ to be used in various biomedical applications. Ester (131) also displays a wide difluoromethylene AB quartet resonance in the ¹⁹F NMR spectrum, and four ¹³C signals can be attributed to the methacrylate functionality. Three of these signals are at high field, corresponding to the unsaturated carbon atoms, and furthermore the ¹H spectrum displays two high-field singlets, attributable to the vinylic hydrogen atoms.

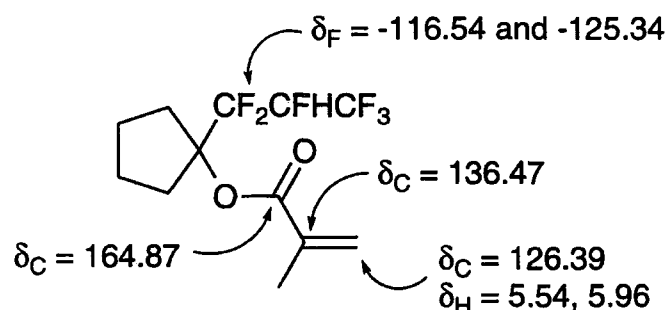

Characteristic NMR Chemical Shifts of (131).

5.3.b. Dehydrofluorination of the Ester (126).

Dehydrofluorination of (126) with an excess of potassium hydroxide in hexane (section 5.2.b.) gave the alkene (132) after 24 hours at room temperature.

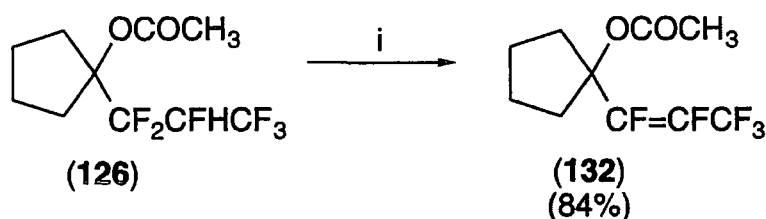

i) KOH, hexane, 25°C, 24 hours.

Only a single isomer of the alkene (132) was isolated, the ¹⁹F NMR spectrum consisting of three signals in a 3:1:1 ratio. The resonances for the two vinylic fluorine atoms occur at -119.96 and -156.16 ppm, and the ³J_{FF} coupling constant between the two nuclei is small, each signal consisting of an unresolved multiplet. The alkene (132) must thus have the Z- conformation, and indeed traces of the E- isomer (³J_{FF} 134 Hz) were detected in the crude reaction product prior to purification. There is hence a direct comparison between the dehydrofluorinations of hydrocarbon-HFP adducts,⁴³ alcohol-HFP adducts (section 5.2.) and functionalised alcohol-HFP adducts.

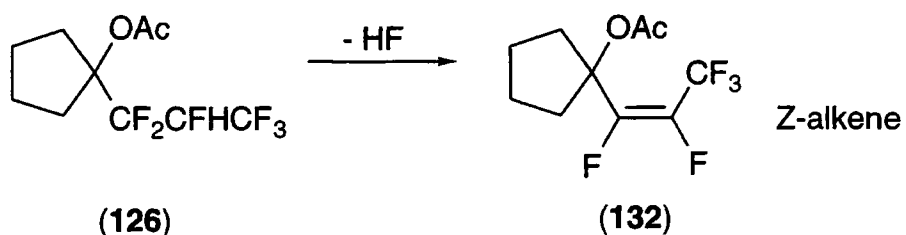
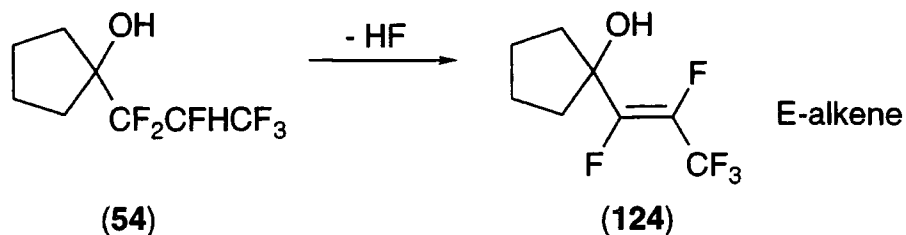
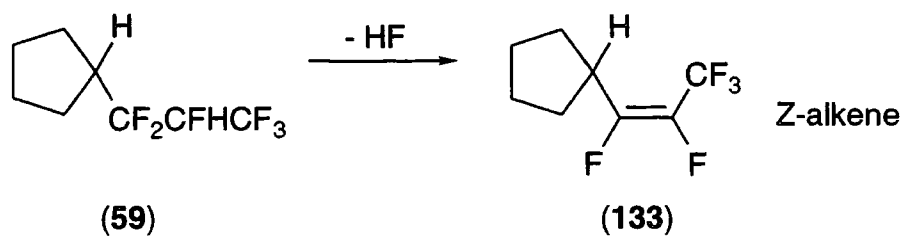

It has been reported that Z-alkene (133) undergoes thermal isomerisation to the analogous E-alkene (134) in the presence of caesium fluoride,⁴³ and it was concluded that the Z-form is in fact the kinetic product whilst the E-form is the thermodynamic product.

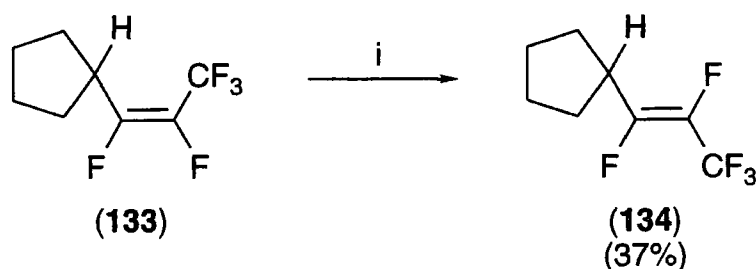

i) CsF, 200°C, 50 hours.

If dehydrofluorination of alkane (59) to form the Z-isomer (133) proceeds via *anti*-elimination, this implies that the intermediate anion (135) preferentially adopts the *gauche* conformation, which is surprising as the steric interaction between the trifluoromethyl group and the cyclopentane ring would be expected to favour the *trans* conformer. However, this preference for the *gauche* conformation is analogous to that seen in 1,2-difluoroethane,^{4, 86} and it has been argued that this is due to fluorine-

fluorine lone pair attractions.⁸⁷ Alternatively, it has been proposed that there may be a conjugative *destabilisation* of the *trans* isomer,⁸⁸ and controversy still exists.

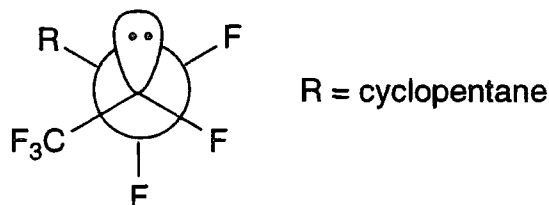

Gauche conformer of (135)

The elimination could in fact be *syn*, but this requires the trifluoromethyl group and the cyclopentane ring to be eclipsing, a very unfavourable interaction. Either way, it is beyond the scope of the current work to further investigate this elimination.

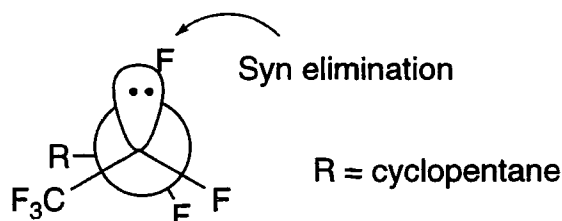

Syn conformer of (135)

Whilst dehydrofluorination of the cyclopentanol-HFP adduct (54) results in production of the thermodynamic product after 24 hours at room temperature, if (54) is briefly allowed to contact the base before being removed under vacuum a mixture of the *Z*- and *E*- isomers is obtained. This implies that an *in situ* isomerisation is occurring, and as the intermolecular fluoride ion catalysed isomerism of (133) to (134) requires temperatures of 200°C,⁴³ the isomerism of the *Z*-allylic alcohol to the thermodynamic product is thus likely to be *intramolecular*. A possible route is shown overleaf.

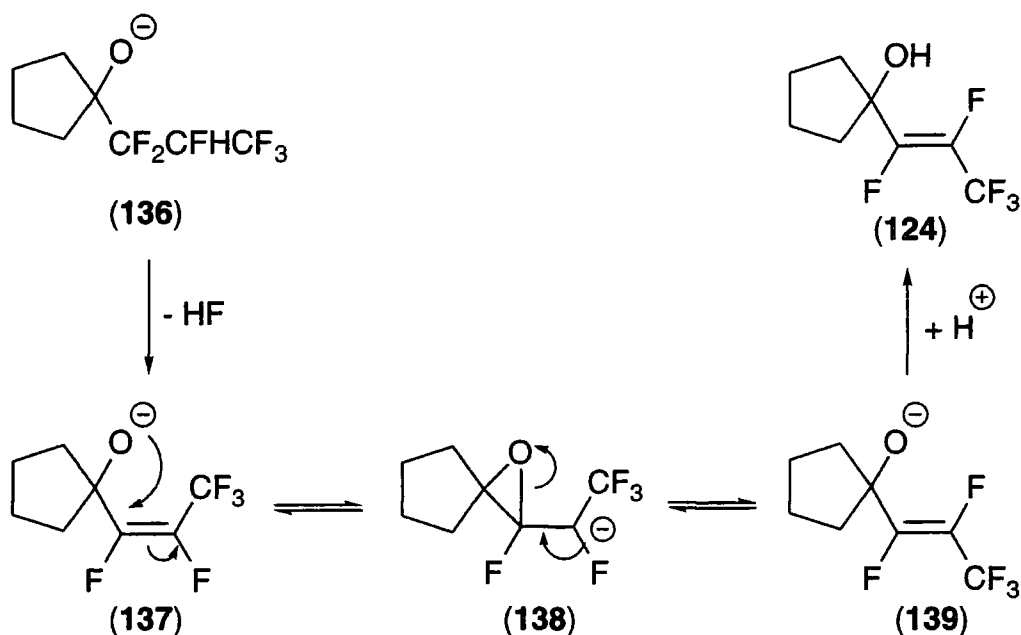

The most acidic proton in the cyclopentanol-HFP adduct (54) is the hydroxyl proton, and removal of this generates the oxy-anion (136). Dehydrofluorination of (136) yields the kinetically favoured Z- allylic alkoxide (137) which undergoes intramolecular nucleophilic attack to generate carbanion (138). The anionic centre is inductively stabilised by the trifluoromethyl group, and is in equilibrium with the thermodynamically favoured E- allylic alkoxide (139). Protonation during work-up then yields the E- allylic alcohol (124), and indeed if this mechanism is correct only when a potentially nucleophilic substituent is situated at the hydroxyl site will the E-alkene be produced, and dehydrofluorination of ester (126) could only give the observed Z- alkene.

5.3.c. Silylation.

When (54) was added at 0°C to a mixture of pyridine and trimethylsilyl chloride (TMSCl) a white precipitate quickly formed, which was removed by filtration and identified as the pyridine-hydrogen chloride salt (141). The TMS ether (140) was isolated in good yield from the remaining liquor after column chromatography.

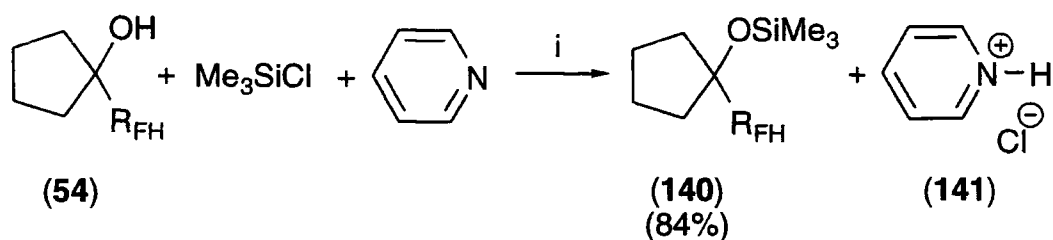

i) 0°C, 24 hours.

ii) R_{FH} = CF₂CFHCF₃

Characteristic signals are in evidence in the NMR spectra of the silyl ether (140), and a singlet (with spinning side bands) of relative intensity 9 occurs at 0.17 ppm in the ^1H NMR spectrum. The ^{13}C spectrum also contains a new singlet, at 1.76 ppm, attributable to the three equivalent carbon nuclei in the trimethylsilyl group, and the ^{19}F spectrum contains a widely spaced difluoromethylene AB quartet.

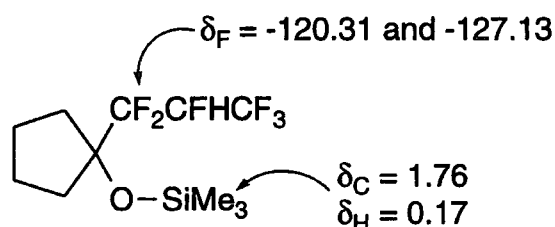

Characteristic NMR Chemical Shifts of (140).

5.4. Dehydration.

Many methodologies for the dehydration of alcohols have been developed,⁸⁹ and a mixture of thionyl chloride and pyridine has been reported to effectively dehydrate some tertiary alcohols.^{37, 90, 91} Indeed, cyclohexanol adduct (46) gave the polyfluoroalkylated cyclohexene (142) in quantitative conversion upon treatment with thionyl chloride and pyridine at 0°C (method 1). However, the reaction is highly exothermic and the product mixture is dark and viscous, leading to difficulties in purification. In contrast, heating (46) with thionyl chloride alone⁹² (method 2) gave (142) in improved yield, the product mixture being less coloured and much more fluid.

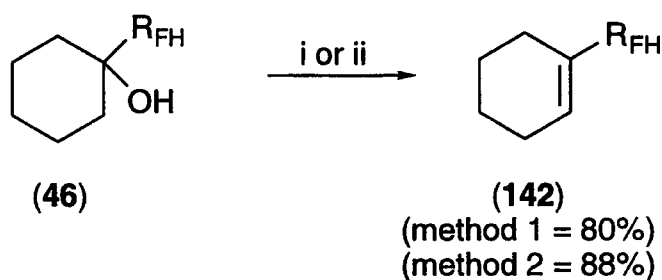

i) SOCl_2 , Pyridine, 0°C, 24 hours.

ii) SOCl_2 , Reflux, 24 hours.

iii) $\text{R}_{\text{FH}} = \text{CF}_2\text{CFHCF}_3$

The reaction progress is conveniently monitored by ^{19}F NMR, and the chemical shift of the difluoromethylene resonance is characteristic. Alcohol (46) displays an AB quartet at -126.91 and -128.51 ppm (section 2.2.a.), and the analogous resonance in the alkene (142) occurs at -110.95 and -113.72 ppm, a downfield shift of ca. 15 ppm which reflects the increase in electron density at the adjacent site. Furthermore, the ^1H NMR

spectrum of (142) displays a strong resonance at 6.30 ppm, which is attributable to the vinylic hydrogen atom, and the ^{13}C NMR spectrum contains two strongly deshielded peaks corresponding to the unsaturated carbon atoms.

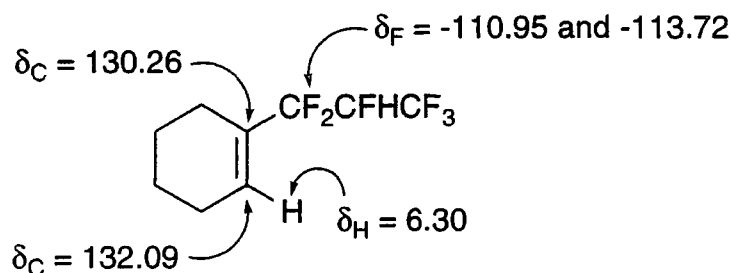

Characteristic NMR Chemical Shifts of (142).

A possible mechanism for the dehydration is suggested below.

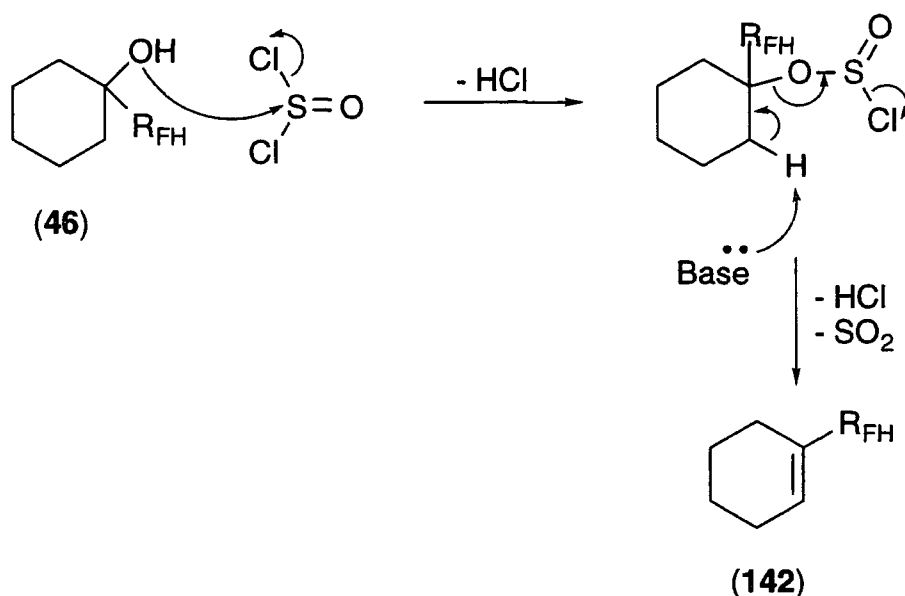

The base can be either pyridine (method 1) or chloride ion (method 2), and the elevated temperature required for the latter method reflects the lower basicity of chloride ion compared to pyridine⁹³ ($\text{pK}_{\text{a}} \text{HCl} = -7.0$, $\text{pK}_{\text{a}} \text{PyH}^+ = 5.3$). A range of alcohol-adducts can be dehydrated by method 2 in good isolated yields (table 5.4.i.), including adducts with cyclic fluoroalkenes. However, the isolated yield was only optimised for the dehydration of the cyclohexanol-adduct (46).

Alcohol.	Alkene.	Yield. (%)
 (54)	 (143)	65
 (56)	 (144)	60
 (77)	 (145)	56
 (114)	 (146)	71
 (116)	 (147)	58

Table 5.4.i. Dehydration of Alcohol-Fluoroalkene Adducts.

Characterisation of these alkenes gives similar data to that detailed above, and as would be predicted by Bredt's rule the norborneol-HFP adduct (**77**) does not give the bridgehead alkene (as determined by ^{13}C NMR).

Dehydration of diol-diadducts proved to be less facile, and both the pentane-2,4-diol-HFP diadduct and the hexane-2,5-diol-HFP diadduct gave complex mixtures upon refluxing with thionyl chloride. Dehydration of the cyclopentane-1,3-diol-HFP diadduct (**92**) gave a mixture of cyclopentadienes which could not be separated but which were characterised as a mixture.

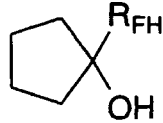
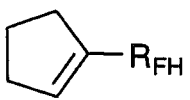
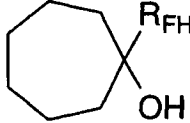
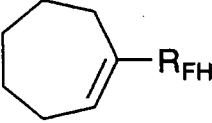
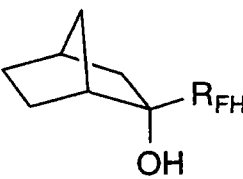
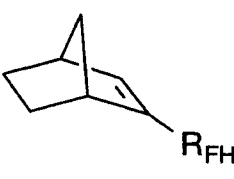
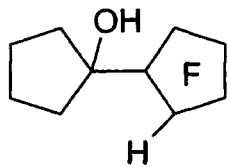
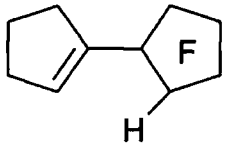
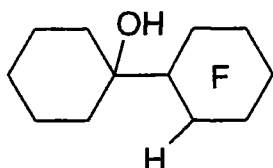
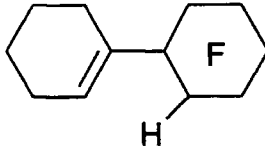
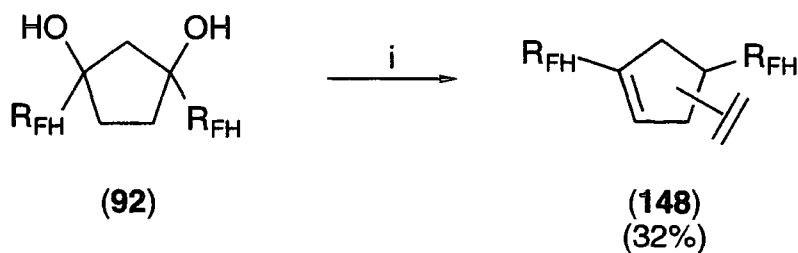

i) SOCl_2 , reflux, 24 hours.

ii) $\text{R}_{\text{FH}} = \text{CF}_2\text{CFHCF}_3$

The ^{19}F NMR spectrum of the product mixture was surprisingly clean, and two difluoromethylene AB quartets were present in a 1:1 ratio. Both the ^1H and ^{13}C NMR spectra were more complex, however, and it is difficult to determine whether the compound exists as a [2+4] cycloaddition dimer. The mass spectrum of (148) displays a distinct $[\text{M}]^+$ ion at m/z 366, and this decomposes to give peaks at m/z 265, 151 and 69, corresponding to the $[\text{M}-\text{CFHCF}_3]^+$, $[\text{R}_{\text{FH}}]^+$ and $[\text{CF}_3]^+$ ions respectively.

5.5. Alkene Reactivity.

The carbon-carbon double bond of alkene (142) has two electron donating alkyl substituents and one electron withdrawing fluoroalkyl substituent. (142) is thus subject to two conflicting electronic effects, and furthermore has a relatively high degree of steric crowding.

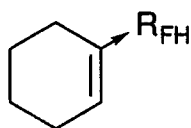

(142)

Indeed, while the chemistry of fluorinated alkenes is well studied,² alkenes with both fluorocarbon and hydrocarbon substituents are less common and few reports have been documented. Existing examples include Henne's report that 3,3,3-trifluoropropene reacts with a mixture of hydrogen chloride and aluminium trichloride to give the terminal chloride,⁹⁴ and Myhre's observation that the same alkene dimerises in fluorosulphonic acid.⁹⁵



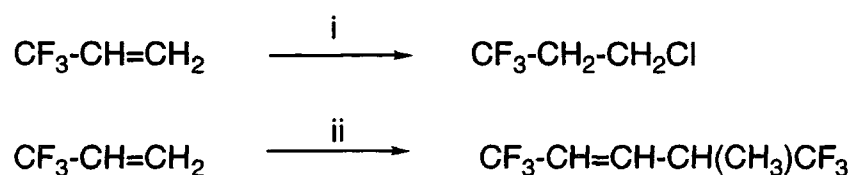

i) HCl, AlCl₃, 25°C.

ii) HSO₃F

Reiss has documented syntheses of alkenes with *two* fluoroalkyl substituents, and claims that such systems are essentially chemically inert.⁹⁶ Indeed, their use as potential blood substitutes is discussed.



i) a: 185°C, 48 hours.

b: KOH/EtOH, - HI

ii) HNEt₂, 120°C, 72 hours.

iii) R_F = C₄F₉, C₆F₁₃, C₈F₁₇

5.5.a. Bromination.

Bromination of (142) with elemental bromine proceeded slowly at room temperature, reflecting the reduced electron density of the double bond, and required 12 hours to achieve complete conversion to the 1,2-dibromide (149). This is comparable with previous observations.³⁷

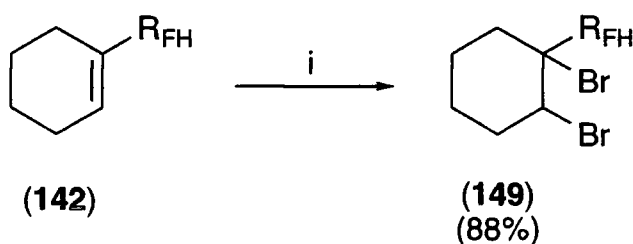

i) Br₂, DCM, room temperature, 12 hours.

ii) R_{FH} = CF₂CFHCF₃

Dibromide (149) is diastereomeric, and as a result the NMR spectra are complex with multiple signals arising from each nuclei. The positions of the difluoromethylene resonances in the ¹⁹F NMR spectrum do not alter to a large extent upon reaction, but a clear singlet at 4.65 ppm in the ¹H NMR spectrum is observed for the bromomethylene hydrogen atom. Furthermore, two signals for the bromomethylene carbon atom appear

in the ^{13}C NMR spectrum at 48.56 and 48.93 ppm (doublets, $^3J_{\text{CF}}$ 6.0 Hz) and similarly two signals for the fluoroalkylated carbon atom occur at 70.52 and 72.71 ppm (triplets, $^2J_{\text{CF}}$ 22.4 Hz).

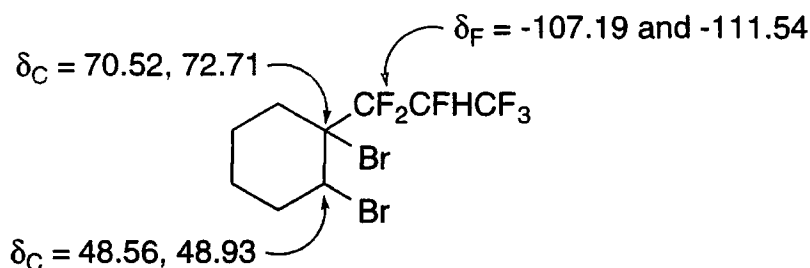

Characteristic NMR Chemical Shifts of (149).

Dibromide (149) displays two $[\text{M}-\text{Br}]^+$ ions at m/z 311 and 313 in its mass spectrum, these two peaks occurring in a 1:1 ratio that reflects the bromine isotope ratio.

Surprisingly, the polyfluoroalkylated cyclopentene analogue (143) reacted with elemental bromine to yield both the 1,2-dibromo compound (150) and the allylic bromide (151) after 12 hours at room temperature.

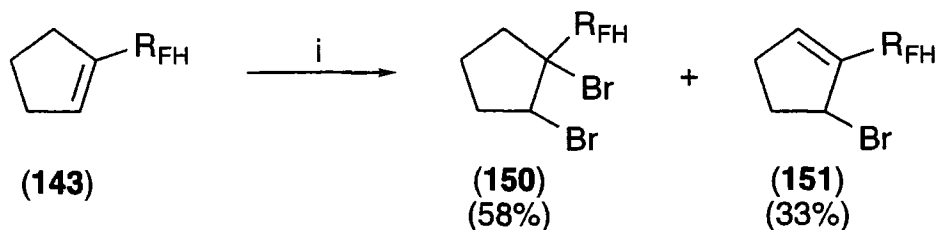

i) Br_2 , DCM, room temperature, 12 hours.

ii) $\text{R}_{\text{FH}} = \text{CF}_2\text{CFHCF}_3$

The 1,2-dibromide (150) was identified as above, its ^{13}C NMR spectrum showing two triplets at 73.87 and 74.83 ppm ($^2J_{\text{CF}} = 23.3$ Hz) and two multiplets at 52.82 and 53.37 ppm, corresponding to the quaternary and bromomethylene ring carbon atoms respectively. The mass spectrum (EI^+) displayed two $[\text{M}-\text{Br}]^+$ ions at m/z 297 and 299, in a 1:1 ratio.

Allylic bromide (151) was identified on the basis of its ^{13}C NMR spectrum, which displays two triplets at 138.42 ($^2J_{\text{CF}} = 26.6$ Hz) and 140.99 ppm ($^3J_{\text{CF}} = 7.6$ Hz), corresponding to the two unsaturated carbon atoms. Furthermore, the vinylic hydrogen atom is visible in the ^1H NMR spectrum as a singlet at 6.63 ppm, and the

bromomethylene hydrogen atom gives a multiplet at 5.11 ppm, confirming that the vinylic bromide is not formed.

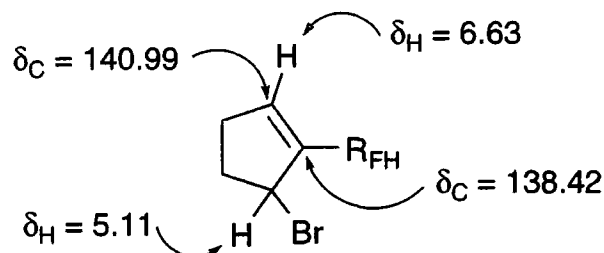

Characteristic NMR Chemical Shifts of (151).

GCMS of (151) shows a strong $[M-Br]^+$ ion at m/z 217, and production of the allylic bromide can be attributed to traces of base being present. Indeed, when carefully purified reagents were used the dibromo compound was produced in good yield (69%), only traces of other fluorinated materials being detected by ^{19}F NMR.

5.5.b. Epoxidation.

Alkenes (142) and (143) are both very slowly epoxidised by *meta*-chloro perbenzoic acid (mcpba),^{97, 98} the reaction requiring seven days at reflux (in DCM) to obtain quantitative conversions.

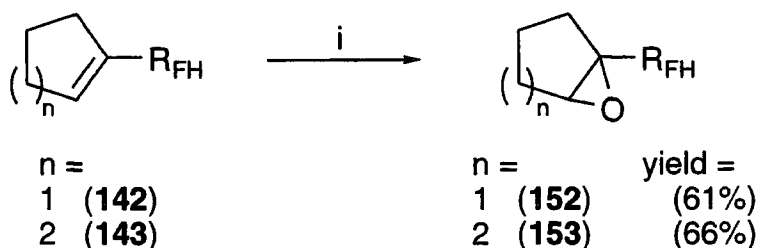

i) mcpba, DCM, reflux, 7 days.

ii) $R_{FH} = CF_2CFHCF_3$

Both epoxides are diastereomeric, and the ^{19}F NMR spectrum of (153) reflects this by displaying two signals for each of the fluoromethylene, difluoromethylene and trifluoromethyl groups. The 1H spectrum of (153) is complex but shows two resonances at 3.34 and 3.39 ppm, corresponding to the tertiary ring hydrogen atom, and the ^{13}C spectrum shows two signals for each of the two chiral centres adjacent to oxygen.

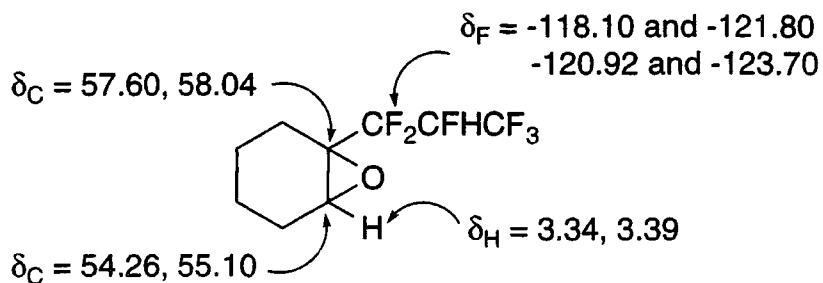

Characteristic NMR Chemical Shifts for (153).

GC of (153) shows two isomers, in a ratio of approx. 1:1, and the mass spectrum of each isomer shows a distinct $[M]^+$ ion at m/z 248. Epoxide (153) can be opened by the action of dilute acid,⁹⁹ producing the 1,2-diol (154) in good yield.

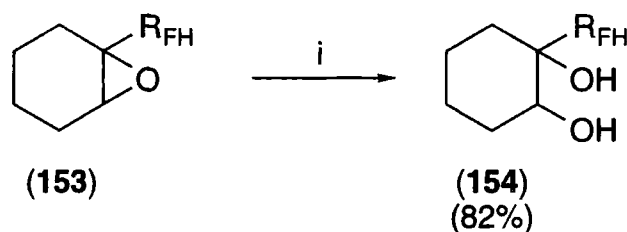

i) H_2SO_4/H_2O , 100°C, 12 hours.

ii) $R_{FH} = CF_2CFHCF_3$

It was mentioned (section 4.2.a.) that cyclohexane-1,2-diol itself is unreactive towards HFP under radical conditions, and this method hence provides an alternative route to polyfluoroalkylated 1,2-diols. Diol (154) is diastereomeric, and was identified by its ^{13}C NMR spectrum. Resonances at 67.54 and 69.20 ppm arise from the secondary hydroxyl carbon, and this is very close to the chemical shift of 70.01 ppm shown by the hydroxyl carbon atom in cyclohexanol. A triplet at 74.91 ppm ($^2J_{CF} = 22.4$ Hz) is attributable to the tertiary hydroxyl carbon atom, and this is very similar to the value of 73.84 ppm displayed by the cyclohexanol-HFP adduct (46).

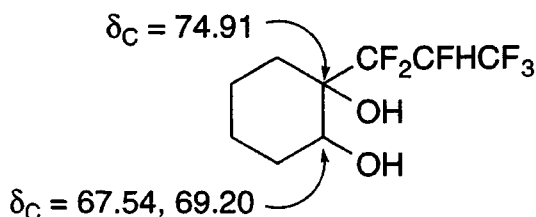

Characteristic NMR Chemical Shifts of (154).

5.5.c. Allylic Bromination.

Refluxing alkene (**142**) in carbon tetrachloride with two equivalents of N-bromo succinimide (NBS) and a catalytic amount of di-benzoyl peroxide gave the 3,6-dibromo compound (**155**) after 24 hours.¹⁰⁰

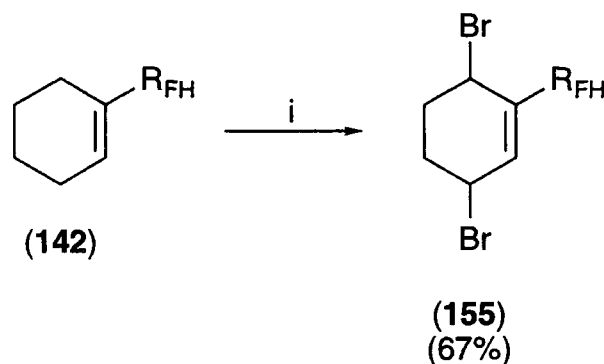

i) 2NBS, cat. (PhCO₂)₂, CCl₄, reflux, 24 hours.

ii) R_{FH} = CF₂CFHCF₃

Weak [M-Br]⁺ ion peaks occur at *m/z* 310 and 308 in the mass spectrum of (**155**), the 1:1 ratio observed corresponding to the isotopic distribution of bromine. More intense peaks occur at *m/z* 127 and 77, corresponding to the [PhCF₂]⁺ and [Ph]⁺ ions formed by dehydrobromination, and confirming that the *gem*-dibromide is not formed.

The NMR spectra of (**155**) are complex, but a singlet at 4.76 ppm in the ¹H NMR spectrum and a further group of singlets around 4.97 ppm can be assigned to the bromomethylene hydrogen atoms. A multiplet arising from the fluoromethylene hydrogen atom occurs at 5.02 ppm, and two broad singlets at 6.49 and 6.51 ppm can be attributed to the vinylic hydrogen nucleus. In the ¹³C NMR spectrum two triplets at 40.99 and 43.00 ppm (³J_{CF} 3.8 and 4.2 Hz respectively) arise from the bromomethylene carbon atom nearest the fluoroalkyl substituent, the remaining bromomethylene carbon nucleus giving two singlets at 42.87 and 48.60 ppm. Two low frequency triplets at 127.11 and 131.46 ppm (²J_{CF} = 24.3 and 23.3 Hz) correspond to the fluoroalkylated carbon atom, the other unsaturated carbon nucleus giving a further two low frequency triplets at 134.84 and 135.34 ppm (³J_{CF} = 7.9 and 6.4 Hz).

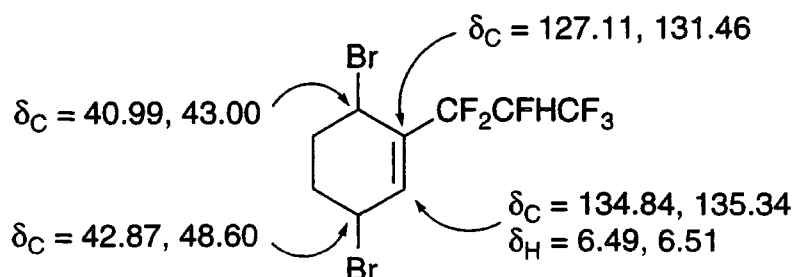

Characteristic NMR Chemical Shifts of (155).

A review of the literature has shown that lithium chloride in N,N-dimethyl formamide (DMF) is a useful dehydrohalogenating agent,^{37, 43, 101, 102} and indeed dibromide (155) can be dehydrobrominated by LiCl in DMF at 150°C to form hexafluoropropyl benzene (156).

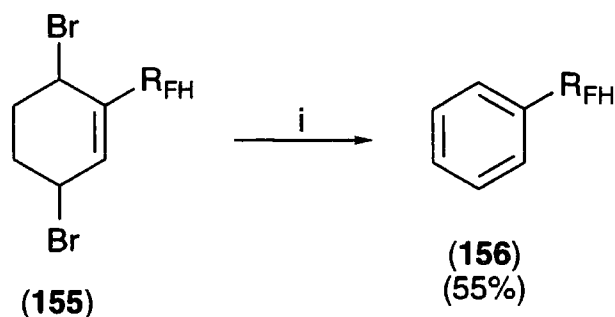

i) LiCl, DMF, 150°C, 24 hours.

ii) R_{FH} = CF₂CFHCF₃

Aromatic (156) gave strong peaks in the mass spectrum at m/z 228 and 127, corresponding to the [M]⁺ and [PhCF₂]⁺ ions respectively. Furthermore, the ¹H NMR spectrum showed only two resonances, in a 1:5 ratio. A doublet of multiplets occurs at 4.86 ppm (²J_{HF} 43.6 Hz), arising from the fluoromethylene hydrogen atom, and a complex multiplet occurs between 7.34 and 7.50 ppm, corresponding to the aromatic hydrogen nuclei. ¹³C NMR shows a triplet at 133.29 ppm (²J_{CF} 24.8 Hz), corresponding to the substituted aromatic carbon centre, and a triplet at 125.81 (³J_{CF} 6.1 Hz), arising from the *ortho* carbon nucleus. Singlets at 128.647 and 131.31 arise from the remaining two ring carbon atoms.

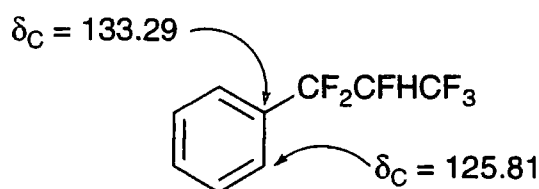

Characteristic NMR Chemical Shifts for (156).

This route to polyfluoroalkylated aromatics is an alternative to the more widely reported methodologies of fluoroalkyl-copper reagents^{103, 104} and the direct addition of fluoroalkyl radicals generated from fluoroalkyl halides^{105, 106}, fluoroalkylcarboxylic acids¹⁰⁷ or hexafluoroacetone.^{108, 109}

Surprisingly, if an excess of NBS is used to brominate (142) the *ortho*-bromo aromatic (157) is obtained directly.

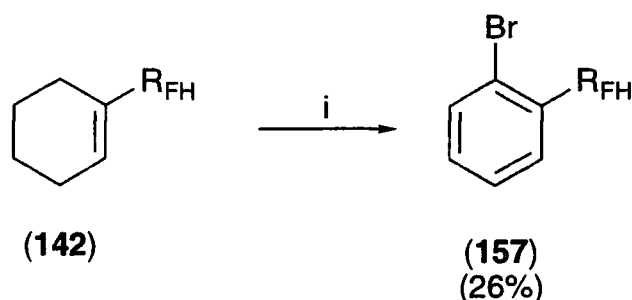

i) xs NBS, $(\text{PhCO}_2)_2$, CCl_4 , reflux, 24 hours.

ii) $\text{R}_{\text{FH}} = \text{CF}_2\text{CFHCF}_3$

The ^{19}F NMR spectrum of (157) shows three resonances (section 2.2.a.), a singlet (relative intensity 3), an AB quartet (relative intensity 2) and a doublet of multiplets (relative intensity 1), confirming that the structure of the fluorinated side chain is unaltered. Furthermore, the mass spectrum contains two strong $[\text{M}]^+$ ions in a 1:1 ratio, at m/z 306 and 308, confirming the incorporation of a single bromine atom which must hence be an aromatic substituent. The *ortho* configuration of (157) was determined by a comparison of the ^1H and ^{13}C NMR spectra to those of the commercially available *ortho*- and *meta*-bromo- α,α,α -trifluorotoluenes (table 5.5.c.i.)

Compound.	¹ H NMR Signals. ^a (relative intensity, multiplicity, ^b coupling constant ^c)	¹³ C NMR Signals. ^a (multiplicity, ^b coupling constant ^c)
 (158)	7.34 (1H, t, ³ J _{HH} 8.0), 7.56 (1H, d, ³ J _{HH} 8.0), 7.67 (1H, d, ³ J _{HH} 8.0), 7.79 (1H, s)	122.71 (s), 123.84 (q, ³ J _{CF} 3.8), 128.51 (q, ³ J _{CF} 3.8), 130.31 (s), 132.44 (q, ² J _{CF} 32.8), 134.93(s)
 (159)	7.39 (2H, m), 7.70 (2H, m)	119.94 (q, ³ J _{CF} 1.9), 127.24 (s), 127.71 (q, ³ J _{CF} 5.3), 130.08 (q, ² J _{CF} 30.9), 131.96 (s), 134.86(s)
 (157)	7.37 (1H, t, ³ J _{HH} 8.0), 7.48 (1H, d, ³ J _{HH} 8.0), 7.69 (2H, m)	122.76 (s), 124.58 (t, ³ J _{CF} 7.1), 129.07 (t, ³ J _{CF} 5.0), 130.29 (s), 133.46 (t, ² J _{CF} 25.4), 134.55(s)

Table 5.5.c.i. ¹H and ¹³C NMR Chemical Shifts of Disubstituted Aromatics.

a) Excluding side chain nuclei. Values in ppm.

b) s = singlet, d = doublet, t = triplet, q = quartet, m = multiplet.

c) Values in Hz.

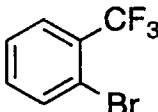
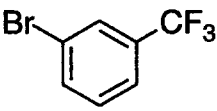
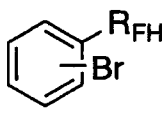
Both the ¹H and ¹³C spectra of **(157)** show distinct similarities to those of the *ortho*-bromo aromatic **(158)**, the major difference being that coupling to the difluoromethylene group in **(157)** gives rise to triplets in the ¹³C NMR spectrum for the aromatic carbon atoms, whilst the analogous resonances in **(158)** give quartets due to the presence of three magnetically equivalent fluorine atoms.

5.6. Alkene Dehydrofluorination.

Polyfluoroalkylated cyclopentene **(143)** is dehydrofluorinated rapidly by the action of powdered potassium hydroxide to give the diene **(159)**.

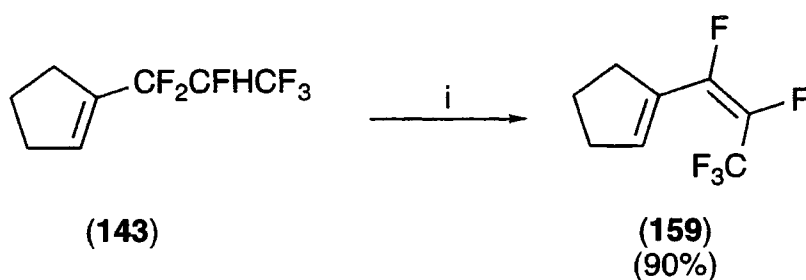

i) KOH, 25°C, 30 mins.

The reaction is conveniently monitored by ^{19}F NMR, and the spectrum of **(159)** displays three signals in a 3:1:1 ratio. These signals occur at -64.11, -120.37 and -155.28 ppm respectively, and the $^3J_{\text{FF}}$ coupling constant between the two vinylic fluorine atoms is small, both resonances appearing as unresolved multiplets. Diene **(159)** is thus identified as having the Z-conformation about the fluorinated double bond, as was predicted by the arguments in section 5.3.b. The ^1H NMR spectrum of **(159)** contains a doublet ($^4J_{\text{HF}} = 2.0$ Hz) at 6.30 ppm, arising from the vinylic hydrogen atom, and the ^{13}C spectrum displays four low frequency resonances corresponding to the four unsaturated carbon nuclei.

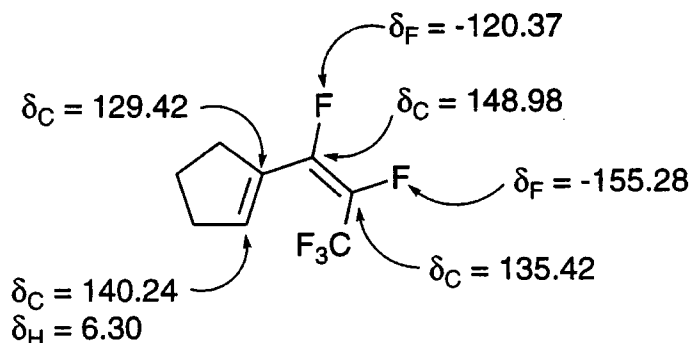

Characteristic NMR Chemical Shifts of **(159)**.

The mass spectrum of **(159)** displays a very strong $[\text{M}]^+$ ion at m/z 198, and the cyclohexene derivative **(142)** similarly dehydrofluorinates on contact with potassium hydroxide, again forming the Z-double bond as determined by ^{19}F NMR.

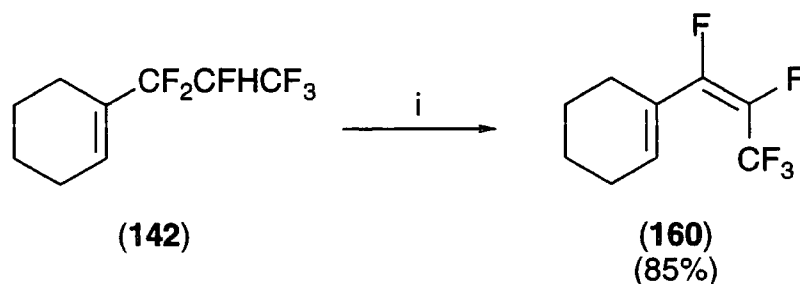

i) KOH, 25°C, 30mins.

Diene (**160**) was characterised as above, having a small $^3J_{FF}$ coupling constant between the two vinylic fluorine atoms and displaying a strong $[M]^+$ ion in the mass spectrum at m/z 212. The dehydrated cyclic fluoroalkene adducts discussed in section 5.4. may be dehydrofluorinated using the same methodology.

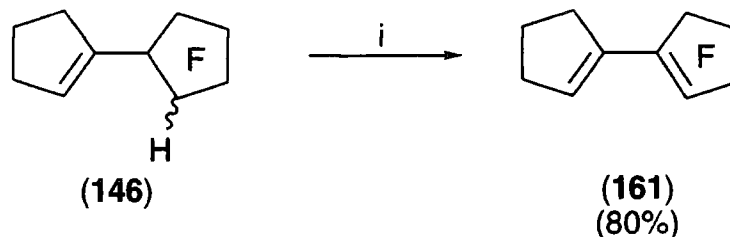

i) KOH, 25°C, 30mins.

The mass spectrum of diene (**161**) shows a strong $[M]^+$ ion at m/z 260, but the ^{19}F NMR spectrum was dramatically different from that of the *cis* and *trans* isomeric mixture of starting materials (section 4.5.b), showing just four singlets in a 2:2:2:1 ratio. Two chiral centres have been removed from the fluorinated ring of (**146**) during dehydrofluorination, and each fluorine atom of the difluoromethylene groups in (**161**) now occupy, on average, equivalent surroundings. The ^{13}C spectrum of (**161**) contains three low field methylene carbon singlets, a complex multiplet arising from the three difluoromethylene carbon atoms and four low frequency signals corresponding to the unsaturated carbon nuclei. 1H NMR gives a clear singlet at 6.56 ppm arising from the vinylic hydrogen atom.

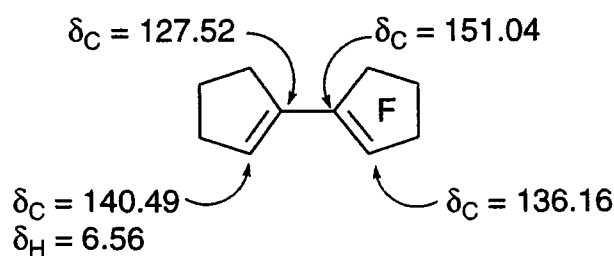

Characteristic NMR Chemical Shifts for (**161**).

Only traces of the isomeric dehydrofluorination product (**162**) were detected, and the mass spectrum of this minor product was dissimilar to that of diene (**161**), containing only a weak $[M]^+$ ion at m/z 260 but displaying a strong cyclopentyl ion at m/z 67.

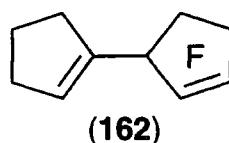

Diene (**162**) contains a chiral centre, and therefore two AB quartets are seen for the four difluoromethylene fluorine nuclei in the ^{19}F NMR spectrum. Three multiplets arising from the tertiary and vinylic fluorine atoms can be seen between -135 and -160 ppm.

5.7. Diene Reactivity.

It has been mentioned that fluorine-substituted alkenes are electrophilic, and their reactions with nucleophiles are well documented.² Diene (**159**) reacted with a range of oxygen nucleophiles (generated *in situ* from the analogous primary alcohols and KOH) selectively at the fluorinated double bond to form the corresponding enol ethers.

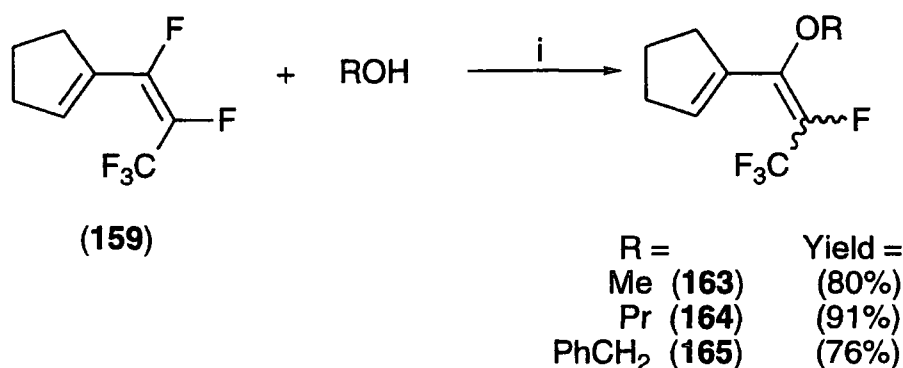

i) KOH, 25°C, 12 hours

Sterically more demanding alcohols, such as *iso*-propanol or phenol, gave no reaction under similar conditions. The mass spectrum of the methyl enol-ether (**163**) contained a large $[\text{M}]^+$ ion at m/z 210, and the ^{19}F NMR spectrum showed only two singlets at -63.93 and -156.56 ppm (3:1 ratio), indicating that it is the vinylic fluorine atom furthest from trifluoromethyl that is replaced by the nucleophile (section 5.2.b.). This site of attack would be predicted from the electronic and polar effects outlined in section 1.3.d.

The simplicity of the ^{19}F NMR data indicates that only one regioisomer of the enol ether (**163**) is formed, but does not indicate the geometry of the fluorine and trifluoromethyl groups. ^1H NMR shows high frequency resonances for the six ring hydrogen atoms, and a singlet for the three methyl hydrogen nuclei appears at 3.65 ppm. The vinylic hydrogen atom occurs at 6.02 ppm. The ^{13}C spectrum contains a resonance at 57.01 ppm, corresponding to the methyl carbon nucleus, and this occurs as a doublet with $^4J_{\text{CF}}$ 2.6 Hz. Unfortunately, literature data for such $^4J_{\text{CF}}$ couplings is scarce, but $^4J_{\text{HF}}$ couplings within similar systems have been documented.⁷²

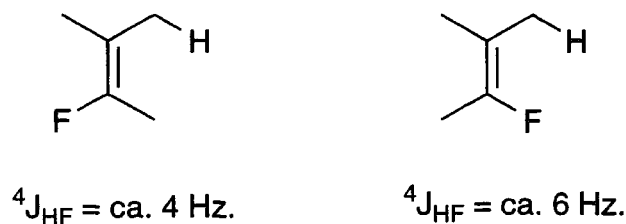

As ${}^4J_{\text{HF}}$ coupling constants tend to lie between 0 and 8 Hz, and ${}^4J_{\text{CF}}$ couplings between 0 and 5 Hz (section 2.2.a.), this implies that the methoxy and fluorine substituents are *trans*. A further four resonances occur at low frequency corresponding to the four unsaturated carbon atoms.

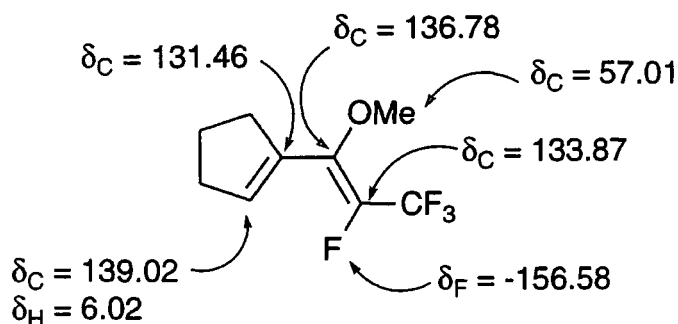

Characteristic NMR Chemical Shifts of (163).

The propyl- (164) and benzyl enol ethers (165) were characterised in a similar manner, each nucleophile reacting at the same site in the diene (159).

The ring double bond reacts preferentially with electrophilic reagents, and refluxing diene (160) with mcpba gave the epoxide (166) after 7 days.

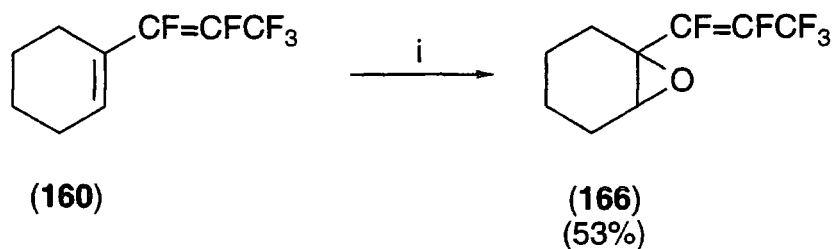

i) mcpba, DCM, reflux, 7 days.

Epoxide (166) displays peaks at m/z 228 and 159 in its mass spectrum, corresponding to the $[\text{M}]^+$ and $[\text{M}-\text{CF}_3]^+$ ions respectively. The ${}^{19}\text{F}$ NMR spectrum shows three multiplets, the ${}^3J_{\text{FF}}$ coupling constant between the two vinylic fluorine atoms being approx. 6 Hz and indicating that the *Z*-configuration of the fluorinated double bond is

retained. A singlet at 58.83 ppm and a doublet ($^2J_{CF} = 25.5$ Hz) at 54.02 ppm in the ^{13}C NMR spectrum correspond to the two carbon atoms adjacent to oxygen, and the ^1H spectrum shows a singlet at 3.32 ppm, arising from the tertiary hydrogen atom.

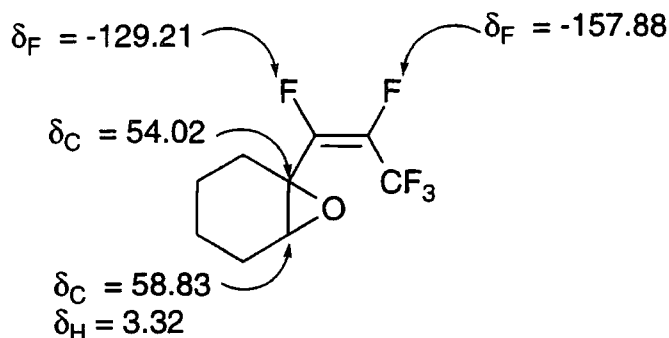

Characteristic NMR Chemical Shifts for (166).

Traces of the diepoxide (167) were detected, the mass spectrum displaying a clear $[\text{M}-\text{CF}_3]^+$ ion at m/z 175, but could not be isolated. The ^{19}F NMR spectrum shows two sets of three signals, reflecting the diastereomeric nature of (167), and doublets with a $^3J_{\text{FF}}$ coupling constant of approx. 30 Hz arise from the two tertiary fluorine atoms.

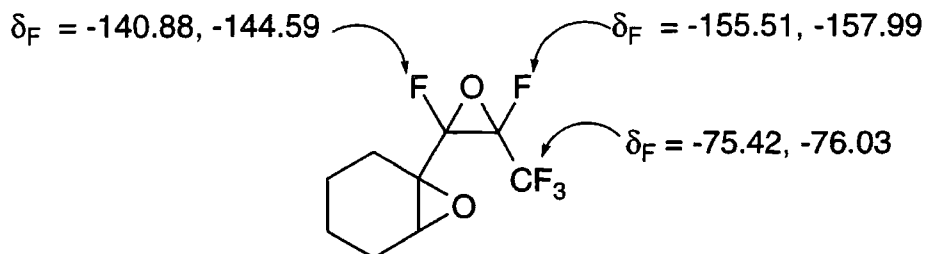

Characteristic NMR Chemical Shifts for (167).

5.8. Conclusions.

- Alcohol-HFP adducts can be dehydrofluorinated by potassium hydroxide or alkoxide bases to give the E- allylic alcohols in good yield *via* an intramolecular isomerisation from the Z- allylic alcohols, and the mechanism of dehydrofluorination has been discussed.

- The adducts can be functionalised at oxygen, and dehydration gives polyfluoroalkylated alkenes which have reduced nucleophilicity.

- Dehydrofluorination of the above alkenes yields dienes with the Z-configuration about the fluorinated double bond, and an investigation into the reactions of the dienes has begun.

Instrumentation.

Reagents and Solvents.

All chemicals were used as received from suppliers unless stated otherwise. Solvents were dried by standard methods and stored over molecular sieves (4Å).

Gas Liquid Chromatography.

Chromatographic analyses were performed on a Hewlett Packard 5890 Series II gas liquid chromatograph equipped with a 25m cross-linked methyl silicone capillary column. Preparative scale GC was performed on a Varian Aerograph Model 920 gas chromatograph (catharometer detector), fitted with a 3m 10% SE30 packed column.

Distillation / Boiling Points / Melting Points.

Fractional distillation was performed using a Fischer Spaltrohr MMS255 small concentric tube apparatus. Boiling points were either recorded during distillation or carried out at atmospheric pressure (Siwoboloff's method) using a Gallankamp apparatus, and are uncorrected. Melting points were carried out at atmospheric pressure using the Gallankamp apparatus and are also uncorrected.

Elemental Analyses.

Carbon and hydrogen elemental analyses were obtained using a Perkin-Elmer 240 Elemental Analyser or a Carlo Erba Strumentazione 1106 Elemental Analyser.

NMR Spectra.

¹H spectra were obtained from either a Bruker AC250 spectrometer (250.13 MHz) or a Varian VXR400S spectrometer (399.96 MHz), and all the following data is quoted from the latter unless stated. ¹³C spectra were recorded on the Varian spectrometer (100.58 MHz), and ¹⁹F spectra were obtained on either the Bruker spectrometer (235.34 MHz) or the Varian spectrometer (376.29 MHz), again with all data being quoted from the latter unless stated. All spectra were recorded with TMS and/or CFCl₃ as internal references, and J values are given in Hz.

Mass Spectra.

Mass spectra were obtained from a VG Trio 1000 Mass Spectrometer (electronic ionization) coupled to a GC apparatus as above. Accurate mass

determinations were performed on a Micromass Autospec Mass Spectrometer or at the EPSRC National Mass Spectroscopy Service, University of Wales, Swansea.

FT-IR Spectra.

Infrared spectra were recorded on a Perkin-Elmer 1600 FT-IR spectrometer using thin films between KBr or NaCl plates, as either neat liquids or as Nujol mulls.

Chapter 6: Experimental to Chapter 2.

γ-ray Initiated Reactions.

A Pyrex Carius tube (vol. *ca.* 70 ml) was charged with the solid or liquid reactants and solvent, and the resulting mixture was degassed three times by freeze-thawing under vacuum. The fluoroalkene was degassed separately by the same procedure and transferred to the tube at reduced pressure using standard vacuum line techniques. The Carius tube was sealed whilst frozen and allowed to reach room temperature in a metal sheath, after which time it was housed in a purpose built irradiation chamber and irradiated with γ -rays from a ^{60}Co source for a period of ten days (*ca.* 15 MRads). The tube was then removed from the chamber, frozen in liquid air and opened. Volatiles were trapped as the tube approached room temperature, and the product solutions were collected and purified by either fractional distillation at reduced pressure (Spaltrohr) or column chromatography over silica gel.

Peroxide Initiated Reactions.

An autoclave (vol. *ca.* 50, 100 or 500 ml), fitted with a bursting disc (maximum working pressure approx. 200 bar) was charged with the solid or liquid reactants and peroxide and sealed using a copper gasket. The resulting mixture was degassed three times by freeze-thawing under vacuum, and the fluoroalkene was degassed separately by the same procedure and transferred to the autoclave at reduced pressure using standard vacuum line techniques. The autoclave valve was closed and the reaction vessel was transferred to a purpose built chamber where it was allowed to reach room temperature before being heated to 140 °C for 24 hours in a thermostatically controlled rocking furnace. After this period the autoclave was cooled to ambient temperature, removed from the chamber, frozen in liquid air and the valve was opened. Volatiles were trapped as the autoclave approached room temperature, and the autoclave was then opened and the product solutions collected and purified as described above.

Cyclohexanol with hexafluoropropene (γ -ray initiation).

Cyclohexanol (12.5 g, 125 mmol), acetone (20 ml) and HFP (22.0 g, 147 mmol) gave 1-(1,1,2,3,3,3-hexafluoropropyl)-cyclohexanol (**46**)³⁷ (23.8 g, 76%) as colourless crystals after fractional distillation at reduced pressure. mp 42–43 °C; bp (9 mm Hg) 59 °C; (Found: C, 43.3; H, 4.8. $\text{C}_9\text{H}_{12}\text{F}_6\text{O}$ requires C, 43.3; H, 4.8%); NMR spectrum no. 1; Mass spectrum no. 1; IR spectrum no. 1.

(Compounds with a reference number, (X)^x, indicate that the species has been mentioned in that reference.)

Cyclohexanol with hexafluoropropene (peroxide initiation).

Cyclohexanol (75.0 g, 0.75 mol), di-*tert*-butyl peroxide (5.9 g, 0.04 mol) and HFP (120.1 g, 0.80 mol) gave **(46)** (122.5 g, 65%) as described previously after fractional distillation at reduced pressure.

Cyclobutanol with hexafluoropropene (γ -ray initiation).

Cyclobutanol (5.0 g, 69 mmol), acetone (20 ml) and HFP (12.0 g, 80 mmol) gave 1-(1,1,2,3,3,3-hexafluoropropyl)-cyclobutanol (**52**) (12.0 g, 78%) as a colourless liquid after fractional distillation at reduced pressure. bp (16 mm Hg) 44-46 °C; (Found: C, 37.8; H, 3.5. C₇H₈F₆O requires C, 37.8; H, 3.6%); NMR spectrum no. 2; Mass spectrum no. 2; IR spectrum no. 2.

Cyclopentanol with hexafluoropropene (γ -ray initiation).

Cyclopentanol (4.8 g, 56 mmol), acetone (20 ml) and HFP (9.6 g, 64 mmol) gave 1-(1,1,2,3,3,3-hexafluoropropyl)-cyclopentanol (**54**)³⁷ (9.5 g, 72%) as a colourless liquid after fractional distillation at reduced pressure. bp (4 mm Hg) 37-38 °C; (Found: C, 40.7; H, 4.3. C₈H₁₀F₆O requires C, 40.7; H, 4.2%); NMR spectrum no. 3; Mass spectrum no. 3; IR spectrum no. 3.

Cycloheptanol with hexafluoropropene (γ -ray initiation).

Cycloheptanol (13.0 g, 114 mmol), acetone (20 ml) and HFP (20.1 g, 134 mmol) gave 1-(1,1,2,3,3,3-hexafluoropropyl)-cycloheptanol (**56**)³⁷ (20.5 g, 68%) as a colourless liquid after fractional distillation at reduced pressure. bp (5 mm Hg) 64-67 °C; (Found: C, 45.4; H, 5.3. C₁₀H₁₄F₆O requires C, 45.5; H, 5.3%); NMR spectrum no. 4; Mass spectrum no. 4; IR spectrum no. 4.

Cyclopentanol with hexafluoropropene (peroxide initiation).

Cyclopentanol (65.0 g, 0.76 mol), di-*tert*-butyl peroxide (5.9 g, 0.04 mol) and HFP (120.0 g, 0.80 mol) gave **(54)** (117.2 g, 65%) as described previously after fractional distillation at reduced pressure.

Competition reactions for hexafluoropropene.

Cyclopentane and cyclopentanol (γ -ray initiation).

Cyclopentane (2.5 g, 36 mmol), cyclopentanol (5.5 g, 64 mmol), acetone (20 ml) and HFP (3.7 g, 25 mmol) were irradiated to the usual dosage. By GC, the composition of the mixture of reactants prior to reaction was 35.74% and 64.26% respectively, and after reaction was 27.89% and 47.47%. The relative conversions of the two species were calculated to be 21.96% and 26.13% respectively.

Cyclopentanol, cyclohexanol and cycloheptanol (γ -ray initiation).

Cyclopentanol (2.5 g, 29 mmol), cyclohexanol (3.6 g, 36 mmol), cycloheptanol (3.9 g, 34 mmol), acetone (20 ml) and HFP (3.5 g, 23 mmol) were irradiated to the usual dosage. By GC, the composition of the mixture of alcohols prior to reaction was 29.26%, 36.51% and 34.23% respectively, and after reaction was 22.77%, 28.98% and 27.26%. The relative conversions of the three alcohols were calculated to be 22.18%, 20.62% and 20.36% respectively.

Cyclooctanol with hexafluoropropene (γ -ray initiation).

Cyclooctanol (14.2 g, 111 mmol), acetone (20 ml) and HFP (19.2 g, 128 mmol) gave *1-(1,1,2,3,3,3-hexafluoropropyl)-cyclooctanol* (**61**) (5.6 g, 18%); bp 198-200 °C; (Found: m/z $[M-R_{FH}]^+$, 127.1123. $C_{11}H_{16}F_6O$ requires m/z $[M-R_{FH}]^+$, 127.1123) (>95% pure by GC, traces of decomposition products prohibit elemental analysis); NMR spectrum no. 5; Mass spectrum no. 5; IR spectrum no. 5; and a mixture of compounds whose data was consistent with *1,x-di-(1,1,2,3,3,3-hexafluoropropyl)-cyclooctanol* (**62**) ($x=3-5$) (19.0 g, 40%) as colourless liquids after over silica gel (DCM); Mass spectrum no. 6.

Cyclodecanol with hexafluoropropene (γ -ray initiation).

Cyclodecanol (5.0 g, 32 mmol) acetone (20 ml) and HFP (5.5 g, 37 mmol) gave two compounds that could not be isolated but whose data was consistent with *1-(1,1,2,3,3,3-hexafluoropropyl)-cyclodecanol* (**64**); Mass spectrum no. 7; and *1,x-di-(1,1,2,3,3,3-hexafluoropropyl)-cyclodecanol* ($x=3-6$); Mass spectrum no. 8; (10% and 11% respectively by GC ratios).

Cyclododecanol with hexafluoropropene (γ -ray initiation).

Cyclododecanol (5.5 g, 29 mmol), acetone (20 ml) and HFP (5.0 g, 33 mmol) gave two compounds that could not be isolated but whose data was consistent with *1-(1,1,2,3,3,3-hexafluoropropyl)-cyclododecanol* (**66**); Mass spectrum no. 9; and *1,x-di-(1,1,2,3,3,3-hexafluoropropyl)-cyclododecanol* ($x=3-7$); Mass spectrum no. 10; (9% and 13% respectively by GC ratios).

Cyclodecanol with hexafluoropropene (peroxide initiation).

Cyclodecanol (5.0 g, 32 mmol), di-*tert*-butyl peroxide (0.6 g, 4 mmol) and HFP (5.5 g, 37 mmol) gave (**64**) and *1,x-di-(1,1,2,3,3,3-hexafluoropropyl)-cyclodecanol* ($x=3-6$) (19% and 7% respectively) as described previously.

Chapter 7. Experimental to Chapter 3.

General procedure for both γ -ray and peroxide initiated reactions described in Chapter 6.

Cyclohexanol with hexafluoropropene in trifluoroethanol (γ -ray initiation).

Cyclohexanol (11.0 g, 110 mmol), trifluoroethanol (20 ml) and HFP (18.9 g, 126 mmol) gave (46) (21.5 g, 78%) as described previously after fractional distillation at reduced pressure.

Trans-4-methylcyclohexanol with hexafluoropropene (γ -ray initiation).

Trans-4-methylcyclohexanol (10.0 g, 88 mmol), acetone (20 ml) and HFP (15.1 g, 101 mmol) gave 1-(1,1,2,3,3,3-hexafluoropropyl)-4-methylcyclohexanol (68)³⁷ (16.9 g, 73%) as a colourless liquid; bp 60-62 °C; (Found: m/z [M-OH]⁺, 245.0763. C₁₀H₁₄F₆O requires m/z [M-OH]⁺, 245.0765) (>95% pure by GC, traces of decomposition products prohibits elemental analysis); NMR spectrum no. 6; Mass spectrum no. 11; IR spectrum no. 6; and 1,4-di-(1,1,2,3,3,3-hexafluoropropyl)-4-methylcyclohexanol (69) (1.5 g, 4%) as a colourless solid; mp 70-71 °C; (Found: C, 37.7; H, 3.4. C₁₃H₁₄F₁₂O requires C, 37.7; H, 3.4%); NMR spectrum no. 7; Mass spectrum no. 12; X-ray crystal structure no. 1; after column chromatography over silica gel (DCM).

Cis-4-methylcyclohexanol with hexafluoropropene (γ -ray initiation).

Cis-4-methylcyclohexanol (10.0 g, 88 mmol), acetone (20 ml) and HFP (15.0 g, 100 mmol) gave (68) (15.9 g, 68%) and (69) (1.1 g, 3%) as described previously after column chromatography over silica gel (DCM).

4-Tert-butylcyclohexanol with hexafluoropropene (γ -ray initiation).

4-*Tert*-butylcyclohexanol (5.0 g, 32 mmol), trifluoroethanol (20 ml) and HFP (5.5 g, 37 mmol) gave 1-(1,1,2,3,3,3-hexafluoropropyl)-4-*tert*-butylcyclohexanol (71) (6.9 g, 70%) as a colourless solid after column chromatography over silica gel (DCM). mp 90-91 °C; (Found: C, 51.1; H, 6.6. C₁₃H₁₉F₆O requires C, 51.0; H, 6.5%); NMR spectrum no. 8; Mass spectrum no. 13; IR spectrum no. 7; X-ray crystal structure no. 2.

Trans-2-methylcyclohexanol with hexafluoropropene (γ -ray initiation).

Trans-2-methylcyclohexanol (5.0 g, 44 mmol), acetone (20 ml) and HFP (7.5 g, 50 mmol) gave *trans*-2-(2,2,3,4,4,4-hexafluorobutyl)-1-(1,1,2,3,3,3-hexafluoropropyl)-cyclohexanol (73) (1.8 g, 10%) as a colourless oil after column chromatography over silica gel (9:1, DCM:Ethyl acetate). bp 185-187 °C; (Found: m/z [M-H₂O]⁺, 396.0747. C₁₃H₁₄OF₁₂ requires m/z [M-H₂O]⁺, 396.0747) (>90% pure by GC, decomposition products prohibit elemental analysis); NMR spectrum no. 9; Mass spectrum no. 14; IR spectrum no. 8.

Iso-menthol with hexafluoropropene (γ -ray initiation).

Iso-menthol (9.4 g, 60 mmol), acetone (20 ml) and HFP (10.4 g, 69 mmol) showed no reaction as determined by ^{19}F NMR.

Iso-menthol with hexafluoropropene (peroxide initiation).

Iso-menthol (20.0 g, 128 mmol), HFP (22.2 g, 148 mmol) and di-*tert*-butyl peroxide (0.9 g, 6 mmol) showed no reaction as determined by ^{19}F NMR.

Exo-norborneol with hexafluoropropene (γ -ray initiation).

Exo-norborneol (2.7 g, 24 mmol), acetone (20 ml) and HFP (4.2 g, 28 mmol) gave *exo-2-(1,1,2,3,3,3-hexafluoropropyl)-norbornan-2-ol* (**77**) (3.4 g, 54%); bp 184-186 °C; (Found: m/z $[\text{M}]^+$, 262.0781. $\text{C}_{10}\text{H}_{12}\text{OF}_6$ requires m/z $[\text{M}]^+$, 262.0792) (>90% pure by GC, decomposition products prohibit elemental analysis); NMR spectrum no. 10; Mass spectrum no. 15; I.R. spectrum no. 9; and a compound that could not be isolated by column chromatography or fractional distillation but whose data was consistent with *2,x-di-(1,1,2,3,3,3-hexafluoropropyl)-norbornan-2-ol* (**78**) ($x=1, 3-7$) (11% by GC); Mass spectrum no. 16.

Competition reaction for hexafluoropropene.

Cyclohexanol and exo-norborneol (γ -ray initiation).

Cyclohexanol (3.0 g, 30 mmol), *exo-norborneol* (3.4 g, 30 mmol), acetone (20 ml) and HFP (2.3 g, 15 mmol) were irradiated to the usual dosage. By GC, the composition of the mixture of alcohols prior to reaction was 42.75% and 57.25% respectively, and after reaction was 16.30% and 37.13%. The relative conversions of the two alcohols were calculated to be 61.87% and 35.14% respectively.

Decahydronaphthan-1-ol with hexafluoropropene (γ -ray initiation).

Decahydronaphthan-1-ol (4.4 g, 28 mmol), acetone (20 ml) and HFP (5.0 g, 33 mmol) gave a compound that could not be separated from the starting material (conversion of HFP ca. 10%) but whose data (section 3.8.) was consistent with *1,8-di-(1,1,2,3,3,3-hexafluoropropyl)-decahydronaphthan-1-ol* (**79**); NMR spectrum no. 11; Mass spectrum no. 17.

Decahydronaphthan-1-ol with hexafluoropropene (peroxide initiation).

Decahydronaphthan-1-ol (8.8 g, 56 mmol), HFP (12.1 g, 81 mmol) and di-*tert*-butyl peroxide (0.8 g, 5 mmol) gave a compound whose data was consistent with (**79**) as detailed previously (conversion of HFP ca. 40%).

Decahydronaphtan-2-ol with hexafluoropropene (γ -ray initiation).

Decahydronaphtan-2-ol (44 g, 28 mmol), acetone (20 ml) and HFP (5.1 g, 34 mmol) gave two compounds that could not be fully separated from the starting material (conversion of HFP ca. 45%) but whose data (section 3.8.) was consistent with 2-(1,1,2,3,3,3-hexafluoropropyl)-decahydronaphtan-2-ol (**81**); NMR spectrum no. 12; Mass spectrum no. 18; and 2,x-di-(1,1,2,3,3,3-hexafluoropropyl)-decahydronaphtan-2-ol ; Mass spectrum no. 19.

3- β -Cholestanol with hexafluoropropene (γ -ray initiation).

3- β -cholestanol (5.4 g, 14 mmol), acetone (20 ml) and HFP (2.4 g, 16 mmol) gave traces of a mono-adduct x-(1,1,2,3,3,3-hexafluoropropyl)-3- β -cholestanol (**83**) by ^{19}F NMR but which could not be separated from the starting material .

Chapter 8. Experimental to Chapter 4.

General procedure for both γ -ray and peroxide initiated reactions described in Chapter 6.

Cyclohexane-1,4-diol with hexafluoropropene (γ -ray initiation).

Cyclohexane-1,4-diol (2.5 g, 22 mmol), acetone (20 ml) and HFP (7.5 g, 50 mmol) gave 1,4-di-(1,1,2,3,3,3-hexafluoropropyl)-cyclohexane-1,4-diol (**85**)³⁷ (7.6 g, 83%) as colourless crystals after column chromatography over silica gel (Ethyl acetate). mp 105-107 °C; (Found: C, 34.8; H, 2.9. C₁₂H₁₂F₁₂O₂ requires C, 34.6; H, 2.9%); NMR spectrum no. 13; Mass spectrum no. 20; IR spectrum no. 10.

Cyclohexane-1,3-diol with hexafluoropropene (γ -ray initiation).

Cyclohexane-1,3-diol (2.5 g, 22 mmol), acetone (20 ml) and HFP (7.5 g, 50 mmol) gave 1-(1,1,2,3,3,3-hexafluoropropyl)-cyclohexane-1,3-diol (**87**)³⁷ (1.8 g, 30%); mp 58-59 °C; (Found: m/z [M-H₂O-HF]⁺, 228.0569. C₉H₁₂F₆O₂ requires m/z [M-H₂O-HF]⁺, 228.0574) (>90% pure by GC, decomposition products prohibit elemental analysis); NMR spectrum no. 14; Mass spectrum no. 21; IR spectrum no. 11; and 1,3-di-(1,1,2,3,3,3-hexafluoropropyl)-cyclohexane-1,3-diol (**88**)³⁷ (4.1 g, 45%); mp 84-86 °C; (Found: C, 34.9; H, 2.8. C₁₂H₁₂F₁₂O₂ requires C, 34.6; H, 2.9%); NMR spectrum no. 15; Mass spectrum no. 22; IR spectrum no. 12 as colourless crystals after column chromatography over silica gel (Ethyl acetate).

Cyclohexane-1,2-diol with hexafluoropropene (γ -ray initiation).

Cyclohexane-1,2-diol (6.5 g, 56 mmol), acetone (20 ml) and HFP (20.0 g, 133 mmol) showed no reaction as determined by ¹⁹F NMR.

Cyclohexane-1,2-diol with hexafluoropropene (peroxide initiation).

Cyclohexane-1,2-diol (8.3 g, 72 mmol), HFP (25.4 g, 169 mmol) and di-*tert*-butyl peroxide (0.9 g, 6 mmol) showed no reaction as determined by ¹⁹F NMR.

Competition reaction for hexafluoropropene.

Cyclohexane-1,4-diol and cyclohexane-1,2-diol (γ -ray initiation).

Cyclohexane-1,4-diol (2.0 g, 17 mmol), cyclohexane-1,2-diol (2.0 g, 17 mmol), acetone (20 ml) and HFP (4.0 g, 27 mmol) were irradiated to the usual dosage. By GC, the composition of the mixture of reactants prior to reaction was 48.36% and 51.64% respectively, and after reaction was 20.90% and 51.60%. The relative conversions of the two species were calculated to be 43.22% and 00.08% respectively.

Cyclohexane-1,3,5-triol with hexafluoropropene (γ -ray initiation).

Cyclohexane-1,3,5-triol (5.0 g, 38 mmol), acetone (20 ml) and HFP (20.2 g, 135 mmol) showed no reaction as determined by ^{19}F NMR.

Cyclopentane-1,3-diol with a deficiency of hexafluoropropene (γ -ray initiation).

Cyclopentane-1,3-diol (5.0 g, 49 mmol), acetone (20 ml) and HFP (7.3 g, 49 mmol) gave a mixture of two compounds which could not be separated (ratio ca. 1:2) but whose data are consistent with *1-(1,1,2,3,3,3-hexafluoropropyl)-cyclopentane-1,3-diol*; Mass spectrum no. 23 and 1,3-di-(1,1,2,3,3,3-hexafluoropropyl)-cyclopentane-1,3-diol (**92**)³⁷ as detailed below.

Cyclopentane-1,3-diol with hexafluoropropene (γ -ray initiation).

Cyclopentane-1,3-diol (5.0 g, 49 mmol), acetone (20 ml) and HFP (22.5 g, 150 mmol) gave (**92**) (12.4 g, 63%) as colourless crystals after fractional distillation at reduced pressure followed by column chromatography over silica gel (4:1, DCM:Ethyl acetate). bp (4 mm Hg) 65-67 °C; (Found: C, 32.9; H, 2.4. $\text{C}_{11}\text{H}_{10}\text{F}_{12}\text{O}_2$ requires C, 32.6; H, 2.5%); NMR spectrum no. 16; Mass spectrum no. 24; IR spectrum no. 13.

Cyclopentane-1,3-diol with hexafluoropropene (peroxide initiation).

Cyclopentane-1,3-diol (10.0 g, 98 mmol), HFP (44.3 g, 295 mmol) and di-tert-butyl peroxide (1.3 g, 9 mmol) gave (**92**) (21.3 g, 54%) as described previously.

Pentane-2,4-diol with hexafluoropropene (γ -ray initiation).

Pentane-2,4-diol (7.2 g, 69 mmol), acetone (20 ml) and HFP (24.4 g, 162 mmol) gave 4,6-dimethyl-1,1,1,2,3,3,7,7,8,9,9,9-dodecafluorononane-4,6-diol (**94**)³⁷ (20.9 g, 75%) as colourless crystals after column chromatography over silica gel (5:1, DCM:Hexane). mp 87-88 °C; (Found: C, 32.9; H, 3.0. $\text{C}_{11}\text{H}_{12}\text{F}_{12}\text{O}_2$ requires C, 32.7; H, 3.0%); NMR spectrum no. 17; Mass spectrum no. 25; IR spectrum no. 14.

Hexane-2,5-diol with hexafluoropropene (γ -ray initiation).

Hexane-2,5-diol (7.9 g, 61 mmol), acetone (20 ml) and HFP (21.6 g, 144 mmol) gave 4,7-dimethyl-1,1,1,2,3,3,8,8,9,10,10,10-dodecafluorodecane-4,7-diol (**97**)³⁷ (8.9 g, 34%); bp (3 mm Hg) 63-66 °C; (Found: m/z $[\text{M}-\text{R}_\text{F}\text{H}]^+$, 267.0820. $\text{C}_{12}\text{H}_{14}\text{F}_{12}\text{O}_2$ requires m/z $[\text{M}-\text{R}_\text{F}\text{H}]^+$, 267.0820) (>95 pure by GC, trace decomposition products prohibit elemental analysis); NMR spectrum no. 18; Mass spectrum no. 26; IR spectrum no. 15; as a colourless oil and one compound that could not be separated from the starting material (ca. 9% by GC) but whose data was consistent with *4-methyl-1,1,1,2,3,3-hexafluorooctane-4,7-diol* (**96**); Mass spectrum no. 27.

Hexane-2,5-diol with excess hexafluoropropene (γ -ray initiation).

Hexane-2,5-diol (3.2 g, 27 mmol), acetone (20 ml) and HFP (20.6 g, 137 mmol) gave (**97**) (8.4 g, 73%) as described previously.

Propane-1,3-diol with hexafluoropropene (γ -ray initiation).

Propane-1,3-diol (4.6 g, 61 mmol), acetone (20 ml) and HFP (20.7 g, 138 mmol) gave *1,1,1,2,3,3,7,7,8,9,9,9-dodecafluorononane-4,6-diol* (**100**) (9.6 g, 42%); bp 186-188 °C; (Found: m/z [M]⁺, 376.0333. C₉H₈F₁₂O₂ requires m/z [M]⁺, 376.0333) (>95% pure by GC, trace decomposition products prohibit elemental analysis); NMR spectrum no. 19; Mass spectrum no. 28; IR spectrum no. 16; as a colourless oil after column chromatography over silica gel (1:2, DCM:Ethyl acetate) and one compound that could not be separated from the starting material (ca. 15% by GC) but whose data was consistent with *1,1,1,2,3,3-hexafluorohexane-4,6-diol* (**99**); Mass spectrum no. 29.

Propane-1,3-diol with hexafluoropropene (peroxide initiation).

Propane-1,3-diol (9.2 g, 122 mmol), HFP (54.9 g, 366 mmol) and di-*tert*-butyl peroxide (2.6 g, 18 mmol) gave (**100**) (28.0 g, 61%) as described previously.

Butane-1,4-diol with hexafluoropropene (γ -ray initiation).

Butane-1,4-diol (2.4 g, 27 mmol), acetone (20 ml) and HFP (12.2 g, 81 mmol) gave *1,1,1,2,3,3,8,8,9,10,10,10-dodecafluorononane-4,7-diol* (**9**)³⁶ (4.7 g, 45%); bp 192-195 °C; (Found: m/z [M+H]⁺, 391.0567. C₁₀H₁₀F₁₂O₂ requires m/z [M+H]⁺, 391.0567) (>90% pure by GC, decomposition products prohibit elemental analysis); NMR spectrum no. 20; Mass spectrum no. 30; as a colourless oil after column chromatography over silica gel (1:5, DCM:Ethyl acetate) and one compound that could not be separated from the starting material (ca. 9% by GC) but whose data was consistent with *1,1,1,2,3,3-hexafluoroheptane-4,7-diol* (**8**)³⁶; Mass spectrum no. 31.

Butane-1,4-diol with hexafluoropropene (peroxide initiation).

Butane-1,4-diol (2.4 g, 27 mmol), HFP (24.8 g, 165 mmol) and di-*tert*-butyl peroxide (1.6 g, 11 mmol) gave (**9**) (6.1 g, 58%) as described previously.

Butane-1,3-diol with hexafluoropropene (γ -ray initiation).

Butane-1,3-diol (5.0 g, 56 mmol), acetone (20 ml) and HFP (8.4 g, 56 mmol) gave a mixture of mono- (**102a**); Mass spectrum no. 32; (**102b**); Mass spectrum no. 33; and di-adducts (**103**); Mass spectrum no. 34; which could not be completely separated by column chromatography or fractional distillation.

Hexane-1,5-diol with hexafluoropropene (γ -ray initiation).

Hexane-1,5-diol (5.0 g, 42 mmol), acetone (20 ml) and HFP (6.3 g, 42 mmol) gave a mixture of mono- (**105a**); Mass spectrum no. 35; (**105b**); Mass spectrum no. 36; and di-adducts (**106**); Mass spectrum no. 37; which could not be completely separated by column chromatography or fractional distillation.

2-Hydroxytetrahydrofuran with hexafluoropropene (γ -ray initiation).

2-Hydroxytetrahydrofuran (5.0 g, 57 mmol), acetone (20 ml) and HFP (9.8 g, 65 mmol) gave a mixture of mono addition compounds (**109**) which could not be separated by column chromatography or fractional distillation. NMR spectrum (mixture) no. 23; Mass spectrum (major product) no. 38; Mass spectrum (lesser product) no. 39.

Tetrahydrofurfuryl alcohol with hexafluoropropene (γ -ray initiation).

Tetrahydrofurfuryl alcohol (5.0 g, 49 mmol), acetone (20 ml) and HFP (8.4 g, 56 mmol) gave *tetrahydrofurfuryl-1,1,2,3,3,3-hexafluoropropyl ether* (**112**) (5.8 g, 47%) as a colourless oil after fractional distillation at reduced pressure. bp (9 mm Hg) 75-78 °C; (Found: m/z (CI⁺) [M+NH₄]⁺, 270.0929. C₈H₁₀F₆O₂ requires m/z [M+NH₄]⁺, 270.0929) (>90% pure by GC, decomposition products prohibit elemental analysis); NMR spectrum no. 22; Mass spectrum no. 40.

Competition reaction for hexafluoropropene.

Cyclopentanol and 2-hydroxy-tetrahydrofuran (γ -ray initiation).

Cyclopentanol (4.9 g, 57 mmol), 2-hydroxy-tetrahydrofuran (5.0 g, 57 mmol), acetone (20 ml) and HFP (6.9 g, 46 mmol) were irradiated to the usual dosage. By GC, the composition of the mixture of reactants prior to reaction was 66.20% and 33.80% respectively, and after reaction was 20.91% and 8.56%. The relative conversions of the two species were calculated to be 68.41% and 74.67% respectively.

Cyclopentanol with perfluorocyclopentene (γ -ray initiation).

Cyclopentanol (2.2 g, 26 mmol), acetone (20 ml) and perfluorocyclopentene (6.4 g, 30 mmol) gave both isomers of *1-(2-hydro-perfluorocyclopentyl)-cyclopentan-1-ol* (**114**) (5.2g, 68%) in a 3:1 *trans:cis* ratio as colourless liquids after column chromatography over silica gel (9:1, DCM:Hexane). bp 162-163 °C; (Found: C, 40.3; H, 3.3. C₁₀H₁₀F₈O requires C, 40.3; H, 3.4%); *Trans* isomer: NMR spectrum no. 23; *Cis* Isomer: NMR spectrum no. 24; Mass spectrum (both isomers) no. 41; IR spectrum (both isomers) no. 17.

Cyclopentanol with perfluorocyclohexene (γ -ray initiation).

Cyclopentanol (3.4 g, 40 mmol), acetone (20 ml) and perfluorocyclohexene (11.7 g, 45 mmol) gave both isomers of *1-(2-hydro-perfluorocyclohexyl)-cyclopentan-1-ol* (**115**) (8.2g, 59%) in a 19:1 *trans:cis* ratio. After column chromatography over silica gel (DCM) only the *trans* isomer was isolated, as a colourless liquid. bp (3 mm Hg) 30-32 °C; (Found: C, 37.9; H, 2.9. C₁₁H₁₀F₁₀O requires C, 37.9; H, 2.9%); NMR spectrum no. 25; Mass spectrum no. 42; IR spectrum no. 18.

Cyclohexanol with perfluorocyclohexene (γ -ray initiation).

Cyclohexanol (5.0 g, 50 mmol), acetone (20 ml) and perfluorocyclohexene (13.5 g, 52 mmol) gave both isomers of *1-(2-hydro-perfluorocyclohexyl)-cyclohexan-1-ol* (**116**) (11.2g, 62%) in a 1:1 *trans:cis* ratio as colourless crystals after column chromatography over silica gel (6:1, DCM:Hexane). mp 70-71 °C; (Found: C, 39.7, H, 3.2. C₁₁H₁₀F₁₀O requires C, 39.8, H, 3.3%); *Trans* isomer: NMR spectrum no. 26; *Cis* Isomer: NMR spectrum no. 27; Mass spectrum (both isomers) no. 43; IR spectrum (both isomers) no. 19.

Chapter 9: Experimental to Chapter 5.

1-(1,1,2,3,3,3-Hexafluoropropyl)-cyclohexanol with potassium hydroxide.

Finely ground potassium hydroxide (5.8 g, 104 mmol) was dried under vacuum in a 250 ml sealable round bottomed flask, and dry hexane (20 ml) was added at room temperature. A solution of 1-(1,1,2,3,3,3-hexafluoropropyl)-cyclohexanol (8.6 g, 34 mmol) in hexane (5 ml) was added to the flask under an inert atmosphere. The resulting mixture was stirred at room temperature for 24 hours. After this time the solution was filtered and the filtrate was fractionally distilled at reduced pressure to give *1-(1,2,3,3,3-pentafluoro-E-prop-1-enyl)-cyclohexanol (119)* (6.3 g, 80%) as a colourless liquid. bp (40 mm Hg) 108-110 °C; NMR spectrum no. 28; Mass spectrum no. 44; IR spectrum no. 20.

1-(1,1,2,3,3,3-Hexafluoropropyl)-cyclopentanol with potassium hydroxide.

Finely ground potassium hydroxide (5.6 g, 100 mmol) was dried under vacuum in a 250 ml sealable round bottomed flask, and dry hexane (20 ml) was added at room temperature. A solution of 1-(1,1,2,3,3,3-hexafluoropropyl)-cyclopentanol (6.0 g, 25 mmol) in hexane (5 ml) was added to the flask as above and the resulting mixture was stirred at room temperature for 24 hours. After this time the solution was filtered and the filtrate was fractionally distilled at reduced pressure to give *1-(1,2,3,3,3-pentafluoro-E-prop-1-enyl)-cyclopentanol (124)* (4.7 g, 85%) as a colourless liquid. bp (42 mm Hg) 84-85 °C; (Found: C; 44.2; H; 4.2. C₈H₉F₅O requires C; 44.4; H; 4.2%); NMR spectrum no. 29; Mass spectrum no. 45; IR spectrum no. 21.

1-(1,1,2,3,3,3-Hexafluoropropyl)-cyclopentanol with acetyl chloride.

1-(1,1,2,3,3,3-Hexafluoropropyl)-cyclopentanol (4.5 g, 19 mmol) was added to an excess of acetyl chloride (20 ml) at room temperature, and the resulting solution was refluxed for 24 hours. Slow addition of the reaction mixture to water followed by extraction with DCM gave *1-(1,1,2,3,3,3-hexafluoropropyl)-cyclopentyl acetate (126)* (4.1 g, 78%) as a colourless liquid after column chromatography over silica gel (DCM). bp 166-168 °C; (Found: C, 43.1; H, 4.3. C₁₀H₁₂F₆O₂ requires C, 43.2; H, 4.3%); NMR spectrum no. 30; Mass spectrum no. 46; IR spectrum no. 22.

1,1,1,2,3,3,3,7,7,8,9,9,9-Dodecafluoro-4,6-dimethyl-nonan-4,6-diol with acetyl chloride.

1,1,1,2,3,3,3,7,7,8,9,9,9-Dodecafluoro-4,6-dimethyl-nonan-4,6-diol (1.5 g, 4 mmol) was added to an excess of acetyl chloride (20 ml) at room temperature, and the resulting solution was refluxed for 24 hours. Slow addition of the reaction mixture to water followed by extraction with DCM gave *1,1,1,2,3,3,3,7,7,8,9,9,9-dodecafluoro-4,6-dimethylnonane-4,6-diacetate (127)* (1.3 g, 72%) as a colourless liquid after column chromatography over silica gel (9:1, DCM:Ethyl acetate). bp 235-239 °C; (Found: C, 36.7; H, 3.3. C₁₅H₁₆F₁₂O₄ requires C, 36.9; H, 3.3%); NMR spectrum no. 31; Mass spectrum no. 47; IR spectrum no. 23.

1-(1,1,2,3,3,3-Hexafluoropropyl)-cyclopentanol with benzoyl chloride.

1-(1,1,2,3,3,3-Hexafluoropropyl)-cyclopentanol (3.0 g, 13 mmol) was added to an excess of benzoyl chloride (20 ml) at room temperature, and the resulting solution was then stirred at 70°C for 48 hours. Slow addition of the reaction mixture to water followed by extraction with DCM gave *1-(1,1,2,3,3,3-hexafluoropropyl)-cyclopentyl benzoate (129)* (3.1 g, 72%) as a colourless liquid after column chromatography over silica gel (DCM). bp 192-194 °C; (Found: m/z [M]⁺, 340.0898. C₁₅H₁₄O₂F₆ requires m/z [M]⁺ 340.0898) (>95% pure by GC, trace decomposition products prohibit elemental analysis); NMR spectrum no. 32; Mass spectrum no. 48; IR spectrum no. 24.

1-(1,1,2,3,3,3-Hexafluoropropyl)-cyclopentanol with methacryloyl chloride.

1-(1,1,2,3,3,3-Hexafluoropropyl)-cyclopentanol (2.4 g, 10 mmol) was added to an excess of methacryloyl chloride (20 ml) at room temperature, and the resulting solution was then stirred at 70°C for 96 hours. Slow addition of the reaction mixture to water followed by extraction with DCM gave *1-(1,1,2,3,3,3-hexafluoropropyl)-cyclopentyl methacrylate (131)* (1.6 g, 52%) as a colourless liquid after column chromatography over silica gel which polymerised upon standing to give solids that would not yield satisfactory elemental analyses. NMR spectrum no. 33; Mass spectrum no. 49.

Dehydrofluorination of 1-(1,1,2,3,3,3-hexafluoropropyl)-cyclopentyl acetate.

Finely ground potassium hydroxide (1.8 g, 32 mmol) was dried under vacuum in a 250 ml sealable round bottomed flask, and dry hexane (20 ml) was added at room temperature. A solution of 1-(1,1,2,3,3,3-hexafluoropropyl)-cyclopentyl acetate (1.8 g, 6 mmol) in hexane (5 ml) was added to the flask under an inert atmosphere. The resulting mixture was stirred at room temperature for 8 hours. After this time the solution was filtered and the filtrate was concentrated at reduced pressure. Column chromatography over silica gel gave *1-(1,2,3,3,3-pentafluoro-Z-prop-1-enyl)-cyclopentyl acetate (132)* (1.4 g, 84%). bp 157-160 °C; (Found: m/z (Cl⁺) [M+NH₄]⁺, 275.1023. C₁₀H₁₁F₅O₂ requires m/z [M+NH₄]⁺, 275.1023) (>95% pure by GC, volatility of compound prohibited elemental analysis); NMR spectrum no. 34; Mass spectrum no. 50.

1-(1,1,2,3,3,3-Hexafluoropropyl)-cyclopentanol with trimethylsilyl chloride.

1-(1,1,2,3,3,3-Hexafluoropropyl)-cyclopentanol (1.0 g, 4 mmol) was added to a mixture of a twofold excess of trimethylsilyl chloride (0.9 g, 8 mmol) and an excess of pyridine (10 ml) at 0°C, and the resulting solution was then stirred at room temperature for 2 hours. Slow addition of the reaction mixture to water followed by extraction with DCM gave *1-(1,1,2,3,3,3-hexafluoropropyl)-cyclopentoxyl-trimethyl silane (140)* (1.0 g, 84%) as a colourless liquid after column chromatography over silica gel (8:1,

DCM:Hexane). bp 154-155 °C; (Found: m/z [M-H]⁺, 307.0954. C₁₁H₁₈OSiF₆ requires m/z [M-H]⁺, 307.0953) (>95% pure by GC, traces of decomposition products prohibited elemental analysis); NMR spectrum no. 35; Mass spectrum no. 51; IR spectrum no. 25.

General Procedure for Dehydration Reactions.

A 250 ml one-necked round bottomed flask was charged with the alcohol, thionyl chloride (approximately 10 fold molar excess) was added at room temperature, and the resulting solution was refluxed, with the emitted gases being passed through a potassium hydroxide solution scrubber. The mixture was allowed to cool to room temperature, and the resulting product solution was carefully added dropwise to a cooled (ice bath) mixture of ice and DCM. The resulting mixture was extracted three times with DCM, and the combined organic extracts were washed twice with water, dried (MgSO₄) and concentrated at reduced pressure. Purification by column chromatography over silica gel or fractional distillation yielded the desired alkenes.

1-(1,1,2,3,3,3-Hexafluoropropyl)-cyclohexanol.

1-(1,1,2,3,3,3-Hexafluoropropyl)-cyclohexanol (29.9 g, 120 mmol) and thionyl chloride (104 ml, 1.33 mol) were refluxed for 24 hours to give 1-(1,1,2,3,3,3-hexafluoropropyl)-cyclohexene (**142**)³⁷ (24.4g, 88%) as a colourless liquid after column chromatography over silica gel (DCM). bp 153-154 °C; (Found: C, 46.3; H, 4.3. C₉H₁₀F₆ requires C, 46.6; H, 4.3%); NMR spectrum no. 36; Mass spectrum no. 52; IR spectrum no. 26.

1-(1,1,2,3,3,3-hexafluoropropyl)-cyclopentanol.

1-(1,1,2,3,3,3-Hexafluoropropyl)-cyclopentanol (18.5 g, 74 mmol) and thionyl chloride (72 ml, 888 mmol) were refluxed for 24 hours to give 1-(1,1,2,3,3,3-hexafluoropropyl)-cyclopentene (**143**)³⁷ (10.5g, 65%) as a colourless liquid after column chromatography over silica gel (DCM). bp 128-130 °C; (Found: C, 44.0; H, 3.6. C₈H₈F₆ requires C, 44.0; H, 3.7%); NMR spectrum no. 37; Mass spectrum no. 53; IR spectrum no. 27.

1-(1,1,2,3,3,3-hexafluoropropyl)-cycloheptanol.

1-(1,1,2,3,3,3-Hexafluoropropyl)-cycloheptanol (10.4 g, 39 mmol) and thionyl chloride (38 ml, 473 mmol) were refluxed for 24 hours to give 1-(1,1,2,3,3,3-hexafluoropropyl)-cycloheptene (**144**) (5.8g, 60%) as a colourless liquid after column chromatography over silica gel (DCM). bp 171-174 °C; NMR spectrum no. 38; Mass spectrum no. 54; IR spectrum no. 28.

2-(1,1,2,3,3,3-Hexafluoropropyl)-norborneol.

1-(1,1,2,3,3,3-Hexafluoropropyl)-norborneol (2.5 g, 9.5 mmol) and thionyl chloride (8 ml, 99 mmol) were refluxed for 24 hours to give *1-(1,1,2,3,3,3-hexafluoropropyl)-norbornene (145)* (1.3g, 56%) as a colourless liquid after column chromatography over silica gel (9:1, DCM:Ethyl acetate). bp 163-165 °C; (Found: m/z [M]⁺, 244.0687. C₁₀H₁₀F₆ requires m/z [M]⁺, 244.0687) (>90% pure by GC, decomposition products prohibit elemental analysis); NMR spectrum no. 39; Mass spectrum no. 55; IR spectrum no. 29.

1-(2-Hydro-perfluorocyclopentyl)-cyclopentan-1-ol.

A 3:1 *trans:cis* mixture of both isomers of 1-(2-hydro-perfluorocyclopentyl)-cyclopentan-1-ol (1.4 g, 5 mmol) and thionyl chloride (10 ml, 123 mmol) were refluxed for 24 hours to give a 3:1 *trans:cis* mixture of both isomers of *1-(2-hydro-perfluorocyclopentyl)-cyclopentene (146)* (0.9g, 71%) as a colourless liquid after column chromatography over silica gel (3:1, DCM:Ethyl acetate). bp 135-137 °C; (Found: m/z [M-H]⁺, 279.0419. C₁₀H₈F₈ requires m/z [M-H]⁺, 279.0420) (>95% pure by GC, trace decomposition products prohibit elemental analysis). No further separation was performed, but the NMR data for the mixture could be assigned to each isomer on the basis of 3:1 relative peak intensities. *Trans* isomer: NMR spectrum no. 40; *Cis* isomer: NMR spectrum no. 41; Mass spectrum (both isomers) no. 56; IR spectrum (both isomers) no. 30.

1-(2-Hydro-perfluorocyclohexyl)-cyclohexan-1-ol.

A 1:1 *trans:cis* mixture of both isomers of 1-(2-hydro-perfluorocyclohexyl)-cyclohexan-1-ol (1.8 g, 5 mmol) and thionyl chloride (10 ml, 123 mmol) were refluxed for 24 hours to give a 1:1 *trans:cis* mixture of both isomers of *1-(2-hydro-perfluorocyclohexyl)-cyclohexene (147)* (1.0g, 58%) as a colourless liquid after column chromatography over silica gel (5:1, DCM:Ethyl acetate). bp 158-161 °C; (Found: C, 41.6; H, 2.9. C₁₂H₁₀F₁₀ requires C, 41.9; H, 2.9%). No further separation could be achieved. NMR spectrum (both isomers) no. 42; Mass spectrum (both isomers) no. 57.

1,3-Di-(1,1,2,3,3,3-hexafluoropropyl)-cyclopentan-1,3-diol.

1,3-Di-(1,1,2,3,3,3-hexafluoropropyl)-cyclopentan-1,3-diol (6.4 g, 16 mmol) and thionyl chloride (20 ml, 247 mmol) were refluxed for 96 hours to give a mixture of *1,x-di-(1,1,2,3,3,3-hexafluoropropyl)-cyclopentadienes (x=3,4) (148)* (1.9g, 32%) as a colourless liquid after column chromatography over silica gel (1:2, DCM, Ethyl acetate). bp 196-199 °C; (Found: m/z [M]⁺, 366.0278. C₁₁H₆F₁₂ requires m/z [M]⁺, 366.0278) (>90% pure by GC, decomposition products prohibit elemental analysis); NMR spectrum no. 43; Mass spectrum no. 58.

1-(1,1,2,3,3,3-Hexafluoropropyl)-cyclohexene with bromine.

1-(1,1,2,3,3,3-Hexafluoropropyl)-cyclohexene (2.0 g, 9 mmol) was placed in a two-necked flask fitted with a condenser and a pressure equalising dropping funnel and cooled in an ice bath. Elemental bromine (3.2 g, 20 mmol) was added *via* the funnel and the mixture was stirred at room temperature for 12 hours. The mixture was then diluted with DCM (50 ml) and washed with 10 % aqueous sodium metabisulphate. The organic layer was separated and the aqueous layer was further extracted with DCM (2 x 50ml). The combined organic layers were washed with water, dried (MgSO₄) and concentrated under vacuum to yield 1-(1,1,2,3,3,3-hexafluoropropyl)-1,2-dibromocyclohexane (**149**)³⁷ (3.0 g, 88%) as a colourless liquid after column chromatography over silica gel (DCM). bp (3 mm Hg) 58-60 °C; (Found: C, 27.3; H, 2.5. C₉H₁₀Br₂F₆ requires C, 27.6; H, 2.6%); NMR spectrum no. 44; Mass spectrum no. 59; IR spectrum no. 31.

1-(1,1,2,3,3,3-Hexafluoropropyl)-cyclopentene with bromine.

1-(1,1,2,3,3,3-Hexafluoropropyl)-cyclopentene (2.0 g, 9 mmol) was reacted with bromine (3.0 g, 19 mmol) as above to yield 1-(1,1,2,3,3,3-hexafluoropropyl)-1,2-dibromocyclopentane (**150**)³⁷ (2.0g, 58%); bp (5 mm Hg) 63-65 °C; (Found: C, 25.5; H, 2.2. C₈H₈Br₂F₆ requires C, 25.4; H, 2.1%); NMR spectrum no. 45; Mass spectrum no. 60; IR spectrum no. 32; and 1-(1,1,2,3,3,3-hexafluoropropyl)-5-bromocyclopentene (**151**) (0.9g, 33%); (Found: *m/z* [M-Br]⁺, 217.0452. C₈H₇BrF₆ requires *m/z* [M-Br]⁺, 217.0452) (>90% pure by GC, decomposition products prohibit elemental analysis); NMR spectrum no. 46; Mass spectrum no. 61; IR spectrum no. 33; as colourless liquids after column chromatography over silica gel (DCM).

1-(1,1,2,3,3,3-Hexafluoropropyl)-cyclopentene with meta-chloro-perbenzoic acid.

1-(1,1,2,3,3,3-Hexafluoropropyl)-cyclopentene (3.0 g, 14 mmol) was placed in a flask fitted with a condenser and cooled in an ice bath. *Meta*-chloro-perbenzoic acid (4.8 g, 28 mmol) was added over a period of 30 minutes and the mixture was refluxed for 7 days. The solution was allowed to cool to room temperature and excess dry KF was then added. The resulting mixture was stirred at room temperature for one hour and the solids were removed by filtration. The filter residue was washed with dichloromethane and the combined organic extracts were dried (MgSO₄). The solvent was distilled off at reduced pressure to give 1-(1,1,2,3,3,3-hexafluoropropyl)-cyclopentene epoxide (**152**)³⁷ (2.0 g, 61%) as a colourless liquid. bp 142-144 °C; (Found: *m/z* [M-H]⁺, 233.0401. C₈H₇F₆O requires *m/z* [M-H]⁺, 233.0401) (>95% pure by GC, traces of decomposition products prohibit elemental analysis); NMR spectrum no. 47; Mass spectrum no. 62; IR spectrum no. 34.

1-(1,1,2,3,3,3-hexafluoropropyl)-cyclohexene with meta-chloro-perbenzoic acid.

1-(1,1,2,3,3,3-Hexafluoropropyl)-cyclohexene (3.0 g, 13 mmol), was reacted with *meta*-chloro-perbenzoic acid (4.6 g, 27 mmol) as above to give 1-(1,1,2,3,3,3-hexafluoropropyl)-cyclohexene epoxide (**153**)³⁷ (2.2 g, 66%) as a colourless liquid. bp 161-162 °C; (Found: m/z [M]⁺, 248.0636. C₉H₁₀F₆O requires m/z [M]⁺, 248.0626) (>95% pure by GC, traces of decomposition products prohibit elemental analysis); NMR spectrum no. 48; Mass spectrum no. 63; IR spectrum no. 35.

1-(1,1,2,3,3,3-hexafluoropropyl)-cyclohexene epoxide with dilute sulphuric acid.

1-(1,1,2,3,3,3-Hexafluoropropyl)-cyclohexene epoxide (0.8 g, 3 mmol) was added to 10 ml of 5% sulphuric acid solution and the resulting mixture was refluxed at 100°C for 24 hours. The mixture was then allowed to reach room temperature and extracted exhaustively with DCM. The organic extracts were dried (MgSO₄) and the solvent was removed at reduced pressure to give 1-(1,1,2,3,3,3-hexafluoropropyl)-cyclohexane-1,2-diol (**154**)³⁷ (0.7 g, 82%) as a white solid. mp 78-79 °C; (Found: m/z [M-H₂O-HF]⁺, 228.0569. C₉H₁₂F₆O₂ requires m/z [M-H₂O-HF]⁺, 228.0574) (>90% pure by GC, decomposition products prohibit elemental analysis); NMR spectrum no. 49; Mass spectrum no. 64; IR spectrum no. 36.

Reaction of 1-(1,1,2,3,3,3-hexafluoropropyl)-cyclohexene with two equivalents of N-bromosuccinimide.

1-(1,1,2,3,3,3-Hexafluoropropyl)-cyclohexene (2.0 g, 9 mmol) and N-bromosuccinimide (3.1 g, 17 mmol) were added to carbon tetrachloride (10 ml) and the solution was raised to reflux. One or two crystals of di-benzoyl peroxide were added via the condenser at this temperature and the solution was refluxed overnight. The solution was then added to water (50 ml) and extracted three times with DCM. The organic extracts were combined, washed with water (50 ml), dried (MgSO₄) and the chlorinated solvents were distilled off and retained. The resulting pale yellow oil was distilled at reduced pressure to give 3,6-dibromo-(1,1,2,3,3,3-hexafluoropropyl)-cyclohexene (**155**) (2.3 g, 67%) as a colourless liquid. bp (5 mm Hg) 52-54 °C; (Found: m/z [M-Br]⁺, 308.9713. C₉H₈Br₂F₆ requires m/z [M-Br]⁺, 308.9708) (>95% pure by GC, traces of decomposition products prohibit elemental analysis); NMR spectrum no. 50; Mass spectrum no. 65; IR spectrum no. 37.

Dehydrobromination of 3,6-dibromo-(1,1,2,3,3,3-hexafluoropropyl)-cyclohexene with lithium chloride in N,N-dimethyl formamide.

3,6-Dibromo-(1,1,2,3,3,3-hexafluoropropyl)-cyclohexene (4.3 g, 11 mmol) was dissolved in DMF (30 ml) and lithium chloride (2.0 g, 47 mmol) was added at room temperature. The mixture was stirred at 150 °C for 24 hours and then allowed to return to room temperature and exhaustively extracted with hexane. Fractional distillation

gave (1,1,2,3,3,3-hexafluoropropyl)-benzene (**156**)³⁷ (1.4 g, 55%) as a colourless liquid. bp 140-142 °C; (Found: m/z [M]⁺, 228.0377. C₉H₆F₆ requires m/z [M]⁺, 228.0374) (>95% pure by GC, traces of decomposition products prohibit elemental analysis); NMR spectrum no. 51; Mass spectrum no. 66.

1-(1,1,2,3,3,3-hexafluoropropyl)-cyclohexene with three equivalents of N-bromosuccinimide.

1-(1,1,2,3,3,3-Hexafluoropropyl)-cyclohexene (1.0 g, 4 mmol) reacted with N-bromosuccinimide (2.1 g, 12 mmol) in carbon tetrachloride (10 ml) as above to give 2-bromo-(1,1,2,3,3,3-hexafluoropropyl)-benzene (**157**) (0.3 g, 26%) as a colourless liquid. bp 181-183 °C; (Found: m/z [M]⁺, 305.9479. C₉H₅BrF₆ requires m/z [M]⁺, 305.9479) (>90% pure by GC, decomposition products prohibit elemental analysis); NMR spectrum no. 52; Mass spectrum no. 67.

Dehydrofluorination of 1-(1,1,2,3,3,3-hexafluoropropyl)-cyclopentene.

Coarsely ground potassium hydroxide (5.0 g, 89 mmol) was dried under vacuum in a 250 ml sealable round bottomed flask, and 1-(1,1,2,3,3,3-hexafluoropropyl)-cyclopentene (4.0 g, 18 mmol) was transferred to the flask at reduced pressure. The resulting mixture was stirred for 8 hours at ambient temperature and after this time the volatiles were removed from the flask at reduced pressure, giving 1-(1,2,3,3,3-pentafluoro-Z-prop-1-enyl)-cyclopentene (**159**) (3.3 g, 90%) as a colourless liquid. bp 111-112 °C; (Found: m/z [M]⁺, 194.0465. C₈H₇F₅ requires m/z [M]⁺, 194.0468) (>95% pure by GC, volatility of compound prohibit elemental analysis); NMR spectrum no. 53; Mass spectrum no. 68; IR spectrum no. 38.

Dehydrofluorination of 1-(1,1,2,3,3,3-hexafluoropropyl)-cyclohexene.

1-(1,1,2,3,3,3-hexafluoropropyl)-cyclohexene (5.0 g, 22 mmol) was reacted with coarsely ground potassium hydroxide (6.5 g, 116 mmol) as above to give 1-(1,2,3,3,3-pentafluoro-Z-prop-1-enyl)-cyclohexene (**160**) (3.9 g, 85%) as a colourless liquid. bp 122-124 °C; (Found: m/z [M]⁺, 212.0623. C₈H₇F₅ requires m/z [M]⁺, 212.0624) (>95% pure by GC, volatility of compound prohibit elemental analysis); NMR spectrum no. 54; Mass spectrum no. 69; IR spectrum no. 39.

Dehydrofluorination of 1-(2-hydro-perfluorocyclopentyl)-cyclopentene.

Finely ground potassium hydroxide (2.0 g, 36 mmol) was dried under vacuum in a 250 ml sealable round bottomed flask, and dry hexane (20 ml) was added at room temperature. A solution of 1-(2-hydro-perfluorocyclopentyl)-cyclopentene (1.0 g, 4 mmol) in hexane (5 ml) was added to the flask under an inert atmosphere. The resulting mixture was stirred at room temperature for 8 hours. After this time the solution was filtered and the filtrate was concentrated at reduced pressure. Column

chromatography over silica gel (DCM) gave *1-(perfluorocyclopent-1-enyl)-cyclopentene* (**161**) (0.7 g, 80%) as a colourless liquid; (Found: m/z $[M]^+$, 260.0436. $C_{10}H_7F_7$ requires m/z $[M]^+$, 260.0436) (>90% pure by GC, decomposition products prohibit elemental analysis); NMR spectrum no. 55; Mass spectrum no. 70; and one compound that could not be separated but whose data is consistent with *1-(perfluorocyclopent-2-enyl)-cyclopentene*; NMR spectrum no. 56; Mass spectrum no. 71.

1-(1,2,3,3,3-pentafluoro-Z-prop-1-enyl)-cyclopentene with methoxide.

Finely ground potassium hydroxide (1.1 g, 20 mmol) was added to methanol (10 ml) and the resultant mixture was stirred until the solution had returned to ambient temperature. *1-(1,2,3,3,3-pentafluoro-Z-prop-1-enyl)-cyclopentene* (2.0 g, 10 mmol) was added to the solution and the resulting dark mixture was stirred at room temperature for 12 hours. After this time the liquid was added to water (50 ml) and continuously extracted with hexane. The organic extracts were dried ($MgSO_4$) and concentrated and the resulting liquid was purified by column chromatography over silica gel (DCM) to give *1-(2,3,3,3-tetrafluoro-1-methoxy-prop-1-enyl)-cyclopentene* (**163**) (1.7 g, 80%); (>90% pure by GC, decomposition products prohibit elemental analysis); NMR spectrum no. 57; Mass spectrum no. 72.

1-(1,2,3,3,3-pentafluoro-Z-prop-1-enyl)-cyclopentene with propoxide.

Finely ground potassium hydroxide (1.1 g, 20 mmol) was added to propanol (10 ml) and the resultant mixture was stirred until the solution had returned to ambient temperature. *1-(1,2,3,3,3-pentafluoro-Z-prop-1-enyl)-cyclopentene* (2.0 g, 10 mmol) was added to the solution and the resulting dark mixture was stirred at room temperature for 12 hours as above to give *1-(2,3,3,3-tetrafluoro-1-propoxy-prop-1-enyl)-cyclopentene* (**164**) (2.2 g, 91%); (>90% pure by GC, decomposition products prohibit elemental analysis); NMR spectrum no. 58; Mass spectrum no. 73.

1-(1,2,3,3,3-pentafluoro-Z-prop-1-enyl)-cyclopentene with phenyl-methoxide.

Finely ground potassium hydroxide (1.1 g, 20 mmol) was added to benzyl alcohol (10 ml) and the resultant mixture was stirred until the solution had returned to ambient temperature. *1-(1,2,3,3,3-pentafluoro-Z-prop-1-enyl)-cyclopentene* (2.0 g, 10 mmol) was added to the solution and the resulting dark mixture was stirred at room temperature for 12 hours as above to give *1-(2,3,3,3-tetrafluoro-1-phenylmethoxy-prop-1-enyl)-cyclopentene* (**165**) (2.2 g, 76%); (>90% pure by GC, decomposition products prohibit elemental analysis); NMR spectrum no. 59; Mass spectrum no. 74.

1-(1,2,3,3,3-pentafluoro-Z-prop-1-enyl)-cyclohexene with meta-chloro-perbenzoic acid.

1-(1,2,3,3,3-Pentafluoro-Z-prop-1-enyl)-cyclohexene (5.0 g, 22 mmol) was placed in a flask fitted with a condenser and cooled in an ice bath. *Meta*-chloro-perbenzoic acid (7.2 g, 42 mmol) was added over a period of 30 minutes and the mixture was refluxed for 7 days. The solution was allowed to cool to room temperature and excess dry KF was then added. The resulting mixture was stirred at room temperature for one hour and the solids were removed by filtration. The filter residue was washed with dichloromethane and the combined organic extracts were dried (MgSO₄). The solvent was removed off at reduced pressure and column chromatography over silica gel (DCM) gave *1-(1,2,3,3,3-pentafluoro-E-prop-1-enyl)-cyclohexene epoxide (166)* (2.0 g, 61%); (Found: m/z [M]⁺, 228.0574. C₉H₉F₅O requires m/z [M]⁺, 2328.0572) (>95% pure by GC, volatility of compound prohibits elemental analysis); NMR spectrum no. 60; Mass spectrum no. 75; IR spectrum no. 40; as a colourless liquid and one compound that could not be isolated but whose data was consistent with *1-(1,2,3,3,3-pentafluoro-E-prop-1-enyl epoxide)-cyclohexene epoxide (167)*; NMR spectrum no 62; Mass spectrum no. 75.

Appendix A: NMR Spectra.

Appendix A.i.: NMR Spectra for Chapter 2.

NMR Spectrum 1: 1-(1,1,2,3,3,3-Hexafluoropropyl)-cyclohexanol (**46**).

NMR Spectrum 2: 1-(1,1,2,3,3,3-Hexafluoropropyl)-cyclobutanol (**52**).

NMR Spectrum 3: 1-(1,1,2,3,3,3-Hexafluoropropyl)-cyclopentanol (**54**).

NMR Spectrum 4: 1-(1,1,2,3,3,3-Hexafluoropropyl)-cycloheptanol (**56**).

NMR Spectrum 5: 1-(1,1,2,3,3,3-Hexafluoropropyl)-cyclooctanol (**61**).

NMR Spectrum 1: 1-(1,1,2,3,3,3-Hexafluoropropyl)-cyclohexanol (**46**).

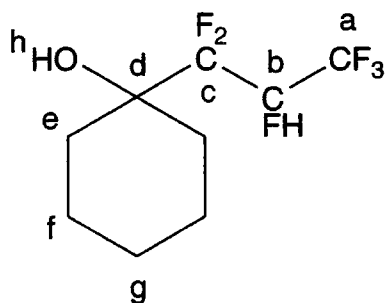

Chemical Shift (ppm)	Multiplicity	Coupling Constants	Relative Intensity	Assignment
¹H				
1.16-1.90	m		10	e,f,g
3.09	s		1	h
5.68	d d q d	$^2J_{HF} = 42.8$ $^3J_{HF1} = 17.2$ $^3J_{HF} = 6.8$ $^3J_{HF2} = 1.6$	1	b
¹³C				
21.07	s			f
21.22	s			f
25.88	s			g
29.06	t	$^3J_{CF} = 4.6$		e
30.41	t	$^3J_{CF} = 4.9$		e
73.74	t	$^2J_{CF} = 23.6$		d
73.84	t	$^2J_{CF} = 24.3$		d
83.56	d d q d	$^1J_{CF} = 193$ $^2J_{CF1} = 37.0$ $^2J_{CF} = 33.6$ $^2J_{CF2} = 23.6$		b
119.49	d d d	$^1J_{CF1} = 264$ $^1J_{CF2} = 251$		c
122.55	q d	$^2J_{CF} = 21.0$ $^1J_{CF} = 282$ $^2J_{CF} = 26.4$		a
¹⁹F				
-74.77	m		3	a
-126.91 and -128.51	AB	$J_{AB} = 272$	2	c
-208.27	d m	$^2J_{FH} = 42.8$	1	b

NMR Spectrum 2: 1-(1,1,2,3,3,3-Hexafluoropropyl)-cyclobutanol (**52**).

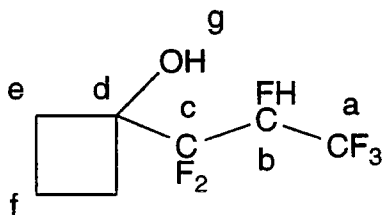

Chemical Shift (ppm)	Multiplicity	Coupling Constants	Relative Intensity	Assignment
¹H				
1.82	m		1	f
2.04	m		3	e,f
2.60	m		2	e
3.14	br s		1	g
5.17	d d q d	$^2J_{HF} = 43.2$ $^3J_{HF1} = 18.4$ $^3J_{HF} = 6.0$ $^3J_{HF2} = 3.2$	1	b
¹³C				
13.10	s			f
29.85	s			e
30.21	s			e
76.13	d d	$^2J_{CF} = 31.3$ $^2J_{CF} = 26.4$		d
83.99	d d q d	$^1J_{CF} = 194$ $^2J_{CF1} = 37.7$ $^2J_{CF} = 34.3$ $^2J_{CF2} = 25.5$		b
117.43	d d d	$^1J_{CF1} = 257$ $^1J_{CF2} = 248$ $^2J_{CF} = 24.0$		c
121.06	q d	$^1J_{CF} = 282$ $^2J_{CF} = 25.5$		a
¹⁹F				
-74.60	m		3	a
-126.47 and -128.41	AB	$J_{AB} = 275$	2	c
-213.30	d m	$^2J_{HF} = 43.2$	1	b

NMR Spectrum 3: 1-(1,1,2,3,3,3-Hexafluoropropyl)-cyclopentanol (**54**).

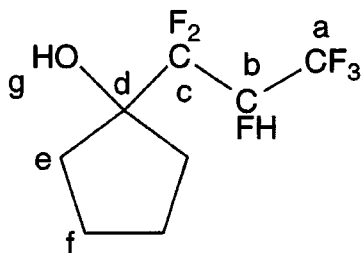

Chemical Shift (ppm)	Multiplicity	Coupling Constants	Relative Intensity	Assignment
¹H				
1.65-2.20	m		8	e,f
5.11	br s		1	g
5.26	d d q	$^2J_{HF} = 43.2$ $^3J_{HF1} = 19.2$ $^3J_{HF} = 6.4$	1	b
¹³C				
23.09	s			f
24.24	d	$^4J_{CF} = 1.9$		f
34.10	d d	$^3J_{CF1} = 5.3$ $^3J_{CF2} = 4.2$		e
35.21	d d	$^3J_{CF1} = 2.3$ $^3J_{CF2} = 1.6$		e
83.33	m			b
83.61	d d	$^2J_{CF} = 27.1$ $^2J_{CF} = 23.6$		d
118.38	d d d	$^1J_{CF1} = 262$ $^1J_{CF2} = 247$ $^2J_{CF} = 23.6$		c
121.16	q d	$^1J_{CF} = 283$ $^2J_{CF} = 26.0$		a
¹⁹F				
-74.22	m		3	a
-120.97 and -126.77	AB	$J_{AB} = 275$	2	c
-209.65	d m	$^2J_{FH} = 43.2$	1	b

NMR Spectrum 4: 1-(1,1,2,3,3,3-Hexafluoropropyl)-cycloheptanol (**56**).

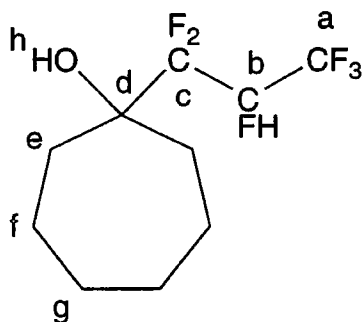

Chemical Shift (ppm)	Multiplicity	Coupling Constants	Relative Intensity	Assignment
¹H				
1.48-2.16	m		13	e,f,g,h
5.20	d d q d	$^2J_{HF} = 44.0$ $^3J_{HF1} = 17.6$ $^3J_{HF} = 6.8$ $^3J_{HF2} = 1.2$	1	b
¹³C				
21.59	s			f
21.87	d	$^4J_{CF} = 1.5$		f
29.55	s			g
29.74	s			g
33.91	d d	$^3J_{CF1} = 2.6$ $^3J_{CF2} = 2.3$		e
34.10	d	$^3J_{CF1} = 4.6$		e
77.53	t	$^2J_{CF} = 24.0$		d
83.05	d d q d	$^1J_{CF} = 196$ $^2J_{CF1} = 37.7$ $^2J_{CF} = 33.5$ $^2J_{CF2} = 23.6$		b
118.71	d d d	$^1J_{CF1} = 266$ $^1J_{CF2} = 251$ $^2J_{CF} = 20.5$		c
121.17	q d	$^1J_{CF} = 283$ $^2J_{CF} = 26.4$		a
¹⁹F				
-74.22	m		3	a
-122.45 and -127.25	AB	$J_{AB} = 278$	2	c
-206.71	d q	$^2J_{FH} = 44.0$ $^3J_{FF} = 9.4$	1	b

NMR Spectrum 5: 1-(1,1,2,3,3,3-Hexafluoropropyl)-cyclooctanol (**61**).

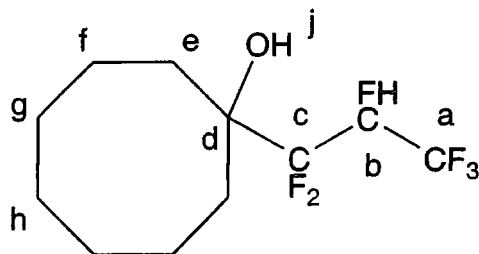

Chemical Shift (ppm)	Multiplicity	Coupling Constants	Relative Intensity	Assignment
¹H				
1.40-1.97	m		14	e,f,g,h
3.86	br s		1	j
5.24	d d q	$^2J_{\text{HF}} = 43.6$ $^3J_{\text{HF1}} = 18.0$ $^3J_{\text{HF}} = 6.4$	1	b
¹³C				
21.30	s			g
21.39	s			g
24.99	s			h
27.09	s			f
27.34	s			f
29.68	t	$^3J_{\text{CF}} = 3.0$		e
30.02	d	$^3J_{\text{CF1}} = 4.9$		e
77.54	m			d
82.78	d d q d	$^1J_{\text{CF}} = 196$ $^2J_{\text{CF1}} = 37.0$ $^2J_{\text{CF}} = 34.0$ $^2J_{\text{CF2}} = 23.6$		b
118.89	d d d	$^1J_{\text{CF1}} = 267$ $^1J_{\text{CF2}} = 252$ $^2J_{\text{CF}} = 21.4$		c
121.16	q d	$^1J_{\text{CF}} = 283$ $^2J_{\text{CF}} = 26.4$		a
¹⁹F				
-73.97	m		3	a
-121.77 and -124.49	AB	$J_{\text{AB}} = 278$	2	c
-206.78	d m	$^2J_{\text{FH}} = 43.6$	1	b

Appendix A.ii.: NMR Spectra for Chapter 3.

NMR spectrum 6: 4-Methyl-1-(1,1,1,2,3,3-hexafluoropropyl)-cyclohexanol (68).

NMR spectrum 7: 1,4-Di-(1,1,2,3,3,3-hexafluoropropyl)-4-methyl-cyclohexanol (69).

NMR spectrum 8: 4-*Tert*-butyl-1-(1,1,1,2,3,3-hexafluoropropyl)-cyclohexanol (71).

NMR spectrum 9: 1-(1,1,2,3,3,3-hexafluoropropyl)-2-(2,2,3,4,4,4-hexafluorobutyl)-cyclohexanol (73).

NMR spectrum 10: *Exo*-2-(1,1,2,3,3,3-hexafluoropropyl)-norbornan-2-ol (77).

NMR spectrum 11: 1,*x*-Di-(1,1,2,3,3,3-hexafluoropropyl)-decahydronapthan-1-ol (79).

NMR spectrum 12: 2-(1,1,2,3,3,3-Hexafluoropropyl)-decahydronapthan-2-ol (81).

NMR Spectrum 6: 4-Methyl-1-(1,1,1,2,3,3-hexafluoropropyl)-cyclohexan-1-ol (68).

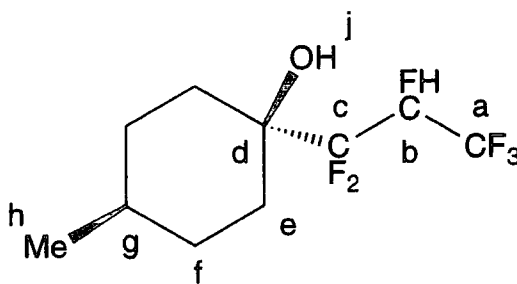

Chemical Shift (ppm)	Multiplicity	Coupling Constants	Relative Intensity	Assignment
¹H				
0.94	d	$^3J_{HH} = 6.4$	3	h
1.31	m		2	f,g
1.60	m		3	f
1.76	m		4	e
5.25	d d q d	$^2J_{HF} = 43.7$ $^3J_{HF1} = 17.6$ $^3J_{HF} = 6.4$ $^3J_{HF2} = 1.2$	1	b
¹³C				
22.02	s			h
28.79	s			f
28.89	s			f
29.12	m			e
29.30	m			e
31.62	s			g
73.73	t	$^2J_{CF} = 24.3$		d
82.96	d d q d	$^1J_{CF} = 196$ $^2J_{CF1} = 34.4$ $^2J_{CF} = 33.9$ $^2J_{CF2} = 24.3$		b
118.25	d d d	$^1J_{CF1} = 265$ $^1J_{CF2} = 250$ $^2J_{CF} = 18.3$		c
121.37	q d	$^1J_{CF} = 283$ $^2J_{CF} = 25.9$		a
¹⁹F				
-74.56	m		3	a
-126.71 and -128.95	AB	$J_{AB} = 275$	2	c
-207.81	d q	$^2J_{FH} = 43.7$ $^3J_{FF} = 10.5$	1	b

NMR Spectrum 7: 1,4-Di-(1,1,1,2,3,3-hexafluoropropyl)-4-methylcyclohexanol (**69**).

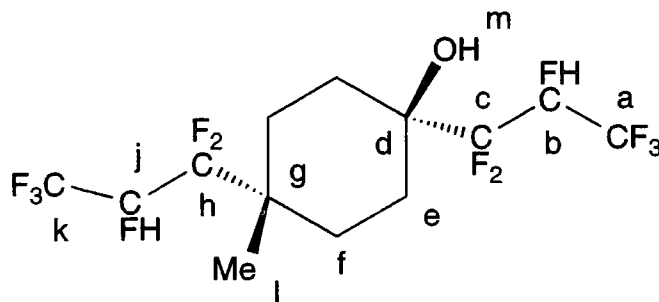

Chemical Shift (ppm)	Multiplicity	Coupling Constants	Relative Intensity	Assignment
¹H				
1.18	s		3	l
1.64-2.17	m		8	e,f
4.97	d d q	$^2J_{HF} = 44.0$ $^3J_{HF1} = 20.0$ $^3J_{HF} = 6.6$	1	j
5.25	d d q	$^2J_{HF} = 43.6$ $^3J_{HF1} = 18.0$ $^3J_{HF} = 6.4$	1	b
¹³C				
15.62	s			h
23.66	m			f
24.48	m			e
30.03	m			g
73.12	m			d
83.86	m			b,j
119.68	m			c,h
122.76	m			a,k
¹⁹F				
-74.24	m		3	a or k
-74.36	m		3	a or k
-119.84 and -127.18	AB	$J_{AB} = 271$	2	h
-127.00 and -128.72	AB	$J_{AB} = 278$	2	c
-206.79	m		1	j
-207.81	m		1	b

NMR Spectrum 8: 1-(1,1,2,3,3,3-Hexafluoropropyl)-4-*tert*-butyl-cyclohexanol (71).

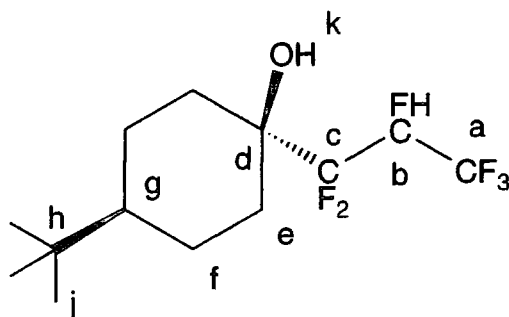

Chemical Shift (ppm)	Multiplicity	Coupling Constants	Relative Intensity	Assignment
¹H				
0.88	s		9	j
1.02	m		1	e or f
1.34	m		2	e or f
1.63	m		1	g
1.74	m		5	e,f
5.24	d d q d	$^2J_{HF} = 43.5$ $^3J_{HF1} = 17.6$ $^3J_{HF} = 6.4$ $^3J_{HF2} = 1.8$	1	b
¹³C				
21.48	s			f
21.58	s			f
27.58	s			j
29.84	m			e
29.99	m			e
32.55	s			h
42.27	s			g
73.92	t	$^2J_{CF} = 24.3$		d
82.97	d d q d	$^1J_{CF} = 196$ $^2J_{CF1} = 37.3$ $^2J_{CF} = 33.9$ $^2J_{CF2} = 24.3$		b
118.23	d d d	$^1J_{CF1} = 272$ $^1J_{CF2} = 250$ $^2J_{CF} = 21.4$		c
121.56	q d	$^1J_{CF} = 283$ $^2J_{CF} = 26.3$		a
¹⁹F				
-74.45	m		3	a
-126.75 and -128.97	AB	$J_{AB} = 275$	2	c
-207.82	d m	$^2J_{HF} = 42.9$	1	b

NMR Spectrum 9: 1-(1,1,2,3,3,3-Hexafluoropropyl)-2-(2,2,3,4,4,4-hexafluorobutyl)-cyclohexanol (73).

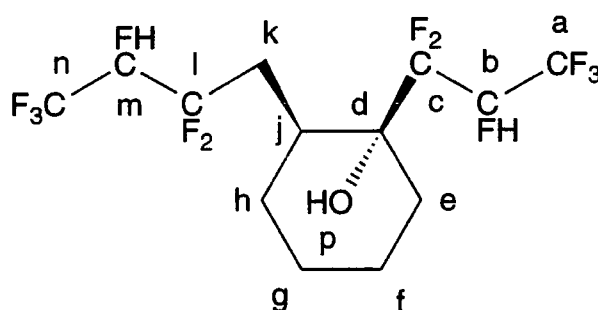

Chemical Shift (ppm)	Multiplicity	Coupling Constants	Relative Intensity	Assignment
¹H				
1.29-1.92	m		10	e,f,g,h,j,p
2.34	m		1	k
2.57	m		1	k
4.66	d m	$^2J_{HF} = 44.0$	1	m
5.08	d d q	$^2J_{HF} = 43.2$ $^3J_{HF1} = 18.8$ $^3J_{HF} = 6.0$	1	b
¹³C				
20.30	s			g
23.31	s			f
29.60	s			h
31.17	s			e
32.79	s			j
32.95	m			k
74.85	m			d
82.84	d d q d	$^1J_{CF} = 197$ $^2J_{CF1} = 37.4$ $^2J_{CF} = 34.4$ $^2J_{CF2} = 23.7$		b
86.36	d q	$^1J_{CF} = 197$ $^2J_{CF1} = 34.0$		m
119.06	br m			c,l
121.06	q d	$^1J_{CF} = 283$ $^2J_{CF} = 26.4$		a,n
¹⁹F				
-73.99	m		3	n
-74.42	m		3	a
-104.37 and -111.71	AB	$J_{AB} = 288$	3	l
-118.43 and -122.27	AB	$J_{AB} = 296$	2	c
-205.66	d m	$^2J_{HF} = 44.0$	1	m
-209.69	d q	$^2J_{HF} = 43.2$ $^3J_{FF} = 11.3$	1	b

NMR Spectrum 10: *Exo*-2-(1,1,2,3,3,3-hexafluoropropyl)-norbornan-2-ol (77).

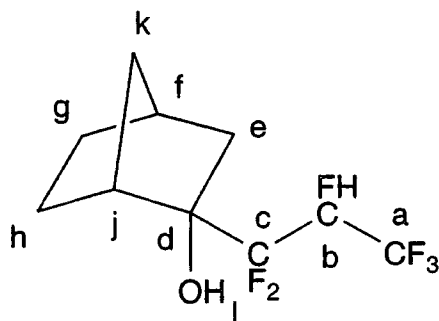

Chemical Shift (ppm)	Multiplicity	Coupling Constant	Relative Intensity	Assignment
¹H				
1.09-2.64	m		11	e,f,g,h,j,k,l
5.27	d d q d	$2J_{HF} = 43.2$ $3J_{HF1} = 17.6$ $3J_{HF} = 6.4$ $3J_{HF2} = 2.0$	1	b
¹³C				
22.48	s			g
27.61	s			h
35.90	s			f
38.96	d	$4J_{CF1} = 5.7$		k
42.23	m			e,j
80.72	t	$2J_{CF} = 25.5$		d
83.60	d d q d	$1J_{CF} = 195$ $2J_{CF1} = 37.7$ $2J_{CF} = 33.9$ $2J_{CF2} = 24.8$		b
118.70	d d d	$1J_{CF1} = 263$ $1J_{CF2} = 249$ $2J_{CF} = 22.1$		c
121.21	q d	$1J_{CF} = 282$ $2J_{CF} = 25.9$		a
¹⁹F				
-74.18	m		3	a
-119.63 and -122.29	AB	$J_{AB} = 282$	2	c
-207.90	d m	$2J_{FH} = 43.2$	1	b

NMR Spectrum 11: 1,x-Di-(1,1,2,3,3,3-hexafluoropropyl)-decahydronaphthan-1-ol (79).

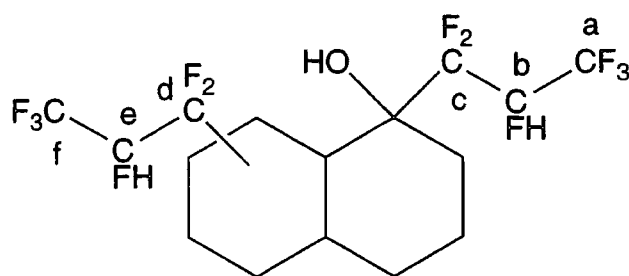

Chemical Shift (ppm)	Multiplicity	Coupling Constants	Relative Intensity	Assignment
¹⁹ F				
-73.81	m		3	a or f
-74.10	m		3	a or f
-113.23 and -122.15	AB	$J_{AB} = 277$	2	d
-118.61 and -121.61	AB	$J_{AB} = 278$	2	c
-209.00	d m	$^2J_{HF} = 40.0$	2	b,d

NMR Spectrum 12: 2-(1,1,2,3,3,3-Hexafluoropropyl)-decahydronaphthan-2-ol (81).

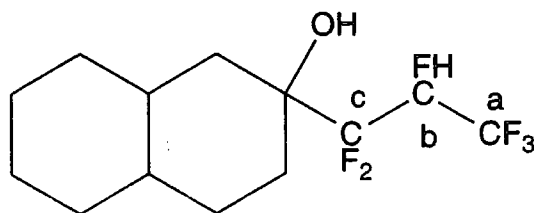

Chemical Shift (ppm)	Multiplicity	Coupling Constants	Relative Intensity	Assignment
¹⁹F				
-74.75	m		3	a
-126.79 and -128.42	AB	$J_{AB} = 272$	2	c
-208.02	d m	${}^2J_{HF} = 42.3$	1	b

Appendix A.iii.: NMR Spectra for Chapter 4.

NMR Spectrum 13: 1,4-Di-(1,1,2,3,3,3-hexafluoropropyl)-cyclohexane-1,4-diol (**85**).

NMR Spectrum 14: 1-(1,1,2,3,3,3-Hexafluoropropyl)-cyclohexane-1,3-diol (**87**).

NMR Spectrum 15: 1,3-Di-(1,1,2,3,3,3-hexafluoropropyl)-cyclohexane-1,3-diol (**88**).

NMR Spectrum 16: 1,3-Di-(1,1,2,3,3,3-hexafluoropropyl)-cyclopentane-1,3-diol (**92**).

NMR Spectrum 17: 4,6-Dimethyl-1,1,2,3,3,3,7,7,8,9,9,9-dodecafluorononan-4,6-diol (**94**).

NMR Spectrum 18: 4,7-Dimethyl-1,1,2,3,3,3,8,8,9,10,10,10-Dodecafluorodecan-4,7-diol (**97**).

NMR Spectrum 19: 1,1,2,3,3,3,7,7,8,9,9,9-Dodecafluorononan-4,6-diol (**100**).

NMR Spectrum 20: 1,1,2,3,3,3,8,8,9,10,10,10-Dodecafluorodecan-4,7-diol (**9**).

NMR Spectrum 21: x-(1,1,2,3,3,3-Hexafluoropropyl)-2-hydroxy tetrahydrofuran (**109**).

NMR Spectrum 22: (1,1,2,3,3,3-Hexafluoropropyl)-furfuryl ether (**112**).

NMR Spectrum 23: 1-(Trans-2-hydro-perfluorocyclopentyl)-cyclopentanol (**114**).

NMR Spectrum 24: 1-(Cis-2-hydro-perfluorocyclopentyl)-cyclopentanol (**114**).

NMR Spectrum 25: 1-(Trans-2-hydro-perfluorocyclohexyl)-cyclopentanol (**115**).

NMR Spectrum 26: 1-(Trans-2-hydro-perfluorocyclohexyl)-cyclohexanol (**116**).

NMR Spectrum 27: 1-(Cis-2-hydro-perfluorocyclohexyl)-cyclohexanol (**116**).

NMR Spectrum 13: 1,4-Di-(1,1,2,3,3,3-hexafluoropropyl)-cyclohexane-1,4-diol (**85**).

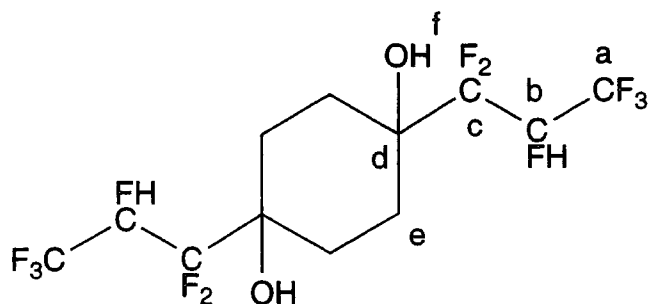

Chemical Shift (ppm)	Multiplicity	Coupling Constant	Relative Intensity	Assignment
¹H				
1.94	m		4	e
5.02	s		1	f
5.77	d m	$^2J_{\text{HF}} = 36.0$	1	b
¹³C				
24.47	m			e
27.81	m			e
72.50	t	$^2J_{\text{CF}} = 23.2$		d
73.15	t	$^2J_{\text{CF}} = 23.6$		d
83.68	d m	$^1J_{\text{CF}} = 193$		b
119.54	d d d	$^1J_{\text{CF1}} = 264$ $^1J_{\text{CF2}} = 250$ $^2J_{\text{CF}} = 26.0$		c
122.56	q d	$^1J_{\text{CF}} = 283$ $^2J_{\text{CF}} = 26.4$		a
¹⁹F				
-74.74	m		3	a
-126.44 and -128.38	AB	$J_{\text{AB}} = 271$	2	c
-208.52	d m	$^2J_{\text{FH}} = 36.0$	1	b

NMR Spectrum 14: 1-(1,1,2,3,3,3-Hexafluoropropyl)-cyclohexane-1,3-diol (**87**).

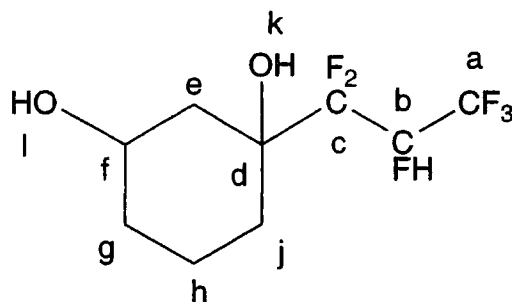

Chemical Shift (ppm)	Multiplicity	Coupling Constant	Relative Intensity	Assignment
¹H				
1.69	m		8	e,g,h,j
2.93	br s		2	l,k
3.88	m		1	f
5.71	m		1	b
¹³C				
19.55	s			h
19.67	s			h
28.52	s			g
28.56	s			g
35.75	s			j
35.85	s			j
38.40	t	$^3J_{CF} = 4.2$		e
39.70	t	$^3J_{CF} = 4.2$		e
66.23	s			f
66.35	s			f
75.91	m			d
83.40	d m	$^1J_{CF} = 180$		b
119.10	d m	$^1J_{CF} = 249$		c
122.53	q d	$^1J_{CF} = 283$ $^2J_{CF} = 26.4$		a
¹⁹F				
-74.72	m		3	a
-126.53 and -128.26	AB	$J_{AB} = 271$		c
-126.27 and -128.39	AB	$J_{AB} = 271$		c
-208.07	m		1	b

NMR Spectrum 15: 1,3-Di-(1,1,2,3,3,3-hexafluoropropyl)-cyclohexane-1,3-diol (**88**).

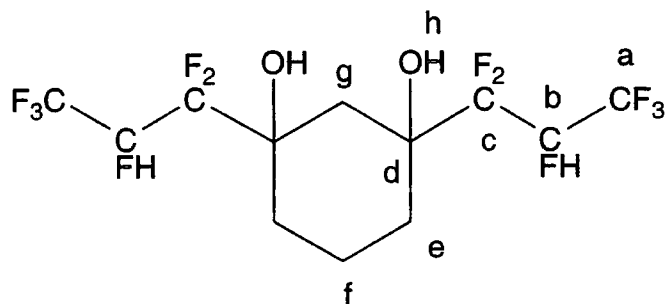

Chemical Shift (ppm)	Multiplicity	Coupling Constant	Relative Intensity	Assignment
¹H				
1.61-2.18	m		4	e,f,g
3.11	s			h
3.50	s			h
3.69	s			h
3.98	s			h
5.11-5.35	m		1	b
¹³C				
14.81	s			f
28.03	m			e
29.31	m			e
29.60	m			g
30.78	m			g
75.27	m			d
82.70	d m	$^1J_{CF} = 196$		b
116.85	m			c
121.01	q m	$^1J_{CF} = 248$		a
¹⁹F				
-73.95	m		3	a
-126.50	m		2	c
-208.07	m		1	b

NMR Spectrum 16: 1,3-Di-(1,1,2,3,3,3-hexafluoropropyl)-cyclopentane-1,3-diol (**92**).

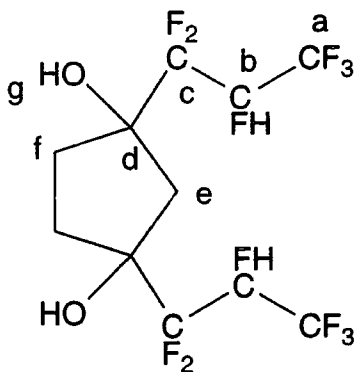

Chemical Shift (ppm)	Multiplicity	Coupling Constant	Relative Intensity	Assignment
¹H				
2.05-2.65	m		3	e,f
5.13-5.31	m		1	g
5.68	d d q	$^2J_{\text{HF}} = 42.8$ $^3J_{\text{HF1}} = 19.2$ $^3J_{\text{HF}} = 6.0$	1	b
¹³C				
33.31	d	$^3J_{\text{CF1}} = 3.4$		f
33.75	t	$^3J_{\text{CF}} = 5.3$		f
34.32	s			f
34.64	s			f
42.74	s			e
43.04	d	$^3J_{\text{CF1}} = 4.2$		e
43.49	t	$^3J_{\text{CF}} = 5.0$		e
82.08-84.08	m			d
84.72-85.67	m			b
119.43	t m	$^1J_{\text{CF}} = 254$		c
122.61	q d	$^1J_{\text{CF}} = 282$ $^2J_{\text{CF}} = 25.5$		a
¹⁹F				
-73.87	m		3	a
-121.05 and -126.29	AB	$J_{\text{AB}} = 282$		c
-121.55 and -125.97	AB	$J_{\text{AB}} = 278$		c
-122.04 and -126.04	AB	$J_{\text{AB}} = 274$		c
-209.94	br d	$^2J_{\text{FH}} = 42.9$	1	b

NMR Spectrum 17: 4,6-Dimethyl-1,1,1,2,3,3,7,7,8,9,9,9-dodecafluorononan-4,6-diol (94).

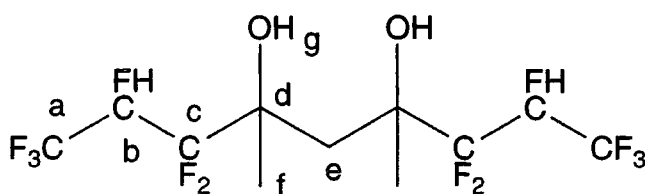

Chemical Shift (ppm)	Multiplicity	Coupling Constants	Relative Intensity	Assignment
¹H				
1.52-1.65	m		6	f
2.03-2.17	m		2	e
3.19	s		1	g
3.34	s		1	g
5.25	d m	$^2J_{HF} = 43.6$	2	b
¹³C				
19.25	s			f
20.25	s			f
20.34	s			f
34.72	s			e
35.41	s			e
75.63	t	$^2J_{CF} = 22.9$		d
75.81	t	$^2J_{CF} = 22.9$		d
83.46	d d d q	$^1J_{CF} = 193$ $^2J_{CF1} = 36.6$ $^2J_{CF2} = 33.2$ $^2J_{CF} = 23.3$		b
118.99	d d d	$^1J_{CF1} = 266$ $^1J_{CF2} = 252$ $^2J_{CF} = 20.6$		c
119.44	d d d	$^1J_{CF1} = 267$ $^1J_{CF2} = 253$ $^2J_{CF} = 20.2$		c
122.48	q d	$^1J_{CF} = 282$ $^2J_{CF} = 26.3$		a
¹⁹F				
-73.92	m		3	a
-73.93	m		3	a
-120.92 and -126.12	AB	$J_{AB} = 274$	2	c
-122.29 and -126.82	AB	$J_{AB} = 277$	2	c
-206.40	br m		2	b

NMR Spectrum 18: 4,7-Dimethyl-1,1,1,2,3,3,3,8,8,9,10,10,10-dodecafluorodecan-4,7-diol (**97**).

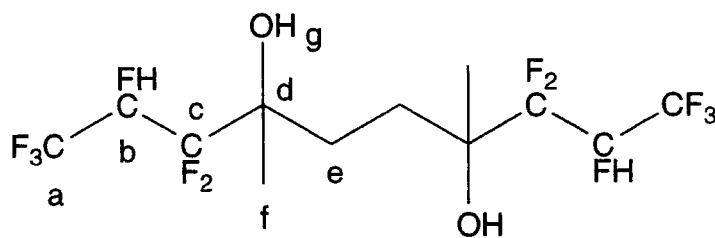

Chemical Shift (ppm)	Multiplicity	Coupling Constants	Relative Intensity	Assignment
¹H				
1.30-1.42	m		3	f
1.75-1.96	m		2	e
2.21-2.62	m		1	g
5.23	d m	$^2J_{HF} = 43.6$	1	b
¹³C				
19.07	s			f
19.51	s			f
20.24	s			f
26.39	s			e
27.87	s			e
28.17	s			e
74.50	m			d
83.07	d m	$^1J_{CF} = 196$		b
118.36	m			c
122.96	q d	$^1J_{CF} = 283$ $^2J_{CF} = 26.4$		a
¹⁹F				
-74.01	m		3	a
-121.29 to -127.05	m		2	c
-206.98	m		1	b

NMR Spectrum 19: 1,1,1,2,3,3,7,7,8,9,9,9-Dodecafluorononan-4,6-diol (**100**).

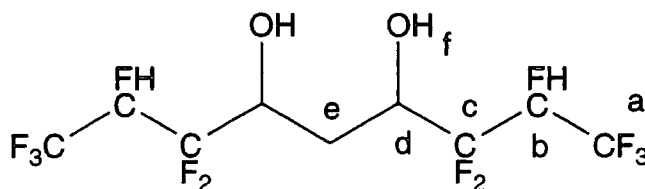

Chemical Shift (ppm)	Multiplicity	Coupling Constants	Relative Intensity	Assignment
¹H				
2.02	s		2	e
3.60	s		2	f
4.08	m		1	d
4.31	m		1	d
5.13	d m	$^2J_{HF} = 46.4$	2	b
¹³C				
27.83	m			e
65.95	m			d
67.67	m			d
83.74	d m	$^1J_{CF} = 196$		b
117.62	m			c
120.72	q m	$^1J_{CF} = 291$		a
¹⁹F				
-74.30	m		3	a
-74.61	m		3	a
-120.65 and -125.51	AB	$J_{AB} = 275$	2	c
-126.30 and -129.82	AB	$J_{AB} = 272$	2	c
-212.99	m		1	b
-214.50	m		1	b

NMR Spectrum 20: 1,1,1,2,3,3,8,8,9,10,10,10-Dodecafluoroedecan-4,7-diol (**9**).

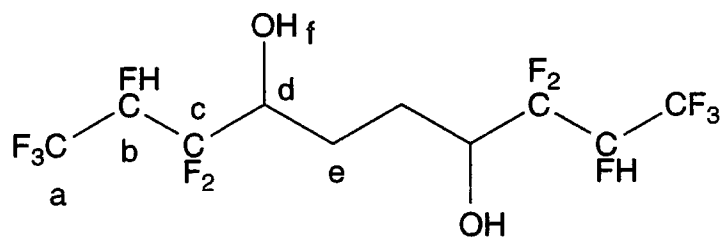

	Chemical Shift (ppm)	Multiplicity	Coupling Constants	Relative Intensity	Assignment
¹H	2.31	m		2	e
	4.29	m		1	d
	5.21	d m	$^2J_{\text{HF}} = 44.6$	1	b
¹⁹F	-74.82	m		3	a
	-74.96	m		3	a
	-124.36	m		4	c
	-213.64	m		1	b
	-215.90	m		1	b

NMR Spectrum 21: α -(1,1,2,3,3,3-Hexafluoropropyl)-2-hydroxy tetrahydrofuran (109).

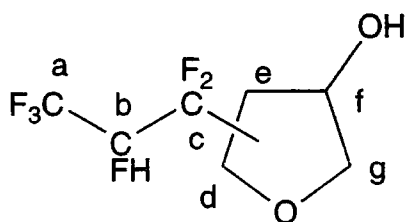

Chemical Shift (ppm)	Multiplicity	Coupling Constants	Relative Intensity	Assignment
¹⁹F				
-72.09	m			a
-115.89 to -123.61	m			c
-123.00 and -127.04	AB	$J_{AB} = 280$		c
-207.56				b
-211.31	d m	${}^3J_{FF} = 46.1$		b
-214.85	d m	${}^3J_{FF} = 45.6$		b

NMR Spectrum 22: (1,1,1,2,3,3-Hexafluoropropyl)-furfuryl ether (112).

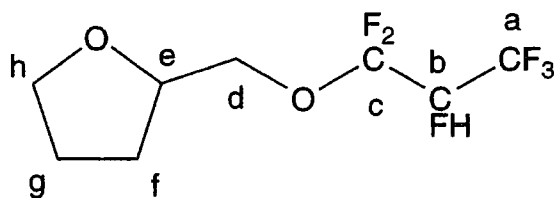

Chemical Shift (ppm)	Multiplicity	Coupling Constants	Relative Intensity	Assignment
¹H				
1.67	m		1	g
1.90	m		2	f,g
2.00	m		1	f
3.78 and 3.86	AB	$J_{AB} = 6.8$	2	h
3.95	m		2	d
4.12	m		1	e
4.81	d q d	$^2J_{HF} = 44.0$ $^3J_{HF} = 6.0$ $^3J_{HF1} = 1.2$	1	b
¹³C				
25.56	s			g
27.73	s			f
66.34	s			d
68.63	s			h
76.05	s			e
84.72	d sext	$^1J_{CF} = 200$ $^2J_{CF} = 33.9$		b
118.41	t d	$^1J_{CF} = 268$ $^2J_{CF} = 22.5$		c
120.02	q d	$^1J_{CF} = 282$ $^2J_{CF} = 22.5$		a
¹⁹F				
-75.72	m		3	a
-82.23	m		2	c
-212.14	m		1	b

NMR Spectrum 23: 1-(*Trans*-2-hydro-perfluorocyclopentyl)-cyclopentanol (**114**).

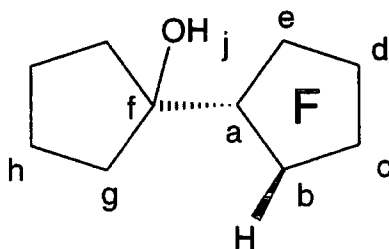

Chemical Shift (ppm)	Multiplicity	Coupling Constants	Relative Intensity	Assignment
¹H				
1.66-2.10	m		9	g,h,j
5.19	d d t t	$^2J_{HF} = 47.6$ $^3J_{HF} = 11.6$ $^3J_{HF} = 9.6$ $^4J_{HF} = 4.8$	1	b
¹³C				
23.48	s			h
23.68	s			h
36.21	s			g
36.87	s			g
82.80	d	$^2J_{CF} = 21.7$		f
90.86	d d d d	$^1J_{CF} = 209$ $^2J_{CF} = 39.2$ $^2J_{CF1} = 34.2$ $^2J_{CF2} = 18.3$ $^1J_{CF} = 192$		b
95.41	d m			a
108.23-117.56	m			c,d,e
¹⁹F				
-122.47 and -126.57	AB	$J_{AB} = 264$	2	e
-122.57 and -128.57	AB	$J_{AB} = 264$	2	d
-126.61 and -135.45	AB	$J_{AB} = 255$	2	c
-166.55	s		1	a
-210.04	d	$^2J_{FH} = 47.6$	1	b

NMR Spectrum 24: 1-(*Cis*-2-hydro-perfluorocyclopentyl)-cyclopentanol (114).

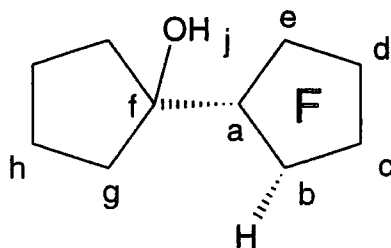

Chemical Shift (ppm)	Multiplicity	Coupling Constants	Relative Intensity	Assignment
¹H				
1.65-2.20	m		9	g,h,j
5.50	d d t t	$^2J_{HF} = 46.4$ $^3J_{HF} = 18.8$ $^3J_{HF} = 11.2$ $^4J_{HF} = 3.6$	1	b
¹³C				
23.13	s			h
23.48	s			h
34.84	s			g
35.62	s			g
81.00	d	$^2J_{CF} = 25.0$		f
85.35	d d t	$^1J_{CF} = 216$ $^2J_{CF} = 30.0$ $^2J_{CF} = 16.1$ $^1J_{CF} = 208$		b
92.22	d m			a
107.76-119.00	m			c,d,e
¹⁹F				
-120.12 and -129.11	AB	$J_{AB} = 252$	2	e
-122.78 and -127.97	AB	$J_{AB} = 266$	2	d
-130.15 and -132.03	AB	$J_{AB} = 254$	2	c
-187.44	s		1	a
-224.29	d	$^2J_{FH} = 46.4$	1	b

NMR Spectrum 25: 1-(*Trans*-2-hydro-perfluorocyclohexyl)-cyclopentanol (115).

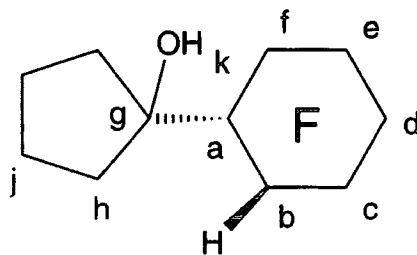

Chemical Shift (ppm)	Multiplicity	Coupling Constants	Relative Intensity	Assignment
¹H				
1.67-2.19	m		8	h,j
4.32	s		1	k
5.48-5.70	m		1	b
¹³C				
21.94	d	$^4J_{CF} = 2.7$		j
22.43	d	$^4J_{CF} = 2.7$		j
35.34	d	$^3J_{CF} = 8.7$		h
36.79	d	$^3J_{CF} = 7.9$		h
83.27	d	$^2J_{CF} = 25.6$		g
83.53	d m	$^1J_{CF} = 206$		b
91.71	d d	$^1J_{CF} = 209$ $^2J_{CF} = 21.3$		a
104.99-114.61	m			c,d,e,f
¹⁹F				
-119.98 and -128.84	AB	$J_{AB} = 290$	2	c,d,e, or f
-123.25 and -140.03	AB	$J_{AB} = 282$	2	c,d,e, or f
-123.89 and -145.13	AB	$J_{AB} = 286$	2	c,d,e, or f
-127.36 and -128.20	AB	$J_{AB} = 263$	2	c,d,e, or f
-191.76	s		1	a
-226.71	d d	$^2J_{FH} = 41.4$ $^3J_{FF} = 10.5$	1	b

NMR Spectrum 26: 1-(Trans-2-hydro-perfluorocyclohexyl)-cyclohexanol (**116**).

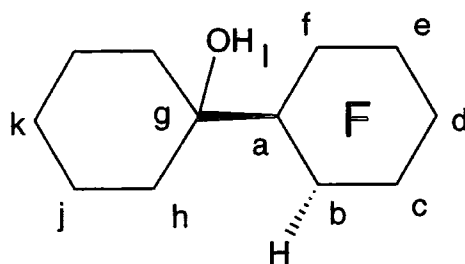

Chemical Shift (ppm)	Multiplicity	Coupling Constants	Relative Intensity	Assignment
¹H				
1.22-2.03	m		11	h,j,k,l
5.45-5.58	m		1	b
¹³C				
20.68	s			j
21.09	s			j
24.97	s			k
31.33	m			h
32.23	m			h
83.62	m			g
85.42	m			b
92.03	m			a
103.92-111.26	m			c,d,e,f
¹⁹F				
-115.58 and -127.40	AB	$J_{AB} = 293$	2	c,d,e or f
-116.72 and -128.96	AB	$J_{AB} = 295$	2	c,d,e or f
-122.10 and -139.76	AB	$J_{AB} = 280$	2	c,d,e or f
-123.40 and -140.20	AB	$J_{AB} = 293$	2	c,d,e or f
-187.06	m		1	a
-207.83	d m	${}^2J_{FH} = 32.0$	1	b

NMR Spectrum 27: 1-(*Cis*-2-hydro-perfluorocyclohexyl)-cyclohexanol (**116**).

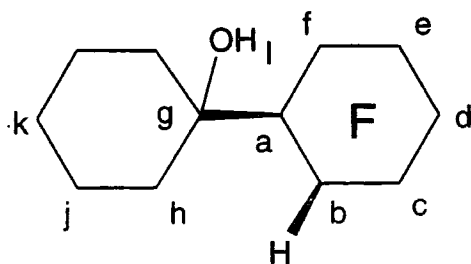

Chemical Shift (ppm)	Multiplicity	Coupling Constants	Relative Intensity	Assignment
¹H				
1.17-2.11	m		11	h,j,k,l
5.41-5.64	m		1	b
¹³C				
20.94	s			j
21.54	s			j
24.72	s			k
31.86	d	$^3J_{CF} = 4.9$		h
33.13	d	$^3J_{CF} = 6.8$		h
83.74	m			g
84.68	d m	$^1J_{CF} = 206$		b
93.51	d m	$^1J_{CF} = 211$		a
103.32-112.95	m			c,d,e,f
¹⁹F				
-120.60 and -126.36	AB	$J_{AB} = 294$	2	c,d,e or f
-123.09 and -139.85	AB	$J_{AB} = 282$	2	c,d,e or f
-124.28 and -145.40	AB	$J_{AB} = 284$	2	c,d,e or f
-127.72 and -128.32	AB	$J_{AB} = 278$	2	c,d,e or f
-194.65	s		1	a
-225.87	d m	$^2J_{FH} = 41.7$	1	b

Appendix A.iv.: NMR Spectra for Chapter 5.

NMR Spectrum 28: 1-(1,2,3,3,3-Pentafluoro-E-prop-1-enyl)-cyclohexanol (119).

NMR Spectrum 29: 1-(1,2,3,3,3-Pentafluoro-E-prop-1-enyl)-cyclopentanol (124).

NMR Spectrum 30: 1-(1,1,2,3,3,3-Hexafluoropropyl)-cyclopentyl acetate (126).

NMR Spectrum 31: 1,1,1,2,3,3,7,7,8,9,9,9-Dodecafluoro-4,6-dimethylnonan-4,6-diacetate (127).

NMR Spectrum 32: 1-(1,1,2,3,3,3-Hexafluoropropyl)-cyclopentyl benzoate (129).

NMR Spectrum 33: 1-(1,1,2,3,3,3-Hexafluoropropyl)-cyclopentyl methacrylate (131).

NMR Spectrum 34: 1-(1,2,3,3,3-Pentafluoro-Z-prop-1-enyl)-cyclopentyl acetate (132).

NMR Spectrum 35: 1-(1,1,2,3,3,3-Hexafluoropropyl)-cyclohexyltrimethyl silane (140).

NMR Spectrum 36: 1-(1,1,2,3,3,3-Hexafluoropropyl)-cyclohexene (142).

NMR Spectrum 37: 1-(1,1,2,3,3,3-Hexafluoropropyl)-cyclopentene (143).

NMR Spectrum 38: 1-(1,1,2,3,3,3-Hexafluoropropyl)-cycloheptene (144).

NMR Spectrum 39: 1-(1,1,2,3,3,3-Hexafluoropropyl)-norbornane (145).

NMR Spectrum 40: 1-(*Trans*-2-hydro-perfluorocyclopentyl)-cyclopentene (146).

NMR Spectrum 41: 1-(*Cis*-2-hydro-perfluorocyclopentyl)-cyclopentene (146).

NMR Spectrum 42: 1-(2-Hydro-perfluorocyclohexyl)-cyclohexene (147).

NMR Spectrum 43: 1,x-Di-(1,1,2,3,3,3-hexafluoropropyl)-cyclopentadiene (x = 3,4) (148).

NMR Spectrum 44: 1-(1,1,2,3,3,3-Hexafluoropropyl)-1,2-dibromocyclohexane (149).

NMR Spectrum 45: 1-(1,1,2,3,3,3-Hexafluoropropyl)-1,2-dibromocyclopentane (150).

NMR Spectrum 46: 1-(1,1,2,3,3,3-Hexafluoropropyl)-5-bromocyclopentene (151).

NMR Spectrum 47: 1-(1,1,2,3,3,3-Hexafluoropropyl)-cyclopentene epoxide (152).

NMR Spectrum 48: 1-(1,1,2,3,3,3-Hexafluoropropyl)-cyclohexene epoxide (153).

NMR Spectrum 49: 1-(1,1,2,3,3,3-Hexafluoropropyl)-cyclohexane-1,2-diol (154).

NMR Spectrum 50: 1-(1,1,2,3,3,3-Hexafluoropropyl)-3,5-dibromo-cyclohexene (155).

NMR Spectrum 51: (1,1,2,3,3,3-Hexafluoropropyl)-benzene (156).

NMR Spectrum 52: 2-Bromo-(1,1,2,3,3,3-hexafluoropropyl)-benzene (157).

NMR Spectrum 53: 1-(1,2,3,3,3-Pentafluoro-Z-prop-1-enyl)-cyclopentene (159).

NMR Spectrum 54: 1-(1,2,3,3,3-Pentafluoro-Z-prop-1-enyl)-cyclohexene (160).

NMR Spectrum 55: 1-(Perfluorocyclopent-1-enyl)-cyclopentene (161).

NMR Spectrum 56: 1-(Perfluorocyclopent-2-enyl)-cyclopentene.

NMR Spectrum 57: 1-(2,3,3,3-Tetrafluoro-1-methoxy-prop-1-enyl)-cyclopentene (163).

NMR Spectrum 58: 1-(2,3,3,3-Tetrafluoro-1-propoxy-prop-1-enyl)-cyclopentene (164).

NMR Spectrum 59: 1-(2,3,3,3-Tetrafluoro-1-phenylmethoxy-prop-1-enyl)-cyclopentene (165).

NMR Spectrum 60: 1-(1,2,3,3,3-Pentafluoro-Z-prop-1-enyl)-cyclohexene epoxide (166).

NMR Spectrum 61: 1-(1,2,3,3,3-Pentafluoro-Z-prop-1-enyl-epoxide)-cyclohexene epoxide (167).

NMR Spectrum 28: 1-(1,2,3,3,3-Pentafluoro-E-prop-1-enyl)-cyclohexanol (**119**).

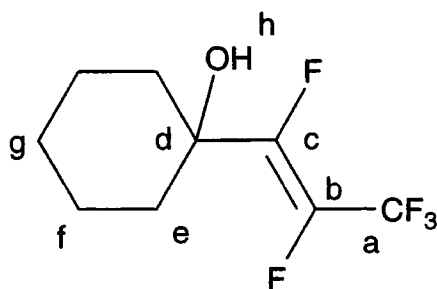

Chemical Shift (ppm)	Multiplicity	Coupling Constants	Relative Intensity	Assignment
¹H				
1.29-1.89	m		10	e,f,g
2.18	br s		1	h
¹³C				
21.08	s			g
24.93	s			f
34.02	s			e
72.64	d d	$^2J_{CF} = 22.1$ $^3J_{CF} = 3.8$		d
118.93	q d d	$^1J_{CF} = 273$ $^2J_{CF} = 36.3$ $^3J_{CF} = 3.4$		a
138.09	d d q	$^1J_{CF} = 247$ $^2J_{CF} = 50.0$ $^2J_{CF} = 40.0$		b
157.44	d d	$^1J_{CF} = 265$ $^2J_{CF} = 37.8$		c
¹⁹F				
-67.56	d d	$^3J_{FF} = 22.4$ $^4J_{FF} = 10.2$	3	a
-149.38	d q	$^3J_{FF} = 135$	1	b
-170.12	d	$^3J_{FF} = 22.4$ $^3J_{FF} = 135$	1	c

NMR Spectrum 29: 1-(1,2,3,3,3-Pentafluoro-E-prop-1-enyl)-cyclopentanol (124).

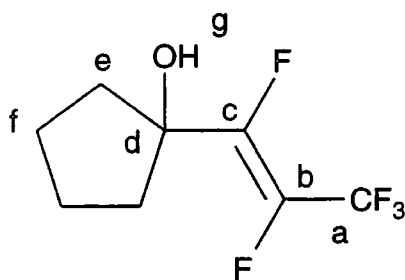

Chemical Shift (ppm)	Multiplicity	Coupling Constants	Relative Intensity	Assignment
¹H				
1.78-2.09	m			e,f,g
¹³C				
22.74	s			f
37.56	m			e
80.33	d d	$^2J_{CF} = 23.6$ $^3J_{CF} = 4.2$		d
118.74	q d	$^1J_{CF} = 273$ $^2J_{CF} = 36.2$		a
137.43	d d q	$^1J_{CF} = 245$ $^2J_{CF} = 49.3$ $^2J_{CF} = 39.6$		b
156.63	d d	$^1J_{CF} = 263$ $^2J_{CF} = 37.4$		c
¹⁹F				
-67.69	d d	$^3J_{FF} = 22.6$ $^4J_{FF} = 10.5$	3	a
-144.71	d q	$^3J_{FF} = 135$ $^3J_{FF} = 22.6$	1	b
-169.92	d q	$^3J_{FF} = 135$ $^4J_{FF} = 10.5$	1	c

NMR Spectrum 30: 1-(1,1,2,3,3,3-Hexafluoropropyl)-cyclopentyl acetate (126).

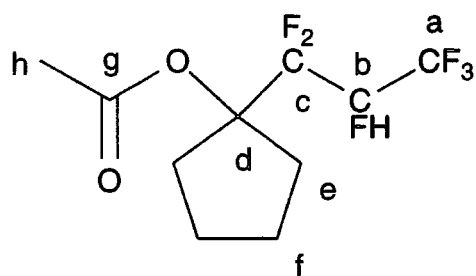

	Chemical Shift (ppm)	Multiplicity	Coupling Constants	Relative Intensity	Assignment
¹H	1.65	m		2	f
	2.04	m		5	f and h
	2.17	m		4	e
	5.15	d d q d	$^2J_{\text{HF}} = 42.6$ $^3J_{\text{HF1}} = 18.8$ $^3J_{\text{HF}} = 6.0$ $^3J_{\text{HF2}} = 2.0$	1	b
¹³C	21.85	s			h
	25.40	s			f
	26.14	s			f
	32.49	s			e
	32.64	s			e
	84.40	d d q d	$^1J_{\text{CF}} = 197$ $^2J_{\text{CF1}} = 40.0$ $^2J_{\text{CF}} = 34.3$ $^2J_{\text{CF2}} = 24.8$		b
	91.83	d d	$^2J_{\text{CF1}} = 30.9$ $^2J_{\text{CF2}} = 23.2$		d
	117.51	d d d	$^1J_{\text{CF1}} = 258$ $^1J_{\text{CF2}} = 252$ $^2J_{\text{CF}} = 22.5$		c
120.93	q d	$^1J_{\text{CF}} = 282$ $^2J_{\text{CF}} = 25.9$		a	
168.45	s			g	
¹⁹F	-74.29	m		3	a
	-116.57 and -125.88	AB	$J_{\text{AB}} = 277$	2	c
	-208.76	d m	$^2J_{\text{FH}} = 42.5$	1	b

NMR Spectrum 31: 1,1,1,2,3,3,7,7,8,9,9,9-Dodecafluoro-4,6-dimethylnonan-4,6-diacetate (**127**).

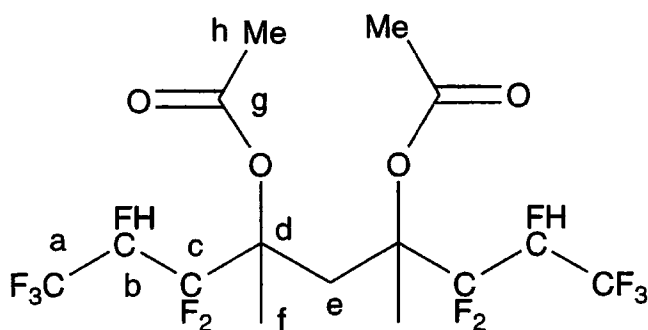

Chemical Shift (ppm)	Multiplicity	Coupling Constants	Relative Intensity	Assignment
¹H				
1.82	m		3	f
2.02	m		3	h
2.66-2.82	m		1	e
5.06-5.38	m		1	b
¹³C				
18.33	m			f
18.74	m			f
19.37	m			f
19.73	m			f
21.75	s			e
21.80	s			h
21.87	s			h
21.89	s			h
35.77	m			e
35.94	m			e
36.34	m			e
82.50-85.15	m			b
83.22	m			d
113.89-119.09	m			c
120.76	q d	¹ J _{CF} = 283 ² J _{CF} = 25.9		a
168.97	s			g
169.04	s			g
169.28	s			g
¹⁹F				
-74.16	m		3	a
-117.31 to -118.90	m		1	c
-122.32 to -123.49	m		1	c
-205.88 to -207.28	m		1	b

NMR Spectrum 32: 1-(1,1,2,3,3,3-Hexafluoropropyl)-cyclopentyl benzoate (**129**).

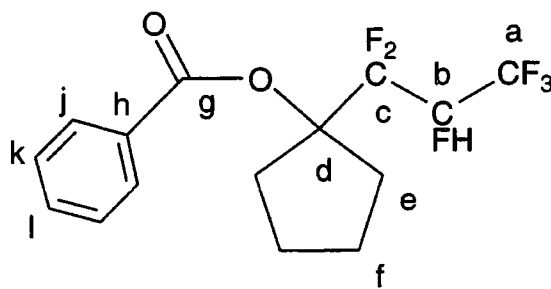

	Chemical Shift (ppm)	Multiplicity	Coupling Constants	Relative Intensity	Assignment	
¹ H	1.76	m		2	f	
	2.16	m		2	f	
	2.32	m		2	e	
	2.40	m		2	e	
	5.32	d d q d	² J _{HF} = 43.6 ³ J _{HF1} = 18.8 ³ J _{HF} = 6.0 ³ J _{HF2} = 2.0	1	b	
	7.59	t	³ J _{HH} = 7.2	1	l	
	7.68	t	³ J _{HH} = 7.2	2	k	
	8.11	m		2	j	
	¹³ C	25.45	s			f
		26.08	s			f
32.56		s			e	
32.74		s			e	
84.43		d d q d	¹ J _{CF} = 198 ² J _{CF1} = 39.7 ² J _{CF} = 33.9 ² J _{CF2} = 24.3		b	
92.36		d d	² J _{CF1} = 30.9 ² J _{CF2} = 24.4		d	
117.51		d d d	¹ J _{CF1} = 260 ¹ J _{CF2} = 252		c	
120.93		q d	² J _{CF} = 22.4 ¹ J _{CF} = 283 ² J _{CF} = 25.8		a	
128.55		s			k	
129.43		s			j	
130.14		s			h	
133.39		s			l	
168.45		s			g	
¹⁹ F		-73.99	m		3	a
	-116.55 and -124.81	AB	J _{AB} = 278	2	c	
	-207.57	d m	² J _{FH} = 43.6	1	b	

NMR Spectrum 33: 1-(1,1,2,3,3,3-Hexafluoropropyl)-cyclopentyl-methacrylate (**131**).

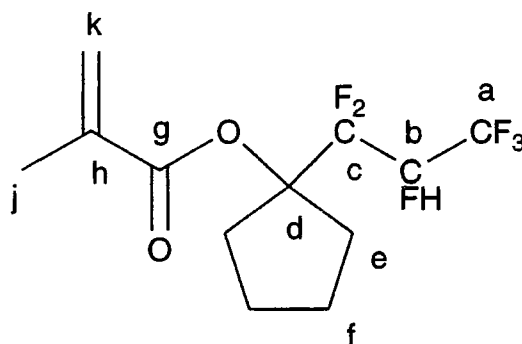

Chemical Shift (ppm)	Multiplicity	Coupling Constants	Relative Intensity	Assignment
¹H				
1.63	m		3	e or f
1.85	s		3	j
1.98-2.19	m		5	e or f
5.16	d d q d	$^2J_{HF} = 43.6$ $^3J_{HF1} = 18.8$ $^3J_{HF} = 6.4$ $^3J_{HF2} = 2.4$	1	b
5.54	s		1	k
5.96	s		1	k
¹³C				
18.22	s			j
25.48	s			f
26.19	s			f
30.35	s			e
32.52	s			e
84.44	d m	$^1J_{CF} = 198$		b
91.92	d d	$^2J_{CF1} = 30.5$ $^2J_{CF2} = 24.8$		d
117.51	d d d	$^1J_{CF1} = 259$ $^1J_{CF2} = 253$ $^2J_{CF} = 23.6$		c
120.88	q d	$^1J_{CF} = 283$ $^2J_{CF} = 25.5$		a
126.39	s			k
136.47	s			h
164.87	s			g
¹⁹F				
-74.11	m		3	a
-116.54 and -125.34	AB	$J_{AB} = 277$	2	c
-207.96	d m	$^2J_{FH} = 43.6$	1	b

NMR Spectrum 34: (1,2,3,3,3-Pentafluoro-Z-prop-1-enyl)-cyclopentyl acetate (132).

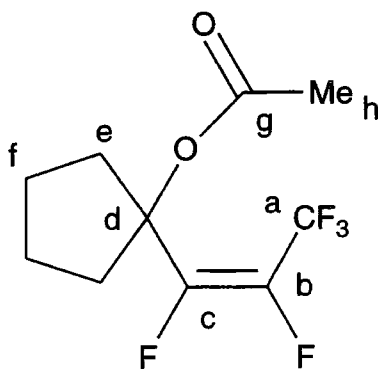

	Chemical Shift (ppm)	Multiplicity	Coupling Constants	Relative Intensity	Assignment
¹H	1.76	m		4	f
	2.01	m		3	h
	2.21	m		4	e
¹³C	21.23	s			f
	23.28	s			h
	37.22	s			e
	84.96	d	$^2J_{CF} = 25.6$		d
	119.20	q d d	$^1J_{CF} = 270$ $^2J_{CF} = 34.7$ $^3J_{CF} = 8.4$		a
	136.62	d m	$^1J_{CF} = 295$		b
	154.90	d m	$^1J_{CF} = 274$		c
169.84	s			g	
¹⁹F	-66.16	m		3	a
	-119.96	m		1	c
	-156.16	m		1	b

NMR Spectrum 35: 1-(1,1,2,3,3,3-Hexafluoropropyl)-cyclohexyltrimethyl silane (140).

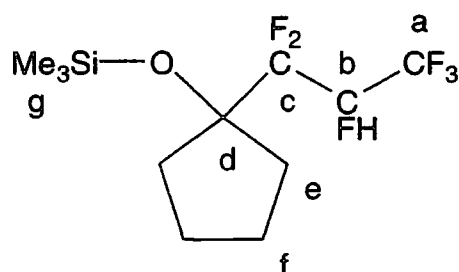

Chemical Shift (ppm)	Multiplicity	Coupling Constants	Relative Intensity	Assignment
¹H				
0.17	s		9	g
1.62-2.18	m		8	e, f
4.10	d d q d	$^2J_{HF} = 43.2$ $^3J_{HF1} = 18.4$ $^3J_{HF} = 6.4$ $^3J_{HF2} = 1.2$	1	b
¹³C				
1.76	s			g
23.67	s			f
24.65	s			f
33.79	s			e
36.04	s			e
82.32	d d q d	$^1J_{CF} = 195$ $^2J_{CF1} = 38.9$ $^2J_{CF} = 34.0$ $^2J_{CF2} = 24.0$		b
86.26	d d	$^2J_{CF1} = 28.6$ $^2J_{CF2} = 22.5$		d
118.32	d d d	$^1J_{CF1} = 261$ $^1J_{CF2} = 251$ $^2J_{CF} = 23.3$		c
121.33	q d	$^1J_{CF} = 283$ $^2J_{CF} = 26.3$		a
¹⁹F				
-74.59	m		3	a
-120.31 and -127.13	AB	$J_{AB} = 261$	2	c
-209.51	d m	$^2J_{HF} = 43.2$	1	b

NMR Spectrum 36: 1-(1,1,2,3,3,3-Hexafluoropropyl)-cyclohexene (142).

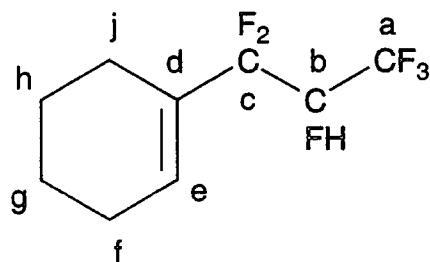

Chemical Shift (ppm)	Multiplicity	Coupling Constants	Relative Intensity	Assignment
¹H				
1.58-1.76	m		4	g,h
2.12-2.20	m		4	f,j
5.60	d m	$^2J_{HF} = 42.4$	1	b
6.30	m		1	e
¹³C				
22.03	s			g
22.47	s			h
23.44	s			j
25.29	s			f
86.15	d d q d	$^1J_{CF} = 194$ $^2J_{CF1} = 36.6$ $^2J_{CF} = 33.2$ $^2J_{CF2} = 30.9$		b
117.84	d d d	$^1J_{CF1} = 249$ $^1J_{CF2} = 246$ $^2J_{CF} = 22.1$		c
122.11	q d d	$^1J_{CF} = 282$ $^2J_{CF} = 26.4$ $^3J_{CF} = 3.0$		a
130.26	t	$^2J_{CF} = 21.7$		d
132.09	t	$^3J_{CF} = 9.2$		e
¹⁹F				
-74.90	m		3	a
-110.95 and -113.72	AB	$J_{AB} = 261$	2	c
-212.82	d q	$^2J_{FH} = 42.4$ $^3J_{FF} = 13.9$	1	b

NMR Spectrum 37: 1-(1,1,2,3,3,3-Hexafluoropropyl)-cyclopentene (143).

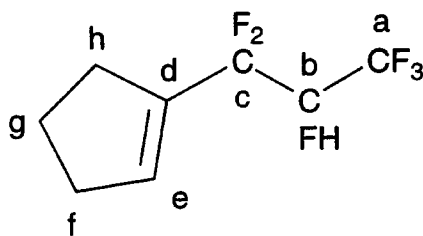

	Chemical Shift (ppm)	Multiplicity	Coupling Constants	Relative Intensity	Assignment	
¹H	2.00	pent	$^3J_{HH} = 7.6$	2	g	
	2.48	m		4	f,h	
	4.84	d m	$^2J_{HF} = 44.0$	1	b	
	6.22	m		1	e	
¹³C	23.17	s			g	
	30.78	d	$^3J_{CF} = 1.5$		h	
	32.65	s			f	
	86.23	d pent d	$^1J_{CF} = 198$ $^2J_{CF} = 36.6$ $^2J_{CF} = 33.6$		b	
	115.56	t d	$^1J_{CF} = 248$ $^2J_{CF} = 22.8$		c	
	120.63	q d d	$^1J_{CF} = 282$ $^2J_{CF} = 26.0$ $^3J_{CF} = 2.6$		a	
	134.99	t	$^2J_{CF} = 24.0$		d	
	138.81	t	$^3J_{CF} = 7.2$		e	
	¹⁹F	-74.62	m		3	a
		-104.50 and -109.46	AB	$J_{AB} = 274$	2	c
-209.97		d q	$^2J_{FH} = 44.0$ $^3J_{FF} = 13.5$	1	b	

NMR Spectrum 38: 1-(1,1,2,3,3,3-Hexafluoropropyl)-cycloheptene (144).

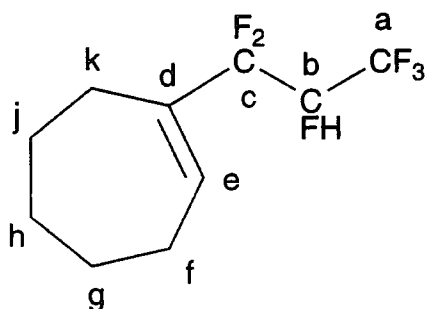

Chemical Shift (ppm)	Multiplicity	Coupling Constants	Relative Intensity	Assignment
¹H				
1.50-1.58	m		4	g,j
1.78-1.82	m		2	h
2.27-2.35	m		4	f,k
5.58	d m	$^2J_{HF} = 42.4$	1	b
6.46	t t	$^3J_{HH} = 6.4$ $^4J_{HF} = 2.4$	1	e
¹³C				
26.44	s			h
26.97	s			j
27.57	s			g
28.58	s			k
32.70	s			f
86.10	d q m	$^1J_{CF} = 194$ $^2J_{CF} = 31.6$		b
118.42	d d d	$^1J_{CF1} = 250$ $^1J_{CF2} = 245$ $^2J_{CF} = 24.4$		c
121.94	q d	$^1J_{CF} = 282$ $^2J_{CF} = 25.9$		a
136.02	t	$^2J_{CF} = 20.2$		d
137.09	d	$^3J_{CF} = 8.4$		e
¹⁹F				
-69.52	m		3	a
-105.46 and -108.70	AB	$J_{AB} = 254$	2	c
-206.88	m		1	b

NMR Spectrum 39: 2-(1,1,2,3,3,3-Hexafluoropropyl)-norbornene (145).

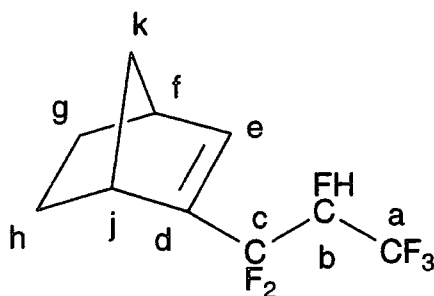

Chemical Shift (ppm)	Multiplicity	Coupling Constants	Relative Intensity	Assignment
¹H				
1.03-2.42	m			f,g,h,j,k
3.89	d m	$^3J_{HH} = 7.2$		e
4.82	d m	$^2J_{HF} = 44.0$		b
¹³C				
26.71	s			g
28.09	s			g
31.17	s			h
33.00	s			h
35.06	s			f
36.52	s			f
43.58	s			k
46.01	s			k
62.50	s			j
86.44	d q	$^1J_{CF} = 197$ $^2J_{CF} = 37.4$		b
116.65	m			c
120.77	q d	$^1J_{CF} = 283$ $^2J_{CF} = 24.7$		a
139.39	m			d
151.01	s			e
¹⁹F				
-74.25	m			a
-103.07 and -108.17	AB	$J_{AB} = 272$		c
-209.89	d q	$^2J_{FH} = 44.0$ $^3J_{FF} = 11.7$		b

NMR Spectrum 40: 1-(*Trans*-2-hydro-perfluorocyclopentyl)-cyclopentene (146).

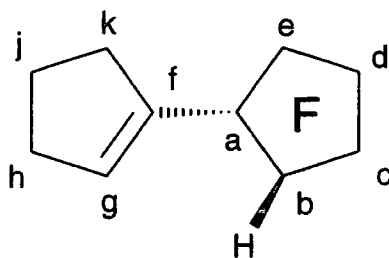

Chemical Shift (ppm)	Multiplicity	Coupling Constants	Relative Intensity	Assignment
¹H				
1.99	pent	$^3J_{HH} = 7.6$	2	j
2.53	m		4	h,k
5.00	d m	$^2J_{HF} = 47.6$	1	b
6.33	s		1	g
¹³C				
22.87	s			j
31.94	s			h or k
33.32	s			h or k
89.92	m			a,b
108.32-117.92	m			c,d,e
130.12	d	$^2J_{CF} = 19.5$		f
138.21	d	$^3J_{CF} = 8.8$		g
¹⁹F				
-116.01 and -124.45	AB	$J_{AB} = 259$	2	c,d or e
-120.49 and -132.34	AB	$J_{AB} = 263$	2	c,d or e
-123.18 and -131.50	AB	$J_{AB} = 248$	2	c,d or e
-164.86	s		1	a
-203.81	d m	$^2J_{HF} = 47.6$	1	b

NMR Spectrum 41: 1-(*Cis*-2-hydro-perfluorocyclopentyl)-cyclopentene (**146**).

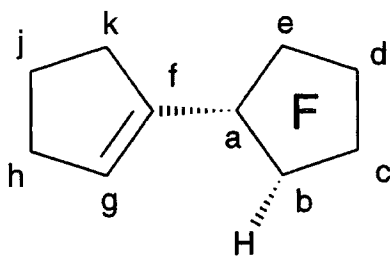

Chemical Shift (ppm)	Multiplicity	Coupling Constants	Relative Intensity	Assignment
¹H				
1.99	pent	$^3J_{HH} = 7.6$	2	j
2.53	m		4	h,k
5.00	d m	$^2J_{HF} = 47.6$	1	b
6.21	s		1	g
¹³C				
23.20	s			j
31.73	s			h or k
33.18	s			h or k
89.92	m			a,b
108.32-117.92	m			c,d,e
131.02	d	$^2J_{CF} = 21.8$		f
137.79	d	$^3J_{CF} = 8.0$		g
¹⁹F				
-113.47 and -126.04	AB	$J_{AB} = 249$	2	c,d or e
-118.58 and -137.95	AB	$J_{AB} = 267$	2	c,d or e
-125.07 and -130.03	AB	$J_{AB} = 253$	2	c,d or e
-180.57	s		1	a
-225.81	d m	$^2J_{HF} = 47.6$	1	b

NMR Spectrum 42: 1-(2-Hydro-perfluorocyclohexyl)-cyclohexene (147).

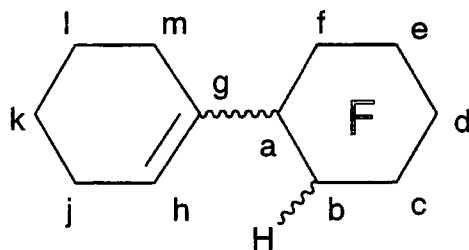

Chemical Shift (ppm)	Multiplicity	Coupling Constants	Relative Intensity	Assignment
¹H				
1.60-1.79	m		8	k,l
2.11-2.22	m		8	j,m
4.86-5.24	m		2	b
6.12	s		1	h
6.36	s		1	h
¹³C				
21.02	s			l
21.03	s			l
22.03	s			k
22.11	s			k
23.78	t	$^3J_{CF} = 2.3$		m
24.56	t	$^3J_{CF} = 4.5$		m
25.15	s			j
25.28	s			j
84.75	m			a,b
105.78-111.52	m			c,d,e,f
124.98	d	$^2J_{CF} = 19.9$		g
126.90	d	$^2J_{CF} = 20.2$		g
132.83	m			h
¹⁹F				
-116.12 to -144.92	m			c,d,e,f
-174.10	m		1	a (<i>trans</i>)
-187.03	m		1	a (<i>cis</i>)
-205.84	m		1	b (<i>trans</i>)
-229.58	m		1	b (<i>cis</i>)

NMR Spectrum 43: 1,x-Di-(1,1,2,3,3,3-hexafluoropropyl)-cyclopentadiene (x = 3,4) (148).

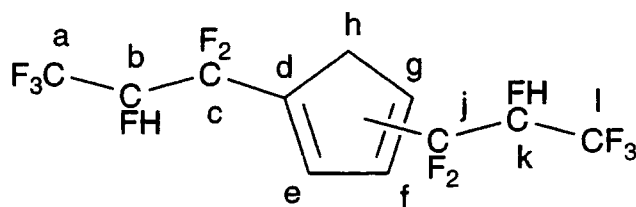

Chemical Shift (ppm)	Multiplicity	Coupling Constants	Relative Intensity	Assignment
¹H				
2.05-2.46	m			h
2.90	m			e,f,g
5.13	m			b,k
¹³C				
28.66	s			h
28.87	s			h
82.31	m			b,k
88.61	s			e or f or g
90.10	s			e or f or g
96.45	m			d, f or g
114.71	m			c,j
120.40	q d	¹ J _{CF} = 283 ² J _{CF} = 25.9		a,k
¹⁹F				
-73.56	m		3	a
-117.59 and -126.78	AB	J _{AB} = 287	1	b or k
-120.02 and -126.44	AB	J _{AB} = 286	1	b or k
-210.25	m		1	c,j

NMR Spectrum 44: 1-(1,1,2,3,3,3-Hexafluoropropyl)-1,2-dibromocyclohexane (149).

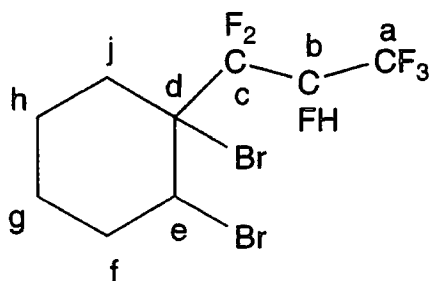

Chemical Shift (ppm)	Multiplicity	Coupling Constants	Relative Intensity	Assignment
¹H				
1.62-2.78	m		8	f,g,h,j
4.65	s		1	e
5.72	d d q	$^2J_{HF} = 43.6$ $^3J_{HF1} = 19.6$ $^3J_{HF} = 6.0$	1	b
¹³C				
19.19	s			g
20.87	s			h
21.45	s			j
26.40	s			f
32.36	s			e
48.93	d	$^2J_{CF} = 6.0$		d
84.87	d d q	$^1J_{CF} = 199$ $^2J_{CF1} = 61.4$ $^2J_{CF} = 34.3$		b
116.07	d d d	$^1J_{CF1} = 269$ $^1J_{CF2} = 251$ $^2J_{CF} = 24.0$		c
120.70	q d	$^1J_{CF} = 283$ $^2J_{CF} = 26.4$		a
¹⁹F				
-73.74	m		3	a
-73.87	m		3	a
-107.19 and -111.54	AB	$J_{AB} = 274$	4	c
-206.41	d m	$^2J_{FH} = 48.9$	1	b
-206.94	br d	$^2J_{FH} = 43.6$	1	b

NMR Spectrum 45: 1-(1,1,2,3,3,3-Hexafluoropropyl)-1,2-dibromocyclopentane (150).

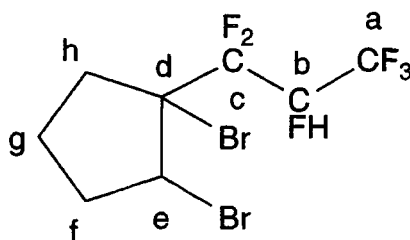

Chemical Shift (ppm)	Multiplicity	Coupling Constants	Relative Intensity	Assignment
¹H				
2.02-2.19	m		2	g
2.36-2.44	m		2	f
2.73-3.08	m		2	h
4.65	d	$^4J_{HF} = 5.2$		e
4.69	d	$^4J_{HF} = 5.2$		e
5.64	d d q d	$^2J_{HF} = 43.2$ $^3J_{HF1} = 18.0$ $^3J_{HF} = 5.6$ $^3J_{HF2} = 2.0$	1	b
¹³C				
18.43	s			g
20.45	s			g
32.98	d	$^3J_{CF} = 1.9$		h
33.69	m			h
35.96	s			f
37.26	s			f
52.85	dd	$^3J_{CF1} = 6.4$ $^3J_{CF2} = 2.7$		e
53.44	s			e
73.88	t	$^2J_{CF} = 22.4$		d
74.84	t	$^2J_{CF} = 22.8$		d
83.74-88.09	m			b
116.52	d d d	$^1J_{CF1} = 267$ $^1J_{CF2} = 248$ $^2J_{CF} = 26.6$		c
116.87	d d d	$^1J_{CF1} = 263$ $^1J_{CF2} = 257$ $^2J_{CF} = 25.9$		c
120.71	q d d	$^1J_{CF} = 283$ $^2J_{CF} = 25.9$ $^3J_{CF} = 1.5$		a
120.75	q d	$^1J_{CF} = 283$ $^2J_{CF} = 25.9$		a

Continued overleaf.

¹⁹F				
-73.86	m		6	a
-100.11 and	AB	$J_{AB} = 273$	2	c
-112.43				
-111.44	m		2	c
-208.60	d m	${}^2J_{FH} = 43.2$	1	b
-209.00	d m	${}^2J_{FH} = 43.4$	1	b

NMR Spectrum 46: 1-(1,1,2,3,3,3-Hexafluoropropyl)-5-bromocyclopentene (**151**).

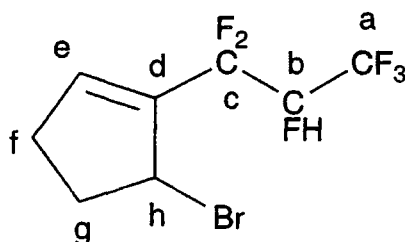

Chemical Shift (ppm)	Multiplicity	Coupling Constants	Relative Intensity	Assignment
¹H				
2.84-3.22	m		4	g
5.06-5.12	m		4	f
5.11	d	$^4J_{\text{HF}} = 6.4$	1	h
5.18	d	$^4J_{\text{HF}} = 3.6$	1	h
5.23	d d q d	$^2J_{\text{HF}} = 43.2$ $^3J_{\text{HF1}} = 18.4$ $^3J_{\text{HF}} = 5.6$ $^3J_{\text{HF2}} = 2.0$	2	b
6.63	s		2	e
¹³C				
45.32	s			g
45.99	d	$^3J_{\text{CF}} = 4.6$		h
46.99	s			f
85.08	d m	$^1J_{\text{CF}} = 197$		b
114.63	d d d	$^1J_{\text{CF1}} = 255$ $^1J_{\text{CF2}} = 246$ $^2J_{\text{CF}} = 25.9$		c
120.48	q d	$^1J_{\text{CF}} = 283$ $^2J_{\text{CF}} = 25.9$		a
138.42	t	$^2J_{\text{CF}} = 26.6$		d
140.99	t	$^3J_{\text{CF}} = 7.6$		e
¹⁹F				
-73.38	m		3	a
-107.28 and -109.54	AB	$J_{\text{AB}} = 278$	2	c
-208.29	d q	$^2J_{\text{FH}} = 43.2$ $^3J_{\text{FF}} = 13.2$	1	b

NMR Spectrum 47: 1-(1,1,2,3,3,3-Hexafluoropropyl)-cyclopentene epoxide (**152**).

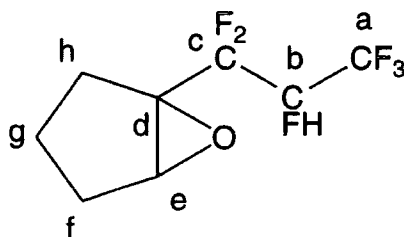

Chemical Shift (ppm)	Multiplicity	Coupling Constants	Relative Intensity	Assignment
¹H				
1.42-2.16	m		12	f,g,h
3.75	s		1	e
3.76	s		1	e
4.92	m		2	b
¹³C				
18.35	s			g
19.17	s			g
24.29	s			h
25.20	m			h
26.28	s			f
26.72	s			f
60.74	m			e
61.60	d	$^3J_{CF} = 6.5$		e
64.69	t	$^2J_{CF} = 33.6$		d
65.56	d d	$^2J_{CF1} = 35.5$ $^2J_{CF2} = 25.9$		d
84.49	m			b
115.38	d d d	$^1J_{CF1} = 262$ $^1J_{CF2} = 250$ $^2J_{CF} = 25.1$		c
115.94	d d d	$^1J_{CF1} = 245$ $^1J_{CF2} = 231$ $^2J_{CF} = 23.2$		c
120.54	q d	$^1J_{CF} = 283$ $^2J_{CF} = 25.5$		a
120.59	q d	$^1J_{CF} = 283$ $^2J_{CF} = 25.5$		a
¹⁹F				
-73.94	m		3	a
-74.15	m		3	a
-111.63 and -118.37	AB	$J_{AB} = 288$	2	c
-114.96 and -121.60	AB	$J_{AB} = 274$	2	c
-210.83	m		2	b

NMR Spectrum 48: 1-(1,1,2,3,3,3-Hexafluoropropyl)-cyclohexene epoxide (**153**).

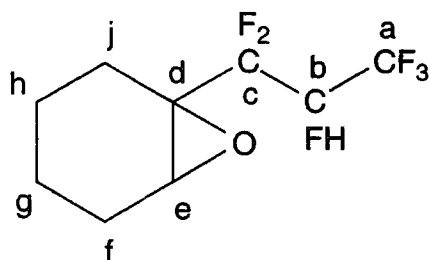

Chemical Shift (ppm)	Multiplicity	Coupling Constants	Relative Intensity	Assignment
¹H				
1.15-1.50	m		4	g,h
1.70-2.05	m		4	f,j
3.37	m		1	e
4.90	m		1	b
¹³C				
18.28	s			g
19.02	s			h
19.11	s			h
21.77	s			j
22.69	t	$^3J_{CF} = 1.9$		j
23.41	s			f
23.51	s			f
54.26	m			e
55.10	d d	$^3J_{CF1} = 9.2$ $^3J_{CF2} = 1.9$		e
57.60	t	$^2J_{CF} = 29.6$		d
58.04	d d	$^2J_{CF1} = 30.2$ $^2J_{CF2} = 24.4$		d
84.66	m			b
115.57	d d d	$^1J_{CF1} = 256$ $^1J_{CF2} = 251$ $^2J_{CF} = 24.8$		c
116.13	t d	$^1J_{CF1} = 252$ $^2J_{CF} = 22.1$		c
120.43	q d	$^1J_{CF} = 282$ $^2J_{CF} = 25.5$		a
¹⁹F				
-74.17	m		3	a
-74.38	m		3	a
-118.10 and -121.80	AB	$J_{AB} = 281$	2	c
-120.92 and -123.70	AB	$J_{AB} = 271$	2	c
-210.56	d q	$^2J_{FH} = 44.4$ $^3J_{FF} = 10.9$	1	b
-211.02	d q	$^2J_{FH} = 44.4$ $^3J_{FF} = 10.9$	1	b

NMR Spectrum 49: 1-(1,1,2,3,3,3-Hexafluoropropyl)-cyclohexane-1,2-diol (**154**).

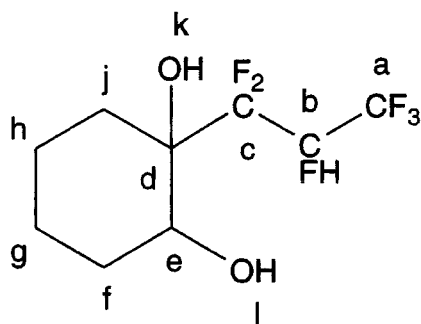

Chemical Shift (ppm)	Multiplicity	Coupling Constants	Relative Intensity	Assignment
¹H				
1.41-2.22	m			f,g,h,j,k,l
3.91	s			e
3.93	s			e
5.28	d d q d	$^2J_{HF} = 43.2$ $^3J_{HF1} = 19.2$ $^3J_{HF} = 6.0$		b
5.44	d d m	$^3J_{HF2} = 1.6$ $^2J_{HF} = 43.2$ $^3J_{HF} = 19.6$		b
¹³C				
18.37	s			h
19.04	s			h
19.60	s			g
19.67	s			g
24.84	s			f
26.11	s			f
28.63	s			j
29.02	s			j
67.54	s			e
69.20	s			e
74.91	t	$^2J_{CF} = 22.4$		d
83.45	d m	$^1J_{CF} = 197$		b
118.82	m			c
120.87	q d	$^1J_{CF} = 282$ $^2J_{CF} = 25.1$		a
¹⁹F				
-73.80	m			a
-119.26 and -121.70	AB	$J_{AB} = 275$		c
-124.53	m			c
-208.89	m			b

NMR Spectrum 50: 1-(1,1,2,3,3,3-Hexafluoropropyl)-3,5-dibromo-cyclohexene (155).

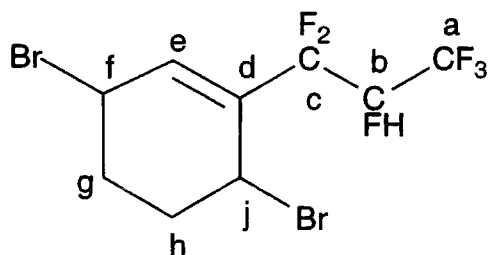

Chemical Shift (ppm)	Multiplicity	Coupling Constants	Relative Intensity	Assignment
¹H				
1.40-2.65	m		4	g,h
4.76	s		1	f or j
4.97	s		1	f or j
5.08	m		1	b
6.49	s			e
6.51	s			e
¹³C				
21.75	s			g or h
23.42	s			g or h
26.71	s			g or h
27.73	s			g or h
40.99	t	³ J _{CF} = 3.8		j
42.87	s			f
43.00	t	³ J _{CF} = 4.2		j
48.60	s			f
85.35	d m	¹ J _{CF} = 196		b
115.28	d d d	¹ J _{CF1} = 259 ¹ J _{CF2} = 248 ² J _{CF} = 25.1		c
120.58	q d	¹ J _{CF} = 283 ² J _{CF} = 26.3		a
127.11	t	² J _{CF} = 24.3		d
131.46	t	² J _{CF} = 23.3		d
134.84	t	³ J _{CF} = 7.9		e
135.34	t d	³ J _{CF} = 6.4 ⁴ J _{CF} = 2.7		e
¹⁹F				
-73.40	m			a
-73.80	m			a
-110.28 and -113.58	AB	J _{AB} = 267		c
-208.26	d q	³ J _{HF} = 41.4 ⁴ J _{FF} = 13.9		b
-208.59	d q	³ J _{HF} = 41.8 ⁴ J _{FF} = 11.3		b

NMR Spectrum 51: (1,1,2,3,3,3-Hexafluoropropyl)-benzene (156).

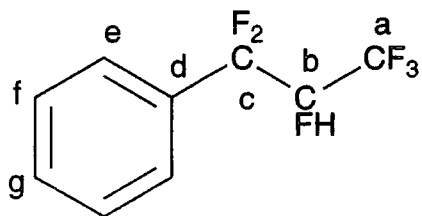

	Chemical Shift (ppm)	Multiplicity	Coupling Constants	Relative Intensity	Assignment
¹H	4.86	d m	$^2J_{HF} = 43.6$	1	b
	7.43	m		5	e, f, g
¹³C	86.97	d m	$^1J_{CF} = 199$		b
	117.15	m			c
	117.74	q m	$^1J_{CF} = 249$		a
	125.81	t		$^3J_{CF} = 6.1$	
	128.67	s			f or g
	130.10	s		f or g	
131.31	t	$^2J_{CF} = 30.1$		d	
¹⁹F	-73.86		m	$J_{AB} = 282$	3
	-104.14 and -109.97	AB	2		c
	-208.88	d m	$^2J_{HF} = 43.6$	1	b

NMR Spectrum 52: 2-Bromo-(1,1,2,3,3,3-hexafluoropropyl)-benzene (**157**).

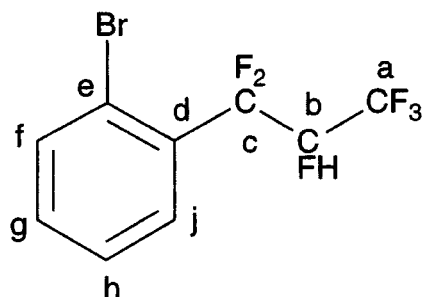

	Chemical Shift (ppm)	Multiplicity	Coupling Constants	Relative Intensity	Assignment
¹H	4.94	d m	$^2J_{HF} = 43.5$	1	b
	7.37	t	$^3J_{HH} = 8.0$	1	g
	7.48	d	$^3J_{HH} = 8.0$	1	f
	7.69	m		2	h,j
¹³C	86.78	d d m	$^1J_{CF} = 198$ $^2J_{CF} = 37.6$		b
	115.86	d d d	$^1J_{CF1} = 279$ $^1J_{CF2} = 263$ $^2J_{CF} = 22.4$		c
	120.62	q d	$^1J_{CF} = 279$ $^2J_{CF} = 26.4$		a
	122.76	s			g
	124.58	t	$^3J_{CF} = 8.2$		j
	129.07	t	$^3J_{CF} = 7.2$		e
	130.29	s			h
	133.46	t	$^2J_{CF} = 25.4$		d
	134.55	s			f
	¹⁹F	-78.06	m		3
-107.62 and -114.63		AB	$J_{AB} = 275$	2	c
-212.92		m		1	b

NMR Spectrum 53: 1-(1,2,3,3,3-Pentafluoro-Z-prop-1-enyl)-cyclopentene (**159**).

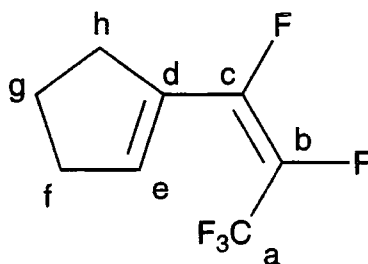

Chemical Shift (ppm)	Multiplicity	Coupling Constants	Relative Intensity	Assignment
¹H				
2.01	pent	$^3J_{HH} = 7.6$	2	g
2.49-2.57	m		4	f,h
6.30	d	$^4J_{HF} = 2.0$	1	e
¹³C				
23.45	s			g
32.36	s			f
33.23	s			h
119.71	q d d	$^1J_{CF} = 270$ $^2J_{CF} = 34.7$ $^3J_{CF} = 9.1$		a
129.42	d	$^2J_{CF} = 22.0$		d
135.42	d d q	$^1J_{CF} = 255$ $^2J_{CF} = 40.8$ $^2J_{CF} = 26.4$		b
140.24	s			e
148.98	d d	$^1J_{CF} = 255$ $^2J_{CF} = 14.9$		c
¹⁹F				
-64.11	m		3	a
-120.37	m		1	c
-155.28	m		1	b

NMR Spectrum 54: 1-(1,2,3,3,3-Pentafluoro-Z-prop-1-enyl)-cyclohexene (**160**).

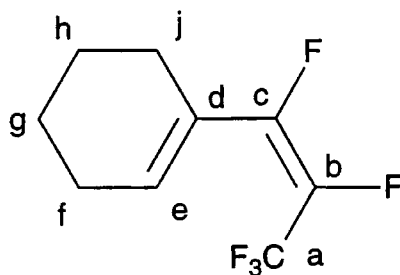

Chemical Shift (ppm)	Multiplicity	Coupling Constants	Relative Intensity	Assignment
¹H				
1.62-1.72	m		4	g,h
2.16	m		4	f,j
6.14	d	$^4J_{HF} = 3.6$	1	e
¹³C				
21.11	s			g
21.70	s			h
25.06	s			j
25.37	s			f
119.68	q d d	$^1J_{CF} = 270$ $^2J_{CF} = 35.5$ $^3J_{CF} = 8.3$		a
125.27	d	$^2J_{CF} = 21.3$		d
134.75	d d	$^1J_{CF} = 280$ $^2J_{CF} = 40.0$		b
137.17	m			e
152.90	d m	$^1J_{CF} = 262$		c
¹⁹F				
-65.49	d d	$^3J_{FF} = 3.4$ $^4J_{FF} = 2.3$	3	a
-117.05	m		1	c
-157.61	pent	$^3J_{FF} = 3.4$	1	b

NMR Spectrum 55: 1-(Perfluorocyclopent-1-enyl)-cyclopentene (161).

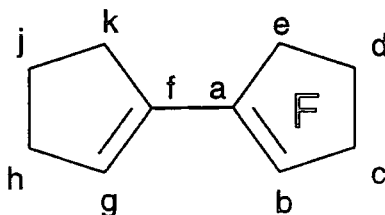

Chemical Shift (ppm)	Multiplicity	Coupling Constants	Relative Intensity	Assignment
¹H				
1.99	pent	$^3J_{HH} = 8.0$	2	j
2.54	m		2	h
2.71	m		2	k
6.56	m		1	g
¹³C				
22.46	s			j
32.81	d	$^4J_{CF} = 3.1$		k
33.28	s			h
106.32-116.28	m			c,d,e
119.81	m			b
127.52	m			a
136.01	m			f
140.85	d	$^4J_{CF} = 6.0$		g
¹⁹F				
-109.28	d	$^4J_{FF} = 10.2$	2	d
-117.72	d	$^3J_{FF} = 15.8$	2	c
-129.93	s		2	e
-133.22	m		1	b

NMR Spectrum 56: 1-(Perfluorocyclopent-2-enyl)-cyclopentene

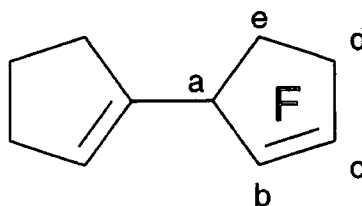

Chemical Shift (ppm)	Multiplicity	Coupling Constants	Relative Intensity	Assignment
¹⁹F				
-112.67 and -119.66	AB	$J_{AB} = 248$	2	d or e
-122.31 and -126.52	AB	$J_{AB} = 238$	2	d or e
-139.95	m		1	b or c
-154.57	m		1	b or c
-156.41	d m	${}^3J_{FF} = 21.8$	1	a

NMR Spectrum 57: 1-(2,3,3,3-Tetrafluoro-1-methoxy-prop-1-enyl)-cyclopentene (163).

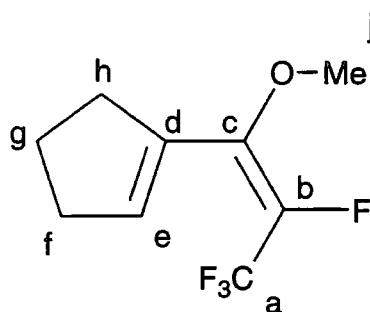

Chemical Shift (ppm)	Multiplicity	Coupling Constants	Relative Intensity	Assignment
¹H				
1.99	pent d	$^3J_{HH} = 7.6$ $^4J_{HH} = 3.6$	2	g
2.46	m		4	f,h
3.85	m		3	j
6.02	s		1	e
¹³C				
23.57	s			g
33.18	s			f or h
34.72	s			f or h
57.01	d	$^4J_{CF} = 2.6$		j
120.55	q d	$^1J_{CF} = 270$ $^2J_{CF} = 36.7$		a
131.46	s			d
133.87	d q	$^1J_{CF} = 248$ $^2J_{CF} = 38.5$		b
136.78	d	$^2J_{CF} = 6.4$		c
139.02	m			e
¹⁹F				
-63.95	m		3	a
-156.58	m		1	b

NMR Spectrum 58: 1-(2,3,3,3-Tetrafluoro-1-propoxy-prop-1-enyl)-cyclopentene (164).

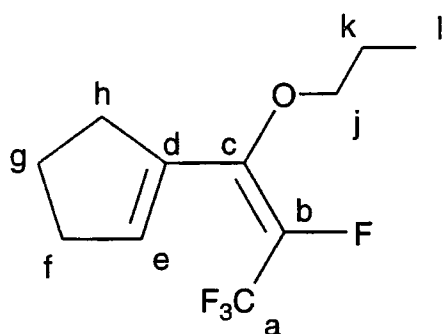

Chemical Shift (ppm)	Multiplicity	Coupling Constants	Relative Intensity	Assignment
¹H				
0.96	t	$^3J_{HH} = 7.6$	3	l
1.66	sext	$^3J_{HH} = 7.2$	2	k
1.97	pent	$^3J_{HH} = 7.6$	2	g
2.45	t	$^3J_{HH} = 7.6$	4	f,h
3.77	t	$^3J_{HH} = 6.4$	2	j
5.92	s		1	e
¹³C				
10.04	s			l
22.96	s			g or k
23.38	s			g or k
33.00	s			f or h
34.42	s			f or h
71.27	s			j
120.49	q d	$^1J_{CF} = 270$ $^2J_{CF} = 37.0$		a
131.93	s			d
134.08	d q	$^1J_{CF} = 248$ $^2J_{CF} = 38.1$		b
138.24	m			e
150.16	d	$^2J_{CF} = 7.5$		c
¹⁹F				
-63.80	d	$^3J_{FF} = 12.8$	3	a
-155.89	q	$^3J_{FF} = 12.8$	1	b

NMR Spectrum 59: 1-(2,3,3,3-Tetrafluoro-1-phenylmethoxy-prop-1-enyl)-cyclopentene (**165**).

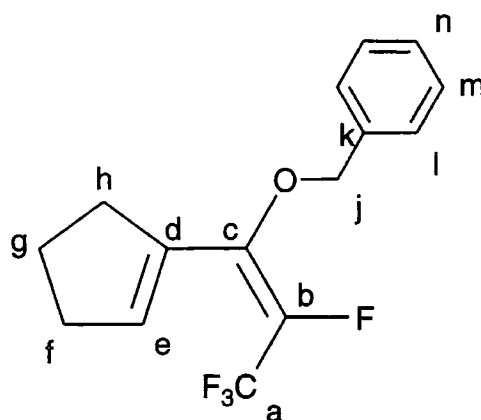

	Chemical Shift (ppm)	Multiplicity	Coupling Constants	Relative Intensity	Assignment
¹H	1.99	pent	$^3J_{HH} = 7.2$	2	g
	2.46	t	$^3J_{HH} = 7.2$	4	f,h
	4.89	s		2	j
	5.98	s		1	e
	7.35	m		5	l,m,n
¹³C	23.51	s			g
	33.19	s			f or h
	34.56	s			f or h
	71.40	s			j
	120.46	q d	$^1J_{CF} = 270$ $^2J_{CF} = 36.7$		a
	127.52	s			m
	128.21	s			n
	128.51	s			l
	131.72	s			d
	134.70	d q	$^1J_{CF} = 249$ $^2J_{CF} = 38.1$		b
	136.55	s			k
	139.17	m			e
150.35	d	$^2J_{CF} = 8.0$		c	
¹⁹F	-63.92	d	$^3J_{FF} = 14.3$	3	a
	-153.74	m		1	b

NMR Spectrum 60: 1-(1,2,3,3,3-Pentafluoro-Z-prop-1-enyl)-cyclohexene epoxide (166).

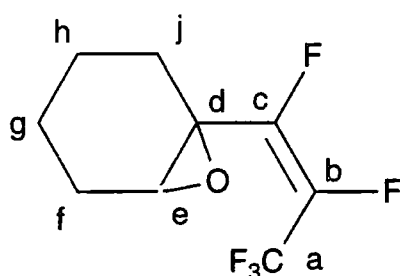

Chemical Shift (ppm)	Multiplicity	Coupling Constants	Relative Intensity	Assignment
¹H				
1.32	m		2	g,h
1.47	m		2	g,h
1.93	m		3	f,j
2.19	m		1	f or j
3.32	s		1	e
¹³C				
18.22	s			g or h
18.90	s			g or h
23.47	s			f or j
26.77	s			f or j
54.02	d	$^2J_{CF} = 25.5$		d
58.83	s			e
119.02	q d d	$^1J_{CF} = 271$ $^2J_{CF} = 34.7$ $^3J_{CF} = 8.4$		a
135.44	d d m	$^1J_{CF} = 258$ $^2J_{CF} = 41.6$		c
152.20	d m	$^1J_{CF} = 265$		b
¹⁹F				
-66.62	d d	$^3J_{FF} = 11.3$ $^4J_{FF} = 7.1$	3	a
-129.21	pent	$^3J_{FF} = 7.9$	1	c
-157.86	m		1	b

NMR Spectrum 61: 1-(1,2,3,3,3-Pentafluoro-Z-prop-1-enyl)-cyclohexene epoxide (167).

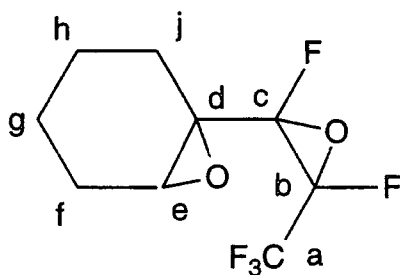

Chemical Shift (ppm)	Multiplicity	Coupling Constants	Relative Intensity	Assignment
¹⁹F				
-75.42	s		3	a
-76.03	s		3	a
-140.88	d	$^3J_{FF} = 31.6$	1	c
-144.59	d	$^3J_{FF} = 29.7$	1	c
-155.51	d	$^3J_{FF} = 31.6$	1	b
-157.99	d	$^3J_{FF} = 30.1$	1	b

Appendix B: Mass Spectra.

Appendix B.i.: Mass Spectra for Chapter 2.

Mass Spectrum 1: 1-(1,1,2,3,3,3-Hexafluoropropyl)-cyclohexanol (**46**).

Mass Spectrum 2: 1-(1,1,2,3,3,3-Hexafluoropropyl)-cyclobutanol (**52**).

Mass Spectrum 3: 1-(1,1,2,3,3,3-Hexafluoropropyl)-cyclopentanol (**54**).

Mass Spectrum 4: 1-(1,1,2,3,3,3-Hexafluoropropyl)-cycloheptanol (**56**).

Mass Spectrum 5: 1-(1,1,2,3,3,3-Hexafluoropropyl)-cyclooctanol (**61**).

Mass Spectrum 6: 1,x-Di-(1,1,2,3,3,3-hexafluoropropyl)-cyclooctanol (**62**).

Mass Spectrum 7: 1-(1,1,2,3,3,3-Hexafluoropropyl)-cyclodecanol (**64**).

Mass Spectrum 8: 1,x-Di-(1,1,2,3,3,3-hexafluoropropyl)-cyclodecanol.

Mass Spectrum 9: 1-(1,1,2,3,3,3-Hexafluoropropyl)-cyclododecanol (**66**).

Mass Spectrum 10: 1,x-Di-(1,1,2,3,3,3-hexafluoropropyl)-cyclododecanol.

Mass Spectrum 1: 1-(1,1,2,3,3,3-Hexafluoropropyl)-cyclohexanol (46).

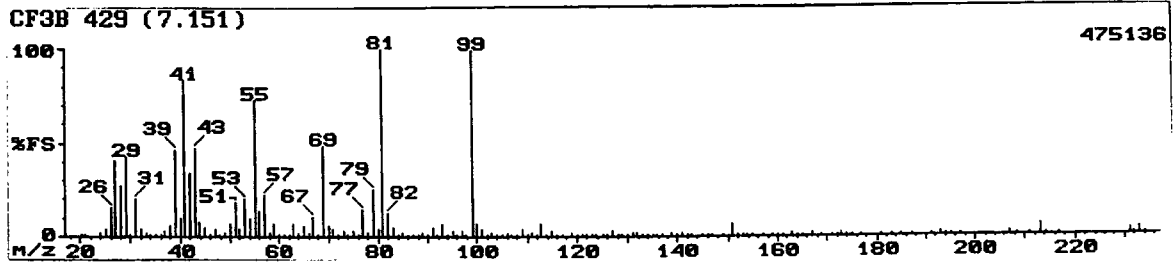

Mass	Rel Int	Mass	Rel Int	Mass	Rel Int	Mass	Rel Int
20	1.31	63	6.57	104	0.57	149	0.48
21	0.07	64	2.37	105	0.63	151	6.36
24	1.75	65	6.20	106	1.95	152	0.27
25	3.50	66	2.33	107	1.16	153	0.63
26	15.95	67	10.51	108	0.81	154	0.17
27	40.73	68	1.27	109	4.09	155	1.08
28	27.16	69	48.28	110	1.08	157	0.22
29	42.24	70	5.82	111	1.51	159	0.83
30	1.24	71	4.26	112	0.51	160	0.15
31	20.69	72	0.63	113	6.47	161	0.21
32	3.50	73	2.64	114	0.75	163	1.87
33	1.90	74	1.19	115	2.49	164	0.17
34	0.18	75	3.10	116	0.21	165	0.25
35	0.11	76	0.59	117	0.47	167	2.13
36	0.29	77	14.87	119	2.02	169	0.31
37	3.18	78	2.41	120	0.45	171	1.33
38	5.39	79	25.65	121	1.25	172	0.28
39	46.77	80	3.83	122	0.24	173	1.59
40	9.97	81	100.00	123	1.44	174	0.51
41	83.62	82	12.98	124	0.17	175	0.13
42	34.27	83	4.58	125	0.36	177	0.17
43	47.41	84	1.16	126	0.27	181	0.17
44	7.76	85	1.89	127	2.69	183	0.41
45	4.74	86	0.35	128	0.32	185	0.14
46	0.67	87	0.78	129	1.37	187	0.51
47	4.20	88	0.78	130	0.22	191	1.31
48	0.70	89	1.78	131	1.87	193	2.40
49	1.59	90	1.12	132	1.91	194	0.68
50	6.41	91	4.53	133	1.43	195	0.25
51	18.53	92	0.28	134	0.21	197	0.12
52	3.42	93	6.57	135	0.47	207	1.52
53	20.47	94	0.89	136	0.20	208	0.11
54	10.18	95	3.13	137	0.28	211	0.72
55	73.28	96	1.19	139	1.60	213	6.25
56	13.31	97	3.35	140	0.25	214	0.41
57	22.20	98	1.13	141	1.80	217	0.21
58	1.62	99	99.14	142	0.19	231	3.06
59	6.36	100	6.84	143	1.05	232	0.52
60	0.58	101	3.93	145	1.06	233	3.88
61	1.44	102	0.90	146	0.25	234	0.31
62	1.25	103	2.42	147	0.49		

Mass Spectrum 2: 1-(1,1,2,3,3,3-Hexafluoropropyl)-cyclobutanol (52).

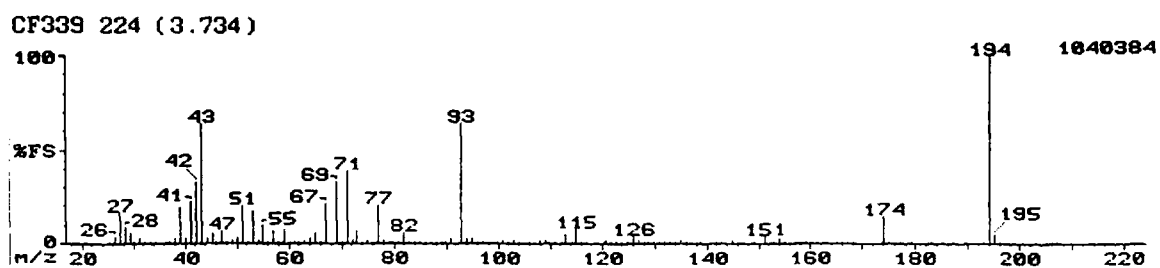

Mass	Rel Int	Mass	Rel Int	Mass	Rel Int	Mass	Rel Int
20	0.04	63	2.26	103	1.57	143	0.22
25	0.12	64	2.78	104	0.82	145	1.54
26	3.72	65	5.86	105	0.47	146	0.62
27	16.54	66	0.47	106	0.72	147	0.06
28	8.66	67	21.56	107	0.71	149	0.06
29	5.81	69	33.07	108	1.48	151	3.76
30	0.13	70	1.03	109	2.21	152	0.13
31	3.05	71	38.98	110	0.19	153	0.20
32	0.65	72	1.87	111	0.24	154	3.22
33	0.86	73	7.19	112	0.48	155	0.93
34	0.03	74	0.47	113	4.58	156	0.07
36	0.03	75	2.29	114	0.73	157	0.18
37	0.74	76	0.55	115	7.68	159	0.92
38	2.56	77	20.57	116	0.62	160	0.08
39	19.00	78	1.62	117	0.17	161	0.07
40	2.93	79	0.24	119	0.60	163	0.20
41	22.15	80	0.55	120	0.08	165	0.76
42	32.68	81	0.50	121	1.70	166	0.06
43	63.78	82	5.54	122	0.12	167	0.53
44	3.35	83	0.97	123	0.58	168	0.04
45	6.10	84	0.36	124	0.98	174	14.76
46	0.82	85	0.47	125	0.22	175	0.86
47	6.89	86	0.13	126	4.33	176	0.07
48	0.27	87	0.17	127	1.92	177	0.04
49	1.94	88	0.65	128	0.31	179	0.04
50	3.15	89	0.73	129	0.77	183	0.09
51	20.57	90	0.19	130	0.04	185	0.18
52	1.35	91	3.35	131	0.73	187	0.17
53	17.72	93	63.78	132	1.14	194	100.00
54	1.72	94	2.51	133	0.51	195	4.90
55	9.25	95	2.53	134	0.22	196	0.33
56	1.27	96	0.62	135	2.14	203	0.17
57	6.99	97	0.39	136	0.16	205	0.62
58	1.28	98	0.09	137	0.50	206	0.05
59	7.28	99	0.26	138	0.04	207	0.26
60	0.76	100	0.36	139	0.81	221	0.06
61	2.09	101	2.17	141	1.29		
62	0.73	102	0.27	142	0.07		

Mass Spectrum 3: 1-(1,1,2,3,3,3-Hexafluoropropyl)-cyclopentanol (54).

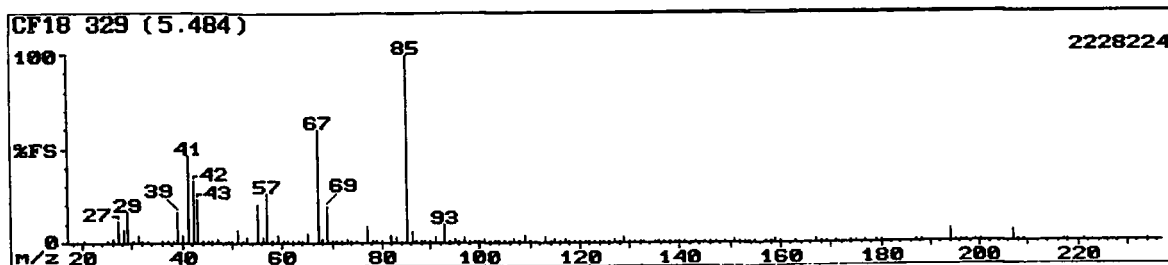

Mass	Rel Int	Mass	Rel Int	Mass	Rel Int	Mass	Rel Int
20	0.06	65	4.73	107	2.27	149	0.91
25	0.05	67	60.29	108	0.28	151	2.32
26	1.63	68	2.26	109	3.86	152	0.06
27	11.95	69	19.67	110	0.35	153	0.21
28	6.99	70	0.60	111	0.23	154	0.20
29	16.91	71	1.05	113	2.69	155	0.58
30	0.45	72	0.18	114	0.28	157	0.92
31	3.86	73	1.73	115	2.05	158	0.05
32	0.42	74	0.12	116	0.22	159	2.16
33	0.55	75	1.37	117	2.00	160	0.33
36	0.05	77	8.78	118	0.12	163	0.03
37	0.29	78	0.60	119	0.99	167	1.95
38	1.09	79	0.48	120	0.08	168	0.12
39	16.73	80	0.22	121	0.65	169	0.10
40	4.09	82	3.95	122	0.05	171	0.04
41	46.32	83	2.86	123	0.35	174	0.75
42	33.09	85	100.00	124	0.10	175	0.17
43	22.98	86	5.51	125	0.09	177	0.22
44	1.15	87	1.24	126	0.37	179	0.51
45	1.42	88	0.57	127	1.95	180	0.04
46	0.21	89	1.08	128	0.14	187	1.11
47	1.67	90	0.36	129	2.71	188	0.08
49	0.67	91	2.88	130	0.15	194	7.03
50	0.85	93	9.56	131	0.58	195	0.97
51	6.48	94	0.48	132	0.35	196	0.07
52	0.62	95	2.01	133	0.41	197	0.05
53	3.26	96	0.46	135	0.46	199	0.72
55	20.77	97	2.64	136	0.03	200	0.05
56	2.44	98	0.47	137	0.48	207	5.74
57	26.65	99	0.37	138	0.04	208	0.75
58	1.30	100	0.26	139	1.32	209	0.05
59	4.18	101	1.83	140	0.10	217	0.24
60	0.34	102	0.14	141	0.70	218	0.14
61	0.44	103	0.94	143	0.03	221	0.07
62	0.30	104	0.14	145	0.22	234	0.02
63	1.37	105	0.37	146	0.04		
64	0.74	106	0.52	147	0.21		

Mass Spectrum 4: 1-(1,1,2,3,3,3-Hexafluoropropyl)-cycloheptanol (56).

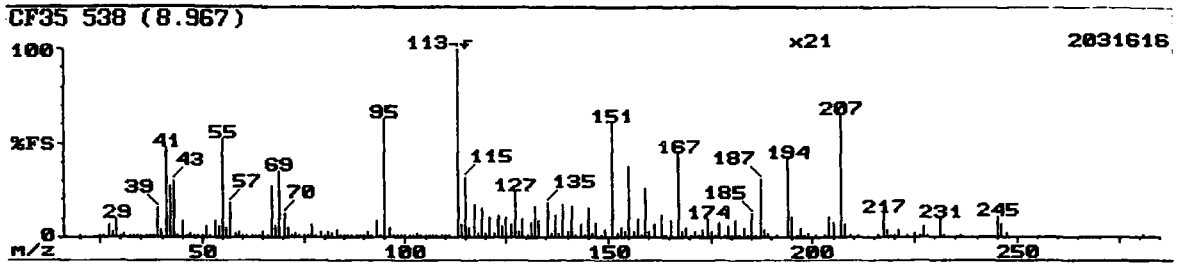

Mass	Rel Int	Mass	Rel Int	Mass	Rel Int	Mass	Rel Int
20	0.02	73	1.79	123	0.55	176	0.02
25	0.03	74	0.15	124	0.30	177	0.40
26	0.57	75	0.91	125	0.54	178	0.03
27	7.11	76	0.16	126	0.31	179	0.30
28	3.28	77	6.70	127	1.18	180	0.02
29	10.13	78	0.69	128	0.15	181	0.42
30	0.29	79	2.92	129	0.47	182	0.03
31	2.09	80	1.12	130	0.03	183	0.23
32	0.20	81	3.18	131	0.38	184	0.02
33	0.27	82	2.18	132	0.80	185	0.62
34	0.06	83	3.68	133	0.43	186	0.05
35	0.01	84	1.00	135	0.89	187	1.52
36	0.03	85	1.40	136	0.10	188	0.19
37	0.12	86	0.20	137	0.55	189	0.11
38	0.58	87	0.35	138	0.07	191	0.07
39	15.93	88	0.27	139	0.87	194	2.03
40	3.48	89	0.64	140	0.12	195	0.53
41	47.78	90	0.26	141	0.78	196	0.03
42	27.42	91	3.28	142	0.07	197	0.22
43	30.24	92	0.24	143	0.33	198	0.04
44	1.40	93	8.87	144	0.05	199	0.09
45	8.32	94	0.89	145	0.74	201	0.02
46	0.38	95	62.90	146	0.09	203	0.04
47	2.03	96	4.84	147	0.39	204	0.50
48	0.32	97	1.37	148	0.04	205	0.37
49	0.54	98	0.21	149	0.19	207	3.15
50	0.70	99	0.56	151	2.97	208	0.34
51	6.05	100	0.20	152	0.09	209	0.04
52	0.96	101	1.39	153	0.25	211	0.05
53	8.77	102	0.16	154	0.15	216	0.04
54	5.49	103	1.74	155	1.81	217	0.62
55	52.42	104	0.24	156	0.12	218	0.18
56	5.19	105	0.45	157	0.48	219	0.01
57	18.35	106	0.50	158	0.05	220	0.04
58	1.71	107	0.67	159	1.26	221	0.20
59	2.60	108	0.26	160	0.16	223	0.04
60	0.24	109	1.16	161	0.32	225	0.08
61	0.84	110	0.15	163	0.57	226	0.03
62	0.20	111	0.39	164	0.05	227	0.30
63	0.84	113	100.00	165	0.44	228	0.03
64	0.52	114	7.16	167	2.17	231	0.46
65	3.28	115	1.56	168	0.13	232	0.04
66	0.86	116	0.25	169	0.22	236	0.04
67	26.81	117	0.83	170	0.02	245	0.51
68	6.00	118	0.09	171	0.13	246	0.32
69	34.88	119	0.74	172	0.04	247	0.09
70	13.10	120	0.10	173	0.18	281	0.02
71	4.64	121	0.52	174	0.48		
72	0.42	122	0.10	175	0.15		

Mass Spectrum 5: 1-(1,1,2,3,3,3-Hexafluoropropyl)-cyclooctanol (61).

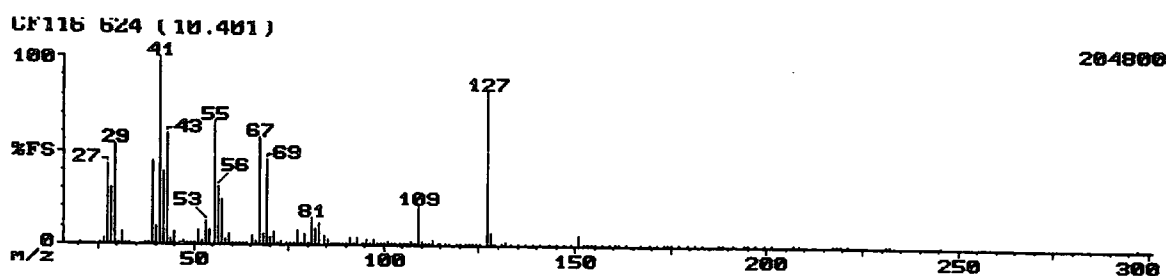

Mass	Rel Int	Mass	Rel Int	Mass	Rel Int	Mass	Rel Int
20	0.08	65	4.78	103	1.08	153	0.22
25	0.12	66	1.54	104	0.26	154	0.14
26	3.31	67	57.00	105	0.41	155	0.46
27	43.00	68	5.59	106	0.52	157	0.25
28	30.25	69	45.50	107	1.72	159	0.98
29	53.00	70	3.72	108	0.41	160	0.13
30	1.37	71	6.56	109	21.75	161	0.31
31	7.00	72	0.73	110	1.99	163	0.11
32	1.18	73	2.00	111	0.71	167	0.94
33	0.84	74	0.17	112	0.17	169	0.21
37	0.29	75	1.14	113	3.09	171	0.18
38	1.30	76	0.33	114	0.21	173	0.25
39	45.00	77	7.81	115	0.77	174	0.18
40	9.88	78	1.05	116	0.20	175	0.17
41	100.00	79	5.66	117	1.02	177	0.44
42	38.50	80	1.24	119	0.89	179	0.42
43	59.00	81	14.25	120	0.17	181	0.09
44	2.88	82	9.00	121	0.26	183	0.14
45	6.47	83	11.25	122	0.06	187	0.30
46	0.47	84	5.16	123	0.25	188	0.10
47	2.31	85	2.81	124	0.08	191	0.14
48	0.32	86	0.32	125	0.16	194	1.12
49	0.90	87	0.45	127	83.00	195	0.42
50	1.08	88	0.32	128	6.84	197	0.30
51	8.13	89	0.81	129	1.09	199	0.34
52	1.63	90	0.41	131	0.93	201	0.13
53	12.25	91	3.41	132	2.03	207	1.28
54	8.25	92	0.31	133	0.64	208	0.22
55	66.00	93	4.28	135	0.28	217	0.51
56	31.50	94	0.84	137	0.23	218	1.05
57	24.75	95	2.44	139	0.84	219	0.22
58	2.88	96	0.55	141	0.73	221	0.91
59	6.00	97	2.81	143	0.18	231	0.50
60	0.25	98	0.86	145	0.27	232	0.48
61	0.77	99	0.75	147	0.21	245	0.17
62	0.29	100	0.37	149	0.43	297	0.03
63	1.23	101	1.80	151	5.66		
64	0.84	102	0.12	152	0.21		

Mass Spectrum 6: 1,x-Di-(1,1,2,3,3,3-hexafluoropropyl)-cyclooctanol (62).

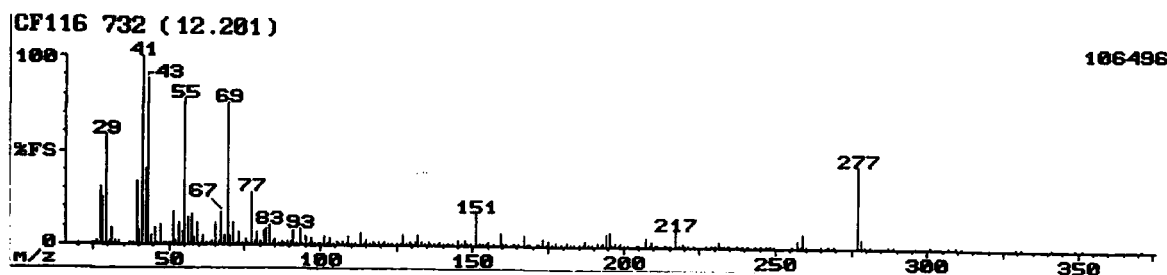

Mass	Rel Int	Mass	Rel Int	Mass	Rel Int	Mass	Rel Int
20	0.25	81	7.57	137	0.53	204	0.62
25	0.18	82	8.29	138	0.37	205	1.01
26	2.28	83	10.22	139	2.18	207	4.75
27	30.77	84	2.18	140	0.60	208	0.26
28	24.76	85	2.79	141	1.31	209	3.05
29	58.17	86	0.59	142	0.32	210	0.25
30	1.50	87	1.95	143	0.50	211	0.83
31	8.35	88	0.66	145	3.26	213	0.96
32	2.19	89	2.42	146	0.44	214	0.35
33	2.15	90	1.92	147	2.48	215	0.63
37	0.31	91	8.11	148	0.37	217	9.07
38	0.94	92	0.73	149	1.25	218	0.92
39	33.89	93	9.13	151	17.55	219	1.89
40	7.69	94	1.17	152	0.53	220	0.35
41	100.00	95	5.11	153	1.14	221	1.17
42	40.63	96	1.16	154	0.38	223	0.36
43	88.46	97	4.21	155	2.37	227	1.43
44	4.75	98	1.14	157	0.95	229	0.77
45	8.89	99	1.29	159	6.73	230	0.30
46	0.85	100	0.68	160	0.64	231	2.49
47	11.00	101	4.63	161	1.22	232	1.20
48	0.72	102	0.42	163	0.47	233	0.65
49	1.35	103	4.33	164	0.29	234	0.47
50	1.19	104	0.94	165	0.83	235	0.91
51	17.31	105	1.53	167	5.89	237	0.50
52	1.59	106	0.92	168	0.51	239	1.10
53	11.24	107	2.06	169	1.29	241	0.43
54	6.43	108	1.37	171	0.55	243	0.27
55	77.88	109	4.87	172	0.57	245	0.48
56	14.36	110	0.76	173	3.41	247	0.74
57	16.11	111	1.44	174	1.17	248	0.44
58	4.03	113	6.49	175	2.91	249	0.61
59	11.30	114	0.88	176	0.13	255	0.30
60	0.99	115	3.03	177	1.64	257	3.76
61	5.05	116	0.66	179	0.65	258	0.41
62	0.55	117	1.61	181	2.30	259	7.33
63	1.44	118	0.33	182	0.33	260	0.91
64	1.92	119	1.46	183	0.48	265	0.24
65	11.48	120	0.37	185	0.90	267	0.30
66	2.19	121	2.31	186	0.34	269	0.50
67	17.07	122	0.44	187	3.28	277	43.51
68	5.23	123	1.43	188	0.44	278	4.93
69	75.96	125	0.57	189	1.02	279	0.57
70	4.87	126	0.65	191	1.91	281	0.28
71	12.08	127	6.19	192	0.35	287	0.21
72	1.38	128	0.44	193	1.73	289	0.67
73	6.85	129	1.77	194	6.43	301	0.35
74	0.56	130	0.25	195	8.11	307	0.31
75	2.55	131	1.79	196	0.78	309	0.33
76	0.71	132	5.47	197	1.92	311	0.24
77	28.61	133	2.28	198	0.27	329	0.48
78	2.19	134	0.32	199	1.56	331	0.31
79	7.21	135	1.76	200	0.26	341	0.22
80	1.80	136	0.26	201	0.54	349	0.60
351	0.23	371	0.38				

Mass Spectrum 7: 1-(1,1,2,3,3,3-Hexafluoropropyl)-cyclodecanol (64).

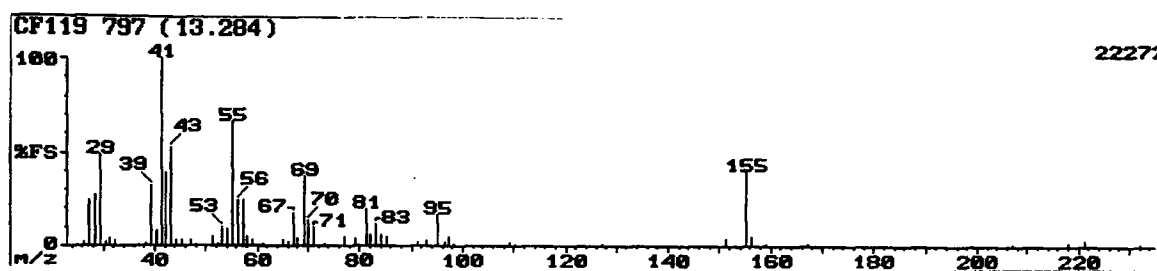

Mass	Rel Int	Mass	Rel Int	Mass	Rel Int	Mass	Rel Int
26	2.03	47	2.46	69	36.78	97	4.67
27	23.85	51	4.58	70	13.86	98	1.15
28	27.30	52	1.40	71	9.41	109	2.10
29	48.85	53	9.63	73	1.22	110	0.94
30	1.56	54	8.76	77	4.44	127	1.24
31	3.79	55	66.38	79	3.59	151	3.81
32	3.11	56	24.43	81	19.25	155	39.37
38	0.96	57	23.85	82	5.75	156	4.60
39	32.18	58	4.54	83	11.21	159	1.29
40	8.12	59	3.16	84	5.60	167	1.02
41	100.00	61	0.69	85	4.38	207	1.28
42	39.08	65	3.30	91	2.14	218	1.54
43	52.30	66	1.51	93	2.51	221	2.91
44	3.14	67	17.10	95	16.02	232	1.33
45	3.05	68	3.61	96	1.54		

Mass Spectrum 8: 1,x-Di-(1,1,2,3,3,3-hexafluoropropyl)-cyclodecanol.

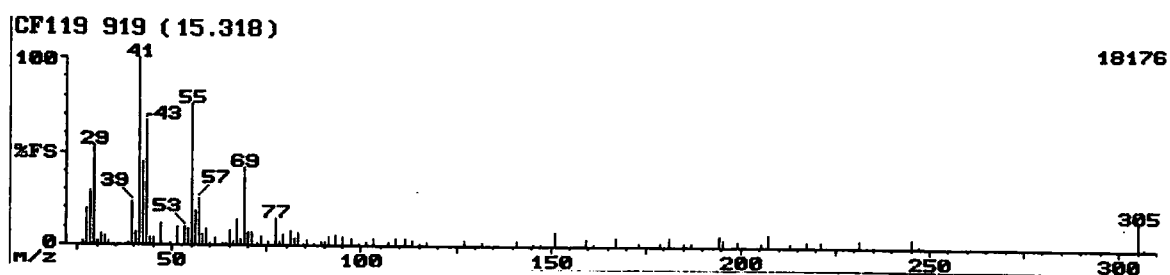

Mass	Rel Int	Mass	Rel Int	Mass	Rel Int	Mass	Rel Int
26	1.76	57	25.35	84	1.05	151	8.01
27	19.19	58	5.90	85	3.06	159	4.09
28	29.58	59	8.89	87	1.43	161	1.21
29	53.52	60	1.25	89	1.85	167	4.60
30	1.50	61	4.01	90	1.67	173	2.40
31	5.57	63	0.87	91	5.19	179	1.98
32	4.67	64	1.36	93	5.63	181	4.84
33	1.91	65	7.83	95	5.17	185	1.65
38	0.98	66	1.85	97	3.81	187	1.56
39	23.59	67	13.38	99	1.30	194	5.37
40	6.95	68	3.10	101	2.40	195	3.98
41	100.00	69	41.55	103	3.63	199	2.86
42	45.07	70	6.69	107	1.56	205	1.85
43	67.25	71	6.87	109	3.52	207	6.60
44	3.94	72	1.41	111	4.18	213	1.56
45	3.85	73	4.82	113	3.21	217	2.66
47	11.18	75	2.11	115	1.40	221	2.64
49	1.12	77	14.17	117	1.50	231	4.05
51	9.86	78	1.61	127	2.93	245	5.02
53	9.60	79	5.72	132	2.33	247	1.38
54	8.27	81	7.57	141	2.93	305	14.70
55	75.70	82	3.59	145	0.80	306	1.30
56	18.22	83	6.43	147	1.16		

Mass Spectrum 9: 1-(1,1,2,3,3,3-Hexafluoropropyl)-cyclododecanol (66).

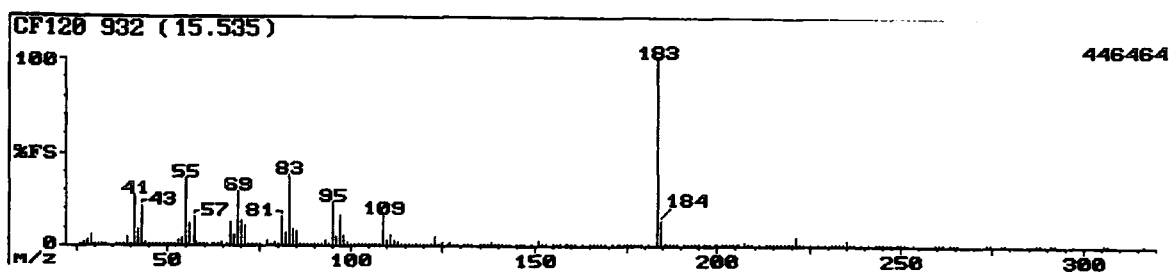

Mass	Rel Int	Mass	Rel Int	Mass	Rel Int	Mass	Rel Int
26	0.08	83	38.07	139	0.95	203	0.10
27	1.52	84	9.00	140	1.26	204	0.23
28	3.27	85	8.14	141	1.35	205	0.55
29	5.62	86	0.66	142	0.10	206	0.06
30	0.18	87	0.49	143	0.21	207	1.66
31	0.58	88	0.12	145	0.53	208	0.25
32	1.03	89	0.35	146	0.07	209	0.20
33	0.07	90	0.14	147	0.34	211	0.29
36	0.05	91	1.36	149	0.24	213	0.32
37	0.05	92	0.16	151	2.47	214	0.05
38	0.10	93	2.71	152	0.14	215	0.09
39	4.76	94	0.52	153	0.35	216	0.18
40	1.22	95	23.39	155	0.93	217	1.16
41	27.06	96	5.33	156	0.10	218	1.33
42	8.60	97	16.97	157	0.24	219	0.39
43	21.10	98	5.50	158	0.04	220	0.51
44	1.82	99	2.42	159	1.36	221	4.70
45	0.86	100	0.27	160	0.15	222	0.40
46	0.09	101	0.76	161	0.35	223	0.27
47	0.75	102	0.08	163	0.32	225	0.16
48	0.13	103	0.85	165	1.29	227	0.17
49	0.15	104	0.17	166	0.21	229	0.09
50	0.12	105	0.30	167	1.39	231	1.18
51	0.96	106	0.30	168	0.14	232	1.43
52	0.22	107	0.85	169	0.16	233	0.38
53	2.74	108	0.25	171	0.27	234	0.39
54	3.64	109	16.06	172	0.04	235	2.78
55	35.55	110	2.97	173	0.59	236	0.36
56	12.04	111	5.73	174	0.18	237	0.17
57	15.14	112	2.68	175	0.18	239	0.11
58	1.88	113	2.35	176	0.05	241	0.05
59	1.23	114	0.27	177	0.49	243	0.06
60	0.11	115	0.79	178	0.05	244	0.06
61	0.42	116	0.20	179	0.33	245	0.91
62	0.08	117	1.16	181	0.55	246	0.84
63	0.17	118	0.15	183	100.00	247	0.24
64	0.12	119	0.58	184	13.53	249	0.35
65	1.49	120	0.09	185	1.40	250	0.10
66	0.65	121	0.76	186	0.14	251	0.09
67	12.96	122	0.16	187	0.67	253	0.06
68	6.14	123	4.42	188	0.20	259	0.61
69	29.59	124	1.09	189	0.13	260	0.29
70	13.42	125	2.01	191	0.49	261	0.07
71	10.72	126	0.41	192	0.06	263	0.16
72	0.80	127	1.63	193	0.43	264	0.10
73	1.05	128	0.19	194	0.82	265	0.09
74	0.09	129	0.42	195	0.87	273	0.37
75	0.26	131	0.47	196	0.10	274	0.13
77	2.98	132	0.19	197	0.39	277	0.24
78	0.31	133	0.54	198	0.08	278	0.04
79	2.31	135	0.44	199	0.38	287	0.15
80	0.72	136	0.07	200	0.04	288	0.08
81	15.83	137	0.58	201	0.12	291	0.29
82	7.11	138	1.53	202	0.06	292	0.07
305	0.17	306	0.08	316	0.07		

Mass Spectrum 10: 1,x-Di-(1,1,2,3,3,3-hexafluoropropyl)-cyclododecanol.

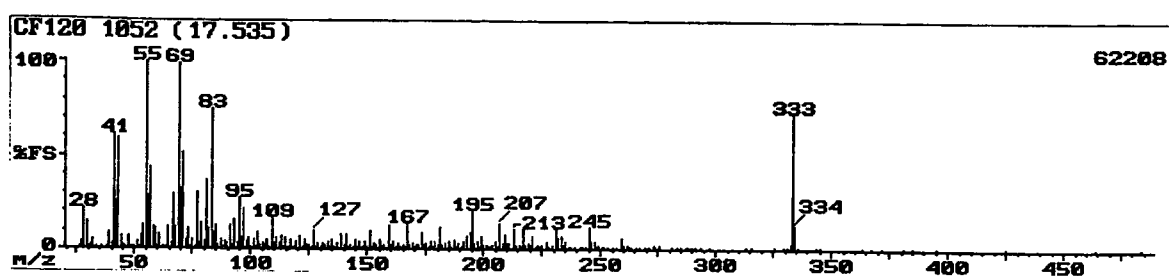

Mass	Rel Int	Mass	Rel Int	Mass	Rel Int	Mass	Rel Int
26	0.28	83	74.49	139	7.82	196	2.75
27	3.73	84	9.05	140	1.72	197	3.45
28	21.60	85	12.14	141	7.61	198	0.62
29	14.92	86	1.67	142	0.98	199	6.89
30	0.53	87	5.32	143	1.53	200	1.55
31	1.62	88	1.02	144	0.20	201	1.72
32	5.04	89	3.65	145	4.89	202	0.31
33	0.32	90	2.57	146	0.87	203	0.80
36	0.36	91	12.45	147	4.30	204	1.47
38	0.35	92	1.56	148	0.80	205	3.96
39	8.74	93	15.12	149	4.09	206	0.68
40	2.91	94	3.11	150	0.50	207	13.79
41	61.32	95	26.75	151	9.36	208	2.67
42	25.31	96	6.28	152	0.51	209	7.92
43	59.67	97	21.50	153	3.29	210	2.47
44	7.20	98	4.19	154	2.16	211	3.19
45	2.06	99	6.22	155	5.09	213	10.39
46	0.35	100	0.95	156	0.48	214	1.80
47	7.00	101	4.58	157	1.90	215	1.62
48	0.59	102	0.41	159	12.86	216	0.29
49	0.52	103	9.05	160	1.70	217	10.70
50	0.44	104	1.88	161	3.78	218	2.03
51	4.35	105	3.32	162	1.14	219	3.09
52	0.62	106	1.72	163	3.16	220	2.01
53	6.51	107	4.42	164	0.50	221	7.20
54	12.55	108	1.17	165	2.19	222	1.14
55	100.00	109	16.46	166	0.68	223	2.13
56	27.98	110	3.32	167	13.58	224	0.24
57	44.03	111	5.71	168	2.26	225	1.88
58	11.42	112	2.52	169	2.73	227	3.88
59	11.11	113	6.69	170	0.26	228	1.36
60	1.03	114	1.23	171	1.59	229	1.47
61	8.13	115	5.92	172	1.59	231	10.70
62	0.86	116	1.36	173	8.74	232	5.40
63	0.83	117	4.55	174	1.88	233	6.38
64	1.04	118	0.70	175	3.11	234	2.13
65	11.83	119	3.42	176	1.04	235	3.45
66	2.57	121	6.79	177	4.01	236	0.48
67	28.81	122	1.35	178	0.54	237	0.89
68	11.42	123	5.20	179	3.94	239	1.22
69	98.77	124	1.70	180	2.37	241	1.10
70	32.10	125	1.83	181	11.52	242	0.51
71	51.44	126	0.43	182	2.42	243	1.26
72	4.50	127	10.08	183	2.88	245	11.83
73	10.70	128	1.25	185	4.01	246	3.70
74	1.19	129	2.80	186	1.11	247	3.60
75	4.40	130	0.73	187	5.14	248	0.75
76	0.77	131	2.44	188	1.21	249	1.90
77	30.04	132	1.98	189	3.09	250	1.10
78	2.57	133	4.19	190	0.96	251	0.63
79	13.58	134	0.79	191	3.70	253	1.11
80	3.65	135	5.02	193	6.46	255	0.96
81	36.63	136	1.02	194	8.95	257	0.61
82	10.80	137	2.67	195	19.96	259	6.25
260	1.63	275	1.49	313	0.89	346	0.29
261	1.62	281	0.27	315	1.06	363	0.39
262	0.42	283	0.40	325	0.73	367	0.30
263	0.30	285	0.59	329	0.22	372	0.40
265	0.42	287	0.42	331	0.53	381	0.28
267	0.34	288	0.50	333	2.85	385	0.43
269	0.18	289	0.43	333	72.43	396	0.34
271	0.53	291	0.30	334	12.24	425	0.44
273	1.77	293	0.60	335	1.38	464	0.30
274	0.81	297	0.19	343	0.53	484	1.45

Appendix B.ii.: Mass Spectra for Chapter 3.

Mass Spectrum 11: 1-(1,1,2,3,3,3-Hexafluoropropyl)-4-methylcyclohexanol (68).

Mass Spectrum 12: 1,4-Di-(1,1,2,3,3,3-hexafluoropropyl)-4-methylcyclohexanol (69).

Mass Spectrum 13: 1-(1,1,2,3,3,3-Hexafluoropropyl)-4-tert-butylcyclohexanol (71).

Mass Spectrum 14: 1-(1,1,2,3,3,3-Hexafluoropropyl)-2-(2,2,3,4,4,4-hexafluorobutyl)-cyclohexanol (73).

Mass Spectrum 15: *Exo*-2-(1,1,2,3,3,3-hexafluoropropyl)-norbornan-2-ol (77).

Mass Spectrum 16: 2,x-Di-(1,1,2,3,3,3-hexafluoropropyl)-norbornan-2-ol (78).

Mass Spectrum 17: 1,x-Di-(1,1,2,3,3,3-hexafluoropropyl)-decahydronaphtan-1-ol (79).

Mass Spectrum 18: 2-(1,1,2,3,3,3-Hexafluoropropyl)-decahydronaphtan-2-ol (81).

Mass Spectrum 19: 2,x-Di-(1,1,2,3,3,3-hexafluoropropyl)-decahydronaphtan-2-ol.

Mass Spectrum 11: 1-(1,1,2,3,3,3-Hexafluoropropyl)-4-methylcyclohexanol (68).

CF379 454 (7.567)

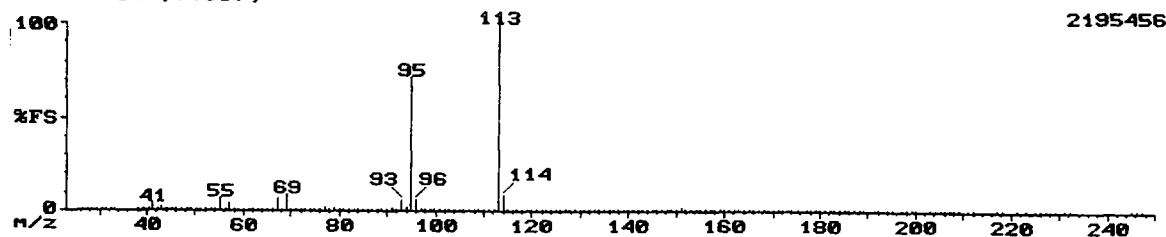

Mass	Rel Int	Mass	Rel Int	Mass	Rel Int	Mass	Rel Int
27	0.16	78	0.34	126	0.18	174	0.10
27	0.85	79	1.64	127	1.06	175	0.03
28	0.65	80	0.75	128	0.16	177	0.30
29	1.20	81	1.25	129	0.43	178	0.03
30	0.05	82	0.97	130	0.13	179	0.29
31	0.19	83	1.35	131	0.25	180	0.03
32	0.04	84	0.36	132	0.37	181	0.24
33	0.04	85	0.65	133	0.29	182	0.02
38	0.08	86	0.09	134	0.05	183	0.16
39	1.27	87	0.19	135	0.36	184	0.01
40	0.33	88	0.14	136	0.07	185	0.75
41	3.45	89	0.38	137	0.34	186	0.07
42	1.22	90	0.18	138	0.06	187	0.58
43	2.43	91	2.13	139	0.49	188	0.16
44	0.11	92	0.27	140	0.11	189	0.06
45	0.25	93	5.78	141	0.77	191	0.17
46	0.03	94	1.49	142	0.09	192	0.02
47	0.19	95	71.64	143	0.26	194	0.27
48	0.03	96	6.20	144	0.09	195	0.07
49	0.06	97	1.17	145	0.62	197	0.17
50	0.11	98	0.20	146	0.07	198	0.02
51	0.70	99	0.43	147	0.39	199	0.09
52	0.16	100	0.13	148	0.04	200	0.01
53	1.31	101	0.86	149	0.10	203	0.05
54	0.48	102	0.13	150	0.04	204	0.06
55	6.34	103	0.74	151	1.78	205	0.33
56	1.04	104	0.13	152	0.07	206	0.04
57	3.92	105	0.28	153	0.18	207	1.07
58	0.26	106	0.31	154	0.06	208	0.40
59	0.48	107	0.59	155	0.72	209	0.05
60	0.05	108	0.20	156	0.07	211	0.14
61	0.25	109	1.01	157	0.34	212	0.02
62	0.05	110	0.27	158	0.05	217	0.28
63	0.18	111	0.33	159	0.94	218	0.03
64	0.13	112	0.97	160	0.13	221	0.02
65	0.86	113	100.00	161	0.23	223	0.01
66	0.27	114	8.35	162	0.02	225	0.12
67	6.81	115	1.27	163	0.31	226	0.02
68	0.93	116	0.21	164	0.04	227	0.44
69	8.30	117	0.36	165	0.35	228	0.05
70	1.42	118	0.06	166	0.04	229	0.01
71	0.87	119	0.48	167	0.97	231	0.84
72	0.13	120	0.07	168	0.08	232	0.08
73	0.60	121	0.37	169	0.14	245	1.28
74	0.07	122	0.08	170	0.02	246	0.13
75	0.29	123	0.37	171	0.13	247	0.05
76	0.08	124	0.29	172	0.02		
77	2.36	125	0.41	173	0.11		

Mass Spectrum 12: 1,4-Di-(1,1,2,3,3,3-hexafluoropropyl)-4-methylcyclohexanol (69).

CF379 651 (10.851)

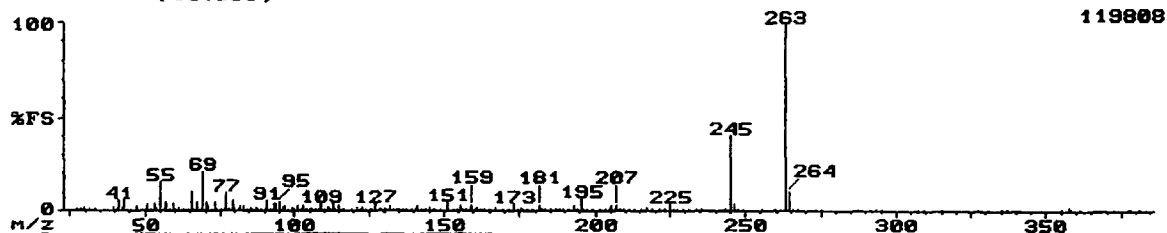

119808

Mass	Rel Int	Mass	Rel Int	Mass	Rel Int	Mass	Rel Int
27	0.87	85	2.00	136	0.10	204	0.27
28	0.61	86	0.24	137	0.15	205	2.80
29	1.71	87	2.06	139	0.91	206	0.34
31	0.55	88	0.47	140	0.25	207	3.31
33	0.18	89	1.32	141	2.92	208	0.32
39	2.00	90	0.66	142	0.51	209	0.51
40	0.62	91	6.14	143	0.58	211	0.42
41	6.25	92	0.77	144	0.38	213	1.22
42	1.84	93	3.69	145	1.84	215	0.18
43	5.93	94	4.27	146	0.22	217	1.78
44	0.34	95	4.43	147	1.26	219	0.30
45	0.84	96	1.80	149	0.30	221	0.13
47	3.25	97	2.84	151	4.86	223	0.46
49	0.36	98	0.62	153	0.85	225	4.33
50	0.31	99	2.18	154	0.21	226	0.51
51	4.11	100	0.47	155	2.44	227	0.27
52	0.56	101	2.70	156	0.26	229	0.34
53	3.95	102	0.44	157	0.31	231	1.15
54	1.07	103	3.14	159	3.29	233	0.19
55	15.38	104	0.82	160	0.31	235	1.40
56	1.31	105	1.18	161	2.19	243	0.73
57	5.07	106	0.55	162	0.21	245	40.81
58	0.56	107	0.88	163	0.45	246	4.27
59	4.11	108	0.35	165	1.35	247	0.41
60	0.31	109	4.01	167	1.90	249	0.12
61	2.00	110	0.67	169	0.28	255	0.26
62	0.22	111	1.58	171	0.53	259	0.19
63	0.63	112	0.58	173	3.58	263	100.00
64	0.63	113	3.53	174	0.52	264	10.36
65	10.74	114	0.61	175	1.83	265	0.71
66	1.06	115	2.51	176	0.21	267	0.10
67	4.81	116	0.45	177	1.23	273	0.35
68	1.23	117	0.82	179	1.11	275	0.57
69	21.37	119	0.99	181	3.10	287	0.37
70	4.65	121	1.55	182	0.30	293	0.35
71	2.46	122	0.42	183	0.23	295	0.58
72	0.42	123	1.55	185	1.24	307	0.27
73	5.13	124	1.39	187	0.88	309	0.36
74	0.29	125	0.58	188	0.68	315	0.33
75	0.97	126	0.26	189	0.13	327	0.18
76	0.14	127	4.27	191	0.49	335	0.66
77	9.78	128	0.52	193	2.92	337	0.55
78	0.99	129	1.26	194	0.58	355	0.25
79	6.14	130	0.16	195	6.41	357	1.47
80	1.01	131	0.72	196	0.70	358	0.19
81	1.12	132	2.78	197	1.08	361	0.23
82	2.43	133	1.14	199	0.84	377	1.12
83	3.14	134	0.10	201	0.35	378	0.16
84	0.71	135	0.88	203	0.55	381	0.43

Mass Spectrum 13: 1-(1,1,2,3,3,3-Hexafluoropropyl)-4-tert-butylcyclohexanol (71).

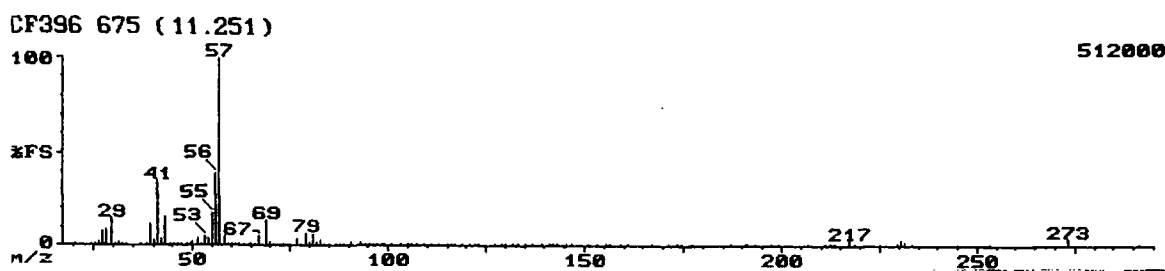

Mass	Rel Int	Mass	Rel Int	Mass	Rel Int	Mass	Rel Int
20	0.15	59	0.74	96	0.36	153	0.08
24	0.15	60	0.10	97	0.86	155	1.33
25	0.43	61	0.32	98	1.15	156	0.15
26	2.06	62	0.25	99	0.89	159	0.13
27	8.05	63	0.75	101	0.73	161	0.09
28	9.15	65	0.96	103	0.29	167	0.16
29	14.80	65	1.40	105	0.19	171	0.09
30	0.45	66	0.84	106	0.10	174	0.22
31	1.59	67	5.30	107	0.31	174	0.09
32	1.21	69	13.80	109	0.77	177	0.12
33	0.12	70	2.04	111	0.63	187	0.15
37	0.48	71	1.18	113	0.48	191	0.22
38	1.44	72	0.17	115	0.40	191	0.18
39	11.25	73	0.49	116	0.09	193	0.26
40	3.20	74	0.15	117	0.10	197	0.29
41	35.40	75	0.44	119	0.16	199	0.14
42	4.25	77	4.35	121	0.88	207	0.27
43	15.20	78	1.13	122	0.20	211	0.24
44	0.71	79	6.90	123	0.19	213	0.32
45	0.57	80	1.56	127	0.68	213	0.26
46	0.15	81	6.30	129	0.28	217	3.30
47	0.35	82	2.08	130	0.16	218	0.13
48	0.08	83	2.91	132	0.72	225	0.11
49	0.19	84	0.50	133	0.15	230	0.90
50	1.55	85	0.61	135	0.10	231	2.50
51	3.60	87	0.20	137	0.52	231	2.23
52	0.99	88	0.18	139	0.15	233	0.20
53	4.70	89	0.33	141	0.35	245	0.39
54	3.40	91	2.09	142	0.09	253	0.20
55	17.00	93	2.34	143	0.11	273	4.25
56	38.40	94	0.16	145	0.16	291	0.27
57	100.00	94	1.16	147	0.24		
58	4.75	95	1.44	151	1.03		

Mass Spectrum 14: 1-(1,1,2,3,3,3-Hexafluoropropyl)-2-(2,2,3,4,4,4-hexafluorobutyl)-cyclohexanol (73).

CF218 606 (10.101)

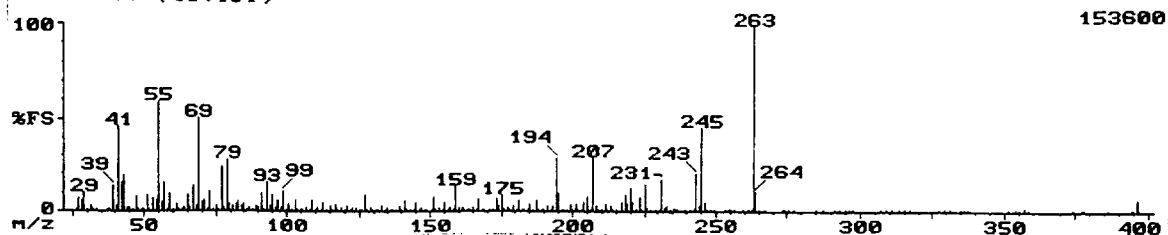

Mass	Rel Int	Mass	Rel Int	Mass	Rel Int	Mass	Rel Int
26	0.42	83	5.54	137	0.84	192	0.96
27	6.58	84	3.08	138	0.11	193	3.21
28	6.08	85	3.58	139	3.33	194	28.67
29	10.17	86	0.73	140	0.72	195	10.00
30	0.34	87	1.67	141	5.54	196	0.98
31	2.60	88	0.73	142	0.58	197	1.07
32	1.40	89	2.79	143	0.64	198	0.70
33	0.78	90	2.33	144	0.14	199	4.08
37	0.13	91	9.88	145	4.46	200	0.63
38	0.43	92	0.98	146	0.76	201	3.46
39	13.67	93	15.83	147	2.02	202	0.43
40	2.88	94	2.48	148	0.33	203	1.02
41	46.00	95	8.88	149	0.95	204	4.88
42	15.17	96	1.70	150	0.18	205	8.00
43	19.00	97	5.71	151	7.75	206	0.55
44	1.86	98	1.55	152	0.58	207	28.83
45	1.64	99	10.54	153	2.27	208	2.49
46	0.81	100	1.35	154	0.89	209	1.38
47	7.83	101	4.13	155	4.38	210	0.17
48	0.30	102	0.92	156	0.49	211	3.46
49	0.99	103	6.08	157	1.94	212	0.46
50	0.74	104	1.26	158	0.30	213	2.48
51	9.17	105	1.14	159	13.50	214	0.43
52	1.00	106	1.24	160	1.79	215	0.54
53	6.33	107	1.78	161	2.29	217	4.46
54	6.04	108	0.94	162	0.21	218	8.58
55	59.33	109	5.54	163	0.79	219	3.88
56	5.21	110	1.04	164	0.12	220	12.67
57	15.17	111	2.28	165	2.32	221	5.00
58	1.31	112	0.50	166	0.16	222	0.47
59	10.04	113	5.00	167	6.71	223	7.42
60	0.89	114	1.00	168	0.63	224	1.05
61	3.79	115	3.21	169	0.55	225	14.17
62	0.41	116	0.67	171	0.98	226	1.63
63	0.86	117	4.17	172	1.16	227	0.55
64	1.86	118	0.49	173	6.58	229	0.84
65	8.71	119	2.23	174	2.88	230	0.21
66	1.65	120	0.39	175	9.21	231	17.33
67	14.00	121	3.08	176	0.67	232	1.81
68	2.71	122	0.74	177	2.21	233	3.17
69	50.00	123	2.27	178	0.20	234	0.65
70	4.42	124	1.96	179	2.49	235	1.49
71	5.38	125	0.38	180	0.86	236	0.26
72	1.34	126	0.43	181	5.83	237	0.19
73	10.33	127	8.29	182	0.70	239	0.09
74	1.32	128	0.63	183	1.02	241	0.41
75	3.04	129	1.84	184	0.09	242	0.20
76	0.74	130	0.50	185	3.88	243	20.33
77	24.00	131	1.33	186	0.41	244	2.83
78	2.25	132	1.30	187	5.71	245	45.33
79	28.33	133	3.33	188	0.76	246	5.17
80	3.71	134	0.52	189	1.29	247	0.84
81	2.75	135	2.13	190	0.21	248	0.15
82	3.71	136	0.54	191	3.04	249	0.54
253	1.29	274	0.17	311	0.31	355	0.49
254	0.20	275	0.93	313	0.20	357	1.66
255	0.54	277	0.20	315	0.60	358	0.29
256	0.17	285	0.27	317	0.48	374	0.09
259	0.14	287	0.60	327	0.56	377	1.41
261	0.23	291	0.21	329	0.11	378	0.23
262	0.95	293	0.51	331	0.18	386	0.18
263	100.00	295	1.15	335	1.14	394	0.24
264	10.67	296	0.19	336	0.13	395	0.28
265	0.95	297	0.18	337	0.74	396	6.54
267	0.68	307	0.55	351	0.22	397	0.86
273	0.79	309	0.29	354	0.45		

Mass Spectrum 15: *Exo-2-(1,1,2,3,3,3-hexafluoropropyl)-norbornan-2-ol (77)*.

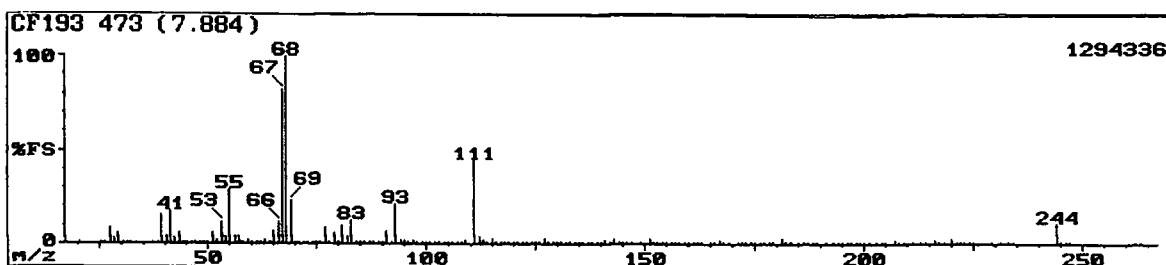

Mass	Rel Int	Mass	Rel Int	Mass	Rel Int	Mass	Rel Int
21	0.01	76	0.17	126	0.12	179	0.50
25	0.04	77	8.54	127	2.75	181	2.73
26	0.68	78	1.17	128	0.36	182	0.20
27	8.78	79	5.54	129	0.39	183	0.25
28	2.67	80	0.84	130	0.07	185	0.81
29	5.46	81	9.41	131	0.52	186	0.09
30	0.15	82	3.50	132	0.57	187	0.61
31	1.07	83	12.97	133	0.81	188	0.06
32	0.20	84	1.11	134	0.13	189	0.07
33	0.26	85	0.74	135	0.48	191	0.03
37	0.19	86	0.14	136	0.07	193	0.09
38	0.85	87	0.16	137	0.22	194	0.19
39	15.59	88	0.24	138	0.03	195	1.24
40	4.05	89	0.52	139	0.80	196	0.08
41	17.41	90	0.18	140	0.16	197	0.31
42	3.28	91	7.12	141	1.50	198	0.05
43	5.54	92	0.85	142	0.29	199	0.09
44	0.75	93	21.84	143	2.51	200	0.03
45	0.76	94	2.18	144	0.31	201	0.28
46	0.13	95	1.90	145	0.77	203	0.97
47	0.94	96	0.61	146	0.08	204	0.07
48	0.09	97	1.72	147	0.31	205	0.72
49	0.32	98	0.21	149	0.11	207	1.50
50	0.97	99	0.73	151	3.32	208	0.18
51	5.70	100	0.22	152	0.12	209	0.18
52	1.50	101	1.19	153	0.33	211	0.04
53	11.39	102	0.20	154	0.10	213	0.07
54	3.94	103	0.81	155	0.94	214	0.07
55	29.11	104	0.17	156	0.11	216	1.58
56	3.56	105	0.30	157	0.93	217	0.19
57	3.72	106	0.37	158	0.08	218	0.04
58	0.48	107	0.37	159	0.96	220	2.49
59	1.64	108	0.14	160	0.12	221	0.92
60	0.19	109	1.56	161	0.74	222	0.07
61	0.27	111	44.30	162	0.06	223	0.76
62	0.32	112	3.42	163	0.24	224	0.06
63	1.48	113	2.14	165	0.84	225	0.19
64	0.61	114	0.47	166	0.07	229	0.21
65	6.49	115	3.13	167	1.62	231	0.04
66	11.71	116	0.33	168	0.12	233	0.24
67	82.28	117	0.37	169	0.06	234	0.05
68	100.00	118	0.09	171	0.09	244	10.84
69	23.73	119	0.70	172	0.04	245	1.31
70	1.20	120	0.12	173	0.38	246	0.08
71	1.08	121	0.40	174	0.06	247	0.13
72	0.20	122	0.28	175	1.09	262	0.48
73	0.88	123	0.88	176	0.08	263	0.03
74	0.14	124	0.30	177	0.69		
75	0.81	125	0.23	178	0.07		

Mass Spectrum 16: 2,x-Di-(1,1,2,3,3,3-hexafluoropropyl)-norbornan-2-ol (78).

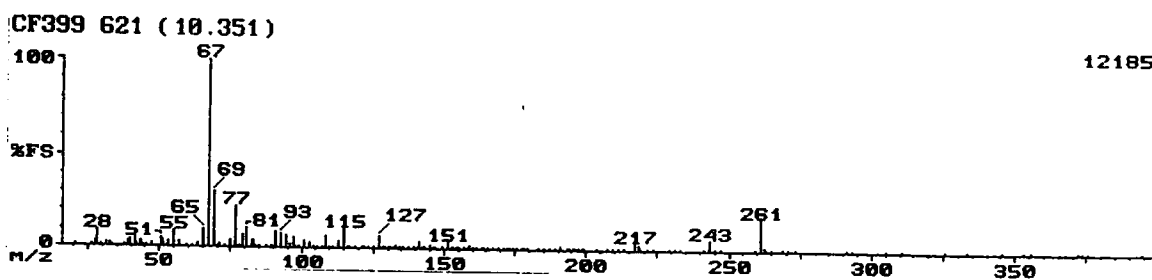

Mass	Rel Int	Mass	Rel Int	Mass	Rel Int	Mass	Rel Int
20	0.71	85	0.92	142	0.75	199	0.97
26	0.55	88	1.09	143	0.35	203	0.24
27	2.70	89	1.04	145	1.65	207	0.71
28	8.40	91	8.82	146	0.40	209	0.41
29	1.29	93	8.14	147	0.63	211	0.97
31	2.23	95	6.36	149	0.11	213	1.31
32	1.62	96	1.67	151	3.62	217	4.36
33	0.25	97	5.78	152	0.40	218	3.16
37	0.33	98	0.69	153	0.87	219	0.22
39	2.84	99	0.61	154	0.30	221	0.59
39	3.83	101	4.20	155	0.63	223	0.73
41	4.57	103	3.11	157	0.71	229	0.37
42	1.10	104	0.45	158	0.47	231	0.56
43	3.05	105	0.55	159	2.09	233	1.08
44	1.30	107	0.91	160	0.25	241	0.97
45	0.39	109	6.88	161	0.22	243	5.62
47	1.67	110	1.16	163	0.33	245	0.14
51	4.73	111	1.17	164	0.25	247	0.28
51	3.47	113	3.57	165	0.38	259	1.33
52	0.58	115	11.13	167	0.87	261	17.65
53	3.05	116	1.30	169	0.21	262	1.63
55	9.03	117	1.34	171	0.50	263	0.29
57	2.81	119	0.88	172	0.23	265	0.53
59	1.37	121	0.95	173	0.84	269	0.54
61	0.41	122	0.66	174	0.23	271	0.42
63	2.35	123	0.80	175	0.35	273	0.74
65	10.03	125	0.34	177	1.17	291	0.88
67	100.00	127	6.36	178	0.52	293	1.10
69	30.04	128	0.85	179	0.58	305	0.36
70	0.95	129	0.42	183	0.53	311	0.24
71	1.62	130	0.29	185	0.30	325	0.21
73	1.12	131	0.85	187	0.29	333	0.23
75	3.73	132	1.05	189	0.10	345	0.23
77	22.69	133	1.55	191	2.06	353	0.54
78	1.04	134	0.40	193	0.87	355	0.22
79	6.57	135	0.53	194	1.01	372	0.36
81	10.45	137	0.30	195	1.13	373	0.21
82	4.04	139	1.05	196	0.71	375	0.30
83	3.57	140	0.59	197	1.40	394	0.43
84	1.44	141	3.41	198	0.85		

Mass Spectrum 17: 1,8-Di-(1,1,2,3,3,3-hexafluoropropyl)-decahydronaphthalen-1-ol
(79).

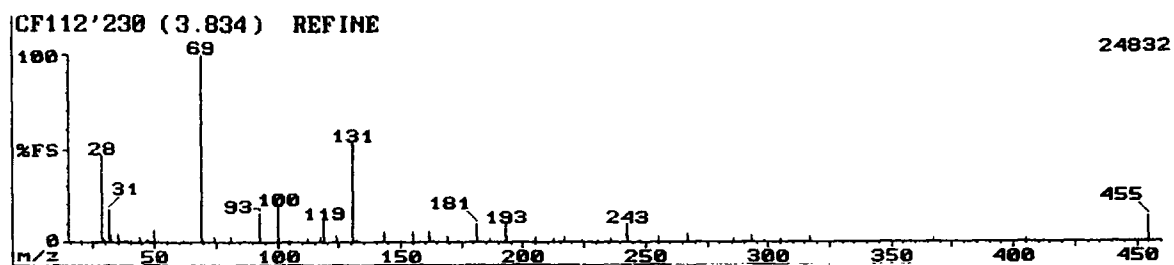

Mass	Rel Int	Mass	Rel Int	Mass	Rel Int	Mass	Rel Int
28	47	93	16	131	53	243	10
31	17	100	20	181	11	455	12
69	100	119	11	193	10		

Mass Spectrum 18: 2-(1,1,2,3,3,3-Hexafluoropropyl)-decahydronaphan-2-ol (81).

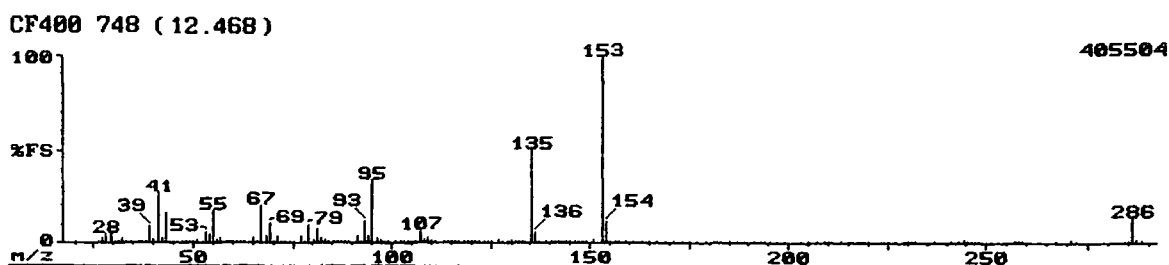

Mass	Rel Int	Mass	Rel Int	Mass	Rel Int	Mass	Rel Int
20	0.05	73	0.43	124	0.18	193	0.19
26	0.15	74	0.07	125	0.12	194	0.12
27	2.92	75	0.19	127	2.07	195	0.26
28	5.18	77	4.10	128	0.58	197	0.43
29	5.18	78	1.15	129	1.23	199	0.50
30	0.15	79	9.97	130	1.82	203	0.26
31	0.65	80	1.74	131	0.46	205	0.56
32	2.43	81	8.21	132	0.53	207	0.56
33	0.12	82	2.62	133	1.15	209	0.83
34	0.06	83	1.94	135	50.00	210	0.10
36	0.08	84	0.28	136	6.12	211	0.30
37	0.07	85	0.49	137	0.57	213	0.07
38	0.22	86	0.08	139	0.34	215	0.06
39	8.96	87	0.18	140	0.20	216	0.08
40	2.07	88	0.08	141	1.37	217	0.65
41	27.02	89	0.27	142	0.40	218	0.09
42	3.03	91	4.17	143	0.48	219	0.27
43	16.10	92	0.96	144	0.09	220	0.11
44	1.39	93	12.06	145	0.48	223	0.92
45	0.62	94	3.58	146	0.16	224	0.13
46	0.20	95	33.59	147	0.24	225	0.41
47	0.85	96	3.08	148	0.31	227	0.11
48	0.31	97	1.69	149	0.20	229	0.86
49	0.12	98	0.30	151	1.89	230	0.60
50	0.35	99	0.36	153	100.00	231	0.39
51	2.40	101	0.47	154	11.30	232	0.09
52	0.83	102	0.16	155	1.15	237	0.09
53	6.06	103	0.64	156	0.17	241	0.16
54	5.18	104	1.06	157	0.20	243	1.15
55	17.17	105	1.10	159	0.63	244	1.53
56	1.80	106	0.50	161	0.17	245	1.40
57	2.87	107	6.69	163	0.15	246	0.16
58	0.40	108	1.70	165	0.36	247	0.50
59	0.98	109	2.75	167	0.67	248	0.08
60	0.12	110	0.65	169	0.13	257	0.81
61	0.19	111	0.42	171	0.17	258	0.76
62	0.18	113	0.67	173	0.19	259	0.12
63	0.41	114	0.16	175	0.16	267	0.18
64	0.22	115	1.09	177	0.46	271	2.05
65	2.56	116	0.25	179	0.34	272	0.28
66	1.18	117	0.44	181	0.30	284	0.10
67	20.71	118	0.14	182	0.08	285	0.43
68	3.52	119	0.65	183	0.27	286	13.95
69	10.42	120	0.16	185	0.32	287	1.96
70	1.12	121	0.73	187	0.18	288	0.15
71	3.61	122	0.26	189	0.24		
72	0.26	123	0.49	191	0.53		

Mass Spectrum 19: 2,x-Di-(1,1,2,3,3,3-hexafluoropropyl)-decahydronaphthan-2-ol.

CF400 837 (13.951)

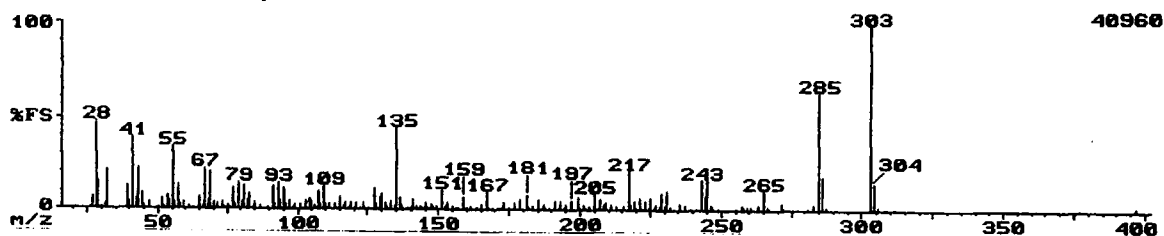

Mass	Rel Int	Mass	Rel Int	Mass	Rel Int	Mass	Rel Int
20	0.58	89	0.97	145	4.26	213	2.28
26	0.54	91	12.34	146	1.08	215	2.00
27	6.60	92	3.01	147	2.66	217	21.72
28	47.50	93	14.37	148	1.63	218	2.70
29	15.47	94	5.31	149	2.28	219	4.73
30	0.62	95	11.25	151	10.47	220	0.94
31	2.97	96	2.70	152	1.48	221	7.07
32	21.25	97	4.80	153	3.67	222	1.20
39	12.34	98	1.43	155	2.27	223	5.31
40	3.63	99	3.20	156	0.60	224	0.90
41	38.44	101	2.85	157	1.35	225	6.84
42	5.55	102	0.81	159	6.88	226	1.27
43	22.34	103	5.08	160	0.80	227	3.20
44	9.02	104	5.47	161	1.92	228	1.65
45	1.85	105	5.04	163	1.23	229	10.16
47	3.48	106	1.89	164	1.10	230	2.00
50	0.75	107	9.96	165	2.89	231	10.31
51	5.35	108	3.09	167	10.16	232	1.84
52	1.27	109	12.97	168	1.13	233	1.04
53	7.38	110	2.47	169	0.91	235	4.02
54	5.23	111	2.47	171	1.40	237	2.50
55	33.91	113	3.05	172	0.93	239	1.03
56	4.18	114	1.07	173	3.55	241	1.39
57	13.75	115	6.76	175	0.87	243	16.88
58	2.62	116	1.71	177	3.75	244	8.16
59	3.95	117	4.10	179	6.21	245	16.88
61	2.06	118	0.87	181	7.85	246	2.62
62	1.08	119	3.40	182	1.31	247	2.05
63	1.05	120	0.84	183	1.67	249	0.54
64	0.78	121	3.40	185	5.86	255	0.88
65	6.95	122	1.31	186	1.04	257	3.05
66	2.41	123	4.14	187	2.47	258	2.27
67	21.88	124	1.37	188	1.16	259	1.62
68	4.69	125	0.87	189	0.66	260	1.95
69	20.00	127	11.25	191	4.53	263	2.89
70	3.91	128	3.20	192	0.43	265	11.09
71	3.09	129	6.88	193	4.92	266	1.82
73	3.91	130	8.44	194	0.58	267	0.77
74	0.55	131	4.06	195	2.50	271	4.34
75	1.49	132	2.40	197	4.45	272	0.70
76	1.36	133	4.92	199	6.52	281	0.70
77	11.56	134	1.80	200	0.75	283	2.54
78	3.16	135	45.00	201	2.62	285	63.75
79	14.69	136	6.56	202	0.61	286	18.44
80	3.55	137	1.62	203	1.46	287	2.32
81	12.19	139	1.30	205	8.63	303	100.00
82	4.53	140	0.65	206	1.26	304	14.84
83	8.28	141	6.17	207	5.39	305	1.62
84	1.04	142	1.60	208	3.13	377	0.74
85	3.55	143	2.36	209	4.26	397	1.48
87	1.55	144	1.04	211	3.05		

Appendix B.iii.: Mass Spectra for Chapter 4.

Mass Spectrum 20: 1,4-Di-(1,1,2,3,3,3-hexafluoropropyl)-cyclohexane-1,4-diol (85).

Mass Spectrum 21: 1-(1,1,2,3,3,3-Hexafluoropropyl)-cyclohexane-1,3-diol (87).

Mass Spectrum 22: 1,3-Di-(1,1,2,3,3,3-hexafluoropropyl)-cyclohexane-1,3-diol (88).

Mass Spectrum 23: 1-(1,1,2,3,3,3-Hexafluoropropyl)-cyclopentane-1,3-diol.

Mass Spectrum 24: 1,3-Di-(1,1,2,3,3,3-hexafluoropropyl)-cyclopentane-1,3-diol (92).

Mass Spectrum 25: 4,6-Dimethyl-1,1,1,2,3,3,7,7,8,9,9,9-dodecafluorononane-4,6-diol (94).

Mass Spectrum 26: 4,7-Dimethyl-1,1,1,2,3,3,8,8,9,10,10,10-dodecafluorodecane-4,7-diol (97).

Mass Spectrum 27: 4-Methyl-1,1,1,2,3,3-hexafluorooctane-4,7-diol (96).

Mass Spectrum 28: 1,1,1,2,3,3,7,7,8,9,9,9-Dodecafluorononane-4,6-diol (100).

Mass Spectrum 29: 1,1,1,2,3,3-Hexafluorohexane-4,6-diol (99).

Mass Spectrum 30: 1,1,1,2,3,3,8,8,9,10,10,10-Dodecafluorodecane-4,7-diol (9).

Mass Spectrum 31: 1,1,1,2,3,3-Hexafluoroheptane-4,7-diol (8).

Mass Spectrum 32: 4-Methyl-1,1,2,3,3-hexafluorohexane-4,6-diol (102a).

Mass Spectrum 33: 1,1,2,3,3-Hexafluoroheptane-4,6-diol (102b).

Mass Spectrum 34: 4-Methyl-1,1,1,2,3,3,7,7,8,9,9,9-dodecafluorononane-4,6-diol (103).

Mass Spectrum 35: 4-Methyl-1,1,2,3,3-hexafluorooctane-4,8-diol (105a).

Mass Spectrum 36: 1,1,2,3,3-Hexafluorononane-4,8-diol (105b).

Mass Spectrum 37: 4-Methyl-1,1,1,2,3,3,9,9,10,11,11,11-dodecafluoroundecane-4,8-diol (103).

Mass Spectrum 38: x-(1,1,1,2,3,3-Hexafluoropropyl)-2-hydroxy-tetrahydrofuran (x=1,4) (Major product) (109).

Mass Spectrum 39: 2-(1,1,1,2,3,3-Hexafluoropropyl)-2-hydroxy-tetrahydrofuran (Lesser product) (109).

Mass Spectrum 40: Tetrahydrofurfuryl-1,1,2,3,3,3-hexafluoropropyl ether (112).

Mass Spectrum 41: 1-(2-Hydro-perfluorocyclopentyl)-cyclopentan-1-ol (114).

Mass Spectrum 42: 1-(2-Hydro-perfluorocyclohexyl)-cyclopentan-1-ol (115).

Mass Spectrum 43: 1-(2-Hydro-perfluorocyclohexyl)-cyclohexan-1-ol (116).

Mass Spectrum 20: 1,4-Di-(1,1,2,3,3,3-hexafluoropropyl)-cyclohexane-1,4-diol (85).

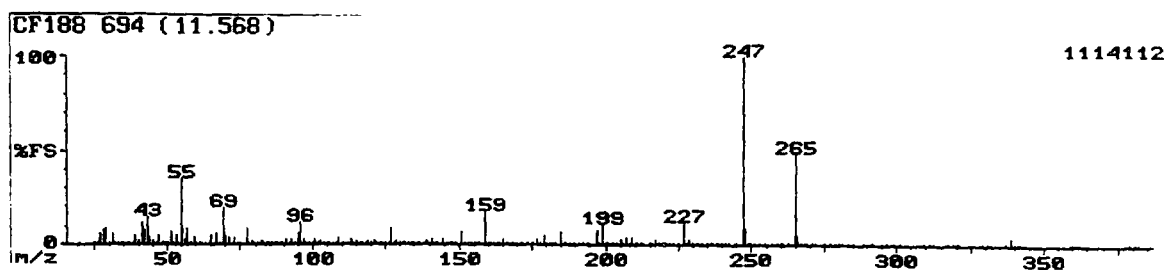

Mass	Rel Int	Mass	Rel Int	Mass	Rel Int	Mass	Rel Int
21	0.07	79	2.05	133	1.37	191	1.03
25	0.02	80	0.45	134	0.13	192	0.12
26	0.48	81	1.36	135	0.99	193	0.13
27	6.25	82	2.39	136	0.10	194	0.48
28	8.00	83	1.70	137	0.33	195	0.38
29	8.73	84	0.57	138	0.09	197	7.44
30	0.25	85	0.92	139	1.49	198	0.49
31	5.74	86	0.19	140	0.51	199	10.20
32	0.80	87	0.37	141	3.22	200	0.90
33	0.37	88	0.33	142	0.26	201	0.24
34	0.03	89	1.25	143	0.50	202	0.06
35	0.04	90	0.41	145	2.48	203	0.28
36	0.21	91	3.01	146	0.84	204	0.12
37	0.07	92	0.26	147	0.56	205	2.67
38	0.34	93	2.48	148	0.09	206	0.15
39	5.15	94	0.47	149	0.45	207	3.68
40	1.47	95	5.88	151	6.71	208	1.17
41	11.31	96	11.86	152	0.31	209	4.11
42	7.35	97	2.71	153	0.95	210	0.51
43	14.61	98	1.37	154	0.37	211	0.59
44	4.07	99	0.63	155	0.84	212	0.06
45	2.23	100	0.30	156	0.05	213	0.06
46	0.26	101	2.69	157	0.68	215	0.17
47	5.12	102	0.27	159	17.00	216	0.02
48	0.55	103	1.52	160	1.32	217	3.33
49	1.44	104	0.31	161	1.06	218	0.27
50	0.49	105	0.42	162	0.07	219	1.08
51	6.71	106	0.54	163	0.48	220	0.23
52	0.64	107	0.99	164	0.09	221	0.22
53	4.94	108	0.21	165	2.92	222	0.05
54	0.89	109	3.72	166	0.29	223	0.08
55	34.56	110	0.64	167	1.32	225	0.24
56	3.01	111	0.51	168	0.19	227	12.04
57	8.92	112	0.45	169	0.41	228	1.24
58	1.21	113	3.17	170	0.12	229	2.96
59	3.93	114	0.46	171	0.74	230	0.34
60	0.71	115	2.41	172	0.09	231	0.67
61	0.30	116	0.37	173	1.12	232	0.10
62	0.19	117	1.13	174	0.28	233	0.11
63	0.76	118	0.11	175	0.22	235	0.52
64	0.81	119	1.70	176	0.08	236	0.07
65	5.19	120	0.13	177	2.67	237	0.10
66	1.36	121	2.32	178	0.22	238	0.06
67	5.84	122	0.27	179	4.53	239	0.13
68	0.56	123	0.48	180	0.41	240	0.08
69	19.12	124	0.10	181	0.32	241	0.28
70	4.66	125	0.43	182	0.10	242	0.04
71	3.79	126	1.25	183	0.64	245	0.28
72	0.57	127	8.27	185	6.99	247	100.00
73	4.04	128	1.36	186	0.55	248	9.19
74	0.37	129	1.79	187	0.98	249	1.11
75	0.64	130	0.38	188	1.24	250	0.09
77	8.73	131	1.26	189	0.73	251	0.14
78	1.09	132	1.29	190	0.63	253	0.06
255	0.05	275	0.11	301	0.03	340	0.44
257	0.21	277	0.57	309	0.27	341	0.68
259	0.95	279	0.83	311	1.12	342	0.10
260	0.19	280	0.10	312	0.13	359	0.59
261	0.19	281	0.13	317	0.08	360	0.06
263	0.03	283	0.02	319	0.55	361	0.37
265	48.53	285	0.05	320	0.08	362	0.06
266	4.43	289	0.17	321	0.18	379	0.12
267	0.51	291	0.87	329	0.05	381	0.19
268	0.04	292	0.11	331	1.09	382	0.03
269	0.17	295	0.04	332	0.12		
271	0.30	297	0.22	337	0.07		
272	0.06	299	0.18	339	3.40		

Mass Spectrum 21: 1-(1,1,2,3,3,3-Hexafluoropropyl)-cyclohexane-1,3-diol (87).

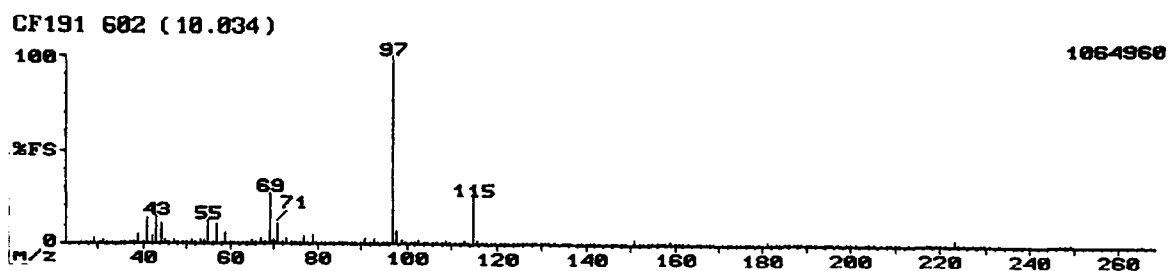

Mass	Rel Int	Mass	Rel Int	Mass	Rel Int	Mass	Rel Int
26	0.09	76	0.18	125	0.20	179	0.33
27	1.33	77	3.53	126	0.23	181	1.78
28	1.17	78	0.39	127	0.94	182	0.16
29	2.60	79	5.31	128	0.27	183	0.49
30	0.12	80	0.69	129	1.11	184	0.06
31	1.83	81	0.56	130	0.21	185	0.27
32	0.28	82	1.17	131	0.60	186	0.75
33	0.13	83	0.70	132	0.36	187	0.34
35	0.02	84	0.21	133	0.27	188	0.05
36	0.11	85	0.50	135	0.79	189	0.81
37	0.07	86	0.24	136	0.11	190	0.09
38	0.15	87	0.15	137	0.13	191	0.43
39	4.52	88	0.16	138	0.07	192	0.05
40	1.22	89	0.58	139	0.70	194	0.54
41	14.04	90	0.33	140	0.05	195	0.47
42	4.25	91	2.88	141	1.45	196	0.03
43	14.33	92	0.18	142	0.14	197	0.18
44	10.38	93	3.13	143	0.17	199	0.47
45	2.36	94	0.30	145	0.55	200	0.11
46	0.18	95	1.45	146	0.12	201	0.03
47	2.04	96	0.40	147	0.44	203	0.08
48	0.10	97	100.00	148	0.05	204	0.17
49	0.34	98	7.21	149	0.20	205	0.17
50	0.34	99	1.71	151	2.69	207	0.49
51	2.28	100	0.25	152	0.13	208	0.05
52	0.28	101	1.12	153	0.32	209	0.42
53	2.38	102	0.18	154	0.15	210	0.06
54	1.50	103	1.50	155	0.78	211	0.18
55	12.98	104	0.15	156	0.10	213	0.03
56	0.82	105	0.20	157	0.23	217	0.03
57	11.06	106	0.21	158	0.11	218	0.06
58	1.23	107	0.59	159	1.48	219	0.19
59	5.84	108	0.38	160	0.18	220	0.18
60	0.61	109	1.71	161	0.60	221	0.05
61	0.22	110	0.14	162	0.05	223	2.45
62	0.19	111	0.72	163	0.14	224	0.16
63	0.35	112	0.15	165	0.35	225	0.04
64	0.29	113	1.53	166	0.08	227	0.04
65	1.54	114	0.14	167	0.72	229	0.07
66	0.34	115	25.00	168	0.06	230	0.06
67	3.15	116	1.73	169	0.16	231	0.40
68	0.53	117	0.93	171	0.25	233	0.05
69	27.31	118	0.11	172	0.14	247	0.49
70	1.88	119	0.54	173	0.39	248	0.11
71	10.38	120	0.05	174	0.28	249	0.04
72	0.61	121	0.58	175	0.96	265	0.06
73	2.43	122	0.11	176	0.09		
74	0.26	123	0.15	177	0.19		
75	0.50	124	0.04	178	0.02		

Mass Spectrum 22: 1,3-Di-(1,1,2,3,3,3-hexafluoropropyl)-cyclohexane-1,3-diol (88).

CF191 663 (11.051)

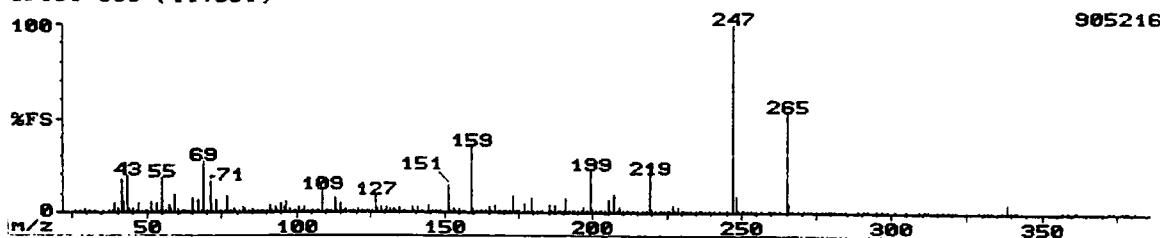

Mass	Rel Int	Mass	Rel Int	Mass	Rel Int	Mass	Rel Int
26	0.07	82	2.83	136	0.27	196	0.10
27	1.05	83	1.50	137	0.48	197	2.46
28	0.69	84	0.54	139	2.57	198	0.18
29	1.47	85	2.18	140	0.59	199	21.95
30	0.06	86	0.54	141	2.52	200	1.81
31	1.03	87	0.29	142	0.20	201	0.42
32	0.23	88	0.39	143	0.54	202	0.16
33	0.21	89	1.37	145	3.68	203	0.47
35	0.07	90	0.50	146	0.73	204	1.13
37	0.17	91	3.99	147	0.51	205	6.65
38	0.19	92	0.23	148	0.13	206	0.33
39	4.81	93	3.14	149	0.59	207	9.62
40	1.69	94	0.72	151	15.05	208	0.86
41	17.42	95	5.09	152	0.55	209	2.80
42	5.94	96	2.80	153	2.40	210	0.49
43	19.12	97	6.31	154	0.25	211	0.49
44	1.60	98	1.87	155	1.95	212	0.08
45	1.98	99	0.68	156	0.22	213	0.18
46	0.25	100	0.32	157	1.12	214	0.03
47	4.41	101	3.11	159	35.29	215	0.18
48	0.24	102	0.45	160	2.26	217	1.04
49	0.93	103	2.94	161	0.73	218	0.18
50	0.39	104	0.59	162	0.09	219	20.36
51	6.11	105	0.49	163	0.62	220	1.68
52	0.46	106	0.57	164	0.10	221	0.81
53	5.20	107	0.66	165	2.80	223	1.33
54	0.38	108	0.37	166	0.16	224	0.11
55	18.78	109	11.20	167	3.45	225	0.20
56	1.17	110	1.10	168	0.28	226	0.11
57	4.02	111	0.74	169	0.40	227	3.42
58	1.95	112	0.21	170	0.06	228	0.28
59	9.84	113	7.58	171	1.15	229	2.69
60	1.67	114	0.77	172	0.14	230	0.32
61	0.34	115	4.75	173	8.37	231	0.73
62	0.21	116	0.52	174	0.78	232	0.11
63	0.83	117	2.23	175	1.07	233	0.14
64	0.69	118	0.37	177	5.06	235	0.40
65	8.03	119	1.19	178	0.35	236	0.03
66	1.14	120	0.26	179	8.14	237	0.14
67	6.90	121	1.68	180	0.73	238	0.12
68	1.07	122	0.26	181	0.57	239	0.26
69	27.60	123	0.58	182	0.15	240	0.15
70	1.29	124	0.09	183	0.66	241	0.38
71	16.40	125	0.51	185	3.99	243	0.05
72	1.00	126	0.69	186	0.30	245	0.36
73	6.36	127	9.16	187	3.42	247	100.00
74	0.36	128	1.48	188	0.40	248	8.60
75	0.97	129	2.60	189	0.71	249	1.02
76	0.29	130	0.39	190	0.18	250	0.07
77	8.82	131	2.43	191	7.58	251	0.28
78	0.95	132	2.21	192	0.49	252	0.05
79	2.01	133	2.12	193	0.22	253	0.09
80	0.43	134	0.19	194	1.02	255	0.08
81	0.83	135	2.74	195	0.91	257	0.26
259	1.05	279	1.33	312	0.13	341	1.15
260	0.23	280	0.16	315	0.08	342	0.13
261	0.23	281	0.13	317	0.07	357	0.05
263	0.14	285	0.18	319	1.16	359	0.60
265	53.39	289	0.15	320	0.13	361	0.64
266	4.61	291	1.28	321	0.35	362	0.08
267	0.57	292	0.14	325	0.04	373	0.64
269	0.09	295	0.06	329	0.06	374	0.05
271	0.45	297	0.43	331	1.13	377	0.04
272	0.05	299	0.23	332	0.13	378	0.05
273	0.04	301	0.06	333	0.19	379	0.07
275	0.20	305	0.13	337	0.06	381	0.16
277	1.14	309	0.11	339	4.44		
278	0.10	311	1.22	340	0.52		

Mass Spectrum 23: 1-(1,1,2,3,3,3-Hexafluoropropyl)-cyclopentane-1,3-diol.

CF39 460 (7.667)

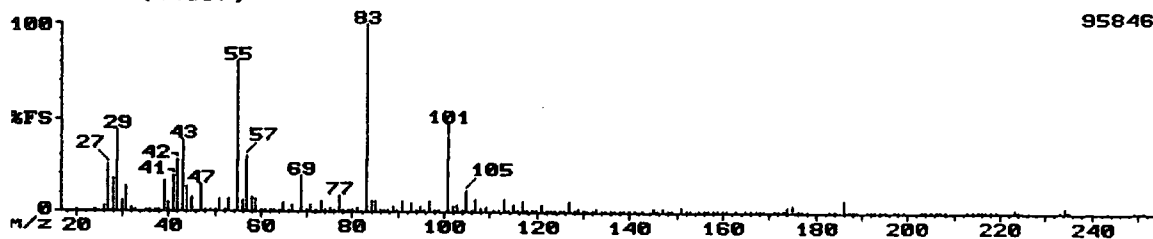

958464

Mass	Rel Int	Mass	Rel Int	Mass	Rel Int	Mass	Rel Int
20	0.12	72	0.39	120	0.12	171	0.74
24	0.02	73	5.40	121	4.27	172	0.58
26	3.02	74	0.23	122	0.91	173	0.21
27	24.89	75	2.00	123	0.46	174	3.26
28	17.09	76	0.56	124	0.05	175	3.66
29	44.02	77	9.19	125	0.67	176	0.58
30	5.37	78	0.39	126	0.26	177	1.01
31	14.00	79	0.43	127	5.98	178	0.10
32	1.54	80	0.35	128	0.38	183	0.42
33	1.06	81	1.68	129	1.64	184	0.03
35	0.04	83	100.00	130	0.10	186	6.84
36	0.34	84	6.09	131	1.36	187	0.58
37	0.25	85	5.37	132	1.03	188	0.09
38	1.32	86	0.48	133	1.46	189	0.24
39	16.45	87	0.81	134	0.08	191	0.77
40	4.97	88	0.77	135	1.44	192	0.06
41	19.76	89	2.70	136	0.48	193	0.08
42	28.21	90	0.28	137	0.36	194	0.75
43	38.89	91	5.58	138	0.56	195	0.72
44	13.78	93	5.10	139	0.83	197	1.07
45	7.59	94	0.73	140	0.36	198	0.09
47	14.21	95	3.10	141	0.57	199	0.08
48	0.24	96	0.39	143	0.10	203	0.07
49	1.32	97	6.17	145	2.14	204	0.07
50	1.26	98	0.52	146	0.26	205	0.24
51	7.05	99	1.28	147	1.98	206	0.24
52	0.87	101	47.86	148	0.15	207	0.15
53	6.33	102	2.51	149	0.16	208	0.06
55	80.77	103	4.01	151	2.64	213	0.08
56	5.90	104	0.65	152	0.73	214	0.89
57	30.34	105	12.07	153	0.59	215	0.17
58	8.01	106	0.61	155	1.12	216	0.06
59	7.05	107	6.94	156	0.37	217	0.54
60	0.91	108	1.92	157	0.43	218	0.04
61	0.40	109	2.70	158	0.69	219	0.13
62	0.28	111	0.58	159	0.67	223	2.24
63	1.16	112	0.43	160	0.29	224	0.14
64	0.74	113	7.26	161	0.08	233	0.49
65	4.59	114	0.65	163	0.15	234	3.23
66	0.76	115	4.35	165	0.35	235	0.26
67	3.85	116	0.36	166	0.77	249	0.07
69	19.44	117	6.30	167	1.40	251	0.09
70	0.57	118	0.28	168	0.13		
71	3.95	119	1.26	169	0.05		

Mass Spectrum 24: 1,3-Di-(1,1,2,3,3,3-hexafluoropropyl)-cyclopentane-1,3-diol (92).

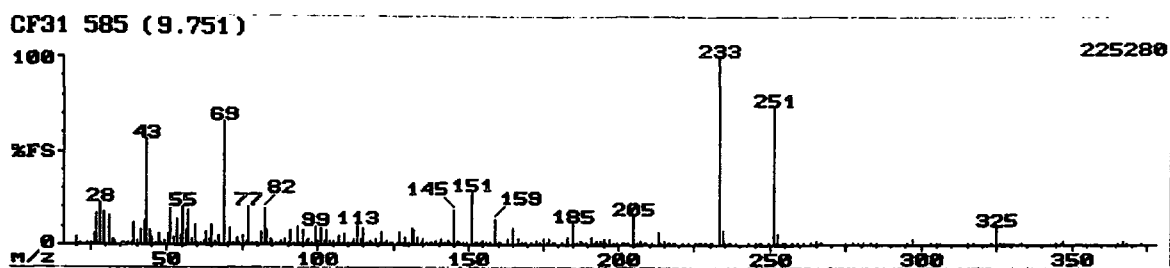

Mass	Rel Int	Mass	Rel Int	Mass	Rel Int	Mass	Rel Int
20	4.26	79	0.78	133	3.98	198	0.21
21	0.10	80	0.87	134	0.36	199	0.13
24	0.68	81	6.76	135	2.53	201	0.70
25	1.29	82	19.43	136	0.26	202	0.32
26	5.48	83	7.39	137	0.81	203	1.20
27	16.14	84	3.04	138	0.45	205	15.34
28	22.05	85	2.19	139	2.39	206	0.90
29	17.16	86	0.47	140	0.85	207	2.36
31	15.91	87	1.22	141	3.18	208	0.29
32	2.64	88	1.73	142	0.20	209	0.81
33	1.59	89	3.32	143	1.61	211	0.71
35	0.19	90	1.44	144	1.43	213	6.93
36	0.35	91	7.50	145	18.30	214	0.76
37	1.16	92	0.68	146	1.88	215	1.69
38	1.30	93	9.43	147	1.07	216	0.13
39	11.48	94	1.26	148	0.13	217	1.26
40	1.62	95	7.61	149	0.77	218	0.16
41	7.61	96	2.07	151	27.73	219	0.18
42	13.07	97	3.27	152	0.99	221	0.92
43	55.91	98	1.24	153	1.04	223	0.91
44	7.50	99	9.55	154	0.30	225	0.26
45	3.64	100	2.16	155	1.75	226	0.15
46	1.33	101	8.86	156	0.29	227	0.60
47	6.19	102	1.58	157	1.42	228	0.22
48	0.45	103	8.18	159	13.86	229	0.13
49	2.33	104	2.10	160	0.53	230	0.29
50	5.60	105	1.82	161	1.07	231	0.70
51	19.09	106	0.77	163	2.64	233	100.00
52	3.44	107	4.77	165	8.86	234	7.50
53	13.64	108	0.81	167	2.78	235	0.45
54	5.31	109	6.19	168	0.30	236	0.11
55	20.11	110	0.49	169	1.05	237	0.17
56	7.39	111	0.97	171	1.38	239	0.08
57	18.86	112	2.93	173	2.30	243	0.33
58	2.93	113	10.34	174	0.84	245	0.74
59	10.68	114	2.67	175	2.70	246	0.18
60	1.04	115	8.75	176	0.45	247	0.77
61	0.92	116	1.35	177	2.84	249	0.12
62	1.54	117	1.75	178	0.33	251	74.09
63	6.45	118	0.33	179	0.24	252	5.40
64	3.01	119	2.76	181	0.92	254	0.11
65	11.14	120	0.53	183	3.92	255	0.28
66	1.96	121	6.51	185	11.25	257	0.24
67	5.17	122	0.93	186	0.60	259	0.15
69	65.91	123	1.90	187	1.46	261	0.17
70	1.04	124	0.18	188	0.55	263	0.85
71	8.98	125	0.72	189	0.50	265	2.13
72	1.24	126	1.07	191	4.01	266	0.26
73	4.15	127	6.82	192	0.23	267	0.38
74	1.19	128	0.63	193	1.46	275	0.40
75	5.06	129	3.81	194	1.77	277	1.43
76	1.82	130	1.15	195	3.15	279	0.20
77	20.00	131	8.98	196	0.89	281	0.32
78	1.22	132	7.50	197	2.44	283	0.39
285	0.40	306	0.18	326	0.99	347	1.61
295	0.36	315	0.17	327	0.61	365	0.38
297	2.98	317	1.43	333	0.34	367	2.05
303	0.17	323	0.19	345	1.41	368	0.13
305	1.42	325	9.32	346	0.20	373	1.36

Mass Spectrum 25: 4,6-Dimethyl-1,1,1,2,3,3,7,7,8,9,9,9-dodecafluorononane-4,6-diol

(94).

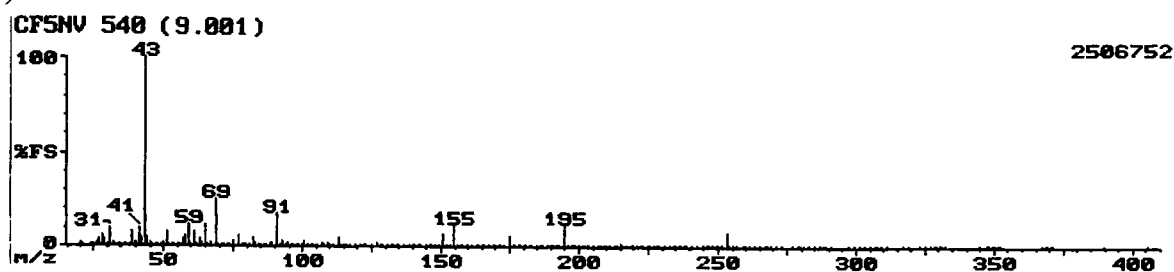

Mass	Rel Int	Mass	Rel Int	Mass	Rel Int	Mass	Rel Int
20	1.66	78	0.40	142	0.10	205	0.08
21	0.10	79	0.34	143	0.11	207	0.12
24	0.37	80	0.14	145	1.36	208	0.05
25	0.73	81	0.58	146	0.15	209	0.18
26	1.98	82	4.94	147	1.31	210	0.03
27	3.59	83	1.63	148	0.08	211	0.03
28	5.80	84	0.41	149	0.18	213	0.22
29	3.59	85	1.12	151	6.54	214	0.06
30	0.18	86	0.14	152	0.24	215	2.00
31	9.64	87	0.99	153	0.67	216	0.16
32	1.69	88	0.58	155	11.76	217	0.23
33	1.32	89	1.80	156	0.66	219	0.52
34	0.04	91	17.16	157	0.41	220	0.04
35	0.15	92	0.62	158	0.08	221	0.23
36	0.19	93	2.70	159	0.70	222	0.02
37	1.05	94	1.16	160	0.11	223	0.07
38	1.30	95	1.64	161	0.12	225	0.05
39	8.09	96	0.25	163	0.22	226	0.04
40	2.06	97	0.44	164	0.04	227	0.15
41	9.68	98	0.06	165	0.17	228	0.04
42	5.19	99	0.30	166	0.03	229	0.09
43	100.00	100	0.41	167	0.25	231	0.04
44	4.74	101	3.23	168	0.03	233	0.16
45	1.59	102	0.30	169	0.27	234	0.05
46	0.52	103	1.02	170	0.11	235	0.83
47	1.18	104	0.35	171	0.85	236	0.06
48	0.11	105	0.32	172	0.81	237	0.21
49	0.58	107	1.75	173	1.31	238	0.01
50	1.75	108	0.31	175	6.25	239	0.11
51	7.48	109	2.01	176	0.40	241	0.05
52	0.36	110	0.11	177	0.45	243	0.03
53	0.85	111	0.32	178	0.06	245	0.15
54	0.16	113	5.15	179	0.14	246	0.06
55	1.05	114	0.39	180	0.03	247	0.11
56	0.48	115	0.46	181	0.17	248	0.02
57	3.43	116	0.09	182	0.03	249	0.18
58	6.29	117	0.20	183	0.12	250	0.02
59	11.27	119	0.42	185	0.11	251	0.04
60	0.87	121	0.81	186	0.03	253	7.80
61	7.68	122	0.16	187	0.16	254	0.60
62	0.80	123	0.22	189	0.22	255	0.07
63	4.21	125	0.26	190	0.03	257	0.02
64	1.93	127	1.99	191	0.47	259	0.23
65	11.27	128	0.16	192	0.53	260	0.02
66	0.48	129	0.61	193	0.17	261	0.03
67	1.51	131	0.91	195	11.93	263	0.11
69	25.49	132	1.14	196	0.73	265	0.14
70	0.65	133	1.21	197	0.36	267	0.09
71	1.40	134	0.11	198	0.05	268	0.01
72	0.25	135	0.33	199	0.13	269	0.07
73	0.77	137	0.42	200	0.24	271	0.03
74	0.53	139	0.58	201	0.18	273	0.02
75	2.56	140	0.07	202	0.03	277	0.07
77	6.09	141	0.61	203	0.08	279	0.26
280	0.02	303	0.20	328	0.04	352	0.12
281	0.05	305	0.06	329	0.15	367	0.17
283	0.10	307	0.26	330	0.01	368	0.02
285	0.02	308	0.03	331	0.08	369	0.35
287	0.29	309	0.06	332	0.01	370	0.03
288	0.04	311	0.02	345	0.02	371	0.15
289	0.02	317	0.03	347	0.66	389	0.08
291	0.01	319	0.02	348	0.06	405	0.09
297	0.01	323	0.03	349	0.55		
299	0.20	325	0.04	350	0.05		
301	0.01	327	0.34	351	1.43		

Mass Spectrum 26: 4,7-Dimethyl-1,1,1,2,3,3,8,8,9,10,10,10-dodecafluorodecane-4,7-diol (97).

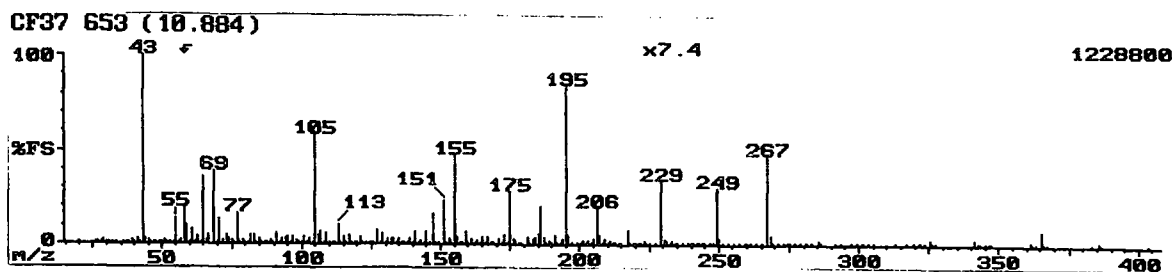

Mass	Rel Int	Mass	Rel Int	Mass	Rel Int	Mass	Rel Int
20	0.01	82	0.61	136	0.06	193	0.15
26	0.09	83	0.61	137	0.18	194	0.36
27	1.01	84	0.11	138	0.04	195	11.42
28	0.89	85	0.38	139	0.41	196	0.64
29	1.79	86	0.05	140	0.10	197	0.19
30	0.09	87	0.11	141	0.94	199	0.11
31	0.96	88	0.06	142	0.09	200	0.02
32	0.24	89	0.31	143	0.27	201	0.24
33	0.19	90	0.12	144	0.04	202	0.03
36	0.22	91	0.82	145	0.99	203	0.27
37	0.05	92	0.05	146	0.11	204	0.02
38	0.07	93	0.41	147	2.25	205	0.44
39	1.50	94	0.33	148	0.12	206	2.60
40	0.35	95	0.48	149	0.07	207	0.61
41	2.71	96	0.16	151	3.17	208	0.10
42	1.09	97	0.54	152	0.12	209	0.36
43	100.00	98	0.22	153	0.35	210	0.05
44	2.92	99	0.15	154	0.13	211	0.32
45	1.75	100	0.08	155	6.50	212	0.05
46	0.26	101	0.53	156	0.52	213	0.16
47	1.22	102	0.07	157	0.14	214	0.08
48	0.07	103	0.34	158	0.03	215	0.11
49	0.37	104	0.12	159	0.86	217	1.03
50	0.62	105	7.92	160	0.08	218	0.10
51	1.75	106	0.63	161	0.41	219	0.11
52	0.13	107	0.91	162	0.04	220	0.02
53	0.79	108	0.16	163	0.24	221	0.18
54	0.25	109	0.77	164	0.06	222	0.03
55	13.42	110	0.10	165	0.54	223	0.29
56	1.22	111	0.13	166	0.07	224	0.03
57	1.73	112	0.05	167	0.51	225	0.07
58	2.69	113	1.40	168	0.05	227	0.07
59	1.33	114	0.10	169	0.19	229	4.56
60	0.14	115	0.53	171	0.41	230	0.44
61	1.03	116	0.09	172	0.05	231	0.31
62	0.06	117	0.60	173	0.61	232	0.04
63	0.59	118	0.06	174	0.13	233	0.21
64	0.17	119	0.17	175	3.85	234	0.02
65	4.83	120	0.03	176	0.34	235	0.08
66	0.22	121	0.50	177	0.24	237	0.04
67	0.66	122	0.11	178	0.02	239	0.05
69	5.33	123	0.17	179	0.06	240	0.11
70	0.16	124	0.03	181	0.48	241	0.09
71	1.81	125	0.11	182	0.05	242	0.03
72	0.21	126	0.05	183	0.35	243	0.04
73	0.68	127	1.11	184	0.55	244	0.04
74	0.38	128	0.12	185	0.84	245	0.07
75	0.26	129	0.77	186	2.71	247	0.07
76	0.07	130	0.08	187	0.57	248	0.02
77	2.25	131	0.34	188	0.09	249	4.04
78	0.14	132	0.38	189	0.28	250	0.39
79	0.24	133	0.36	190	0.04	251	0.11
80	0.17	134	0.06	191	0.63	253	0.08
81	0.16	135	0.34	192	0.07	255	0.03
257	0.03	277	0.09	313	0.08	346	0.02
259	0.09	279	0.05	317	0.12	347	0.14
260	0.02	281	0.10	319	0.02	361	0.25
261	0.08	283	0.03	321	0.19	362	0.04
263	0.07	285	0.22	322	0.02	363	0.06
265	0.05	286	0.02	323	0.09	365	1.07
267	6.50	291	0.04	325	0.35	366	0.13
268	0.63	293	0.13	326	0.05	367	0.06
269	0.07	297	0.08	327	0.04	383	0.03
271	0.03	299	0.02	341	0.42	385	0.23
273	0.13	301	0.09	342	0.05	386	0.03
274	0.02	303	0.20	343	0.08	403	0.04
275	0.02	305	0.02	345	0.18		

Mass Spectrum 27: 4-Methyl-1,1,1,2,3,3-hexafluorooctane-4,7-diol (96).

CF192 588 (9.801)

55296

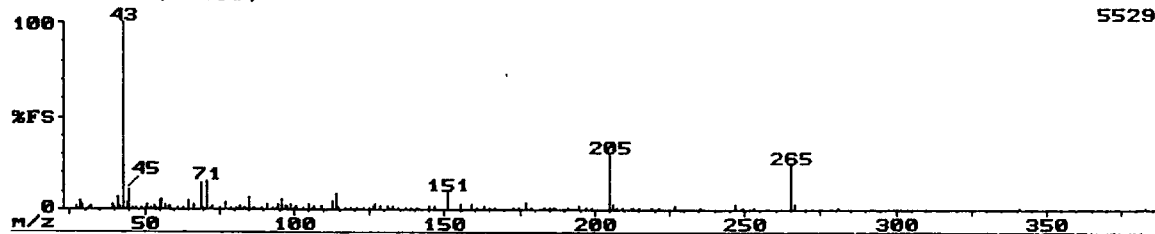

Mass	Rel Int	Mass	Rel Int	Mass	Rel Int	Mass	Rel Int
27	2.00	70	1.10	113	4.75	179	0.86
28	5.09	71	15.16	114	8.68	183	1.28
29	2.72	72	1.17	115	2.29	185	0.72
31	1.31	73	2.00	117	0.95	186	0.98
32	1.58	75	0.73	119	0.52	187	0.48
39	3.13	77	3.50	121	0.85	191	0.56
40	0.86	79	0.80	123	0.39	195	1.54
41	6.92	81	1.23	125	0.49	197	0.64
42	1.71	82	1.94	126	1.56	199	0.56
43	100.00	83	1.43	127	2.72	205	29.63
44	4.31	84	0.52	129	1.80	206	3.33
45	10.76	85	7.20	131	2.08	207	0.96
46	0.51	86	0.64	132	0.75	209	0.43
47	0.91	87	0.95	133	1.48	212	0.59
49	0.45	89	1.10	135	0.48	213	0.80
50	0.54	91	2.81	137	1.12	215	0.64
51	3.01	93	0.62	139	0.63	219	0.92
52	0.49	94	0.54	141	1.39	221	0.49
53	2.17	95	2.95	145	2.40	227	2.00
54	0.46	96	5.35	147	1.77	235	0.75
55	5.24	97	1.77	151	9.38	247	3.30
56	6.16	98	1.65	155	3.36	249	0.61
57	3.04	99	2.81	159	3.39	253	0.51
58	2.29	100	0.71	161	0.53	265	24.33
59	1.55	101	1.91	163	2.08	266	2.66
61	0.84	103	1.30	165	0.81	281	0.48
63	1.16	105	2.52	167	0.28	341	0.75
65	4.43	106	0.33	173	0.92	383	1.00
67	2.72	107	1.58	175	1.17		
69	14.12	109	2.14	177	4.11		

Mass Spectrum 28: 1,1,1,2,3,3,7,7,8,9,9,9-Dodecafluorononane-4,6-diol (100).

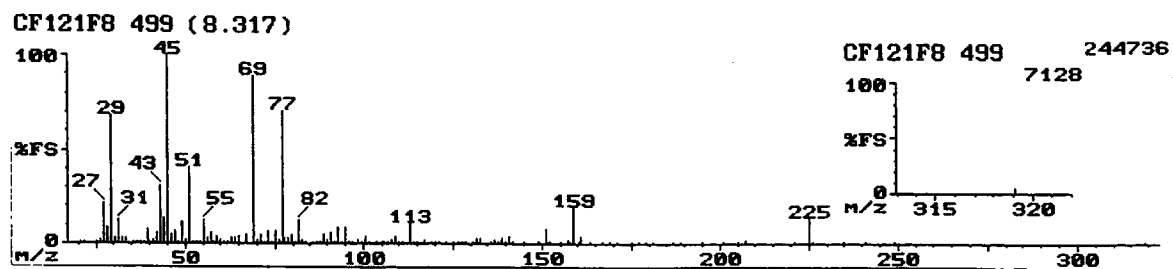

Mass	Rel Int	Mass	Rel Int	Mass	Rel Int	Mass	Rel Int
21	0.34	58	1.10	95	8.26	140	0.16
22	0.14	59	3.95	96	0.34	141	4.11
25	0.14	60	1.91	97	0.41	142	0.18
26	1.73	61	1.14	99	2.01	145	0.96
27	21.13	62	1.17	100	0.74	149	0.18
28	8.26	63	2.88	101	3.61	151	8.05
29	68.20	64	2.88	102	0.28	152	0.31
30	2.46	65	3.63	104	0.30	155	0.35
31	12.97	67	4.79	105	0.28	157	2.09
32	2.75	69	89.54	106	1.07	158	0.34
33	3.11	70	1.75	107	1.20	159	19.04
35	0.18	71	4.63	108	1.50	160	0.58
36	0.35	72	0.46	109	3.69	161	4.03
37	0.50	73	6.90	110	0.16	163	0.16
38	1.06	74	0.71	111	0.95	167	0.39
39	7.64	75	7.22	113	10.67	169	0.16
40	0.88	76	1.50	114	0.38	171	0.21
41	1.75	77	70.71	115	0.41	175	0.27
42	5.60	78	2.88	117	1.49	177	0.46
43	30.96	79	3.01	119	1.31	179	0.23
44	13.70	80	5.05	120	0.20	181	1.12
45	100.00	81	0.56	121	0.78	187	0.54
46	4.45	82	12.87	123	0.09	189	0.33
47	7.11	83	2.17	125	0.57	195	0.17
48	0.20	84	0.19	127	0.95	201	0.30
49	11.19	86	0.41	128	0.16	205	0.41
50	1.75	87	0.49	129	1.38	207	1.96
51	40.59	88	0.87	131	1.10	221	0.44
52	1.09	89	4.42	132	2.82	225	13.39
53	1.10	90	2.01	133	3.22	226	0.85
54	0.61	91	5.83	136	0.27	235	0.21
55	12.24	92	0.27	137	1.78	241	0.13
56	2.43	93	8.47	138	0.21	249	0.21
57	6.15	94	1.07	139	2.93	319	0.17

Mass Spectrum 29: 1,1,1,2,3,3-Hexafluorohexane-4,6-diol (99).

CF239 499 (8.317)

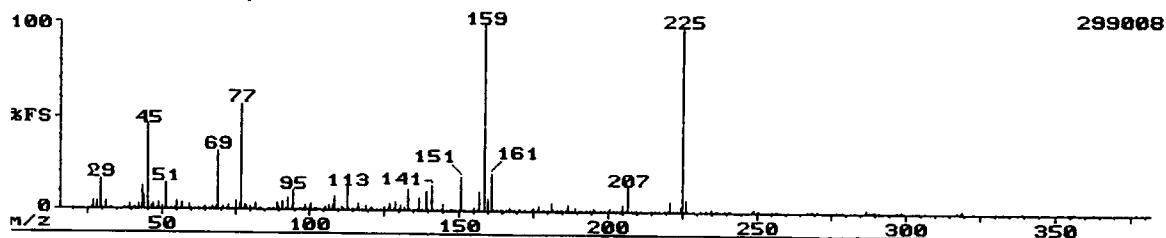

Mass	Rel Int	Mass	Rel Int	Mass	Rel Int	Mass	Rel Int
20	0.07	82	4.20	137	6.85	195	2.08
26	0.49	83	1.39	138	1.10	196	0.17
27	5.27	84	0.16	139	10.70	198	0.12
28	4.84	86	0.19	140	1.43	199	0.28
29	16.18	87	1.43	141	13.96	200	0.05
30	0.76	88	0.79	142	0.73	201	2.08
31	4.82	89	4.37	143	0.45	202	0.16
32	1.43	90	1.69	144	0.18	203	0.09
33	0.83	91	5.31	145	4.11	204	0.14
37	0.26	92	0.52	146	0.25	205	3.72
38	0.55	93	6.51	147	0.20	206	0.79
39	2.80	94	1.18	148	0.36	207	13.70
40	0.45	95	10.27	149	1.32	208	1.02
41	1.06	96	0.48	150	0.96	209	1.14
42	2.80	97	0.72	151	18.41	210	0.06
43	12.24	98	0.12	152	0.74	211	0.11
44	7.71	99	2.74	155	1.63	215	0.17
45	45.55	100	0.32	156	1.22	216	0.06
46	1.97	101	3.79	157	10.45	217	0.92
47	2.50	102	0.30	159	100.00	219	0.27
48	0.29	103	0.15	160	6.76	220	0.17
49	3.66	104	0.42	161	20.38	221	5.46
50	1.52	105	0.82	162	1.08	222	0.46
51	14.47	106	1.69	163	0.91	223	0.52
52	0.49	107	2.50	164	0.07	224	2.72
53	0.40	108	2.91	165	0.11	225	98.63
54	0.42	109	7.79	166	0.12	226	6.51
55	4.92	110	0.52	167	2.31	227	0.87
56	1.02	111	1.63	168	0.16	229	0.16
57	4.17	112	0.63	169	0.81	231	0.33
58	1.41	113	12.41	170	0.24	233	0.18
59	2.44	114	0.62	171	1.04	234	0.06
60	0.87	115	0.92	172	0.10	235	1.54
61	0.93	116	0.08	173	0.31	236	0.12
62	0.57	117	3.51	174	0.10	237	0.62
63	1.15	118	0.16	175	1.58	239	0.20
64	1.29	119	2.72	176	0.25	240	0.06
65	2.40	120	0.24	177	2.87	241	1.27
66	0.11	121	2.20	178	0.14	248	0.07
67	2.18	122	0.18	179	1.41	249	1.71
68	1.90	123	0.51	180	0.27	250	0.10
69	32.19	124	0.11	181	5.22	251	0.93
70	0.86	125	2.12	182	0.34	255	0.31
71	2.40	126	0.17	183	0.34	257	0.13
72	0.35	127	3.62	184	0.06	267	0.21
73	3.36	128	0.36	185	1.07	268	0.08
74	0.50	129	4.90	186	0.32	269	1.41
75	4.41	130	0.16	187	3.68	270	0.16
76	2.78	131	2.59	188	0.38	271	0.81
77	57.53	132	2.01	189	1.65	277	0.94
78	2.48	133	11.56	190	0.12	279	0.06
79	2.18	134	0.25	191	0.17	287	1.48
80	1.97	135	0.46	193	0.25	288	0.12
81	0.49	136	0.60	194	0.15	289	1.35
290	0.14	298	0.06	318	0.10	356	0.48
291	0.16	299	0.87	319	1.93	377	0.09
297	0.44	317	0.80	339	0.45		

Mass Spectrum 30: 1,1,1,2,3,3,8,8,9,10,10,10-Dodecafluorodecane-4,7-diol (9).

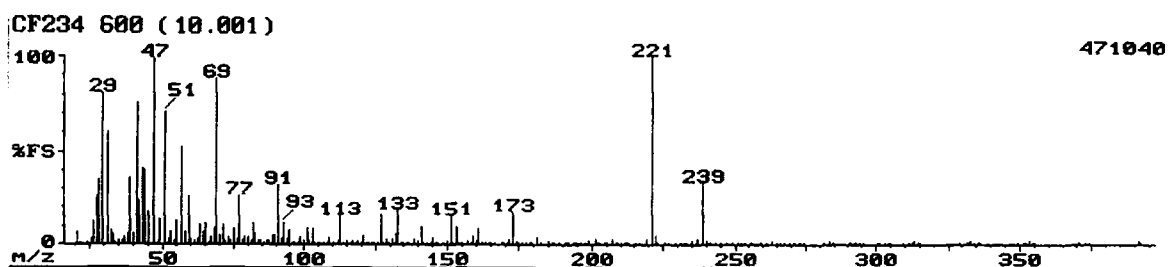

Mass	Rel Int	Mass	Rel Int	Mass	Rel Int	Mass	Rel Int
20	6.63	80	3.70	134	1.32	197	0.16
22	0.09	81	1.62	135	0.57	199	1.67
24	1.10	82	11.90	136	0.31	201	2.57
25	2.53	83	6.09	137	0.40	202	0.31
26	12.23	84	2.28	139	2.53	203	0.92
27	26.30	85	2.42	140	1.98	204	0.07
28	34.78	86	0.81	141	10.00	205	0.51
29	80.87	87	1.97	142	0.98	207	2.53
31	60.00	88	1.67	143	0.78	209	0.58
32	7.39	89	5.05	144	0.40	209	0.56
33	5.54	90	5.11	145	3.46	210	0.11
34	0.06	91	31.96	146	0.61	211	0.26
35	1.93	92	2.79	147	0.34	212	0.12
36	1.71	93	12.01	149	0.73	213	0.31
37	3.64	94	2.55	150	1.59	215	0.72
38	6.30	95	8.21	151	15.87	217	0.11
39	36.09	96	0.63	152	1.43	219	3.37
40	5.65	97	0.73	153	9.57	221	100.00
41	75.65	98	0.37	154	0.83	222	4.84
42	23.26	99	3.53	155	0.54	223	0.96
43	40.65	100	1.94	157	1.77	225	0.09
44	39.35	101	8.37	158	0.67	227	0.19
45	17.17	102	2.05	159	4.89	229	0.09
47	99.13	103	8.80	160	1.77	231	0.46
48	1.14	104	0.69	161	9.13	232	0.09
49	13.91	105	0.58	162	0.90	233	0.19
51	71.30	106	0.85	163	1.10	235	1.58
52	2.73	107	1.13	165	0.43	237	2.99
53	6.41	108	1.39	165	0.23	239	33.48
54	1.83	109	3.86	167	0.60	240	1.81
55	12.39	110	0.22	169	0.53	241	0.30
57	52.61	111	0.79	170	0.53	243	0.49
58	6.36	112	2.09	171	1.24	245	0.72
59	25.87	113	15.65	172	2.68	247	0.23
60	3.32	114	1.41	173	17.61	249	0.67
61	2.32	115	1.90	174	1.47	251	0.52
62	2.92	116	0.21	175	0.96	252	0.10
63	10.60	117	1.85	176	0.87	253	0.31
64	6.90	118	0.24	177	1.15	255	0.30
65	11.68	119	1.83	179	0.29	256	0.04
66	1.41	120	0.41	179	0.18	259	0.07
67	3.97	121	4.89	181	4.29	261	0.10
68	8.42	122	0.79	183	0.87	263	1.48
69	88.70	123	0.95	185	1.83	265	0.99
70	5.16	124	0.35	186	0.28	266	0.10
71	10.92	125	0.68	187	0.99	267	0.07
72	2.42	126	1.20	189	1.11	269	0.14
73	3.70	127	16.30	191	0.51	270	0.08
74	1.96	128	1.01	191	0.53	271	0.39
75	8.91	129	2.73	192	0.78	272	0.05
76	3.30	130	0.51	194	1.10	273	0.15
77	25.87	131	2.51	195	1.44	275	0.04
78	1.55	132	5.76	195	0.74	281	0.12
79	3.70	133	18.91	196	0.09	283	2.04
284	0.11	303	0.88	331	0.17	354	0.09
285	0.85	304	0.09	332	0.19	355	0.18
290	0.18	305	0.17	333	1.70	370	0.42
291	0.48	309	0.08	334	0.13	371	0.43
292	0.08	311	0.99	335	0.30	373	0.68
293	0.68	312	0.20	336	0.12	374	0.07
294	0.10	313	1.85	349	0.09	391	1.74
295	0.03	314	0.15	351	0.40	392	0.16
300	0.06	315	0.12	352	0.71		
301	0.49	329	0.07	353	1.86		

Mass Spectrum 31: 1,1,1,2,3,3-Hexafluoroheptane-4,7-diol (8).

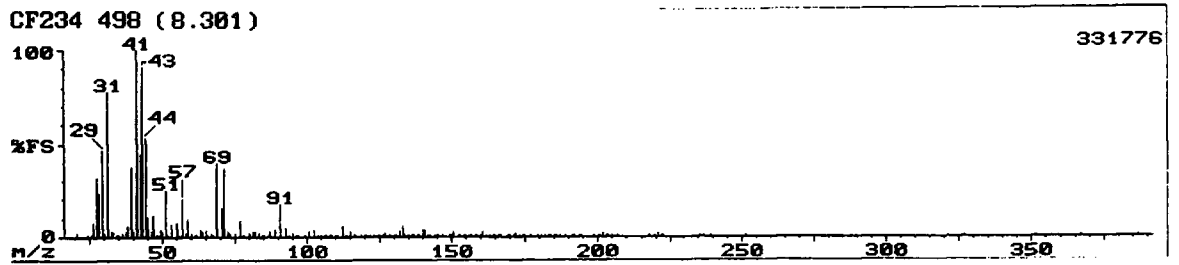

Mass	Rel Int	Mass	Rel Int	Mass	Rel Int	Mass	Rel Int
20	1.99	67	1.56	122	0.53	166	0.05
24	0.39	68	0.56	123	1.03	167	0.15
25	0.87	69	39.81	124	0.08	169	0.15
26	7.41	70	15.82	125	0.16	170	1.02
27	31.79	71	37.04	126	0.35	171	0.50
28	23.46	72	3.16	127	1.77	172	2.16
29	46.60	73	1.91	128	0.30	173	0.79
30	2.04	75	1.89	129	0.86	174	0.20
31	77.78	77	9.18	130	0.25	175	0.20
32	3.28	78	0.34	131	1.04	177	0.14
33	2.43	80	2.12	132	2.51	179	0.06
34	0.07	81	2.57	133	6.17	181	0.53
35	0.83	82	3.20	134	0.50	182	0.40
36	2.31	83	2.04	135	1.25	183	0.38
37	2.72	84	0.29	136	0.10	184	0.10
38	5.79	85	1.23	137	0.15	185	0.22
39	37.65	87	2.43	138	0.16	186	0.42
40	3.03	89	4.26	139	1.23	187	0.11
41	100.00	91	17.90	140	4.30	189	0.10
42	44.75	93	4.53	141	3.80	191	0.11
43	91.36	94	0.82	142	1.29	192	0.98
44	53.70	95	2.06	143	0.28	194	1.02
45	10.42	96	0.17	144	0.15	195	0.06
46	2.45	97	0.42	145	0.85	199	0.11
47	11.81	99	0.43	146	0.13	201	0.18
48	0.23	101	3.30	147	0.08	202	1.72
49	3.57	103	3.78	149	0.09	203	0.28
50	2.45	104	0.41	150	0.69	204	0.15
51	25.00	105	0.22	151	3.40	205	0.42
52	0.71	106	0.08	152	0.16	207	0.19
53	7.25	107	0.33	153	0.50	218	0.10
55	7.87	108	0.41	154	0.27	220	1.29
56	0.69	109	0.74	155	0.68	221	1.89
57	20.37	110	0.14	156	0.13	222	0.08
58	2.18	111	0.16	157	0.52	223	0.70
59	9.72	113	5.94	158	0.24	235	0.11
60	2.12	114	0.77	159	1.03	237	0.18
61	1.03	115	2.49	160	1.13	239	0.16
62	1.21	116	0.40	161	3.11	251	0.17
63	4.22	117	0.79	162	0.34	327	0.17
64	2.97	119	0.59	163	0.54	367	0.18
65	4.03	120	0.32	164	0.06	387	0.44
66	0.13	121	1.43	165	0.17		

Mass Spectrum 32: 4-Methyl-1,1,2,3,3-hexafluorohexane-4,6-diol (102a).

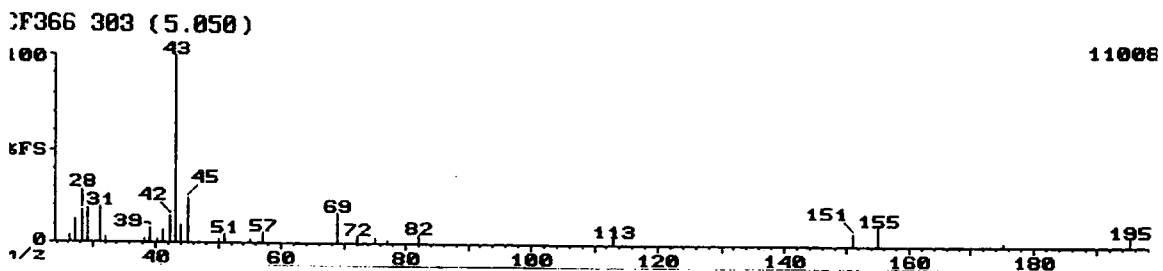

Mass	Rel Int	Mass	Rel Int	Mass	Rel Int	Mass	Rel Int
26	3.56	39	8.10	50	1.85	77	2.17
27	12.65	40	2.07	51	4.91	82	4.40
28	17.01	41	7.19	55	2.29	113	3.71
29	18.60	42	14.24	57	5.78	151	6.76
31	19.04	43	100.00	69	16.86	155	10.32
32	3.34	44	10.17	72	4.22	175	2.40
38	1.74	45	24.42	75	2.80	195	5.12

Mass Spectrum 33: 1,1,2,3,3-hexafluoroheptane-4,6-diol (102b).

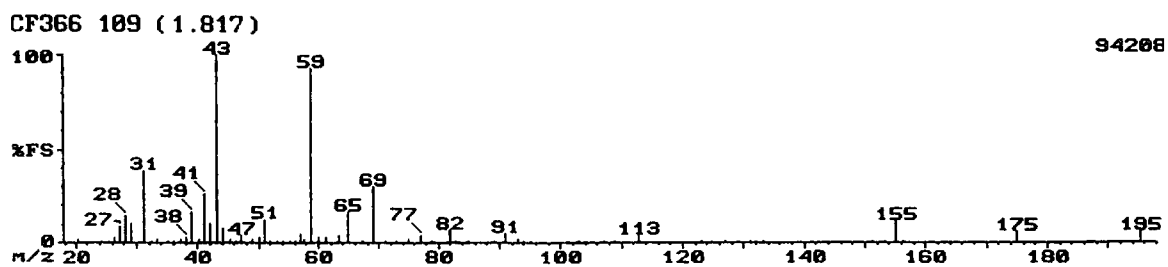

Mass	Rel Int	Mass	Rel Int	Mass	Rel Int	Mass	Rel Int
26	1.72	44	18.75	69	6.55	113	2.53
27	4.46	45	1.58	75	0.71	127	0.84
28	100.00	47	3.57	77	2.83	129	0.74
29	6.21	49	0.76	79	2.46	133	0.62
31	18.01	51	3.65	82	1.40	151	1.00
32	44.05	55	0.72	89	0.69	155	13.84
36	1.10	57	1.73	91	2.15	156	1.19
37	0.85	58	9.45	93	0.66	175	7.40
38	1.64	59	81.55	94	0.73	191	0.81
39	5.80	60	1.46	95	0.76	195	11.16
40	3.57	61	1.04	96	0.95	196	0.75
41	11.90	63	0.70	101	0.83	207	7.37
42	5.06	65	7.78	103	1.49	208	1.06
43	72.62	67	0.73	107	0.61	209	1.00

Mass Spectrum 34: 4-Methyl-1,1,1,2,3,3,7,7,8,9,9,9-dodecafluorononane-4,6-diol

(103).

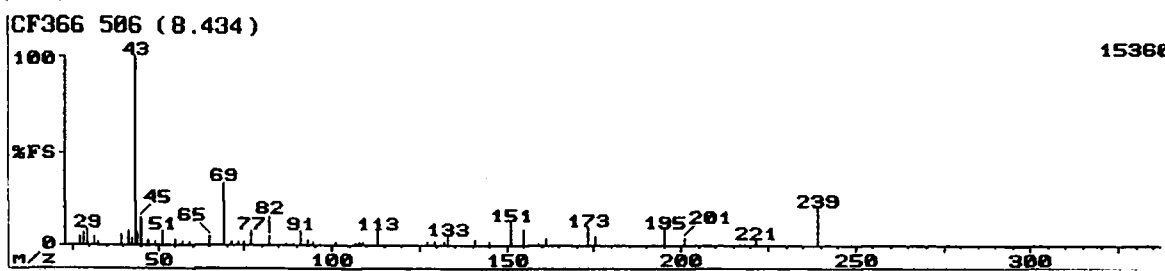

Mass	Rel Int	Mass	Rel Int	Mass	Rel Int	Mass	Rel Int
27	4.82	51	7.81	91	8.23	145	1.90
28	6.41	55	2.47	93	2.60	151	12.40
29	9.17	57	1.95	95	2.24	155	8.33
31	4.92	59	2.24	101	2.16	159	1.35
32	1.85	65	5.21	107	1.43	161	3.62
39	5.83	69	33.75	108	2.08	173	9.38
41	7.29	71	1.62	109	1.82	175	4.69
42	4.06	73	2.08	113	7.81	195	8.85
43	100.00	75	1.65	127	2.16	201	4.27
44	6.67	77	7.40	129	1.69	221	3.13
45	14.90	82	5.16	132	1.57	239	20.63
47	3.23	87	1.25	133	4.82	333	1.18
49	1.95	89	1.04	141	3.05		

Mass Spectrum 35: 4-Methyl-1,1,2,3,3-hexafluorooctane-4,8-diol (105a).

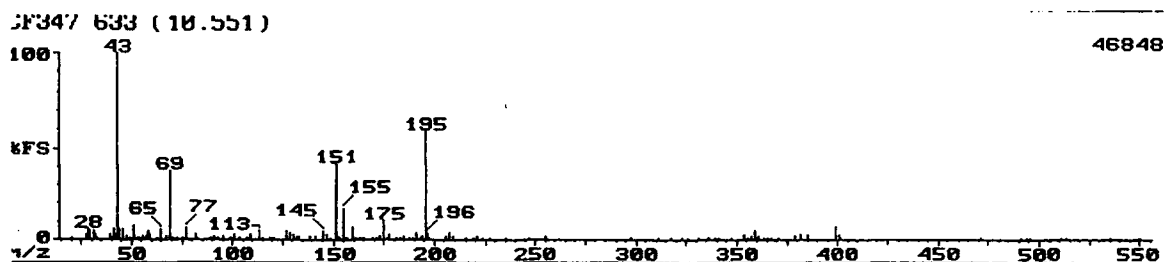

Mass	Rel Int	Mass	Rel Int	Mass	Rel Int	Mass	Rel Int
20	0.41	82	3.38	163	1.06	323	0.68
27	3.07	83	0.85	165	1.05	325	0.35
28	5.98	89	0.79	169	0.76	331	0.85
29	5.33	91	2.36	171	0.74	335	0.79
31	5.09	93	1.10	173	2.19	336	0.43
32	2.87	95	1.90	175	10.38	339	0.48
33	0.61	99	0.88	176	0.80	341	0.64
39	2.94	101	2.60	177	2.66	347	0.64
40	0.81	103	0.68	181	1.09	353	3.01
41	5.53	107	1.08	183	0.79	355	1.42
42	2.53	109	3.01	185	1.49	357	2.36
43	100.00	113	4.58	187	0.64	359	6.63
44	5.74	115	1.14	189	1.11	360	0.97
45	5.84	119	0.45	191	3.83	361	1.73
47	2.42	121	1.33	193	0.72	363	0.48
49	0.75	127	5.12	194	2.25	365	0.62
51	7.51	129	4.00	195	59.56	367	1.08
53	0.95	131	3.04	196	3.45	371	1.14
54	0.40	132	1.67	197	0.53	379	2.19
55	2.04	133	1.99	205	2.22	381	3.42
56	1.42	139	2.29	207	3.45	385	2.97
57	2.32	141	2.06	209	2.11	399	6.23
58	4.47	145	5.33	215	0.70	400	3.38
59	2.70	147	3.11	219	0.54	401	0.44
63	1.20	149	1.18	221	1.76	471	0.66
65	6.05	151	42.08	223	0.81	491	0.43
67	1.75	152	1.67	227	0.68	493	0.70
69	37.70	153	0.62	235	0.98	495	0.83
70	0.76	155	17.35	247	0.91	511	0.45
71	1.36	156	0.97	255	1.71	513	1.13
73	1.05	157	1.26	297	0.68	535	0.62
75	0.78	159	6.83	311	0.68	549	0.40
77	6.76	161	0.95	317	0.51		

Mass Spectrum 36: 1,1,2,3,3-Hexafluorononane-4,8-diol (105b).

CF347 588 (9.801)

72704

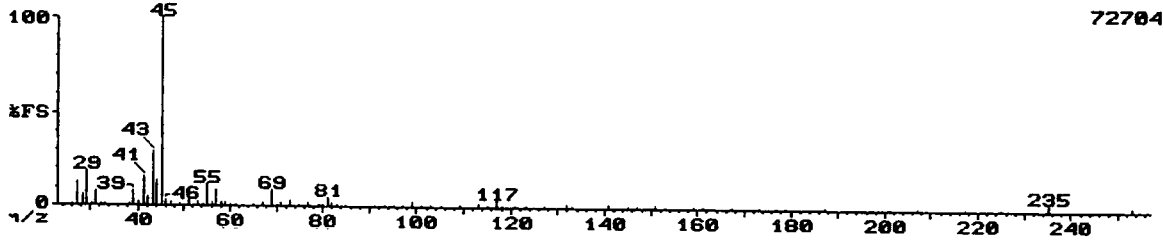

Mass	Rel Int	Mass	Rel Int	Mass	Rel Int	Mass	Rel Int
26	0.97	51	3.39	80	0.78	123	0.48
27	12.15	53	1.58	81	4.53	127	1.38
28	5.99	54	0.73	82	1.69	132	1.52
29	18.31	55	11.88	83	0.81	133	0.54
30	0.89	56	1.54	85	0.56	141	2.05
31	7.57	57	8.54	91	0.42	145	0.73
32	1.31	58	2.00	93	0.58	147	0.37
33	0.47	59	1.56	95	0.55	151	1.52
38	0.50	60	0.36	97	0.32	159	1.24
39	7.92	61	1.33	99	2.46	161	0.63
40	1.63	65	1.30	101	0.55	167	1.00
41	15.32	67	1.50	103	0.78	173	0.50
42	5.22	69	8.45	105	0.30	187	0.63
43	29.58	70	0.85	109	0.41	207	0.65
44	13.56	71	1.61	113	2.20	217	0.84
45	100.00	73	2.77	115	0.40	225	0.46
46	3.04	75	0.69	117	4.05	235	3.83
47	1.94	77	1.89	118	0.30	253	1.67
49	0.99	79	0.83	121	0.66		

Mass Spectrum 37: 4-Methyl-1,1,1,2,3,3,9,9,10,11,11,11-dodecafluoroundecane-4,8-diol (103).

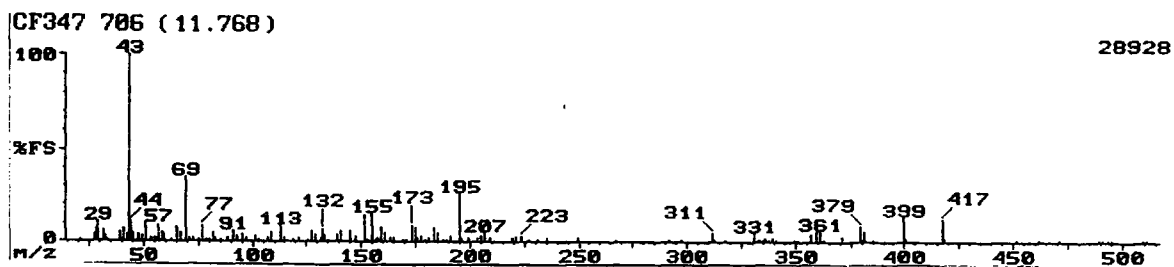

Mass	Rel Int	Mass	Rel Int	Mass	Rel Int	Mass	Rel Int
20	0.63	85	0.62	169	0.70	333	1.19
27	4.20	89	1.60	171	1.44	335	0.53
28	6.64	91	5.86	173	8.30	336	2.23
29	10.95	93	2.70	175	7.36	337	0.94
31	5.42	95	3.60	176	1.52	339	1.65
32	3.03	97	1.51	177	3.32	341	0.77
33	1.24	101	3.25	179	0.59	349	0.82
39	4.65	103	0.98	181	2.03	350	1.18
40	1.18	107	1.62	183	7.52	351	1.37
41	6.97	109	4.42	185	5.14	357	4.15
42	3.71	113	8.57	187	1.20	359	5.59
43	100.00	115	2.35	189	1.26	361	6.03
44	10.95	119	1.23	191	3.25	362	0.54
45	4.98	121	2.10	195	25.88	371	2.61
47	3.40	125	0.73	196	1.89	379	8.41
49	2.67	127	5.75	199	1.89	380	1.16
51	10.07	129	4.09	203	2.31	381	5.86
53	1.47	131	1.87	205	3.01	382	0.95
55	2.41	132	6.91	207	4.48	385	0.88
56	0.91	133	4.20	209	2.32	399	13.11
57	3.54	135	1.27	219	1.55	400	1.89
58	5.31	139	3.82	221	2.78	417	12.83
59	3.65	141	5.70	223	3.21	418	1.95
63	1.37	145	6.25	227	1.04	451	0.70
65	7.85	147	2.52	231	1.13	461	0.91
67	5.09	151	14.82	235	1.53	471	0.93
69	34.96	152	0.87	249	1.60	489	0.71
71	2.13	153	1.18	267	1.26	491	1.36
73	1.99	155	15.71	291	1.13	493	0.67
75	1.11	156	1.18	297	0.86	495	1.19
77	9.18	157	1.52	311	4.65	509	0.69
79	1.27	159	7.74	312	0.55	511	1.09
80	0.91	161	4.48	317	0.94		
82	4.65	163	1.56	331	4.98		
83	1.60	165	1.67	332	0.66		

Mass Spectrum 38: α -(1,1,1,2,3,3-Hexafluoropropyl)-2-hydroxy-tetrahydrofuran
(x=1,4) (Major product) (109).

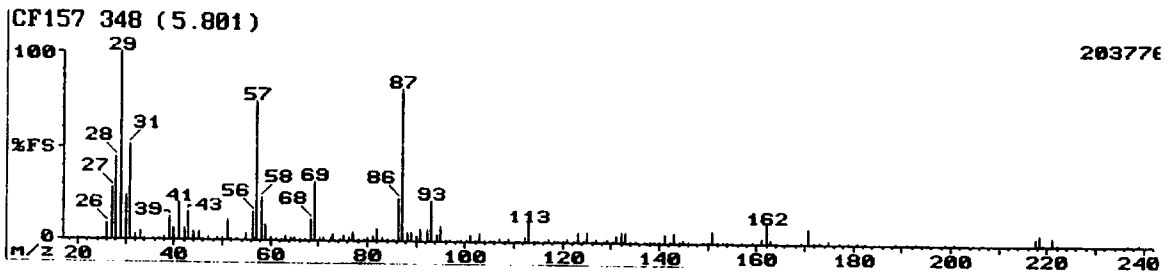

Mass	Rel Int	Mass	Rel Int	Mass	Rel Int	Mass	Rel Int
26	10	39	13	58	22	93	21
27	29	41	18	68	13	113	12
28	44	43	15	69	31	162	12
29	100	51	11	86	22	171	10
30	23	56	15	87	82	218	9
31	51	57	76				

Mass Spectrum 39: 2-(1,1,1,2,3,3-Hexafluoropropyl)-2-hydroxy-tetrahydrofuran
(Lesser product) (109).

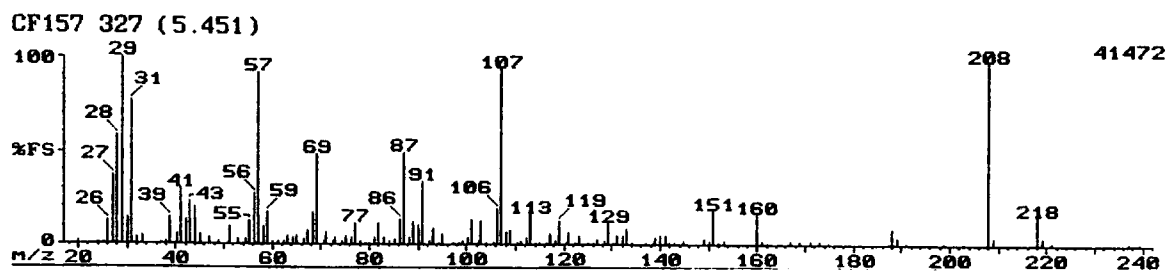

Mass	Rel Int	Mass	Rel Int	Mass	Rel Int	Mass	Rel Int
26	13	44	19	86	14	119	14
27	38	51	10	87	51	129	13
28	59	55	12	91	36	133	10
29	100	56	28	101	15	151	19
31	78	57	93	103	14	160	18
39	15	59	18	106	20	178	11
41	30	68	18	107	92	208	99
42	14	69	50	113	17	218	18
43	21	77	12				

Mass Spectrum 40: Tetrahydrofurfuryl-1,1,2,3,3,3-hexafluoropropyl ether (112).

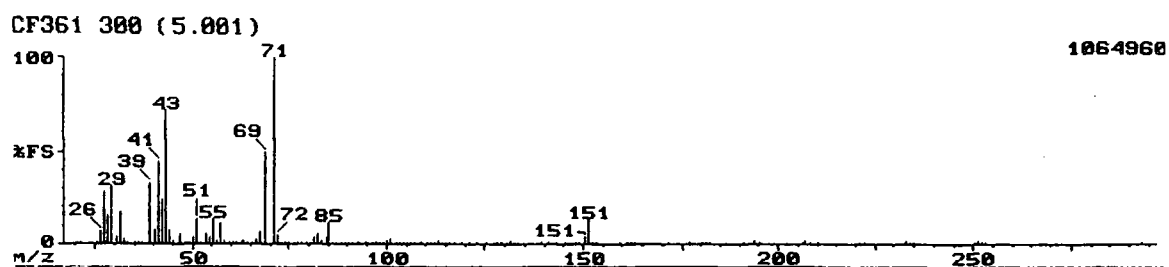

Mass	Rel Int	Mass	Rel Int	Mass	Rel Int	Mass	Rel Int
20	1.17	60	1.06	97	0.07	145	0.03
21	0.04	61	0.30	98	0.09	148	0.05
24	0.50	63	1.56	99	0.43	149	0.09
25	1.36	63	2.38	100	1.56	151	3.68
26	6.54	64	0.85	101	2.86	151	13.75
27	28.46	65	0.80	102	0.22	152	0.42
28	15.48	67	3.25	103	0.66	153	0.04
29	31.15	67	6.63	104	0.05	159	0.02
30	3.92	69	49.62	105	0.04	161	0.06
31	17.88	71	100.00	106	0.02	162	0.20
32	2.84	72	4.38	107	0.05	163	0.11
33	0.82	73	0.88	108	0.08	171	0.03
35	0.40	74	0.69	109	0.24	177	0.04
36	0.30	75	0.65	110	0.19	180	0.03
37	1.41	76	0.14	111	0.18	181	0.91
39	32.69	77	0.24	112	0.84	182	0.05
40	7.40	78	0.11	113	2.31	191	0.20
41	45.00	79	0.20	114	0.11	194	1.56
42	24.33	80	0.72	115	0.03	195	0.10
43	72.31	81	4.04	116	0.02	206	0.05
44	8.17	82	6.25	117	0.01	207	1.66
45	1.73	83	1.90	119	0.05	208	0.24
47	5.84	85	4.04	121	0.04	210	0.06
48	0.13	85	11.44	123	0.02	220	0.03
49	0.32	86	0.85	125	0.15	221	0.13
50	4.11	87	0.87	127	0.10	222	0.07
51	13.17	88	0.09	128	0.47	232	0.10
52	1.05	89	0.13	129	0.77	233	2.28
53	5.36	90	0.34	130	0.34	234	0.29
54	4.23	91	1.00	131	1.59	235	0.13
55	13.65	92	0.30	132	0.59	250	0.21
56	1.92	93	1.15	133	0.24	251	1.68
57	12.12	94	0.21	139	0.02	252	0.09
58	1.54	95	0.35	141	0.03	253	0.12
59	1.36	96	0.07	143	0.03	293	0.06

Mass Spectrum 41: 1-(2-Hydro-perfluorocyclopentyl)-cyclopentan-1-ol (114).

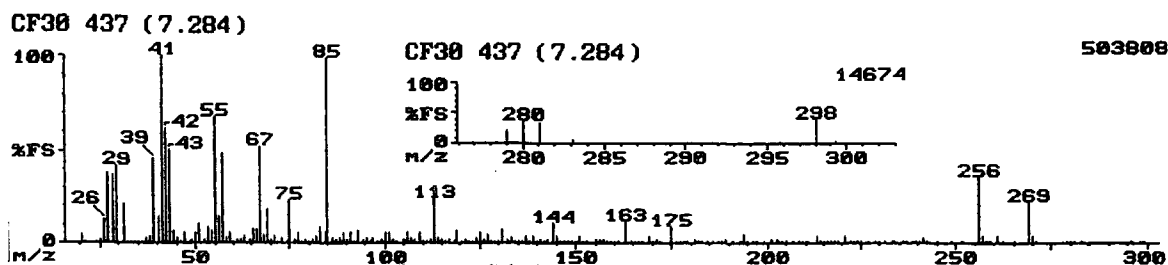

Mass	Rel Int	Mass	Rel Int	Mass	Rel Int	Mass	Rel Int
20	4.83	77	6.25	132	2.22	195	0.75
21	0.11	78	1.13	133	2.64	196	0.11
24	0.62	79	1.55	134	0.38	197	0.26
25	2.31	80	0.73	135	0.63	199	0.61
26	12.75	81	1.87	136	0.32	201	1.78
27	37.40	82	4.01	137	4.01	203	2.03
28	36.59	83	8.69	138	1.03	203	1.22
29	41.87	84	5.84	139	4.07	204	0.19
31	21.34	85	99.19	140	0.97	205	0.10
32	1.03	86	3.14	141	1.50	207	0.77
33	1.37	87	2.34	142	0.37	208	0.17
34	0.07	88	3.16	143	1.77	209	0.38
35	0.06	89	5.44	144	10.67	210	0.12
36	0.33	90	1.52	145	3.81	211	0.28
37	3.24	91	6.25	146	0.65	213	3.66
38	3.81	92	0.56	147	0.81	214	0.32
39	45.73	93	6.86	148	0.28	215	0.24
40	14.84	94	2.21	149	0.74	216	0.34
41	100.00	95	2.59	150	1.21	217	0.19
42	62.60	96	0.71	151	3.86	218	0.29
43	50.61	97	2.57	152	0.93	219	1.04
44	7.06	98	0.90	153	1.23	221	4.12
45	3.14	99	2.17	155	2.22	222	0.24
46	1.24	100	6.25	156	1.73	223	0.37
47	5.95	101	6.15	157	2.01	224	0.04
48	0.17	102	1.52	158	0.94	225	0.11
49	2.35	103	0.73	159	1.24	227	0.10
50	6.25	105	1.88	160	0.24	229	0.20
51	11.03	106	5.95	161	0.52	230	0.14
52	2.18	107	2.55	163	11.28	231	0.14
53	8.54	108	1.55	164	0.78	233	0.12
54	6.50	109	6.00	165	0.56	234	0.03
55	67.48	110	0.74	166	0.24	236	0.48
56	14.84	111	1.11	167	0.54	237	0.30
57	48.98	112	1.74	169	3.96	238	0.13
58	3.15	113	24.39	170	1.28	239	0.28
59	5.84	114	2.72	171	1.94	240	0.33
60	1.30	115	1.84	172	0.63	241	2.77
61	1.66	116	0.33	175	9.15	242	0.32
62	1.83	117	2.24	176	0.57	245	0.05
63	3.51	118	0.39	177	0.98	249	0.43
64	1.80	119	6.61	178	0.15	252	0.05
65	8.23	120	1.44	179	0.40	256	35.98
66	7.37	121	1.58	181	1.71	257	4.22
67	52.85	122	0.75	182	0.53	258	0.43
68	4.52	123	0.62	183	1.08	259	0.25
69	18.29	124	3.09	185	0.30	261	3.51
70	1.84	125	5.74	186	0.09	262	0.30
71	3.56	126	1.70	187	0.42	265	0.07
72	1.36	127	4.42	188	0.94	269	22.15
73	2.96	128	0.77	189	1.85	270	3.40
74	1.00	129	1.28	191	1.30	271	0.24
75	23.37	130	0.76	193	1.23	279	0.66
76	2.20	131	7.37	194	4.52	280	1.07
281	0.98	296	0.07	299	0.09		
283	0.19	298	1.14				

Mass Spectrum 42: 1-(2-Hydro-perfluorocyclohexyl)-cyclopentan-1-ol (115).

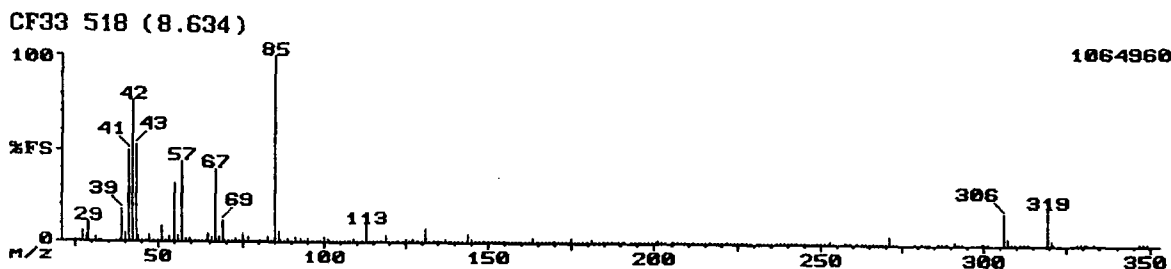

Mass	Rel Int	Mass	Rel Int	Mass	Rel Int	Mass	Rel Int
25	0.02	82	1.30	136	0.14	190	0.06
26	0.78	83	2.84	137	1.92	191	0.19
27	5.91	84	0.83	138	0.40	193	1.35
28	4.23	85	100.00	139	0.97	194	0.50
29	10.77	86	5.91	140	0.24	195	0.53
30	0.34	87	0.90	141	0.59	196	0.07
31	2.81	88	0.88	142	0.11	197	0.21
32	0.23	89	1.83	143	0.84	198	0.05
33	0.41	90	0.44	144	4.83	199	0.20
37	0.21	91	2.72	145	1.48	200	0.25
38	0.85	92	0.17	146	0.24	201	1.46
39	17.50	93	2.14	147	0.29	202	0.35
40	4.74	94	1.09	148	0.18	203	0.29
41	50.00	95	1.88	149	0.29	205	0.25
42	75.77	96	0.47	150	0.52	206	0.10
43	52.31	97	0.82	151	1.14	207	0.82
44	3.17	98	0.40	152	0.35	208	0.10
45	1.21	99	0.67	153	0.28	209	0.13
46	0.26	100	2.76	154	0.03	210	0.02
47	3.61	101	1.80	155	1.42	211	0.04
48	0.13	102	0.43	156	0.43	212	0.06
49	0.95	103	0.44	157	0.63	213	1.33
50	0.82	104	0.17	158	0.24	214	0.11
51	8.37	105	0.56	159	0.41	215	0.24
52	0.67	106	1.26	160	0.10	216	0.04
53	3.34	107	0.92	161	0.19	217	0.07
54	0.90	108	0.32	162	0.49	218	0.05
55	32.31	109	1.90	163	3.13	219	0.57
56	4.13	110	0.20	164	0.29	220	0.18
57	43.85	111	0.34	165	0.20	221	1.07
58	2.19	112	0.53	166	0.08	222	0.15
59	2.24	113	9.42	167	0.17	223	0.08
60	0.43	114	0.73	168	0.14	224	0.11
61	0.70	115	0.61	169	1.24	225	1.18
62	0.30	116	0.17	170	0.26	226	0.09
63	1.10	117	0.81	171	0.39	227	0.32
64	0.47	118	0.21	172	0.12	228	0.02
65	4.62	119	3.53	173	0.05	229	0.08
66	2.69	120	0.52	174	0.15	231	0.57
67	40.00	121	0.47	175	2.96	232	0.07
68	2.72	122	0.26	176	0.27	233	0.27
69	11.73	123	0.31	177	0.53	234	0.04
70	0.81	124	0.86	178	0.06	235	0.07
71	1.07	125	1.61	179	0.17	237	0.13
72	0.40	126	0.31	180	0.10	238	0.07
73	2.40	127	1.56	181	2.16	239	0.31
74	0.35	128	0.29	182	0.73	240	0.05
75	5.05	129	0.41	183	0.47	241	0.49
76	0.75	130	0.24	184	0.05	242	0.05
77	2.74	131	7.50	185	0.06	243	1.45
78	0.34	132	0.84	186	0.19	244	0.17
79	0.59	133	0.75	187	0.38	245	0.30
80	0.23	134	0.09	188	0.12	246	0.04
81	0.94	135	0.25	189	0.58	247	0.20
248	0.03	266	0.04	289	0.16	319	20.38
249	0.21	267	0.08	291	1.48	320	2.69
250	0.03	268	0.01	292	0.16	321	0.21
251	1.30	269	0.24	293	0.02	328	0.05
252	0.14	270	0.03	299	0.08	329	0.40
253	1.75	271	4.93	300	0.03	330	0.33
254	0.12	272	0.37	301	0.04	331	0.08
257	0.11	273	0.12	306	17.12	333	0.15
258	0.03	279	0.06	307	4.06	347	0.03
259	0.10	281	0.04	308	0.30	348	0.47
261	0.19	283	0.05	309	0.08	349	0.06
263	1.21	286	0.04	311	0.93		
264	0.08	287	0.12	312	0.11		
265	0.20	288	0.09	313	0.04		

Mass Spectrum 43: 1-(2-Hydro-perfluorocyclohexyl)-cyclohexan-1-ol (116).

CF32 622 (10.368)

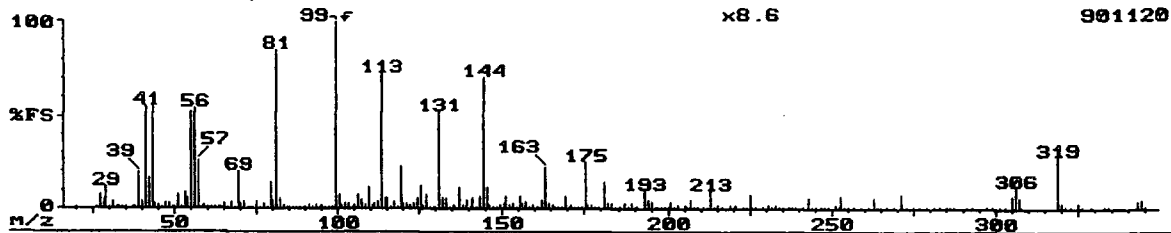

Mass	Rel Int	Mass	Rel Int	Mass	Rel Int	Mass	Rel Int
20	0.02	80	4.60	134	0.16	189	0.33
26	0.62	81	85.91	135	0.18	190	0.03
27	8.18	82	6.31	136	0.12	191	0.13
28	4.74	83	1.99	137	1.38	193	1.09
29	11.93	84	0.48	138	0.26	194	0.55
30	0.34	85	0.44	139	0.56	195	0.48
31	3.69	86	0.17	140	0.16	196	0.15
32	0.47	87	0.70	141	0.63	197	0.06
33	0.43	88	0.48	142	0.15	198	0.04
34	0.41	89	0.99	143	0.74	199	0.13
35	0.32	90	0.27	144	8.30	200	0.13
37	0.19	91	1.78	145	1.40	201	0.50
38	0.68	92	0.14	146	0.21	202	0.07
39	19.43	93	1.57	147	0.16	203	0.21
40	4.35	94	0.92	148	0.10	205	0.21
41	55.45	95	1.58	149	0.24	206	0.10
42	16.82	96	0.43	150	0.39	207	0.53
43	55.00	97	1.11	151	0.77	208	0.07
44	2.93	98	0.68	152	0.18	209	0.11
45	1.81	99	100.00	153	0.29	211	0.06
46	0.22	100	7.84	154	0.05	212	0.06
47	2.76	101	1.55	155	0.80	213	1.12
48	3.32	102	0.39	156	0.34	214	0.15
49	0.68	103	0.32	157	0.40	215	0.25
50	0.75	104	0.13	158	0.16	216	0.06
51	7.95	105	0.26	159	0.22	217	0.04
52	0.99	106	0.88	160	0.07	219	0.25
53	8.75	107	0.52	161	0.16	220	0.07
54	5.80	108	0.24	162	0.53	221	0.22
55	52.73	109	1.40	163	2.59	223	0.06
56	54.55	110	0.20	164	0.30	224	0.06
57	25.80	111	0.32	165	0.26	225	0.92
58	1.40	112	0.50	166	0.09	226	0.07
59	1.90	113	8.52	167	0.09	227	0.11
60	0.25	114	0.65	168	0.11	229	0.04
61	0.89	115	0.63	169	0.75	231	0.19
62	0.22	116	0.11	170	0.16	232	0.06
63	0.70	117	0.45	171	0.19	233	0.21
64	0.29	118	0.14	172	0.06	234	0.05
65	3.30	119	2.73	173	0.07	235	0.16
66	1.18	120	0.35	174	0.12	237	0.12
67	4.06	121	0.34	175	2.90	238	0.05
68	0.75	122	0.21	176	0.23	239	0.14
69	20.11	123	0.31	177	0.23	241	0.10
70	2.95	124	0.65	178	0.04	243	0.70
71	3.89	125	1.48	179	0.07	244	0.16
72	0.45	126	0.25	181	1.68	245	0.17
73	1.15	127	0.89	182	0.29	247	0.07
74	0.27	128	0.13	183	0.36	248	0.02
75	4.23	129	0.17	184	0.07	249	0.04
76	0.52	130	0.15	185	0.07	251	0.24
77	3.01	131	6.14	186	0.11	252	0.03
78	0.63	132	0.70	187	0.34	253	0.75
79	14.32	133	0.73	188	0.12	254	0.05
255	0.09	273	0.07	297	0.03	323	0.03
257	0.17	275	0.12	299	0.03	325	0.30
259	0.09	277	0.08	301	0.07	326	0.04
261	0.05	279	0.05	303	0.08	329	0.07
263	0.70	281	0.04	305	0.77	333	0.08
264	0.05	283	0.09	306	1.40	334	0.04
265	0.17	285	0.11	307	0.65	343	0.42
267	0.10	286	0.04	308	0.06	344	0.58
269	0.04	287	0.04	319	3.32	345	0.12
271	0.87	291	0.03	320	0.35		
272	0.06	293	0.02	321	0.03		

Appendix B.iv.: Mass Spectra for Chapter 5.

Mass Spectrum 44: 1-(1,2,3,3,3-Pentafluoro-E-prop-1-enyl)-cyclohexanol (119).

Mass Spectrum 45: 1-(1,2,3,3,3-Pentafluoro-E-prop-1-enyl)-cyclopentanol (124).

Mass Spectrum 46: 1-(1,1,2,3,3,3-Hexafluoropropyl)-cyclopentyl acetate (126).

Mass Spectrum 47: 1,1,1,2,3,3,7,7,8,9,9,9-Dodecafluoro-4,6-dimethylnonane-4,6-diacetate (127).

Mass Spectrum 48: 1-(1,1,2,3,3,3-Hexafluoropropyl)-cyclopentyl benzoate (129).

Mass Spectrum 49: 1-(1,1,2,3,3,3-Hexafluoropropyl)-cyclopentyl methacrylate (131).

Mass Spectrum 50: 1-(1,2,3,3,3-Pentafluoro-Z-prop-1-enyl)-cyclopentyl acetate (132).

Mass Spectrum 51: (1-(1,1,2,3,3,3-Hexafluoropropyl)-cyclopentoxy)-trimethyl silane (140).

Mass Spectrum 52: 1-(1,1,2,3,3,3-Hexafluoropropyl)-cyclohexene (142).

Mass Spectrum 53: 1-(1,1,2,3,3,3-Hexafluoropropyl)-cyclopentene (143).

Mass Spectrum 54: 1-(1,1,2,3,3,3-Hexafluoropropyl)-cycloheptene (144).

Mass Spectrum 55: 1-(1,1,2,3,3,3-Hexafluoropropyl)-norbornene (145).

Mass Spectrum 56: 1-(2-Hydro-perfluorocyclopentyl)-cyclopentene (146).

Mass Spectrum 57: 1-(2-Hydro-perfluorocyclohexyl)-cyclohexene (147).

Mass Spectrum 58: 1,x-Di-(1,1,2,3,3,3-hexafluoropropyl)-cyclopentadiene (x=3,4) (148).

Mass Spectrum 59: 1-(1,1,2,3,3,3-Hexafluoropropyl)-1,2-dibromocyclohexane (149).

Mass Spectrum 60: 1-(1,1,2,3,3,3-Hexafluoropropyl)-1,2-dibromocyclopentane (150).

Mass Spectrum 61: 1-(1,1,2,3,3,3-Hexafluoropropyl)-5-bromocyclopentene (151).

Mass Spectrum 62: 1-(1,1,2,3,3,3-Hexafluoropropyl)-cyclopentene epoxide (152).

Mass Spectrum 63: 1-(1,1,2,3,3,3-Hexafluoropropyl)-cyclohexene epoxide (153).

Mass Spectrum 64: 1-(1,1,2,3,3,3-Hexafluoropropyl)-cyclohexane-1,2-diol (154).

Mass Spectrum 65: 3,6-Dibromo-(1,1,2,3,3,3-hexafluoropropyl)-cyclohexene (155).

Mass Spectrum 66: (1,1,2,3,3,3-Hexafluoropropyl)-benzene (156).

Mass Spectrum 67: 2-Bromo-(1,1,2,3,3,3-hexafluoropropyl)-benzene (157).

Mass Spectrum 68: 1-(1,2,3,3,3-Pentafluoro-Z-prop-1-enyl)-cyclopentene (159).

Mass Spectrum 69: 1-(1,2,3,3,3-Pentafluoro-Z-prop-1-enyl)-cyclohexene (160).

Mass Spectrum 70: 1-(Perfluorocyclopent-1-enyl)-cyclopentene (161).

Mass Spectrum 71: 1-(Perfluorocyclopent-2-enyl)-cyclopentene.

Mass Spectrum 72: 1-(2,3,3,3-Tetrafluoro-1-methoxy-prop-1-enyl)-cyclopentene (163).

Mass Spectrum 73: 1-(2,3,3,3-Tetrafluoro-1-propoxy-prop-1-enyl)-cyclopentene (164).

Mass Spectrum 74: 1-(2,3,3,3-Tetrafluoro-1-phenylmethoxy-prop-1-enyl)-cyclopentene (165).

Mass Spectrum 75: 1-(1,2,3,3,3-Pentafluoro-E-prop-1-enyl)-cyclohexene epoxide (166).

Mass Spectrum 76: 1-(1,2,3,3,3-Pentafluoro-E-prop-1-enyl epoxide)-cyclohexene epoxide (167).

Mass Spectrum 44: 1-(1,2,3,3,3-Pentafluoro-E-prop-1-enyl)-cyclohexanol (119).

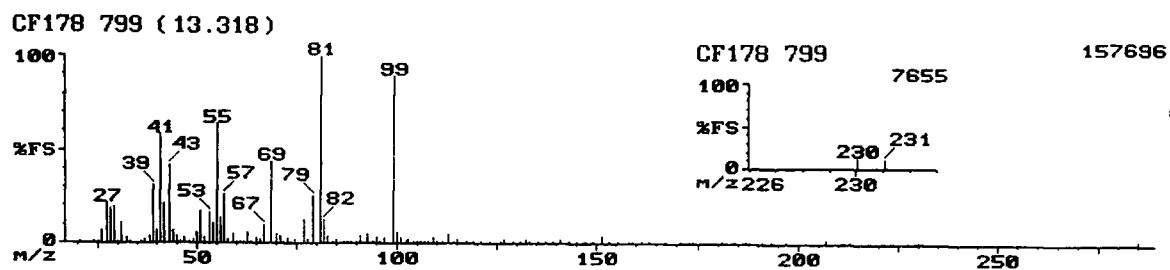

Mass	Rel Int	Mass	Rel Int	Mass	Rel Int	Mass	Rel Int
21	1.18	56	13.47	91	3.57	133	1.07
24	0.44	57	26.30	93	4.91	135	0.24
25	1.21	58	1.83	94	0.70	137	0.25
26	6.66	59	4.67	95	2.60	139	1.27
27	21.75	60	0.55	96	0.87	141	1.55
28	18.83	61	1.35	97	2.68	143	1.03
29	19.64	62	1.10	99	88.96	145	0.74
30	0.74	63	6.17	100	5.56	147	0.44
31	10.71	64	1.27	101	2.53	149	0.30
32	2.76	65	3.25	102	0.23	151	3.53
33	1.26	66	2.35	103	1.64	153	0.47
36	0.34	67	9.66	104	0.23	155	0.43
37	1.77	69	44.16	105	0.37	158	0.37
38	3.53	70	4.67	106	0.92	159	0.68
39	31.49	71	3.41	107	0.88	161	0.45
40	7.06	72	0.47	108	0.91	163	0.92
41	57.79	73	3.00	109	2.64	167	1.45
42	21.75	74	0.80	110	0.29	171	0.54
43	41.40	75	1.89	111	0.70	173	0.98
44	6.82	77	12.34	113	5.15	174	0.59
45	3.69	78	2.06	114	0.54	181	1.00
46	0.56	79	24.84	115	1.82	184	0.31
47	3.33	81	100.00	117	0.31	187	0.49
48	0.40	82	12.50	119	0.79	191	0.39
49	1.59	83	4.06	121	0.64	193	0.43
50	5.44	84	0.60	123	1.25	197	0.19
51	17.69	85	1.69	126	0.54	207	1.50
52	3.29	87	0.61	127	1.80	213	0.61
53	16.56	88	0.27	129	0.97	230	0.66
54	10.31	89	1.44	131	1.31	231	0.47
55	63.64	90	0.34	132	1.49	285	1.48

Mass Spectrum 45: 1-(1,2,3,3,3-Pentafluoro-E-prop-1-enyl)-cyclopentanol (124).

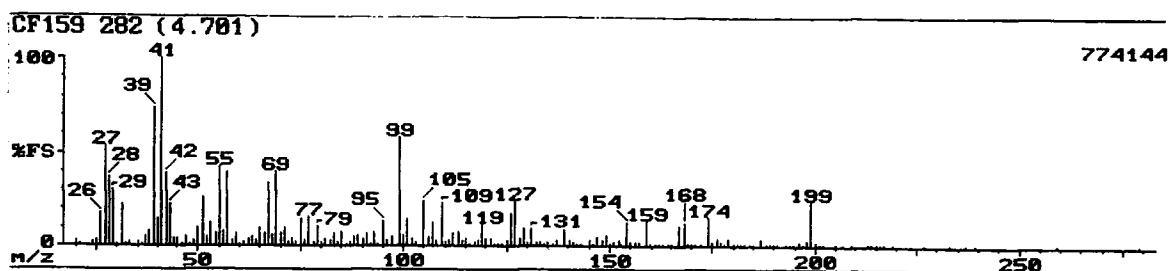

Mass	Rel Int	Mass	Rel Int	Mass	Rel Int	Mass	Rel Int
20	3.11	70	6.75	119	11.51	170	0.25
21	0.09	71	9.92	120	3.70	171	0.35
24	1.55	72	1.60	121	3.87	172	0.19
25	3.08	73	3.47	122	0.90	174	16.01
26	17.33	74	2.28	123	0.52	175	2.31
27	53.44	75	14.68	124	0.61	176	4.03
28	36.51	76	3.24	125	2.91	177	2.28
29	29.76	77	15.74	126	17.06	178	0.60
30	0.91	78	2.18	127	24.47	179	3.77
31	22.75	79	10.98	128	3.80	180	0.47
32	1.02	80	1.56	129	9.92	181	0.50
33	2.06	81	4.37	130	1.77	182	0.12
35	1.54	82	2.58	131	10.19	183	0.40
36	1.25	83	6.48	132	1.83	184	0.06
37	4.76	84	2.25	133	2.38	185	0.08
38	7.90	85	7.57	134	1.08	187	3.67
39	74.07	86	1.20	135	1.75	188	1.23
40	14.55	87	2.41	136	0.61	189	0.08
41	100.00	88	4.76	137	3.11	190	0.03
42	39.15	89	5.89	139	8.60	191	0.05
43	22.62	90	4.27	140	3.21	193	0.08
44	3.97	91	7.11	141	2.10	194	0.10
45	4.20	92	0.17	142	0.13	195	0.35
46	1.41	93	7.94	143	0.44	196	1.61
47	4.56	94	0.93	145	3.04	197	1.42
48	0.61	95	13.36	146	0.74	198	2.58
49	3.04	96	3.08	147	4.73	199	24.47
50	9.39	97	4.86	148	2.45	200	2.00
51	25.93	99	58.20	149	5.79	201	0.23
52	4.56	100	5.46	150	1.09	202	0.04
53	12.30	101	14.29	151	1.85	205	0.04
54	6.32	102	3.57	152	2.74	207	0.08
55	42.33	103	1.84	153	0.74	209	0.05
56	8.10	105	24.47	154	12.17	213	0.04
57	39.68	106	4.40	155	1.95	214	0.10
58	2.55	107	12.70	156	1.70	215	0.23
59	6.45	108	3.31	157	1.58	216	0.07
60	1.18	109	23.54	159	13.49	217	0.06
61	1.73	110	1.69	160	0.42	219	0.14
62	3.67	111	3.11	161	0.98	227	0.04
63	5.03	112	6.75	162	0.07	233	0.03
64	2.68	113	7.51	163	0.85	237	0.04
65	9.39	114	2.74	164	0.19	239	0.04
66	6.98	115	4.17	165	0.43	259	0.02
67	34.39	116	0.60	167	10.98	279	0.05
68	6.08	117	1.98	168	12.30		
69	39.68	118	2.48	169	1.22		

Mass Spectrum 46: 1-(1,1,2,3,3,3-Hexafluoropropyl)-cyclopentyl acetate (126).

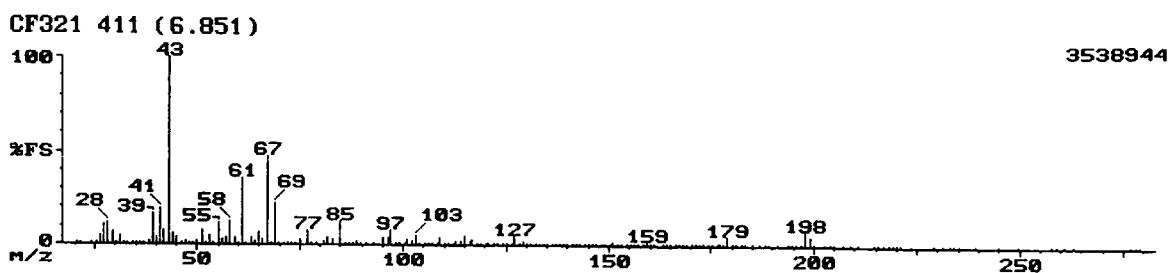

Mass	Rel Int	Mass	Rel Int	Mass	Rel Int	Mass	Rel Int
20	0.62	71	1.41	125	0.15	175	0.04
21	0.03	72	0.32	126	1.24	176	0.24
24	0.37	73	0.72	127	4.66	177	0.64
25	0.95	74	0.33	128	1.05	178	0.30
26	4.51	75	2.49	129	1.88	179	5.24
27	11.11	77	8.22	130	0.28	180	0.37
28	11.57	78	0.75	131	0.46	181	0.05
29	6.74	79	0.88	132	0.49	182	0.01
30	0.35	81	1.70	133	0.56	183	0.02
31	4.95	82	3.41	134	0.12	185	0.01
32	0.96	83	3.18	135	0.28	187	0.12
33	0.72	85	12.38	136	0.06	188	0.01
34	0.02	86	0.64	137	0.22	189	0.02
35	0.25	87	0.24	138	0.19	191	0.03
36	0.23	88	1.07	139	0.36	194	0.02
37	0.98	89	1.77	140	0.07	195	0.06
38	1.97	90	1.39	141	0.11	196	0.09
39	16.44	91	1.25	142	0.04	197	0.48
40	3.47	93	1.14	143	0.04	198	7.52
41	19.10	95	3.99	144	0.11	199	4.69
42	7.99	96	3.73	145	0.45	200	0.23
43	100.00	97	7.99	146	0.13	203	0.03
44	5.84	98	1.09	147	0.17	204	0.01
45	3.76	99	0.81	148	0.06	205	0.01
46	0.31	100	0.81	149	0.09	207	0.15
47	1.61	101	2.46	150	0.48	209	0.02
48	0.13	102	1.91	151	1.78	211	0.02
49	0.31	103	5.06	152	0.11	215	0.03
50	2.26	104	0.29	153	0.20	216	0.14
51	7.99	105	0.16	154	0.06	217	1.32
52	1.18	106	0.23	155	0.17	218	0.77
53	4.60	107	0.44	156	0.07	219	0.21
54	0.69	108	0.98	157	0.17	220	0.04
55	12.04	109	3.56	158	0.56	221	0.01
56	2.52	110	0.43	159	2.08	229	0.01
57	3.96	111	0.26	160	0.21	231	0.01
58	12.27	112	0.63	161	0.07	233	0.02
59	3.53	113	2.14	163	0.07	234	0.01
60	0.77	114	2.03	164	0.02	235	0.30
61	36.11	115	4.63	165	0.05	239	0.01
62	1.45	116	1.88	167	0.04	245	0.02
63	3.53	117	2.98	167	0.17	250	0.05
64	1.55	118	0.34	168	0.02	258	0.03
65	6.57	119	0.43	169	0.05	259	0.03
66	3.36	120	0.16	170	0.04	261	0.01
67	47.69	121	0.48	171	0.10	263	0.25
68	1.35	122	0.10	172	0.06	277	0.10
69	21.88	123	0.05	173	0.10	278	0.20
70	0.96	124	0.06	174	0.04	279	0.28

Mass Spectrum 47: 1,1,1,2,3,3,7,7,8,9,9,9-Dodecafluoro-4,6-dimethylnonane-4,6-diacetate (127).

CF325 699 (11.651)

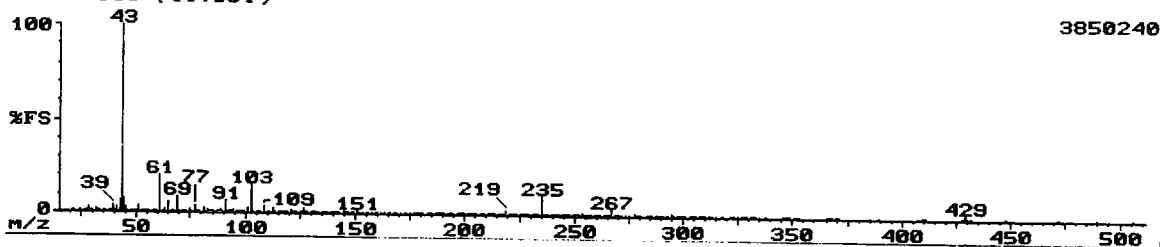

3850240

Mass	Rel Int	Mass	Rel Int	Mass	Rel Int	Mass	Rel Int
20	0.52	83	1.46	140	0.12	200	0.09
21	0.02	84	0.42	141	0.32	201	0.14
24	0.10	85	1.02	142	0.18	202	0.03
25	0.26	86	0.10	143	0.07	203	0.27
26	0.59	87	0.26	145	1.89	204	0.04
27	0.95	88	0.68	146	0.33	205	0.08
28	2.58	89	1.51	147	0.55	206	0.01
29	1.18	90	0.92	148	0.12	207	0.19
30	0.19	91	6.91	149	0.18	208	0.07
31	1.68	92	0.33	151	2.42	209	0.41
32	0.41	93	1.01	152	0.16	210	0.05
33	0.34	94	0.32	153	0.30	211	0.04
35	0.13	95	1.86	155	0.59	212	0.03
36	0.15	96	0.72	155	0.31	213	0.10
37	0.34	97	1.28	156	0.06	214	0.07
38	0.72	98	0.27	157	0.11	215	0.96
39	3.86	99	0.43	159	0.90	216	0.07
40	1.22	100	0.28	159	0.39	217	0.81
41	3.03	101	2.55	160	0.13	218	0.09
42	7.13	103	15.64	161	0.04	219	2.47
43	100.00	104	0.89	163	0.39	220	0.19
44	7.55	105	0.46	165	0.57	221	0.12
45	2.58	106	0.18	166	0.29	222	0.02
46	0.27	107	0.43	167	0.49	223	0.12
47	1.00	109	3.40	168	0.05	224	0.02
48	0.06	110	0.27	169	0.16	225	0.04
49	0.13	111	0.17	171	0.59	226	0.01
50	0.90	113	2.71	172	0.12	227	0.64
51	3.99	114	0.76	173	0.33	228	0.13
52	0.32	115	1.44	175	0.19	229	0.13
53	0.58	116	0.50	175	0.20	230	0.02
54	0.20	117	0.60	177	0.41	231	0.06
55	0.34	118	0.41	177	0.56	232	0.02
56	0.29	119	0.49	178	0.16	233	0.17
57	1.18	120	0.06	179	0.28	234	0.38
58	0.68	121	2.34	180	0.06	235	10.85
59	1.43	122	0.24	181	0.10	236	0.94
61	20.11	123	0.14	183	0.27	237	0.28
62	0.66	124	0.03	184	0.02	238	0.02
63	1.63	125	0.25	185	0.29	239	0.12
65	6.14	126	0.09	186	0.06	240	0.04
66	0.51	127	2.61	187	0.18	241	0.09
67	0.48	128	0.39	188	0.04	242	0.01
69	8.30	129	0.47	189	0.19	243	0.02
70	0.28	130	0.06	190	0.02	244	0.02
71	0.54	131	0.61	191	0.42	245	0.19
72	0.18	132	0.60	192	0.16	246	0.02
73	0.21	133	1.00	193	0.06	247	0.82
75	1.91	134	0.13	194	0.03	248	0.15
76	0.08	135	0.31	195	0.69	249	0.31
77	3.56	136	0.04	196	0.12	250	0.06
78	0.37	137	0.26	197	0.43	251	0.27
79	0.28	138	0.06	198	0.12	252	0.02
82	3.22	139	0.48	199	0.21	253	2.23

Mass	Rel Int	Mass	Rel Int	Mass	Rel Int	Mass	Rel Int
254	0.21	284	0.02	313	0.01	353	0.00
255	0.04	285	0.07	315	0.01	365	0.01
256	0.01	286	0.01	317	0.02	366	0.01
257	0.04	287	0.04	318	0.01	367	0.04
258	0.01	288	0.02	321	0.01	368	1.14
259	0.15	289	0.09	322	0.01	369	1.06
260	0.03	290	0.04	323	0.02	370	0.11
261	0.05	291	0.03	325	0.04	371	0.01
262	0.01	292	0.01	326	0.01	385	0.01
263	0.03	293	0.01	327	0.17	389	0.02
264	0.02	295	1.70	328	0.04	407	0.04
265	0.17	296	0.20	329	0.38	409	0.25
266	0.16	297	0.04	330	0.06	410	0.03
267	4.15	298	0.01	331	0.04	411	0.01
268	0.48	299	0.04	332	0.01	427	0.03
269	0.03	300	0.01	333	0.01	428	0.59
270	0.03	301	0.01	335	0.01	429	2.77
271	0.04	303	0.04	337	0.07	430	0.33
272	0.01	304	0.02	338	0.01	431	0.04
273	0.01	305	0.02	345	0.04	447	0.05
275	0.02	306	0.01	346	0.03	448	0.01
277	1.51	307	0.04	347	0.08	471	0.04
278	0.16	308	0.10	348	0.05	472	0.01
279	0.13	309	0.10	349	0.70	489	0.01
280	0.02	310	0.04	350	0.14	506	0.02
281	0.03	311	0.03	351	0.04		
283	0.04	312	0.01	352	0.01		

Mass Spectrum 48: 1-(1,1,2,3,3,3-Hexafluoropropyl)-cyclopentyl benzoate (129).

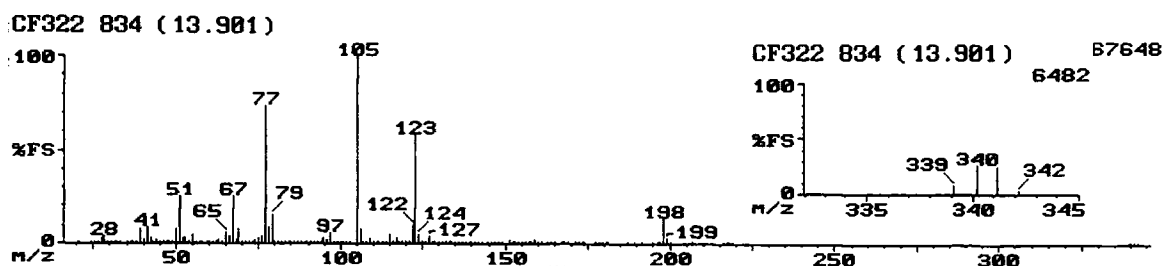

Mass	Rel Int	Mass	Rel Int	Mass	Rel Int	Mass	Rel Int
20	0.05	66	3.83	109	2.76	153	0.29
24	0.12	67	25.15	110	0.34	154	0.16
25	0.29	68	1.93	111	0.18	155	0.37
26	1.37	69	7.90	112	0.18	156	0.09
27	2.95	70	0.62	113	1.33	157	0.17
28	4.10	71	0.58	114	0.92	158	0.10
29	1.15	72	0.18	115	4.87	159	1.50
30	0.04	73	0.65	116	1.40	160	0.17
31	1.04	74	1.68	117	3.26	161	0.09
32	0.45	75	2.68	118	0.40	163	0.18
33	0.23	76	4.18	119	0.38	164	0.06
35	0.23	77	74.23	120	0.35	165	0.07
36	0.30	78	8.59	121	0.85	167	0.18
37	0.78	79	15.49	122	10.12	168	0.04
38	1.31	80	1.10	123	58.28	169	0.04
39	7.40	81	0.44	124	4.49	171	0.08
40	1.60	82	1.38	125	0.54	172	0.04
41	8.28	83	1.26	126	0.10	173	0.09
42	2.72	84	0.88	127	3.49	174	0.02
43	0.88	85	0.63	128	0.75	177	0.87
44	2.02	86	0.12	129	1.44	178	1.04
45	0.90	87	0.15	130	0.20	179	0.67
46	0.15	88	0.64	131	0.39	180	0.07
47	0.97	89	1.08	132	0.33	181	0.07
48	0.29	90	0.74	133	0.70	187	0.07
49	0.67	91	1.01	134	0.11	189	0.07
50	7.29	92	0.19	135	0.29	191	0.04
51	25.31	93	0.73	136	0.04	195	0.05
52	3.11	94	0.81	137	0.14	196	0.06
53	2.95	95	2.68	138	0.06	197	0.54
54	0.63	96	1.79	139	0.39	198	13.34
55	5.06	97	5.67	140	0.11	199	2.65
56	1.20	98	0.81	141	0.17	200	0.29
57	0.67	99	0.53	142	0.04	207	0.09
58	0.22	100	0.18	143	0.07	216	0.23
59	0.70	101	1.35	145	0.59	217	0.52
60	0.23	102	0.33	146	0.21	218	0.69
61	0.35	103	0.97	147	0.25	219	0.09
62	0.72	105	100.00	148	0.08	339	0.08
63	2.37	106	7.67	149	0.07	340	0.25
64	1.02	107	0.86	151	1.71	341	0.24
65	5.67	108	0.23	152	0.11	342	0.04

Mass Spectrum 49: 1-(1,1,2,3,3,3-Hexafluoropropyl)-cyclopentyl methacrylate (131).

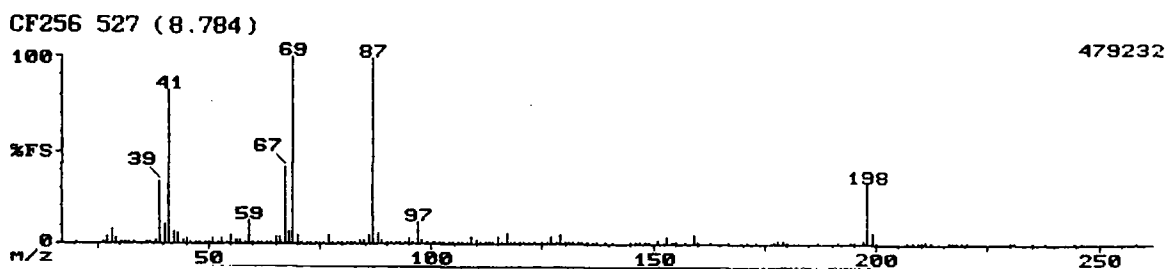

Mass	Rel Int	Mass	Rel Int	Mass	Rel Int	Mass	Rel Int
20	0.03	67	41.67	107	0.38	155	0.60
26	0.76	68	6.57	108	0.19	157	0.16
27	4.22	69	100.00	109	3.42	159	4.81
28	7.43	70	4.86	110	2.35	160	0.38
29	2.75	71	1.00	111	0.96	163	0.08
30	0.14	72	0.13	112	0.10	167	0.23
31	0.77	73	0.92	113	1.01	171	0.21
32	1.28	74	0.81	114	0.47	173	0.27
33	0.26	75	0.64	115	3.90	177	1.14
36	0.19	76	0.61	116	1.01	178	1.76
37	0.58	77	5.07	117	6.09	179	1.75
38	1.71	78	0.54	118	0.50	180	0.15
39	34.19	79	0.40	119	0.37	187	0.12
40	10.90	80	0.13	120	0.64	191	0.23
41	82.91	81	0.33	121	0.57	194	0.15
42	6.41	82	1.01	122	0.28	195	0.05
43	6.14	83	1.34	123	0.08	197	1.71
44	1.88	84	2.32	125	0.37	198	32.91
45	3.22	85	1.67	126	0.13	199	7.21
46	0.18	86	4.65	127	4.06	200	0.51
47	1.39	87	99.15	128	0.69	207	0.37
48	0.08	88	5.56	129	4.65	208	0.08
49	0.09	89	1.59	130	0.46	209	0.04
50	0.39	90	0.73	131	0.31	210	0.91
51	2.94	91	0.85	132	0.14	211	1.56
52	0.56	92	0.06	133	0.88	212	0.11
53	2.84	93	0.38	134	0.11	216	0.07
54	0.83	94	0.11	135	0.85	217	1.19
55	5.29	95	2.70	136	0.07	218	1.24
56	1.63	96	1.19	137	0.11	219	0.18
57	1.67	97	11.70	139	0.53	220	0.06
58	0.57	98	1.96	141	0.16	230	0.02
59	12.45	99	0.64	145	0.60	231	0.51
60	0.65	100	0.07	146	0.56	235	0.09
61	0.24	101	1.04	147	0.24	238	0.20
62	0.18	102	0.24	148	0.21	244	0.05
63	0.83	103	0.81	149	0.10	246	0.06
64	0.64	104	0.12	151	2.14	258	0.05
65	4.01	105	0.24	153	4.06		
66	3.58	106	0.09	154	0.36		

Mass Spectrum 50: 1-(1,2,3,3,3-Pentafluoro-Z-prop-1-enyl)-cyclopentyl acetate
(132).

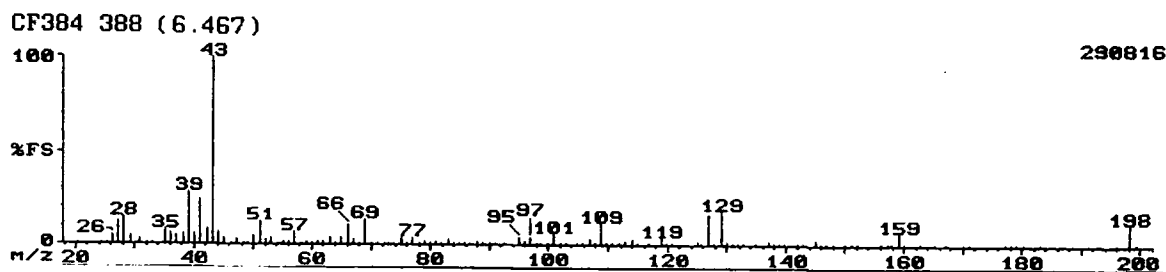

Mass	Rel Int	Mass	Rel Int	Mass	Rel Int	Mass	Rel Int
20	0.47	58	1.00	93	0.63	135	0.12
24	0.30	59	2.35	95	3.90	137	1.52
25	0.62	60	0.82	96	1.61	138	0.40
26	5.15	61	2.00	97	3.79	139	1.15
27	12.76	62	1.61	98	0.59	140	0.17
28	14.70	63	3.41	99	1.45	142	0.14
29	4.84	64	0.97	100	0.35	143	0.25
30	0.10	65	3.59	101	5.35	145	2.86
31	2.99	66	10.39	102	1.40	146	0.22
32	0.46	67	2.84	103	0.33	147	0.69
33	0.84	68	1.20	105	0.24	148	0.18
35	7.75	69	13.56	106	0.96	150	0.43
36	6.07	70	1.43	107	3.28	151	1.07
37	4.78	71	0.76	108	0.86	152	0.16
38	5.72	72	0.12	109	11.71	156	0.50
39	28.52	73	0.37	110	0.70	157	0.59
40	5.90	74	0.73	111	0.19	158	0.26
41	24.30	75	4.07	112	0.47	159	6.51
42	8.89	76	0.45	113	2.07	160	0.38
43	100.00	77	4.09	114	2.55	163	0.69
44	6.51	78	1.01	115	1.28	165	0.81
45	4.27	79	1.72	117	0.23	167	0.15
46	0.40	80	0.32	119	3.76	170	0.27
47	2.49	81	2.09	120	0.81	171	0.15
48	0.33	82	0.65	121	0.60	177	1.12
49	1.36	83	2.57	125	1.47	178	0.90
50	5.15	84	0.85	126	0.57	179	0.95
51	12.50	85	0.56	127	16.29	180	0.19
52	2.44	86	0.22	128	1.45	183	0.63
53	3.83	87	0.34	129	18.40	196	0.45
54	0.73	88	1.54	130	1.50	198	11.44
55	2.05	89	1.39	131	0.93	199	1.29
56	1.50	90	0.32	132	1.01		
57	6.78	91	0.42	133	0.56		

Mass Spectrum 51: (1-(1,1,2,3,3,3-Hexafluoropropyl)-cyclopentoxy)-trimethyl silane
(140).

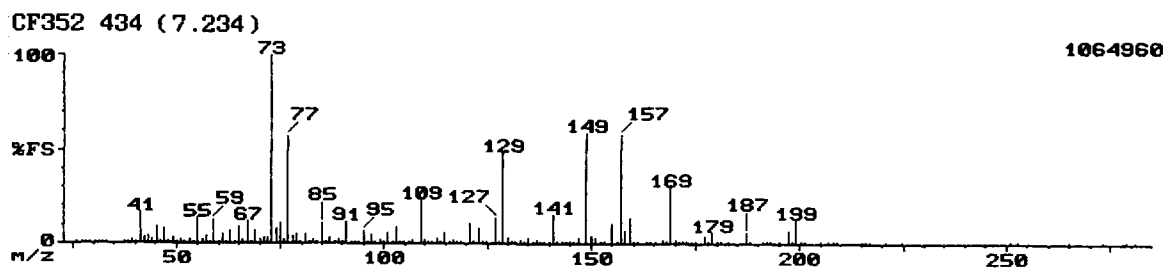

Mass	Rel Int	Mass	Rel Int	Mass	Rel Int	Mass	Rel Int
26	0.13	72	3.32	116	0.58	164	0.15
27	0.89	73	100.00	117	1.83	165	0.05
28	1.11	74	8.17	118	0.20	167	1.71
29	1.21	75	10.48	119	0.96	168	0.25
30	0.06	76	2.00	121	10.77	169	30.00
31	0.25	77	57.31	122	0.58	170	1.83
32	0.15	78	4.11	123	7.60	171	0.26
33	0.07	79	4.54	124	0.38	172	0.12
37	0.02	80	0.55	125	0.70	173	0.17
38	0.09	81	4.47	127	13.75	174	0.16
39	2.21	82	1.24	128	0.82	175	0.19
40	0.56	83	2.36	129	48.08	177	3.68
41	16.83	84	0.61	130	2.55	178	0.27
42	2.45	85	10.29	131	1.08	179	6.25
43	3.82	86	0.68	132	0.41	180	0.44
44	1.88	87	2.52	133	1.56	181	0.37
45	9.04	88	0.43	134	0.18	183	0.06
46	0.69	89	1.75	135	3.32	187	5.72
47	7.50	90	0.52	136	0.21	188	0.71
48	0.32	91	11.54	137	1.75	191	0.55
49	2.86	92	0.76	138	0.15	192	0.14
50	0.37	93	0.74	139	1.30	193	0.05
51	1.75	94	0.31	140	0.20	195	0.31
52	0.30	95	6.54	141	15.19	197	6.35
53	1.90	96	1.10	142	0.70	198	0.46
54	0.48	97	4.54	143	1.31	199	13.08
55	13.94	98	1.38	144	0.08	200	0.93
56	2.14	99	1.68	145	0.59	201	0.25
57	3.80	100	0.19	146	0.42	205	0.09
58	1.41	101	5.58	147	3.15	207	0.68
59	12.21	102	0.38	149	58.85	208	0.03
60	1.14	103	8.56	150	3.89	209	0.03
61	4.54	104	0.49	151	2.60	215	0.05
62	0.92	105	1.30	152	0.12	216	0.06
63	6.35	106	0.15	153	0.77	217	0.22
64	0.75	107	1.53	155	11.06	221	0.06
65	8.65	109	22.98	156	0.76	225	1.13
66	1.59	110	1.78	157	58.46	251	0.34
67	12.12	111	1.13	158	6.83	253	0.11
68	1.19	112	0.17	159	13.75	265	0.43
69	6.83	113	3.13	160	1.36	273	0.06
70	1.56	114	0.53	161	0.53	279	0.57
71	3.10	115	6.03	163	0.41	281	0.05

Mass Spectrum 52: 1-(1,1,2,3,3,3-Hexafluoropropyl)-cyclohexene (142).

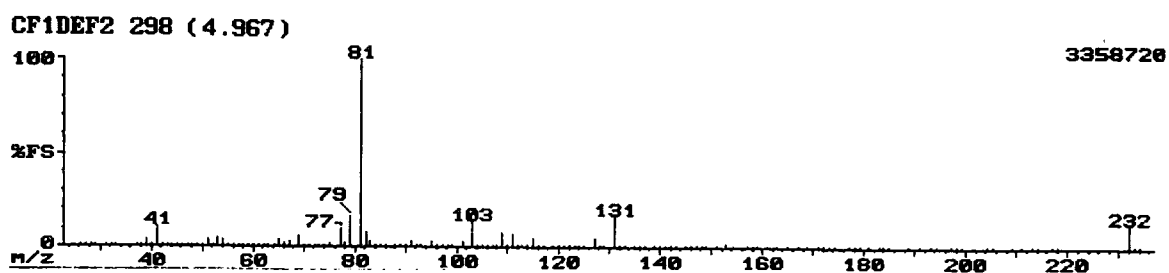

Mass	Rel Int	Mass	Rel Int	Mass	Rel Int	Mass	Rel Int
26	0.09	67	2.84	111	7.10	158	0.27
27	0.68	69	6.04	112	0.73	159	0.17
28	0.23	70	0.44	113	0.95	161	0.03
29	0.20	71	0.57	114	1.37	163	0.20
31	0.10	72	0.19	115	5.34	165	0.24
32	0.05	73	0.32	116	0.83	167	0.34
33	0.08	74	0.30	117	0.11	169	0.13
37	0.06	75	2.20	119	0.46	171	0.42
38	0.30	77	9.76	120	0.16	172	0.20
39	3.93	78	1.86	121	0.88	173	0.84
40	0.50	79	16.10	122	0.28	174	0.07
41	10.85	81	100.00	123	0.73	177	0.66
42	0.47	82	7.80	124	0.12	178	0.05
43	0.05	83	3.35	125	0.21	179	0.03
44	0.05	84	0.58	127	5.24	181	0.03
45	0.08	85	1.42	128	0.56	183	0.06
46	0.07	86	0.19	129	1.27	184	0.05
47	0.76	88	0.82	131	16.95	185	0.13
48	0.02	89	1.07	132	1.16	189	0.14
49	0.05	90	0.65	133	0.97	191	0.27
50	1.06	91	2.59	135	1.37	193	0.72
51	4.36	92	0.29	136	0.07	194	0.06
52	1.33	93	0.28	137	0.11	197	0.57
53	5.15	95	2.80	139	0.50	198	0.04
54	3.57	96	1.28	140	0.61	199	0.01
55	0.95	97	1.34	141	0.82	204	0.63
56	0.12	98	0.26	142	0.14	205	0.04
57	1.12	99	0.47	143	0.28	209	0.02
58	0.13	101	2.93	145	1.16	211	0.09
59	1.33	103	13.66	146	0.07	213	0.92
60	0.10	104	0.65	147	0.63	214	0.06
61	0.14	105	0.07	148	0.05	217	1.07
62	0.26	106	0.10	149	0.08	218	0.07
63	1.20	107	0.39	151	0.93	232	12.93
64	0.52	108	0.39	153	1.78	233	0.94
65	3.87	109	7.35	154	0.11	234	0.04
66	1.54	110	0.73	157	0.15		

Mass Spectrum 53: 1-(1,1,2,3,3,3-Hexafluoropropyl)-cyclopentene (143).

CF17 184 (3.867)

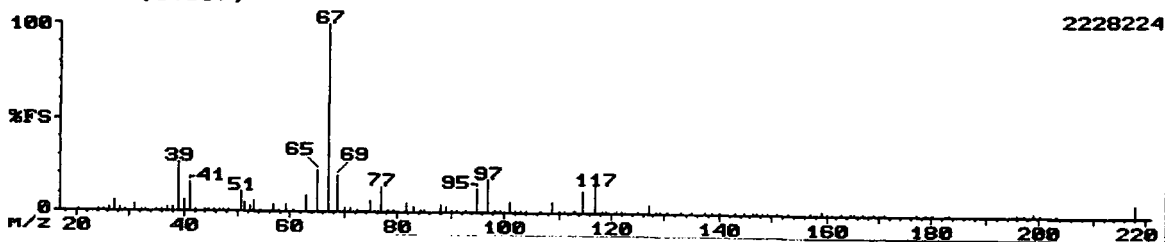

Mass	Rel Int	Mass	Rel Int	Mass	Rel Int	Mass	Rel Int
20	0.48	54	0.22	99	0.46	145	0.83
24	0.49	57	4.23	101	6.07	146	0.08
25	0.71	58	0.14	102	0.85	147	0.14
26	2.40	59	3.68	103	0.55	148	0.03
27	6.25	60	0.32	104	0.06	149	0.04
28	2.36	63	8.55	107	0.95	151	0.49
29	0.55	65	22.79	109	5.74	153	0.13
31	3.58	67	100.00	110	0.49	157	0.10
32	0.82	69	19.30	111	0.21	159	1.77
33	0.70	70	1.79	113	1.36	160	0.13
35	0.48	71	1.57	113	0.79	163	0.15
36	0.21	72	0.22	115	12.13	164	0.02
37	1.91	75	5.84	117	14.15	165	0.05
38	1.67	77	13.97	118	0.80	167	0.03
39	25.92	78	1.40	119	0.69	169	0.04
40	5.47	79	1.15	121	0.45	171	0.07
41	15.63	82	4.92	122	0.02	177	0.57
42	0.80	83	2.81	125	0.25	179	0.66
44	0.88	84	0.84	127	5.15	180	0.06
45	0.83	85	0.59	128	0.36	183	0.03
46	0.35	88	3.72	129	0.53	196	0.02
47	0.58	89	2.85	130	0.11	197	0.33
47	0.52	90	1.16	133	0.57	199	2.27
48	0.14	91	0.75	135	0.13	200	0.12
51	10.62	93	0.79	137	0.13	203	0.04
51	5.33	95	12.87	139	0.56	218	6.99
52	3.08	97	17.83	140	0.06		
53	5.38	98	1.23	143	0.03		

Mass Spectrum 54: 1-(1,1,2,3,3,3-Hexafluoropropyl)-cycloheptene (144).

CFCYC7 363 (6.051)

3457024

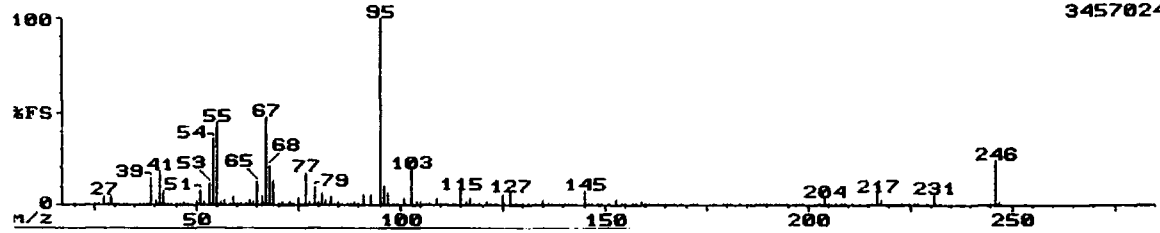

Mass	Rel Int	Mass	Rel Int	Mass	Rel Int	Mass	Rel Int
20	0.02	68	21.21	117	4.21	177	1.07
25	0.02	69	13.15	118	0.32	179	0.65
26	0.43	70	1.42	119	0.56	180	0.04
27	5.15	71	1.54	121	1.77	181	0.26
28	1.38	72	0.65	122	0.42	183	0.16
29	4.41	73	1.55	123	1.39	185	0.87
30	0.10	74	0.30	125	6.04	186	0.21
31	0.27	75	3.52	127	6.40	187	0.50
32	0.16	76	0.46	128	0.81	188	0.02
33	0.32	77	17.06	129	1.28	189	0.26
36	0.02	78	2.25	130	0.35	190	0.04
37	0.18	79	9.72	131	0.18	191	0.56
38	0.94	80	2.34	133	1.41	192	0.05
39	14.93	81	6.87	135	2.78	193	0.03
40	3.11	82	2.43	136	0.21	195	0.04
41	18.36	83	5.30	137	0.35	197	1.17
42	8.06	84	1.17	139	0.98	198	0.26
43	0.90	85	2.34	140	1.01	199	0.29
44	0.13	86	0.26	141	1.43	203	0.14
45	0.21	87	0.40	142	0.20	204	4.30
46	0.21	88	1.33	143	0.40	205	0.58
47	2.19	89	2.01	145	7.52	207	0.81
48	0.06	90	0.84	146	0.62	208	0.08
49	0.07	91	6.04	147	0.59	209	0.08
50	1.49	93	5.63	148	0.08	211	0.59
51	8.18	95	100.00	149	0.14	213	0.05
52	2.16	96	10.78	151	0.98	216	0.17
53	11.73	97	7.23	153	2.43	217	7.26
54	36.02	98	0.67	154	0.18	218	2.52
55	44.55	99	0.99	155	0.14	223	0.03
56	2.34	101	3.50	157	0.43	225	0.10
57	2.64	103	19.43	158	0.26	226	0.34
58	0.35	104	1.50	159	2.04	227	0.56
59	5.12	105	1.70	160	0.13	229	0.03
60	0.67	106	0.31	161	0.20	231	5.86
61	1.38	107	0.41	163	0.29	232	0.44
62	0.84	109	4.24	165	0.73	245	0.91
63	3.32	110	0.74	167	0.64	246	23.82
64	2.25	111	0.40	169	0.13	247	2.01
65	12.44	113	1.40	171	0.63	281	0.02
66	4.71	115	8.18	172	0.15		
67	47.39	116	1.61	173	0.11		

Mass Spectrum 55: 1-(1,1,2,3,3,3-Hexafluoropropyl)-norbornene (145).

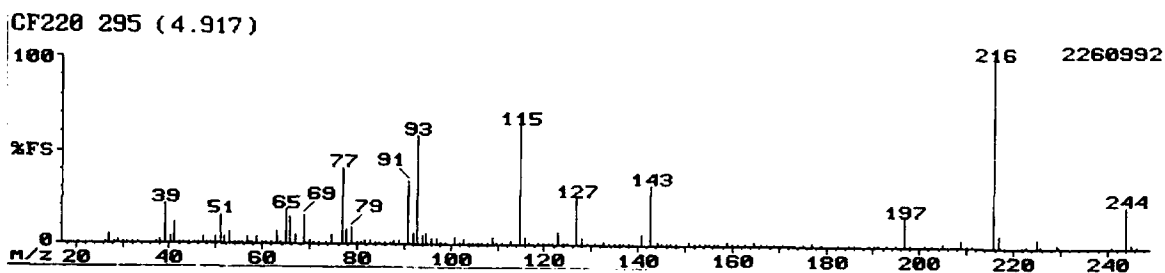

Mass	Rel Int	Mass	Rel Int	Mass	Rel Int	Mass	Rel Int
20	0.02	67	5.12	111	0.15	161	0.09
26	0.50	69	15.94	113	1.51	163	0.49
27	4.80	70	1.72	115	64.49	165	1.52
28	1.09	71	0.86	116	3.94	166	0.12
29	1.54	72	0.38	117	0.21	167	0.02
30	0.02	73	0.37	119	0.80	169	0.60
31	0.48	75	4.71	120	0.37	171	0.14
32	0.14	77	40.58	121	0.96	173	0.14
33	0.41	78	7.70	122	0.78	175	0.24
37	0.43	79	9.15	123	6.43	177	1.68
38	2.05	80	0.70	124	1.15	179	0.56
39	21.56	81	0.84	125	0.39	183	0.44
40	3.62	82	2.30	127	25.00	185	0.65
41	11.96	83	2.42	128	3.62	186	0.05
42	0.82	84	0.56	129	0.41	189	0.42
43	0.25	85	0.47	131	0.26	190	0.08
44	0.18	86	0.22	133	1.86	191	0.03
45	0.21	87	0.38	134	0.44	193	0.03
46	0.22	88	1.62	135	0.49	195	0.12
47	3.80	89	2.00	136	0.14	197	15.40
48	0.04	91	34.24	137	0.20	198	0.93
49	0.10	92	6.02	138	0.17	201	0.06
50	3.58	93	57.97	139	0.61	203	0.15
51	15.94	94	4.76	141	6.16	205	1.75
52	3.85	95	6.11	143	31.70	209	3.71
53	6.88	96	2.62	144	2.38	210	0.26
54	1.11	97	3.17	145	1.44	211	0.26
55	0.56	98	0.29	146	0.22	216	100.00
56	0.12	99	0.55	147	0.33	217	6.39
57	3.49	101	4.30	148	0.03	223	0.25
58	0.11	102	0.68	151	1.97	225	5.25
59	4.03	103	3.40	152	0.14	226	0.18
60	0.31	104	0.39	153	0.57	229	2.07
61	0.34	105	0.32	154	0.29	230	0.12
62	1.08	106	0.11	155	0.43	241	0.09
63	6.39	107	0.72	156	0.20	244	22.64
64	1.23	108	0.30	157	0.23	245	1.72
65	18.12	109	3.76	159	1.65	246	0.08
66	14.86	110	0.49	160	0.15		

Mass Spectrum 56: 1-(2-Hydro-perfluorocyclopentyl)-cyclopentene (146).

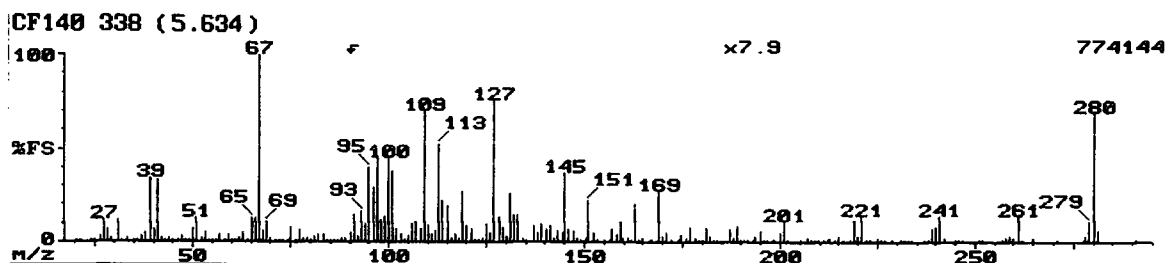

Mass	Rel Int	Mass	Rel Int	Mass	Rel Int	Mass	Rel Int
20	0.93	78	2.00	132	1.84	193	0.16
21	0.06	79	2.31	133	1.79	194	0.31
24	0.64	80	0.65	134	0.20	195	0.74
25	1.01	81	2.68	135	0.07	196	0.13
26	3.37	82	3.70	137	1.05	197	0.15
27	12.04	83	3.87	138	0.67	198	0.06
28	7.14	84	1.10	139	1.28	199	0.13
29	2.12	85	0.93	140	0.88	200	0.65
31	11.77	86	0.30	141	1.14	201	1.33
32	1.36	87	0.63	142	0.20	202	0.13
33	1.60	88	1.47	143	0.74	205	0.16
35	0.47	89	1.52	144	0.64	207	0.30
36	0.44	90	0.67	145	4.66	208	0.11
37	2.45	91	1.87	146	0.87	209	0.14
38	4.63	92	0.38	147	0.69	210	0.04
39	33.86	93	2.11	148	0.25	211	0.06
40	6.55	94	1.17	149	0.11	212	0.10
41	32.80	95	5.06	150	0.26	213	0.20
42	2.41	96	3.67	151	2.81	214	0.10
43	0.34	97	5.59	152	0.59	215	0.33
44	2.12	98	1.45	153	0.12	216	0.04
45	0.75	99	1.72	155	0.16	218	0.18
46	0.21	100	5.62	156	0.14	219	1.42
47	3.34	101	4.83	157	0.90	220	0.43
48	0.14	102	0.92	158	0.44	221	1.70
49	0.60	103	0.48	159	1.37	222	0.18
50	6.81	104	0.14	160	0.24	223	0.06
51	12.57	105	0.42	161	0.30	225	0.23
52	2.31	106	1.27	162	0.14	226	0.08
53	4.40	107	1.36	163	2.55	227	0.06
54	0.48	108	0.91	164	0.17	229	0.09
55	0.53	109	8.86	165	0.24	231	0.12
56	1.28	110	1.09	167	0.08	232	0.05
57	4.37	111	0.43	169	3.44	233	0.09
58	0.38	112	0.70	170	0.42	234	0.04
59	3.97	113	6.65	171	0.65	237	0.08
60	0.42	114	2.88	172	0.15	238	0.10
61	0.80	115	2.41	174	0.16	239	0.83
62	2.10	116	0.29	175	0.55	240	0.97
63	4.96	117	0.44	176	0.24	241	1.77
64	1.42	118	0.28	177	1.00	242	0.26
65	12.43	119	3.47	178	0.19	245	0.09
66	12.30	120	1.06	179	0.16	246	0.04
67	100.00	121	0.85	180	0.13	247	0.08
68	6.28	122	0.14	181	0.96	251	0.07
69	10.98	123	0.14	182	0.40	252	0.07
70	2.10	124	0.26	183	0.14	257	0.08
71	1.03	125	1.27	184	0.05	258	0.23
72	0.42	126	0.59	187	0.82	259	0.36
73	0.35	127	9.52	188	0.29	260	0.28
74	0.56	128	1.74	189	1.12	261	1.71
75	7.90	129	0.99	190	0.16	262	0.17
76	0.89	130	0.34	191	0.11	265	0.20
77	7.18	131	3.34	192	0.03	271	0.04
278	0.33	280	8.73	291	0.04		
279	1.39	281	0.73				

Mass Spectrum 57: 1-(2-Hydro-perfluorocyclohexyl)-cyclohexene (147).

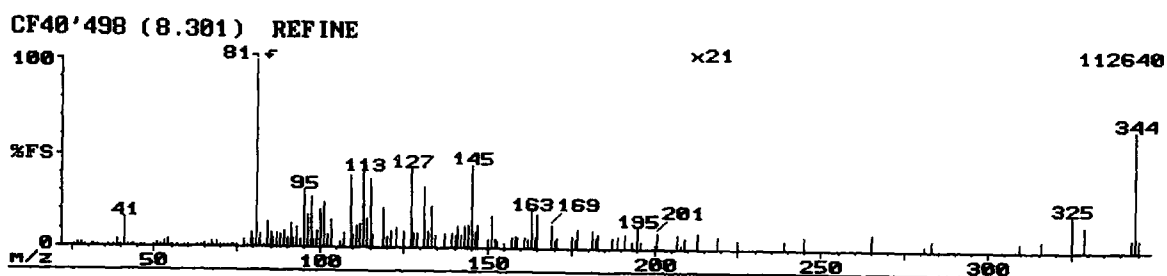

Mass	Rel Int	Mass	Rel Int	Mass	Rel Int	Mass	Rel Int
26	0.23	74	0.25	115	1.79	169	0.61
27	2.02	75	1.07	116	0.31	170	0.22
28	1.52	77	3.45	119	1.02	171	0.27
29	1.19	78	1.09	120	0.30	175	0.32
31	0.23	79	8.01	121	0.43	176	0.23
32	0.15	80	3.98	123	0.50	177	0.50
33	0.28	81	100.00	125	0.42	181	0.45
36	0.09	82	6.93	127	2.09	182	0.28
38	0.37	83	0.94	128	0.40	183	0.37
39	4.26	84	0.65	129	0.38	187	0.29
40	0.63	85	0.39	131	1.62	189	0.33
41	15.68	86	0.24	132	0.42	191	0.36
42	0.83	87	0.37	133	1.07	193	0.19
43	0.27	88	0.35	134	0.35	195	0.57
44	0.29	89	0.44	137	0.36	196	0.18
46	0.18	90	0.25	139	0.39	200	0.09
47	1.14	91	0.63	140	0.32	201	0.44
50	0.50	92	0.25	141	0.57	207	0.38
51	2.34	93	0.51	142	0.33	208	0.10
52	0.74	94	0.21	143	0.54	209	0.26
53	2.94	95	1.51	144	0.62	213	0.44
54	3.45	96	0.84	145	2.14	219	0.31
55	0.92	97	1.32	146	0.45	225	0.25
57	0.58	98	0.18	147	0.63	239	0.23
59	1.16	99	0.44	150	0.24	245	0.34
60	0.15	100	0.98	151	0.85	265	0.40
63	0.53	101	1.18	152	0.23	281	0.15
64	0.27	102	0.32	153	0.19	283	0.28
65	2.17	103	0.71	155	0.14	309	0.22
66	1.36	106	0.16	157	0.26	316	0.28
67	2.78	107	0.36	158	0.32	325	0.92
68	0.28	109	1.88	159	0.30	329	0.68
69	2.44	110	0.33	161	0.28	343	0.34
70	0.40	111	0.57	162	0.23	344	3.17
71	0.26	112	0.60	163	0.98	345	0.34
72	0.16	113	1.97	164	0.29		
73	0.33	114	0.77	165	0.89		

Mass Spectrum 58: 1,x-Di-(1,1,2,3,3,3-hexafluoropropyl)-cyclopentadiene (x=3,4)
(148).

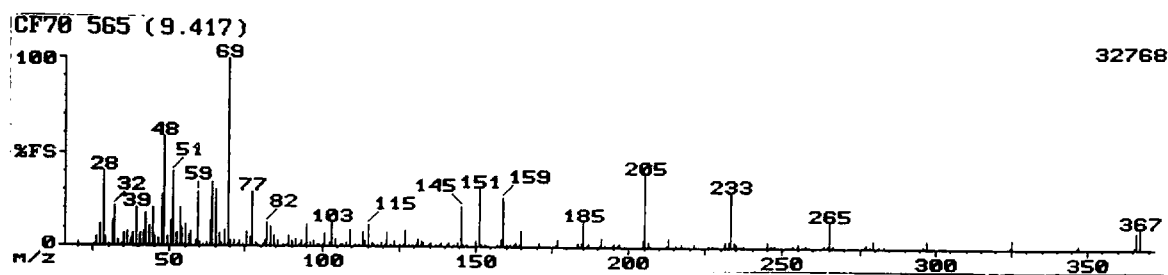

32768

Mass	Rel Int	Mass	Rel Int	Mass	Rel Int	Mass	Rel Int
20	1.88	76	4.68	132	2.86	206	2.37
24	0.46	77	27.23	133	2.34	207	1.49
25	1.24	78	1.73	134	0.82	209	0.50
26	5.59	79	0.96	135	1.52	212	0.51
27	12.57	80	0.38	136	0.65	213	4.40
28	39.66	81	5.13	137	0.48	214	0.59
29	4.82	82	11.73	138	0.46	215	1.00
30	1.16	83	9.78	139	3.11	216	0.29
31	15.64	84	4.78	140	0.84	217	1.70
32	20.11	85	2.51	141	1.82	220	0.40
33	3.28	87	0.70	143	0.33	221	3.70
34	1.45	88	1.00	144	1.48	226	0.69
35	5.24	89	4.89	145	20.39	227	1.39
36	6.08	90	2.30	146	1.14	230	0.35
37	3.98	91	4.12	147	0.78	231	3.60
38	6.01	92	0.56	150	3.14	232	2.27
39	20.81	93	2.37	151	30.45	233	23.18
40	7.47	94	1.21	152	1.51	234	2.21
41	8.52	95	10.89	153	0.78	235	2.03
42	19.13	96	3.11	155	0.58	237	1.08
43	11.17	97	2.93	157	1.41	244	0.31
44	18.99	98	0.77	158	3.39	245	2.30
45	5.34	99	0.76	159	24.02	246	0.65
47	1.73	100	0.72	160	1.33	247	0.79
47	29.05	101	6.11	161	0.65	254	0.41
48	53.63	102	1.41	162	0.38	255	4.47
49	4.12	103	11.87	163	2.04	257	0.54
50	13.13	104	3.81	164	1.19	263	0.75
51	38.55	105	0.58	165	5.48	264	0.82
52	6.77	106	0.54	166	0.87	265	9.64
53	19.27	107	0.72	167	0.66	266	1.13
54	9.08	108	1.05	171	1.15	267	0.43
55	11.31	109	7.58	173	0.59	276	0.43
56	5.90	110	0.50	176	0.94	277	1.68
57	7.61	111	0.56	177	2.30	278	0.52
58	2.55	112	1.24	182	0.22	279	3.56
59	29.05	113	6.91	183	1.55	281	0.43
60	1.68	114	3.18	184	1.47	283	0.60
61	0.64	115	11.03	185	11.59	296	0.71
63	0.93	116	1.60	186	0.46	297	5.66
63	13.41	117	0.71	187	1.40	298	0.46
64	31.42	119	0.88	189	0.53	305	0.51
65	28.91	120	1.01	190	0.56	324	0.43
66	6.81	121	7.54	191	3.74	325	3.74
67	2.01	122	1.39	192	0.35	326	0.54
68	9.22	123	1.84	193	1.29	327	0.99
69	100.00	125	0.91	194	0.39	346	0.79
70	3.11	126	1.14	195	1.93	347	1.48
71	2.97	127	8.45	196	0.53	365	0.84
72	0.85	128	0.60	197	2.23	366	5.38
73	2.23	129	0.27	203	0.65	367	7.86
74	1.00	130	1.15	204	3.35		
75	7.47	131	5.80	205	30.59		

Mass Spectrum 59: 1-(1,1,2,3,3,3-Hexafluoropropyl)-1,2-dibromocyclohexane (149).

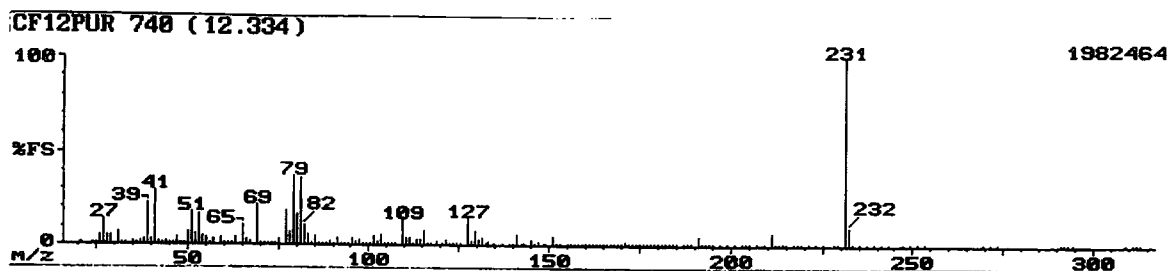

Mass	Rel Int	Mass	Rel Int	Mass	Rel Int	Mass	Rel Int
20	0.63	79	36.98	133	1.70	191	4.96
21	0.05	80	16.74	134	0.33	192	0.54
24	0.48	81	36.16	135	0.67	193	0.41
25	1.02	82	10.23	137	0.35	194	0.08
26	4.55	83	5.42	139	1.11	195	0.07
27	13.84	84	1.32	140	0.85	197	0.40
28	5.11	85	4.44	141	5.89	199	0.30
29	4.86	86	0.36	142	1.21	201	0.19
31	6.51	87	0.28	143	0.75	203	0.37
32	1.32	88	1.27	145	2.92	204	0.25
33	1.12	89	2.10	146	0.35	205	0.15
35	1.56	90	1.16	147	1.73	207	0.08
36	1.15	91	3.56	148	0.14	209	0.58
37	2.18	92	0.55	149	0.46	211	7.13
38	3.23	93	1.07	151	4.96	212	1.12
39	21.90	94	0.43	152	0.40	213	1.39
40	2.85	95	4.03	153	0.76	214	0.12
41	29.34	96	2.20	155	0.32	215	0.05
42	1.82	97	2.65	156	0.08	217	0.39
43	0.57	98	0.78	157	0.65	218	0.05
44	1.82	99	0.59	158	0.40	219	0.03
45	0.89	100	0.38	159	1.34	221	0.06
46	0.45	101	4.91	160	0.29	223	0.10
47	4.34	102	1.70	161	0.73	225	0.05
48	0.33	103	5.73	162	0.17	228	0.04
49	0.76	104	0.58	163	0.90	229	0.56
50	6.56	105	0.32	164	0.12	231	100.00
51	17.77	106	0.42	165	1.16	232	9.25
52	5.48	107	1.27	166	0.13	233	0.51
53	16.74	109	14.05	167	0.57	235	0.12
54	4.44	110	4.24	168	0.16	237	0.08
55	4.24	111	3.56	169	0.77	239	0.05
56	0.61	112	0.64	170	0.44	241	0.08
57	3.16	113	2.43	171	2.34	243	0.06
59	4.29	114	2.75	172	0.25	247	0.03
60	0.23	115	8.01	173	0.51	249	0.06
61	0.33	116	0.89	174	0.08	251	0.09
62	0.31	117	0.47	175	0.09	253	0.05
63	3.62	119	1.87	176	0.08	269	0.05
65	10.28	120	0.65	177	0.49	271	0.13
66	2.49	121	2.61	178	0.05	273	0.08
67	1.74	122	0.83	179	0.17	291	1.37
69	21.69	123	1.12	180	0.10	292	0.11
70	0.74	124	0.20	181	0.44	293	1.39
71	0.77	125	0.44	182	0.09	294	0.10
72	0.24	127	14.46	183	0.57	309	0.07
73	0.65	128	2.07	184	0.08	311	0.64
74	0.73	129	7.75	185	0.74	312	0.06
75	3.10	130	2.96	187	0.20	313	0.54
77	18.80	131	3.98	188	0.04		
78	7.13	132	0.82	189	0.56		

Mass Spectrum 60: 1-(1,1,2,3,3,3-Hexafluoropropyl)-1,2-dibromocyclopentane (150).



Mass	Rel Int	Mass	Rel Int	Mass	Rel Int	Mass	Rel Int
20	0.02	79	1.81	132	0.34	188	0.05
25	0.03	80	1.53	133	2.85	189	0.42
26	0.67	81	2.43	134	0.23	190	0.11
27	3.80	82	4.18	135	3.27	191	0.15
28	1.15	83	2.98	136	0.21	193	0.15
29	0.34	84	1.68	137	0.58	194	0.06
31	0.76	85	0.84	138	0.12	195	1.22
32	0.23	86	0.15	139	0.84	196	0.26
33	0.48	87	0.58	140	0.08	197	14.28
35	0.06	88	3.24	141	0.06	198	1.71
36	0.27	89	3.72	142	0.05	199	0.47
37	0.58	90	1.20	143	0.17	200	0.03
38	2.57	91	0.58	144	0.25	201	0.11
39	16.05	92	0.16	145	3.63	205	0.07
40	2.86	93	1.28	146	0.78	207	0.13
41	14.87	94	0.38	147	2.19	209	0.06
42	0.93	95	10.99	148	0.44	211	0.05
43	0.09	96	6.58	149	0.10	213	0.06
44	0.53	97	11.64	150	0.12	215	0.10
45	0.23	98	1.69	151	3.01	217	100.00
46	0.13	99	1.05	152	0.23	218	9.41
47	0.99	100	0.57	153	2.04	219	0.44
48	0.04	101	5.72	154	0.11	223	0.02
49	0.12	102	1.10	155	0.92	225	0.03
50	1.81	103	2.42	156	0.08	227	0.04
51	9.41	104	0.24	157	1.50	229	0.03
52	1.23	105	0.46	158	0.22	231	0.05
53	2.43	106	0.73	159	1.25	233	0.18
54	0.16	107	2.07	160	0.12	235	0.27
55	0.09	108	1.05	161	0.10	237	0.27
56	0.30	109	6.45	162	0.04	239	0.14
57	2.58	110	0.55	163	0.32	247	0.03
58	0.52	111	0.52	164	0.08	249	0.06
59	2.86	112	0.19	165	0.17	251	0.09
60	0.25	113	3.49	166	0.11	253	0.05
61	0.50	114	4.74	167	0.75	257	0.13
62	1.35	115	26.05	168	0.20	258	0.03
63	3.95	116	8.22	169	0.58	259	0.12
64	1.51	117	7.43	170	0.36	269	0.03
65	14.93	118	0.53	171	1.40	271	0.03
66	13.36	119	2.66	172	0.10	275	0.02
67	42.11	120	1.15	173	0.18	277	0.70
68	2.93	121	2.47	174	0.03	278	0.06
69	19.47	122	0.95	175	0.25	279	0.66
70	1.35	123	0.10	176	0.12	280	0.06
71	1.43	124	0.04	177	11.97	294	0.02
72	0.25	125	0.53	178	1.27	295	0.16
73	0.21	126	0.15	179	0.25	296	0.05
74	0.39	127	23.68	181	0.12	297	4.93
75	4.74	128	4.21	182	0.04	298	0.40
76	0.63	129	1.94	183	0.10	299	4.54
77	12.30	130	0.16	185	0.06	300	0.37
78	1.10	131	1.33	187	0.24		

Mass Spectrum 61: 1-(1,1,2,3,3,3-Hexafluoropropyl)-5-bromocyclopentene (151).

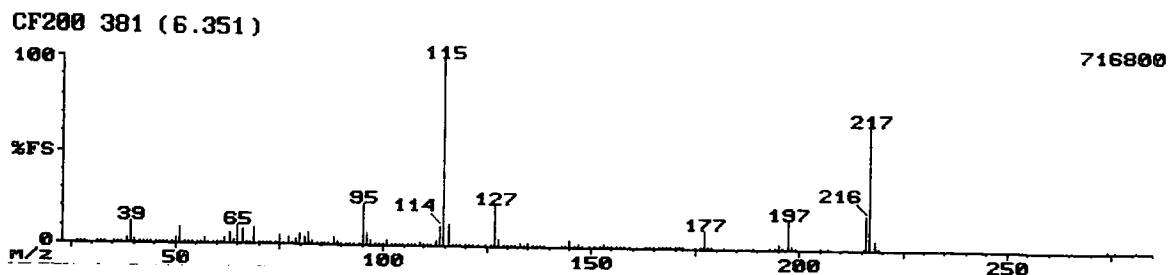

Mass	Rel Int	Mass	Rel Int	Mass	Rel Int	Mass	Rel Int
26	0.14	69	8.75	109	2.17	154	0.12
27	0.46	70	1.03	110	0.19	155	0.08
28	0.21	71	0.44	111	0.10	156	0.08
31	0.47	72	0.06	112	0.23	157	0.69
32	0.23	73	0.12	113	2.96	158	0.14
33	0.21	74	0.59	114	10.86	159	0.09
35	0.10	75	4.61	115	100.00	163	0.20
36	0.57	76	0.57	116	11.71	164	0.11
37	0.76	77	3.86	117	0.67	165	0.32
38	2.93	78	0.64	118	0.09	166	0.17
39	11.57	79	3.21	119	0.69	167	0.62
40	1.94	80	5.54	120	0.12	168	0.07
41	0.79	81	3.86	121	0.47	169	0.12
42	0.05	82	7.11	122	0.05	170	0.02
43	0.16	83	1.61	123	0.05	171	0.88
44	0.30	84	0.88	125	0.57	172	0.06
45	0.19	85	0.38	126	0.23	175	0.14
46	0.08	86	0.19	127	22.43	176	0.24
47	0.43	87	0.67	128	3.64	177	9.71
48	0.04	88	3.86	129	1.06	178	0.87
49	0.25	89	2.29	130	0.10	179	0.05
50	2.75	90	0.33	131	0.28	182	0.03
51	8.43	91	0.11	132	0.44	189	0.11
52	0.93	92	0.17	133	2.39	193	0.08
53	0.30	93	0.44	134	0.23	194	0.02
54	0.05	94	0.58	135	1.94	195	2.64
55	0.05	95	22.14	136	0.14	196	0.59
56	0.41	96	6.57	137	0.33	197	15.14
57	2.68	97	2.82	138	0.12	198	1.50
58	0.32	98	0.53	139	0.26	199	0.09
59	1.31	99	0.86	143	0.11	205	0.08
60	0.14	100	0.37	144	0.11	207	0.11
61	1.11	101	3.29	145	3.50	215	0.34
62	2.57	102	0.35	146	0.67	216	18.29
63	6.00	103	1.15	147	1.52	217	65.71
64	1.78	104	0.13	148	0.25	218	4.89
65	10.14	105	0.21	150	0.06	219	0.21
66	7.93	106	0.23	151	1.37	274	0.08
67	0.79	107	1.13	152	0.11	276	0.09
68	0.56	108	0.27	153	1.76	281	0.04

Mass Spectrum 62: 1-(1,1,2,3,3,3-Hexafluoropropyl)-cyclopentene epoxide (152).

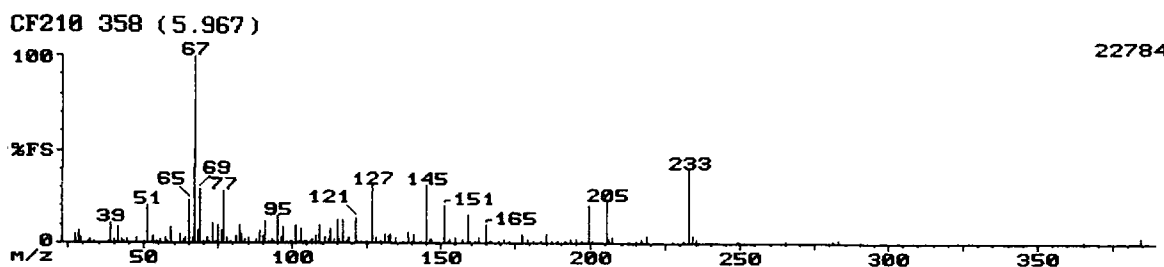

Mass	Rel Int	Mass	Rel Int	Mass	Rel Int	Mass	Rel Int
27	4.42	75	10.18	115	12.64	167	0.93
28	7.16	76	6.67	116	2.37	169	0.77
29	2.79	77	28.37	117	12.50	171	1.74
31	0.94	78	3.13	118	1.07	173	0.93
32	1.84	79	0.79	119	3.37	177	4.99
33	0.81	81	4.28	121	13.48	179	2.32
38	1.21	82	9.90	122	1.30	181	1.09
39	10.32	83	4.85	123	0.86	183	1.00
40	1.74	84	2.41	125	0.63	185	4.92
41	8.29	85	3.14	127	31.46	187	1.40
42	2.28	88	2.35	128	2.48	189	1.26
43	1.16	89	7.16	129	0.66	191	1.28
44	1.84	90	3.77	130	0.96	193	1.83
47	2.74	91	12.01	131	4.78	195	2.07
50	1.32	92	0.72	132	3.53	197	1.07
51	20.51	93	2.30	133	4.92	199	20.22
52	0.93	94	0.65	135	3.11	200	1.28
53	3.76	95	14.96	137	0.57	205	22.75
54	1.14	96	3.02	139	5.83	206	2.11
55	2.41	97	8.78	140	1.16	207	2.98
57	3.35	98	1.12	141	5.06	213	1.19
58	0.79	99	0.99	143	0.71	215	0.96
59	8.57	100	0.79	145	31.18	217	2.21
62	4.63	101	9.83	146	1.90	219	3.79
63	2.37	102	1.25	147	2.42	227	0.57
64	3.20	103	7.30	151	20.22	231	1.33
65	23.31	104	0.76	152	1.08	233	40.17
66	3.37	105	1.19	153	2.07	234	3.90
67	100.00	106	0.54	155	2.74	235	1.46
68	7.16	107	1.83	157	1.54	249	0.74
69	28.65	108	3.63	159	15.87	265	1.00
70	0.96	109	9.27	160	0.84	281	0.78
71	3.09	111	2.63	161	0.65	283	1.90
72	0.86	112	1.62	163	2.48	365	0.84
73	10.96	113	7.37	165	9.34	384	2.76
74	0.85	114	2.02	166	1.04		

Mass Spectrum 63: 1-(1,1,2,3,3,3-Hexafluoropropyl)-cyclohexene epoxide (153).

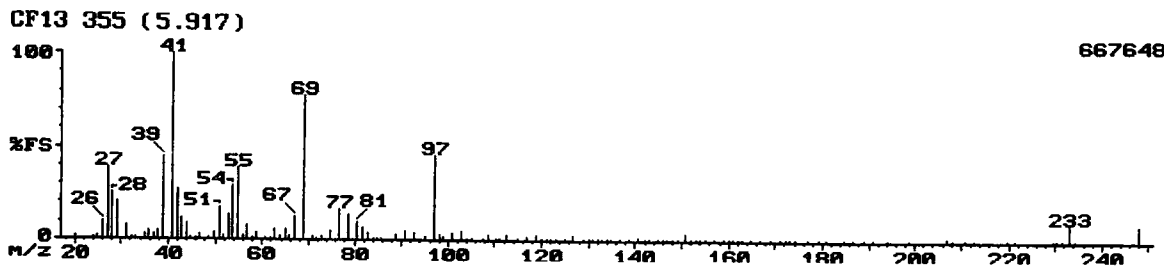

Mass	Rel Int	Mass	Rel Int	Mass	Rel Int	Mass	Rel Int
20	1.48	62	0.88	113	2.61	160	0.16
24	0.78	63	5.60	115	1.37	161	0.36
25	1.90	64	2.23	117	1.47	162	0.04
26	9.78	65	6.17	119	3.30	163	0.12
27	38.96	66	1.67	120	0.36	165	0.32
28	25.31	67	12.27	121	0.69	167	0.90
29	20.71	69	77.91	122	0.17	169	0.15
31	7.44	71	2.20	123	0.24	171	0.23
32	1.06	72	0.43	125	0.19	172	0.23
33	0.55	73	1.76	127	2.99	173	0.29
35	2.76	75	4.49	129	1.26	174	0.20
36	4.49	77	16.10	130	0.44	177	0.09
37	2.65	79	13.50	131	0.96	179	0.07
38	4.60	81	9.51	132	0.45	181	0.33
39	44.79	82	6.86	133	0.50	185	0.61
41	100.00	83	3.68	134	0.07	187	0.83
42	27.30	84	0.64	135	0.17	189	0.56
43	11.20	85	1.12	137	0.22	191	0.23
44	8.32	86	0.07	139	1.20	194	0.24
45	1.26	89	2.84	141	1.71	199	0.15
46	0.47	91	4.45	142	0.15	207	2.11
47	2.80	93	3.68	143	0.10	208	0.12
49	0.85	95	1.78	145	1.07	211	0.13
50	4.22	97	45.40	146	0.21	213	0.09
51	17.48	98	2.80	147	0.45	220	0.63
52	2.20	99	1.57	148	0.05	221	0.06
53	13.65	101	3.60	149	0.10	229	0.14
54	29.14	103	4.79	151	3.57	230	0.30
55	39.26	104	0.37	152	0.17	231	0.35
56	1.98	105	0.48	153	0.17	233	9.82
57	7.75	107	0.18	154	0.12	234	0.39
58	0.18	109	3.11	155	0.11	248	8.93
59	4.29	110	0.36	157	0.29		
61	0.48	111	0.43	159	1.41		

Mass Spectrum 64: 1-(1,1,2,3,3,3-Hexafluoropropyl)-cyclohexane-1,2-diol (154).

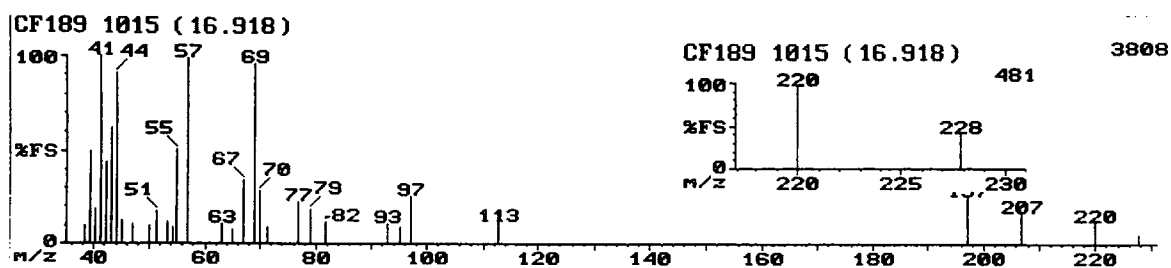

Mass	Rel Int	Mass	Rel Int	Mass	Rel Int	Mass	Rel Int
38	3.74	47	4.09	65	2.74	93	3.94
39	18.06	50	3.43	67	12.35	95	3.13
40	6.75	51	6.37	69	35.34	97	9.34
41	36.73	53	4.24	70	10.34	113	4.24
42	16.20	54	3.28	71	3.24	197	9.14
43	22.84	55	18.67	77	8.37	207	5.94
44	33.49	57	36.42	79	6.91	220	4.44
45	4.63	63	3.90	82	4.28	228	1.91

Mass Spectrum 65: 3,6-Dibromo-(1,1,2,3,3,3-hexafluoropropyl)-cyclohexene (155).

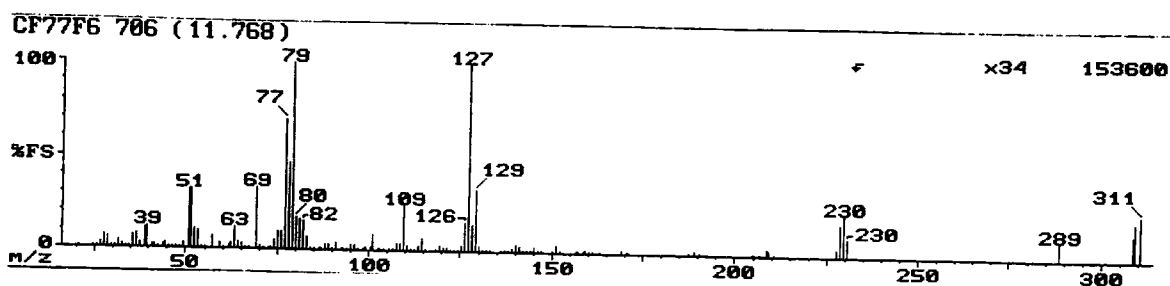

Mass	Rel Int	Mass	Rel Int	Mass	Rel Int	Mass	Rel Int
20	0.88	62	2.92	100	1.93	141	2.67
25	0.22	63	11.50	101	8.75	142	0.58
26	0.56	64	4.00	102	1.30	143	0.24
26	2.79	65	3.04	103	0.91	144	0.43
27	6.46	66	0.45	104	0.28	145	2.71
28	5.96	67	0.24	105	0.41	146	0.36
29	0.54	69	33.17	106	0.74	147	0.26
31	0.85	70	1.83	107	3.54	150	0.68
31	3.92	71	0.61	108	3.67	151	3.79
32	1.48	72	0.17	109	24.50	152	0.28
33	0.54	73	1.16	110	2.96	156	0.21
34	1.09	74	4.79	111	0.46	157	0.63
35	7.04	75	10.08	112	0.70	158	0.65
36	7.83	76	10.17	113	2.88	159	1.60
37	3.04	77	70.00	114	6.96	160	0.38
39	10.29	78	46.67	115	1.24	161	0.18
39	11.83	79	100.00	118	0.45	163	0.18
41	2.40	80	17.33	119	2.57	169	1.82
41	1.78	81	16.67	120	2.20	170	0.27
42	0.24	82	15.17	121	1.58	171	0.66
44	1.84	83	6.42	122	0.59	187	0.34
44	2.96	84	0.79	123	0.36	189	1.57
45	0.42	85	0.55	124	0.45	190	0.56
46	0.30	86	0.23	125	2.75	205	0.19
47	0.68	87	1.01	126	15.50	205	0.22
48	0.60	88	2.66	127	100.00	207	0.88
49	2.96	89	2.54	128	14.67	209	4.08
51	32.17	90	1.06	129	32.67	209	3.08
51	32.00	91	3.46	130	2.65	211	1.00
52	10.38	92	0.39	131	0.99	228	4.25
53	9.50	93	1.04	132	0.79	229	17.33
54	0.70	94	1.10	133	0.54	230	22.00
55	0.20	95	3.04	136	0.08	230	9.58
57	6.33	96	2.92	137	0.34	289	0.27
59	3.33	97	0.79	138	1.34	308	0.39
60	0.30	98	0.35	139	1.72	309	0.59
62	2.19	99	1.86	140	4.00	311	0.70

Mass Spectrum 66: (1,1,2,3,3,3-Hexafluoropropyl)-benzene (156).

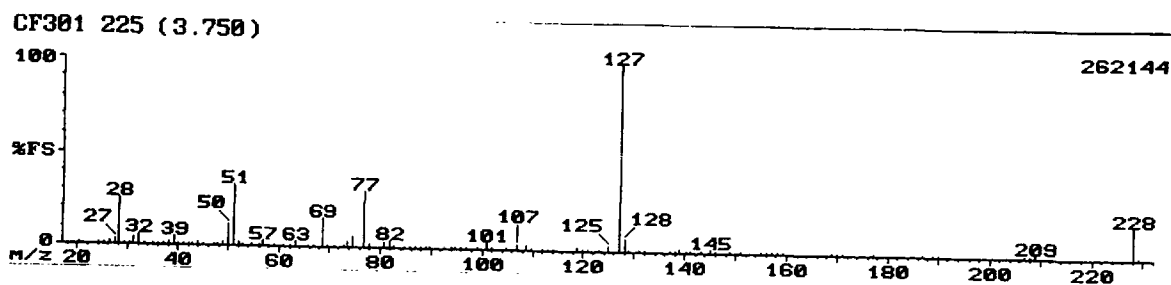

Mass	Rel Int	Mass	Rel Int	Mass	Rel Int	Mass	Rel Int
20	0.76	52	2.27	90	0.27	138	1.11
24	0.24	53	0.22	93	0.49	139	1.88
25	0.25	55	0.21	94	0.19	140	1.21
26	1.81	56	0.52	95	0.94	141	0.18
27	2.73	57	3.00	96	1.20	143	0.13
28	25.00	59	0.24	97	0.46	145	2.34
29	0.95	61	0.78	99	0.76	146	0.19
30	0.09	62	1.00	101	3.93	149	0.11
31	3.52	63	2.44	102	0.21	151	0.43
32	5.54	66	0.20	105	0.25	155	0.54
33	0.41	67	0.18	107	2.86	156	0.11
35	0.57	69	15.33	109	2.83	157	0.32
36	0.91	70	0.65	110	0.09	158	1.23
37	1.15	71	0.06	112	0.15	159	0.22
38	2.15	73	0.31	113	0.34	169	1.07
39	4.88	74	3.05	114	0.56	170	0.15
40	0.74	75	6.25	119	1.53	171	0.12
41	0.82	77	29.69	120	1.24	177	0.23
42	0.47	78	1.90	121	0.33	187	0.24
43	0.54	81	2.71	123	0.12	189	0.59
44	2.39	82	3.96	125	3.10	190	0.16
45	0.29	83	0.78	127	100.00	207	0.54
47	0.99	85	0.23	128	6.84	208	0.34
48	0.21	86	0.14	129	0.30	209	2.00
49	1.46	87	0.20	131	0.15	228	17.68
50	11.52	88	1.08	132	0.32	229	1.13
51	33.20	89	1.03	137	0.26		

Mass Spectrum 67: 2-Bromo-(1,1,2,3,3,3-hexafluoropropyl)-benzene (157).

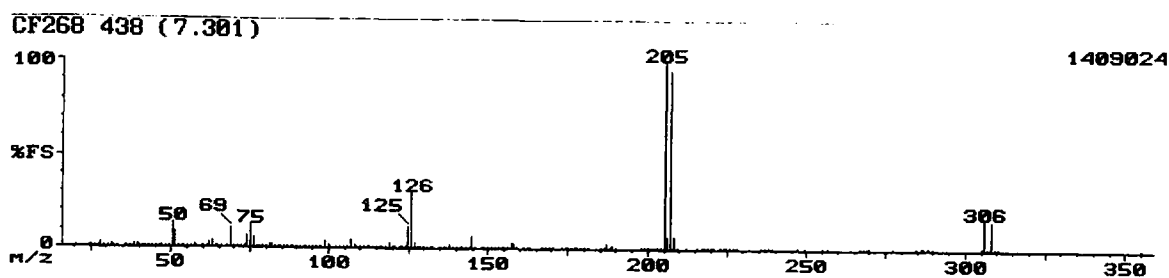

Mass	Rel Int	Mass	Rel Int	Mass	Rel Int	Mass	Rel Int
20	0.09	76	6.18	128	0.30	190	0.07
24	0.01	77	0.82	129	0.16	198	0.03
25	0.06	78	0.13	130	0.14	199	0.02
26	0.33	79	0.83	131	0.41	200	0.04
27	0.59	80	0.81	132	0.33	203	0.02
28	3.05	81	2.27	133	0.04	204	0.71
29	0.17	82	2.00	135	0.05	205	100.00
30	0.03	83	0.17	136	0.03	206	7.12
31	1.94	84	0.12	137	1.44	207	95.35
32	0.95	85	0.50	138	2.25	208	6.83
33	0.11	86	0.67	139	1.18	209	0.30
35	0.02	87	1.44	140	0.12	212	0.01
36	0.16	88	1.20	141	0.03	216	0.04
37	1.00	89	0.61	142	0.02	217	0.02
38	2.40	90	0.05	143	0.38	218	0.68
39	1.89	91	0.06	144	1.33	219	0.03
40	0.15	92	0.39	145	6.69	220	0.65
41	0.17	93	0.91	146	0.55	221	0.05
42	0.05	94	0.73	148	0.07	223	0.73
43	0.33	95	0.89	149	0.07	224	0.12
44	1.34	96	0.12	150	0.10	225	0.73
45	0.09	97	0.04	151	0.12	226	0.31
46	0.03	98	0.48	152	0.02	227	0.11
47	0.04	99	3.78	153	0.04	228	0.04
48	0.07	100	1.93	154	0.03	236	0.13
49	1.18	101	1.16	155	1.34	237	0.12
50	13.59	102	1.10	156	0.70	238	0.18
51	8.79	103	1.45	157	2.45	239	0.15
52	0.16	105	0.69	158	2.47	247	0.02
53	0.22	106	0.75	159	0.21	249	0.02
54	0.23	107	4.41	161	0.10	255	0.11
55	0.20	108	1.87	162	0.02	257	0.06
56	0.33	109	0.17	163	0.08	267	0.20
57	2.05	110	0.03	167	0.15	268	0.03
58	0.09	111	0.20	168	0.05	269	0.11
60	0.11	112	0.64	169	0.90	270	0.02
60	0.06	113	0.77	170	0.10	277	0.02
61	1.07	114	0.20	173	0.02	285	0.03
62	2.67	115	0.03	174	0.03	286	0.01
63	4.22	116	0.07	175	0.04	287	0.71
64	0.19	117	0.48	176	0.28	288	0.05
65	0.03	118	0.45	177	0.40	289	0.69
66	0.02	119	3.18	178	0.04	290	0.06
67	0.02	120	0.55	179	0.03	305	0.08
69	10.76	121	0.07	180	0.02	306	16.28
70	0.43	122	0.01	181	0.07	307	1.33
71	0.07	123	0.45	185	0.03	308	15.99
72	0.09	124	0.27	186	0.04	309	1.33
73	1.24	125	11.77	187	2.78	310	0.05
74	6.98	126	30.52	188	0.65	355	0.03
75	12.21	127	3.23	189	1.67		

Mass Spectrum 68: 1-(1,2,3,3,3-Pentafluoro-Z-prop-1-enyl)-cyclopentene (159).

CF5DIENE 175 (2.917)

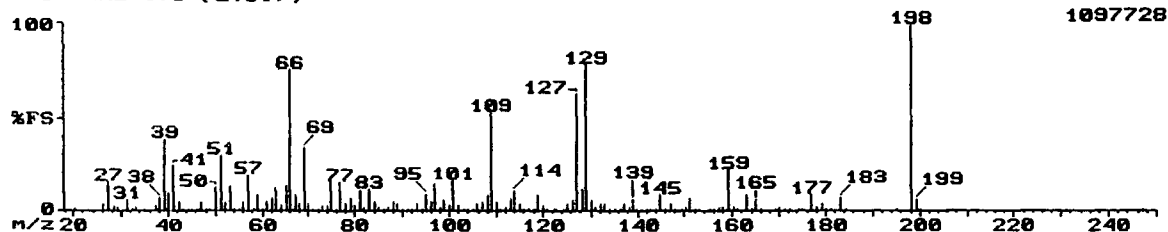

Mass	Rel Int	Mass	Rel Int	Mass	Rel Int	Mass	Rel Int
20	0.05	68	3.99	107	5.08	146	1.45
26	3.43	69	33.96	108	8.30	147	3.78
27	15.67	70	3.68	109	52.99	148	0.41
28	2.71	71	1.43	110	5.25	149	0.19
29	1.91	72	0.72	111	0.61	150	2.43
31	5.97	73	3.36	112	1.52	151	6.90
32	0.47	74	3.24	113	6.53	152	0.97
33	2.26	75	15.11	114	10.45	153	0.10
37	2.89	76	1.38	115	3.54	155	0.31
38	7.18	77	15.30	116	0.30	156	1.07
39	38.81	78	3.64	117	0.43	157	2.17
40	9.33	79	7.28	118	1.00	158	1.56
41	24.25	80	2.94	119	9.14	159	21.92
42	4.92	81	10.26	120	2.54	160	1.48
43	0.28	82	1.66	121	1.40	161	0.26
44	0.53	83	11.19	122	0.08	163	8.30
45	1.18	84	4.69	123	0.41	164	0.65
46	0.65	85	1.54	124	0.35	165	5.88
47	4.76	86	0.73	125	3.52	166	0.36
48	0.23	87	2.15	126	5.50	169	0.80
49	1.27	88	5.15	127	63.43	170	2.05
50	12.22	89	4.15	128	11.19	171	0.29
51	29.85	90	0.58	129	78.36	172	0.04
52	5.32	91	0.50	130	5.97	174	0.10
53	13.15	92	0.82	131	1.94	175	0.40
54	1.06	93	3.47	132	3.52	177	8.58
55	0.67	94	0.73	133	3.87	178	1.84
56	4.71	95	8.68	134	0.44	179	3.61
57	18.94	96	5.29	135	0.06	180	0.29
58	1.28	97	14.65	136	0.36	181	0.24
59	8.86	98	1.98	137	4.34	183	7.18
60	0.98	99	5.60	138	1.54	184	0.41
61	4.41	100	2.94	139	5.39	195	0.44
62	6.62	101	16.51	140	0.56	198	100.00
63	12.78	102	2.47	141	0.08	199	5.97
64	2.89	103	0.89	142	0.10	200	0.23
65	13.71	104	0.36	143	0.98	207	0.04
66	76.12	105	1.06	144	0.80		
67	8.68	106	4.29	145	8.77		

Mass Spectrum 69: 1-(1,2,3,3,3-Pentafluoro-Z-prop-1-enyl)-cyclohexene (160).

CF76 255 (4.250)

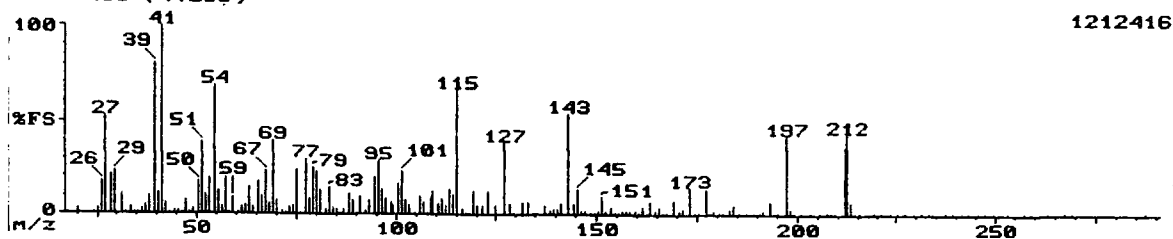

1212416

Mass	Rel Int	Mass	Rel Int	Mass	Rel Int	Mass	Rel Int
20	2.89	73	3.51	125	5.05	184	5.11
24	1.35	74	5.00	127	38.85	185	0.53
25	3.27	75	24.66	128	5.49	187	0.78
26	17.06	76	1.41	129	1.11	188	0.26
27	52.36	77	30.07	132	6.42	189	0.79
28	20.95	78	8.78	133	6.33	190	0.51
29	22.97	79	25.00	134	1.08	191	1.48
31	10.98	80	23.31	135	0.15	193	6.84
32	0.90	81	13.94	137	4.71	194	0.68
33	3.67	82	2.93	138	2.11	195	0.73
34	0.14	83	14.86	139	2.64	197	42.57
35	1.10	84	3.55	140	2.83	198	3.23
36	2.47	85	2.91	141	6.08	199	0.21
37	5.11	86	1.04	143	54.73	201	0.18
38	9.88	87	2.89	144	6.00	203	0.14
39	80.74	88	11.32	145	13.26	205	0.08
40	11.57	89	7.94	146	2.15	207	0.16
41	100.00	90	0.50	147	1.77	208	0.31
42	5.74	91	10.14	148	0.30	209	0.47
43	0.98	92	2.28	149	0.60	212	36.49
44	2.03	93	8.19	150	2.34	212	43.24
45	2.26	95	20.27	151	9.88	213	6.50
46	1.31	95	29.05	152	1.75	214	0.27
47	7.94	97	13.51	153	3.59	216	0.06
48	0.84	97	9.12	154	0.43	217	0.06
49	2.53	99	6.76	155	0.40	219	0.05
50	17.15	99	4.37	156	1.75	221	0.18
51	38.85	101	16.81	157	2.15	223	0.12
52	10.64	101	23.31	158	2.15	225	0.03
53	19.43	102	7.85	159	1.46	227	0.17
54	69.26	103	4.43	160	0.55	229	0.06
55	12.50	105	1.00	161	3.95	231	0.10
56	4.27	106	9.29	163	6.84	233	0.15
57	19.26	107	6.67	164	2.36	234	0.03
58	1.39	108	1.30	165	3.44	237	0.05
59	9.04	109	10.14	166	0.55	239	0.10
60	0.98	109	12.42	167	0.21	241	0.07
61	3.42	111	5.57	169	8.11	243	0.02
62	5.32	111	8.28	170	1.69	245	0.18
63	14.95	113	5.03	171	3.10	247	0.05
64	4.31	114	13.43	173	14.10	249	0.04
65	17.57	114	10.56	174	1.37	251	0.09
66	9.97	115	66.89	175	0.55	253	0.07
67	22.97	116	2.93	177	13.43	257	0.02
68	6.08	117	0.42	178	1.41	259	0.04
69	40.20	119	12.58	179	1.67	263	0.05
70	7.52	120	4.52	180	0.20	267	0.03
71	2.36	121	4.67	181	0.44	269	0.03
72	1.39	123	12.42	183	2.72	287	0.02

Mass Spectrum 70: 1-(Perfluorocyclopent-1-enyl)-cyclopentene (161).

CF215 330 (5.501)

335872

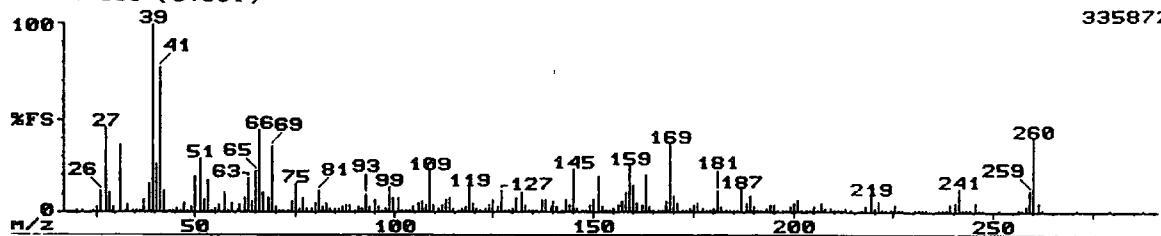

Mass	Rel Int	Mass	Rel Int	Mass	Rel Int	Mass	Rel Int
20	1.12	77	7.85	131	7.55	185	0.20
22	0.06	78	1.79	132	10.44	186	1.07
24	0.89	79	1.83	133	3.87	187	12.27
25	3.01	80	4.40	134	0.39	188	4.48
26	11.43	81	11.28	135	0.12	189	8.99
27	45.73	82	2.88	136	0.91	190	2.65
28	10.82	83	5.11	137	6.40	191	1.31
29	3.09	84	1.73	138	7.16	192	0.69
31	36.59	85	2.04	139	2.92	193	1.68
32	0.99	86	1.56	140	5.95	194	3.47
33	4.29	87	3.07	141	2.55	195	3.49
34	0.09	88	4.02	142	1.15	196	0.46
35	0.88	89	4.27	143	7.01	197	0.04
36	1.22	90	1.21	144	4.34	198	0.37
37	6.94	91	3.14	145	23.78	199	3.18
38	15.70	92	2.04	146	2.17	200	4.38
39	100.00	93	9.30	147	0.27	201	6.86
40	26.22	94	2.55	148	0.54	202	0.84
41	78.05	95	6.94	149	3.87	203	0.12
42	11.28	96	3.26	150	6.78	204	0.20
43	0.54	97	0.83	151	19.36	205	2.63
44	1.22	98	1.70	152	2.99	206	0.94
45	1.83	99	13.11	153	0.52	207	4.44
46	1.31	100	7.62	154	0.25	208	1.47
47	5.03	101	8.23	155	2.38	209	2.38
48	0.90	102	1.16	156	3.96	210	0.50
49	3.33	103	0.59	157	6.02	211	0.39
50	19.82	104	0.76	158	10.21	212	1.17
51	28.96	105	2.59	159	25.00	213	2.38
52	7.16	106	4.88	160	14.48	214	0.35
53	17.30	107	6.17	161	5.03	217	0.19
54	0.97	108	3.85	162	3.98	218	2.46
55	2.23	109	22.56	163	20.12	219	9.07
56	4.23	110	3.60	164	2.46	220	2.29
57	11.05	111	1.70	165	0.32	221	5.95
58	1.01	112	4.08	166	0.09	222	0.74
59	5.18	113	6.78	167	1.07	223	0.26
60	0.85	114	7.47	168	5.87	224	0.36
61	4.31	115	2.10	169	36.59	225	3.89
62	7.93	116	0.50	170	8.38	226	0.64
63	18.90	117	2.08	171	5.03	227	0.87
64	5.79	118	2.50	172	0.80	230	0.11
65	22.56	119	13.41	173	0.39	231	0.75
66	45.12	120	4.80	174	2.27	232	0.26
67	10.59	121	2.31	175	3.93	233	0.10
68	8.08	122	0.57	176	5.03	236	0.12
69	35.67	123	1.96	177	2.17	237	1.01
70	2.80	124	4.19	178	0.85	238	0.82
71	1.33	125	6.48	179	0.47	239	4.02
72	0.50	126	2.59	180	1.71	240	4.67
73	0.64	127	11.89	181	11.81	241	12.80
74	5.87	128	1.26	182	3.35	242	1.30
75	15.24	129	0.41	183	0.94	243	0.13
76	2.19	130	1.96	184	0.13	244	0.72
245	4.52	256	0.05	260	39.63	279	0.10
246	0.49	257	0.46	261	4.44	287	0.09
247	0.05	258	3.39	262	0.19		
251	0.15	259	12.12	271	0.16		

Mass Spectrum 71: 1-(Perfluorocyclopent-2-enyl)-cyclopentene.

CF215 261 (4.350)

319488

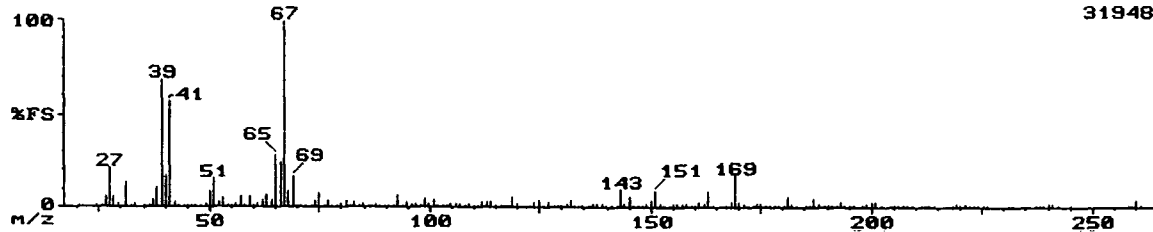

Mass	Rel Int	Mass	Rel Int	Mass	Rel Int	Mass	Rel Int
20	0.52	77	4.01	130	0.81	185	0.10
25	0.48	78	1.19	131	2.26	186	0.55
25	1.25	79	0.94	132	3.65	187	5.29
26	6.01	80	1.58	133	1.44	188	1.52
27	21.15	81	4.29	134	0.06	189	1.32
28	5.93	82	0.82	136	0.36	190	0.84
29	2.22	83	2.60	137	2.24	191	0.33
31	13.62	84	1.42	138	1.74	192	0.56
32	0.81	85	1.58	139	2.16	193	2.50
33	1.86	86	1.07	140	1.32	194	1.13
35	0.34	87	1.32	141	0.37	195	0.68
36	0.74	88	1.50	142	0.95	196	0.08
37	4.09	89	0.59	143	9.38	198	0.23
38	10.42	90	0.33	144	2.36	199	1.74
39	69.23	91	0.28	145	5.37	200	2.62
40	17.71	92	1.20	146	0.32	201	3.27
41	57.05	93	7.13	147	0.12	202	0.43
42	3.35	94	1.21	148	0.28	204	0.11
43	0.70	95	2.64	149	2.28	205	1.36
44	1.36	96	1.66	150	4.13	206	0.34
45	1.19	97	1.64	151	9.21	207	0.88
46	0.89	98	0.83	152	1.56	208	0.27
47	1.44	99	5.29	153	0.23	209	0.17
48	0.52	100	2.18	154	0.17	211	0.13
49	1.46	101	3.79	155	1.62	212	0.42
50	8.41	102	0.60	156	1.94	213	0.83
51	15.54	103	0.37	157	1.88	214	0.37
52	3.02	104	0.47	158	1.72	217	0.08
53	5.21	105	1.80	159	0.98	218	0.78
54	0.46	106	1.48	160	0.55	219	2.12
55	1.36	107	1.62	161	2.64	220	0.73
56	2.16	108	0.60	162	2.14	221	2.24
57	5.77	109	2.02	163	8.57	222	0.29
58	0.90	110	0.40	164	0.92	223	0.12
59	6.25	111	0.93	166	0.05	224	0.08
60	0.70	112	2.64	167	0.57	225	0.36
61	2.04	113	3.27	168	2.84	226	0.13
62	3.67	114	2.76	169	17.23	231	0.08
63	6.73	115	0.69	170	3.21	232	0.44
64	3.57	116	0.17	171	1.86	237	0.12
65	27.88	117	1.25	172	0.31	238	0.15
66	24.36	118	0.88	173	0.26	239	0.66
67	100.00	119	5.53	174	2.00	240	2.30
68	8.65	120	2.20	175	2.06	241	1.48
69	16.19	121	0.83	176	1.34	242	0.13
70	1.10	123	1.44	177	0.70	245	0.17
71	0.91	124	3.29	178	0.07	258	0.10
72	0.31	125	3.65	179	0.32	259	0.88
73	0.45	126	1.04	180	1.11	260	4.15
74	4.09	127	2.98	181	5.61	261	0.47
75	7.85	128	0.17	182	1.48		
76	1.00	129	0.23	183	0.36		

Mass Spectrum 72: 1-(2,3,3,3-Tetrafluoro-1-methoxy-prop-1-enyl)-cyclopentene (163).

CF287F6 334 (5.567)

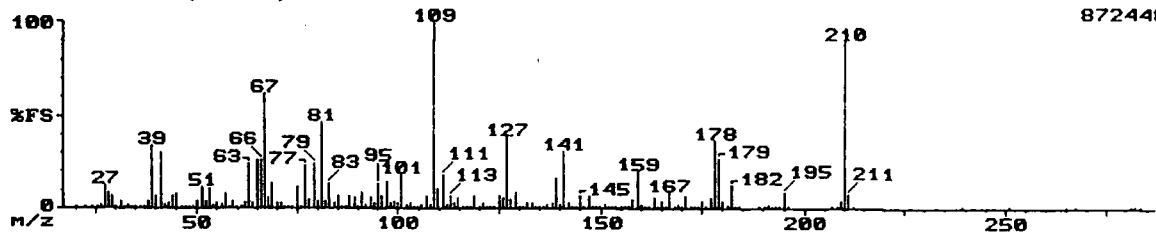

872448

Mass	Rel Int	Mass	Rel Int	Mass	Rel Int	Mass	Rel Int
20	0.14	68	5.58	114	3.37	160	1.75
22	0.07	69	13.97	115	5.60	161	1.03
24	0.04	70	2.96	116	0.59	162	0.33
25	0.08	71	3.20	117	0.93	163	6.10
26	1.88	72	0.51	118	0.41	164	0.80
27	12.32	73	1.26	119	6.87	165	3.79
28	8.80	74	1.12	120	1.45	166	0.38
29	6.87	75	11.38	121	3.02	167	9.15
30	1.04	76	1.44	122	0.46	168	0.78
31	3.93	77	23.00	123	1.36	169	2.05
32	1.40	78	5.11	124	0.23	170	0.17
33	1.64	79	24.53	125	6.66	171	6.66
34	0.04	80	3.64	126	5.84	172	0.61
35	1.07	81	46.48	127	38.50	173	0.12
36	0.19	82	4.23	128	4.69	174	0.28
37	1.17	83	13.97	129	9.15	175	3.49
38	4.17	84	2.61	130	1.41	176	1.12
39	34.27	85	6.43	131	1.03	177	5.55
40	6.92	86	0.94	132	2.49	178	36.62
41	30.05	87	1.41	133	3.14	179	27.58
42	2.32	88	7.07	134	0.60	180	4.17
43	3.02	89	5.90	135	0.43	181	2.38
44	6.92	90	1.34	136	0.25	182	12.68
45	7.45	91	8.80	137	1.63	183	1.10
46	0.38	92	1.71	138	2.44	184	0.08
47	1.17	93	5.55	139	16.08	189	0.56
48	0.06	94	3.32	140	2.05	190	0.34
49	0.37	95	13.38	141	31.46	191	1.65
50	3.67	96	6.60	142	2.55	192	0.18
51	11.50	97	14.67	143	0.68	193	0.21
52	4.28	98	3.02	144	0.32	194	0.24
53	10.33	99	4.34	145	7.25	195	8.45
54	1.80	100	3.29	146	1.03	196	0.65
55	3.29	101	18.78	147	6.92	207	1.23
56	1.46	102	2.11	148	0.83	208	0.23
57	7.45	103	2.49	149	0.62	209	4.34
58	1.22	104	0.48	150	0.56	210	90.61
59	3.61	105	1.02	151	1.68	211	7.86
60	0.19	106	1.47	152	1.23	212	0.54
61	1.33	107	6.92	153	0.51	239	0.04
62	2.88	108	1.91	154	0.87	251	0.02
63	24.65	109	100.00	155	1.14	265	0.02
64	2.88	110	10.21	156	0.94	267	0.04
65	25.94	111	18.43	157	1.42	281	0.26
66	26.64	112	1.91	158	4.69	282	0.08
67	62.44	113	7.28	159	20.31	283	0.03

Mass Spectrum 73: 1-(2,3,3,3-Tetrafluoro-1-propoxy-prop-1-enyl)-cyclopentene
(164).

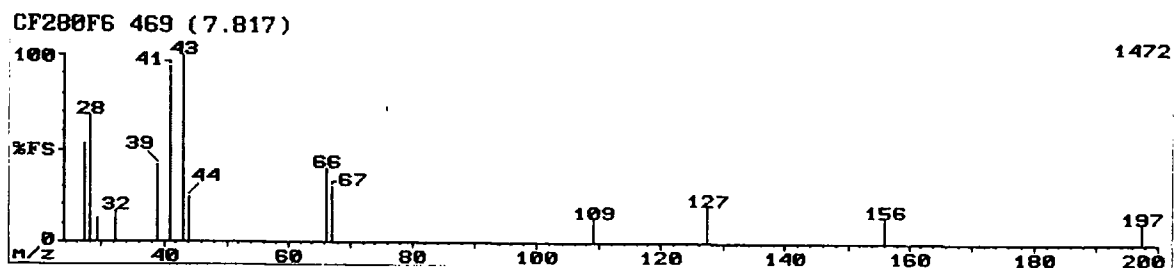

Mass	Rel Int	Mass	Rel Int	Mass	Rel Int	Mass	Rel Int
27	53.53	39	41.58	66	39.40	156	13.38
28	67.93	41	94.57	67	29.62	197	10.94
29	12.50	43	100.00	109	12.77		
32	16.30	44	23.91	127	19.84		

Mass Spectrum 74: 1-(2,3,3,3-Tetrafluoro-1-phenylmethoxy-prop-1-enyl)-cyclopentene (165).

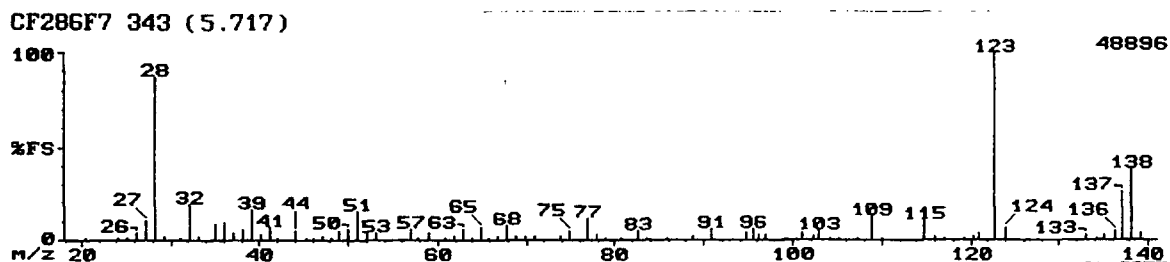

Mass	Rel Int	Mass	Rel Int	Mass	Rel Int	Mass	Rel Int
20	1.15	46	0.72	70	1.68	104	0.73
24	0.68	47	1.51	71	1.54	105	0.72
25	1.12	48	0.60	74	1.59	107	0.94
26	4.12	49	4.48	75	4.65	109	12.43
27	10.86	50	6.18	77	11.91	110	0.82
28	86.91	51	15.31	78	2.75	115	10.60
29	1.93	52	3.50	79	0.75	116	1.71
31	1.44	53	3.96	81	0.68	117	0.87
32	19.63	57	6.25	83	4.71	119	0.65
33	1.60	58	1.15	84	0.87	120	1.52
35	8.51	59	3.40	86	1.11	121	4.25
36	9.69	61	0.94	89	1.56	123	100.00
37	4.35	62	1.82	91	6.18	124	6.48
38	5.69	63	5.89	95	4.06	133	3.27
39	16.49	64	0.74	96	5.40	134	0.60
40	2.52	65	7.07	96	3.04	135	2.75
41	6.68	66	0.53	97	2.68	136	5.30
42	0.53	67	1.62	101	3.40	137	26.18
44	5.14	68	7.72	102	2.06	138	38.22
45	0.68	69	2.26	103	5.07	139	3.53

Mass Spectrum 75: 1-(1,2,3,3,3-Pentafluoro-E-prop-1-enyl)-cyclohexene epoxide

(166).

CF299B 303 (5.051)

1228800

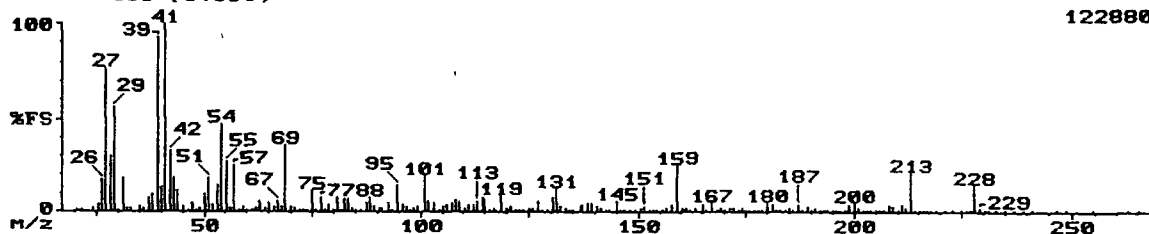

Mass	Rel Int	Mass	Rel Int	Mass	Rel Int	Mass	Rel Int
20	1.40	77	7.83	131	12.83	188	0.71
22	0.02	78	1.40	132	3.27	189	2.65
24	1.90	79	3.88	133	1.73	190	0.32
25	3.73	80	1.21	134	0.52	191	1.92
26	17.33	81	7.50	135	0.33	192	0.24
27	77.00	82	0.93	137	2.48	193	1.19
28	30.00	83	6.42	137	4.15	194	0.10
29	56.00	83	6.75	138	5.04	195	0.34
30	1.33	84	1.75	139	5.33	196	0.12
31	18.25	85	1.07	140	2.63	197	0.90
32	1.52	86	1.08	141	2.35	198	0.48
33	2.25	87	5.02	142	0.98	199	3.94
35	3.19	88	7.83	143	1.11	200	5.33
36	2.23	89	3.27	145	5.67	201	1.52
37	7.33	90	2.13	146	0.62	202	0.13
38	9.58	91	2.19	147	0.99	203	0.08
39	93.33	93	5.19	148	0.42	204	0.06
40	14.00	94	0.57	149	0.72	205	0.12
41	100.00	95	14.67	151	2.06	206	0.07
42	33.00	96	3.60	151	2.69	207	0.48
43	18.17	97	3.35	152	1.35	208	3.96
44	11.92	98	0.23	154	1.05	209	3.13
45	3.02	98	2.15	154	0.67	210	0.81
46	0.66	99	2.58	156	0.77	211	4.21
47	4.54	101	19.42	157	1.94	212	2.02
48	0.76	102	5.42	158	3.56	213	21.25
49	2.23	103	4.42	159	25.00	214	1.33
50	9.33	104	1.02	160	1.90	215	0.12
51	18.83	105	2.54	161	1.88	216	0.02
52	4.04	106	4.25	162	0.12	217	0.06
53	14.50	107	4.58	163	1.98	218	0.02
54	47.67	108	6.50	165	3.92	219	0.05
55	27.00	109	6.00	166	0.38	221	0.11
56	2.23	110	2.35	167	4.79	223	0.07
57	25.00	111	3.83	168	0.79	225	0.11
58	1.35	112	4.15	169	2.29	226	0.11
59	3.02	113	5.67	170	0.68	227	0.60
60	0.41	114	7.50	171	1.50	228	14.25
61	1.29	115	7.00	172	1.52	229	2.15
62	2.33	116	0.84	173	1.01	230	0.18
63	5.42	117	1.46	174	1.67	231	0.07
64	1.71	118	0.16	175	0.34	233	0.05
65	5.33	119	8.50	176	0.11	235	0.05
66	2.54	120	2.13	177	0.94	237	0.05
67	5.67	121	2.94	178	0.17	239	0.04
68	2.75	122	0.52	179	1.44	241	0.03
69	35.67	123	0.49	180	4.79	247	0.03
70	3.40	124	0.09	181	4.02	249	0.06
71	2.40	125	1.92	182	0.48	255	0.04
72	0.53	126	1.71	183	0.48	263	0.01
73	1.27	127	5.92	184	1.32	265	0.03
74	0.93	128	0.84	185	1.48		
75	11.58	129	0.97	186	0.50		
76	1.20	130	7.75	187	3.77		

Mass Spectrum 76: 1-(1,2,3,3,3-Pentafluoro-E-prop-1-enyl epoxide)-cyclohexene epoxide (167).

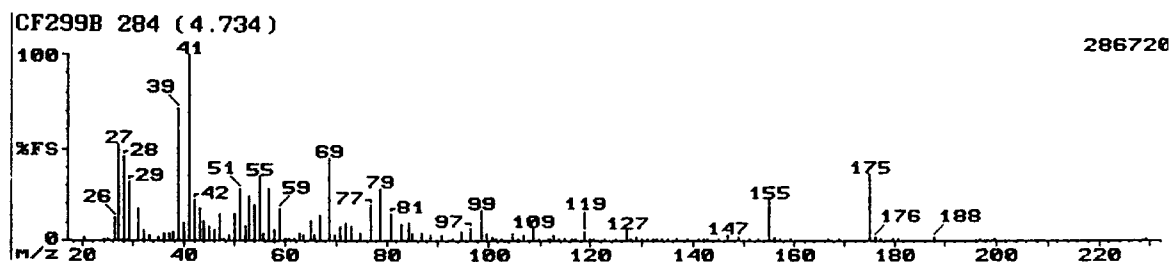

Mass	Rel Int	Mass	Rel Int	Mass	Rel Int	Mass	Rel Int
20	2.05	55	34.64	97	7.23	134	0.49
24	0.93	56	3.44	99	16.52	135	0.45
25	1.33	57	28.57	100	4.17	137	0.82
26	12.32	58	5.98	101	1.72	139	0.39
27	52.14	59	17.41	102	0.20	141	1.34
28	45.36	60	1.39	103	0.97	142	0.06
29	32.50	61	1.43	105	3.57	143	0.29
31	17.86	62	1.18	106	0.81	145	0.40
32	5.45	63	3.48	107	2.52	147	2.43
33	2.52	64	2.48	109	7.14	149	1.61
35	2.37	65	10.54	110	0.43	151	0.16
36	3.53	66	3.04	112	1.08	153	0.08
37	3.62	67	13.30	112	0.61	155	22.68
38	4.98	69	45.00	113	2.52	156	1.63
39	71.79	70	2.90	114	0.47	157	0.68
40	9.73	71	7.95	115	1.01	159	0.28
41	100.00	72	9.64	116	0.15	167	0.26
42	22.68	73	8.21	117	0.50	169	0.20
43	17.32	75	3.91	119	4.71	175	36.07
44	11.07	77	19.82	120	0.26	176	2.30
45	7.68	79	28.21	121	0.23	177	0.41
46	6.16	81	14.64	123	0.85	180	0.10
47	14.29	83	8.30	125	0.68	181	0.09
48	0.85	84	10.18	127	5.36	188	2.05
49	3.01	85	3.97	128	0.75	197	0.74
50	14.82	87	3.71	129	1.63	200	0.26
51	28.57	89	2.59	130	0.26	229	0.12
52	7.68	91	3.37	131	0.79		
53	24.64	93	0.89	132	0.21		
54	19.64	95	4.51	133	1.24		

Appendix C: IR Spectra.

Appendix C.i.: IR Spectra for Chapter 2.

IR Spectrum 1: 1-(1,1,2,3,3,3-Hexafluoropropyl)-cyclohexanol (**46**).

IR Spectrum 2: 1-(1,1,2,3,3,3-Hexafluoropropyl)-cyclobutanol (**52**).

IR Spectrum 3: 1-(1,1,2,3,3,3-Hexafluoropropyl)-cyclopentanol (**54**).

IR Spectrum 4: 1-(1,1,2,3,3,3-Hexafluoropropyl)-cycloheptanol (**56**).

IR Spectrum 5: 1-(1,1,2,3,3,3-Hexafluoropropyl)-cyclooctanol (**61**).

IR Spectrum 1: 1-(1,1,2,3,3,3-Hexafluoropropyl)-cyclohexanol (46).

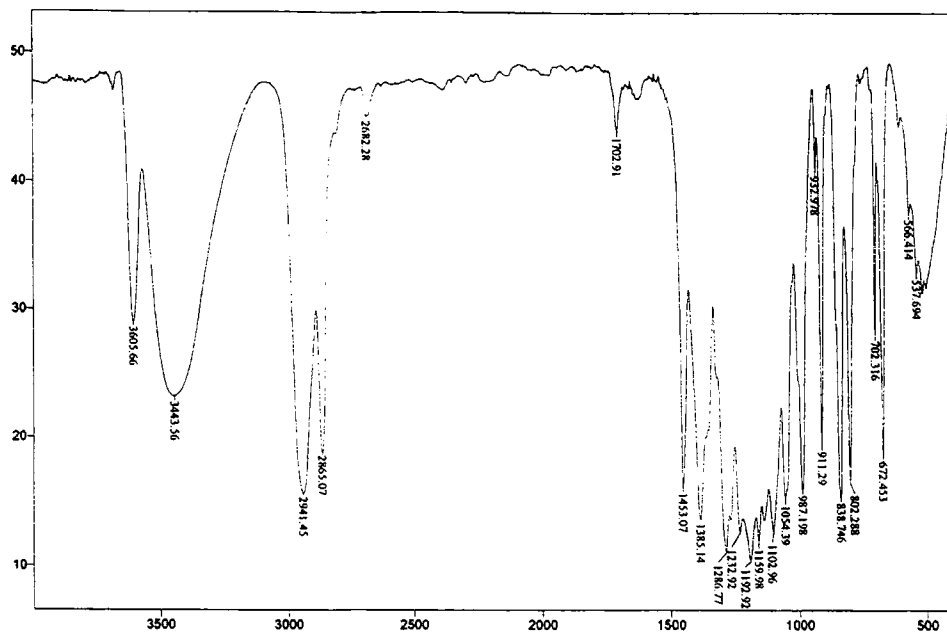

IR Spectrum 2: 1-(1,1,2,3,3,3-Hexafluoropropyl)-cyclobutanol (52).

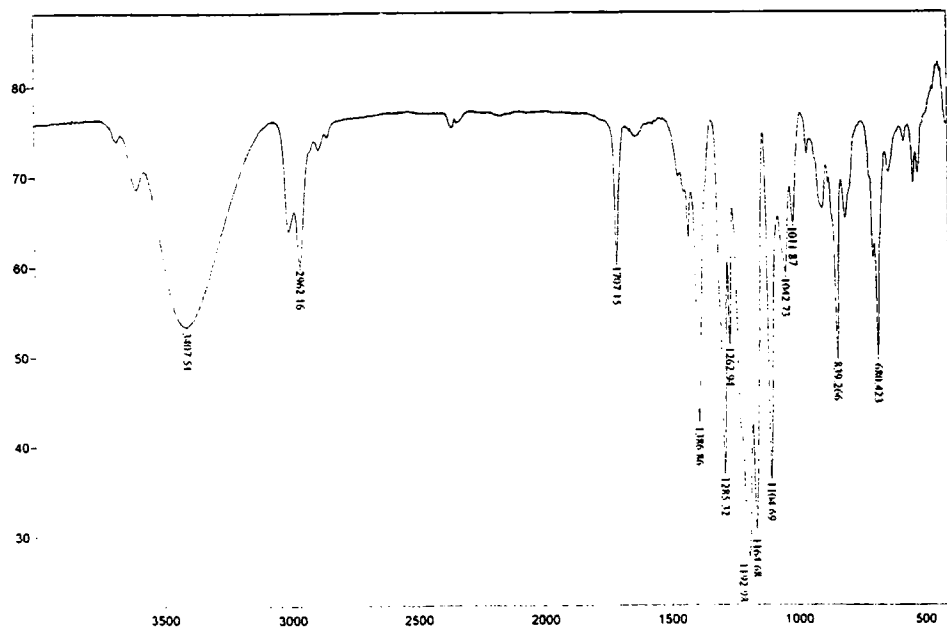

IR Spectrum 3: 1-(1,1,2,3,3,3-Hexafluoropropyl)-cyclopentanol (**54**).

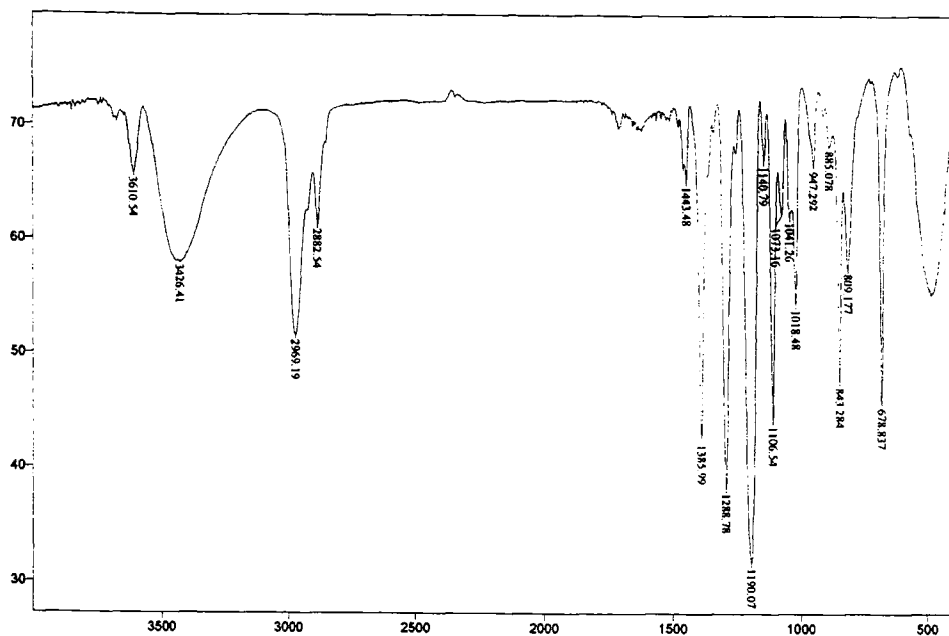

IR Spectrum 4: 1-(1,1,2,3,3,3-Hexafluoropropyl)-cycloheptanol (**56**).

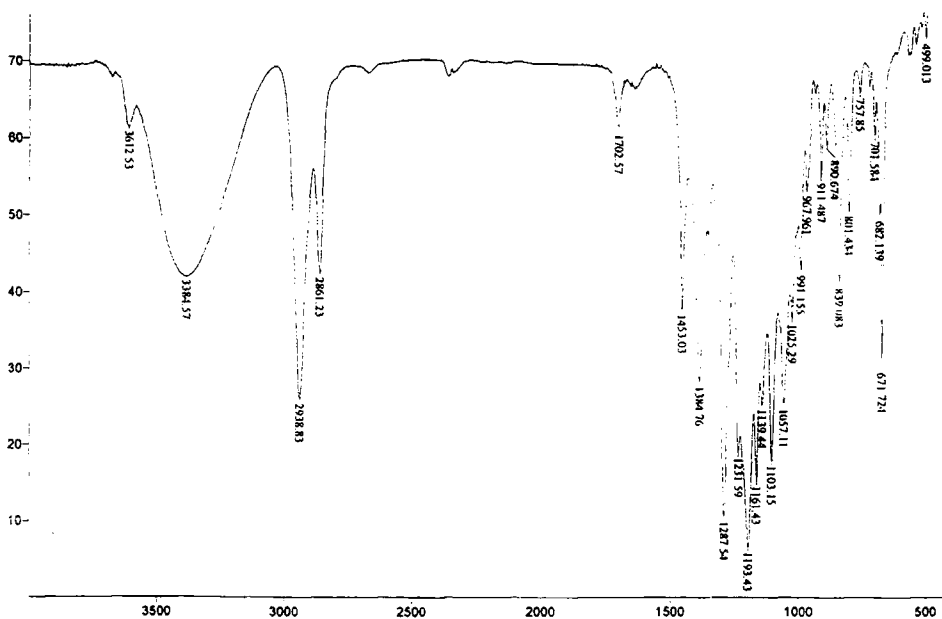

IR Spectrum 5: 1-(1,1,2,3,3,3-Hexafluoropropyl)-cyclooctanol (**61**).

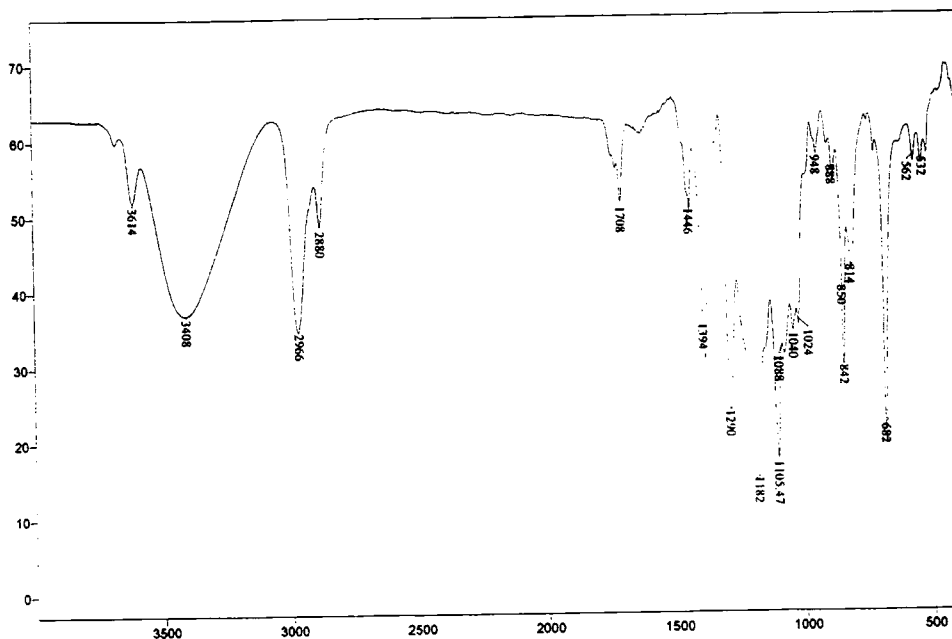

Appendix C.ii.: IR Spectra for Chapter 3.

IR Spectrum 6: 1-(1,1,2,3,3,3-Hexafluoropropyl)-4-methylcyclohexanol (**68**).

IR Spectrum 7: 1-(1,1,2,3,3,3-Hexafluoropropyl)-4-tert-butylcyclohexanol
(**71**).

IR Spectrum 8: 2-(2,2,3,4,4,4-Hexafluorobutyl)-1-(1,1,2,3,3,3-hexafluoropropyl)-cyclohexanol (**73**).

IR Spectrum 9: *Exo*-2-(1,1,2,3,3,3-hexafluoropropyl)-norbornan-2-ol (**77**).

IR Spectrum 6: 1-(1,1,2,3,3,3-Hexafluoropropyl)-4-methylcyclohexanol (**68**).

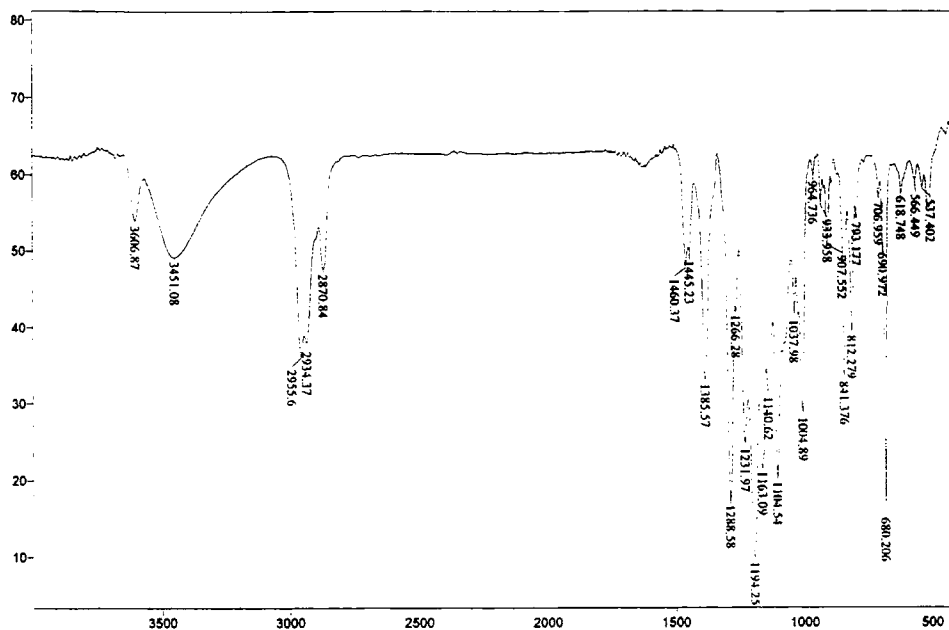

IR Spectrum 7: 1-(1,1,2,3,3,3-Hexafluoropropyl)-4-tert-butylcyclohexanol (**71**).

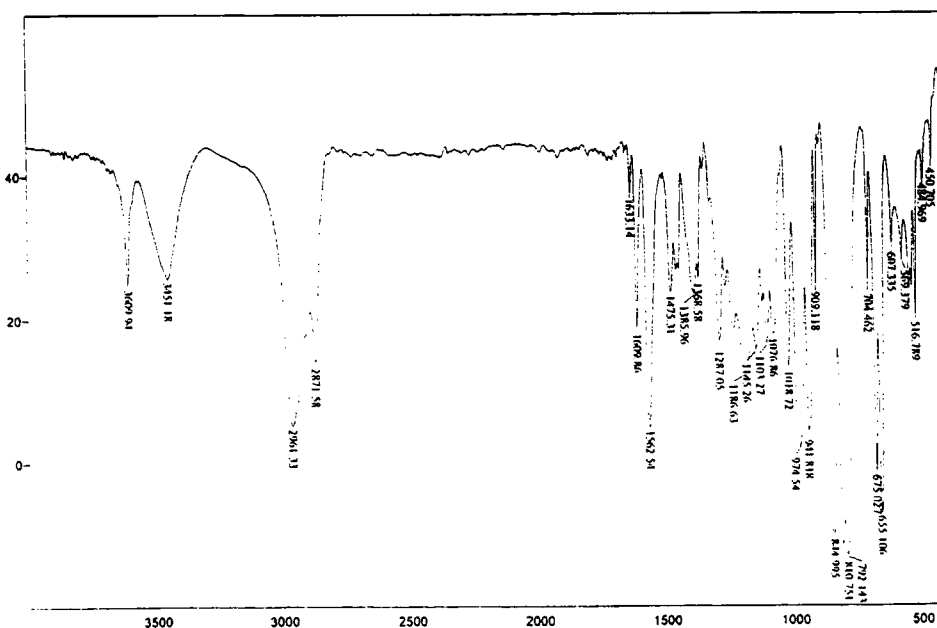

Mass Spectrum 8: 2-(2,2,3,4,4,4-Hexafluorobutyl)-1-(1,1,2,3,3,3-hexafluoropropyl)-cyclohexanol (73).

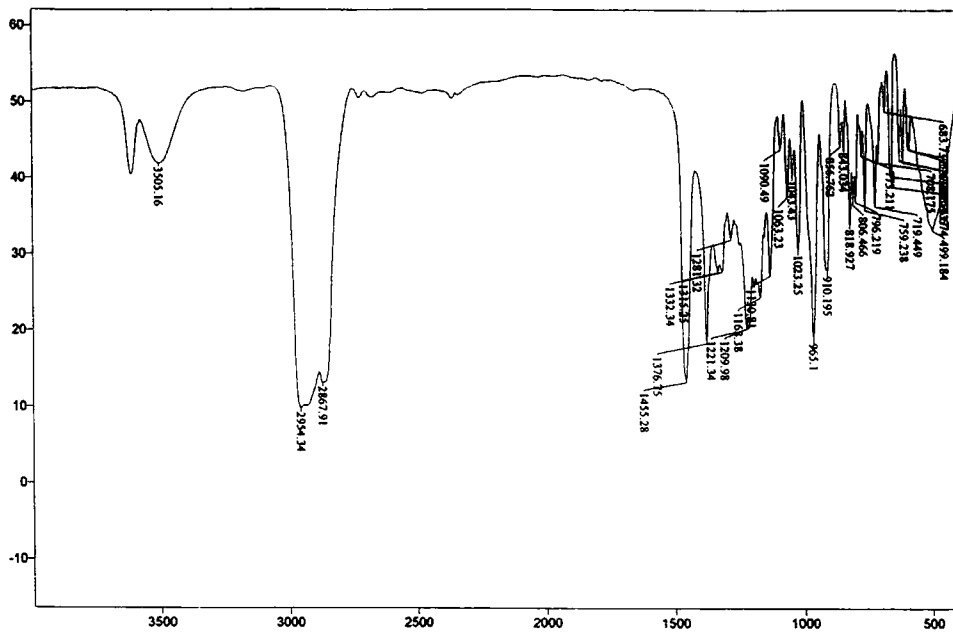

Mass Spectrum 9: *Exo*-2-(1,1,2,3,3,3-hexafluoropropyl)-norbornan-2-ol (77).

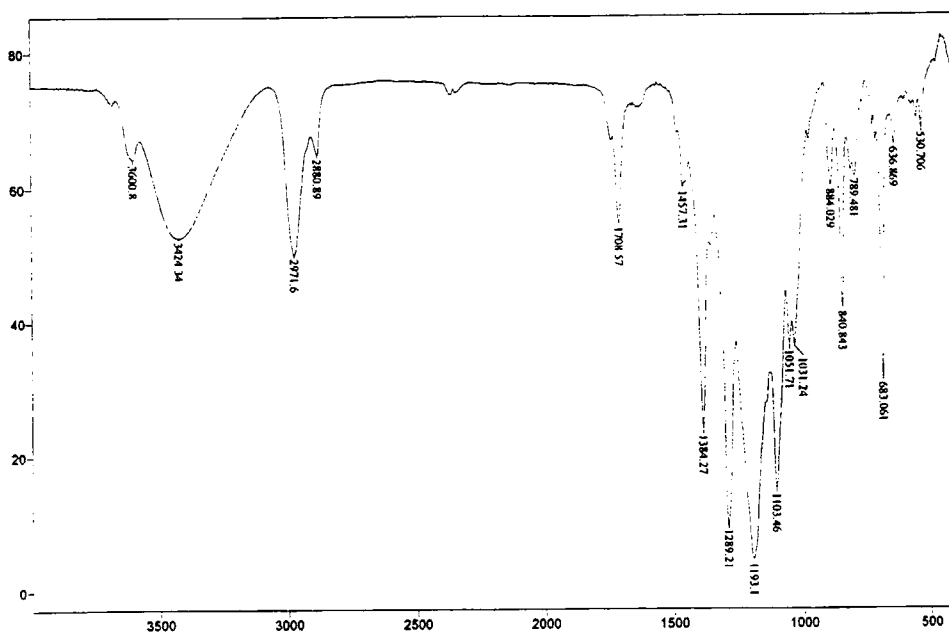

Appendix C.iii.: IR Spectra for Chapter 4.

Mass Spectrum 10: 1,4-Di-(1,1,2,3,3,3-hexafluoropropyl)-cyclohexane-1,4-diol (**85**).

Mass Spectrum 11: 1-(1,1,2,3,3,3-Hexafluoropropyl)-cyclohexane-1,3-diol (**87**).

Mass Spectrum 12: 1,3-Di-(1,1,2,3,3,3-hexafluoropropyl)-cyclohexane-1,3-diol (**88**).

Mass Spectrum 13: 1,3-Di-(1,1,2,3,3,3-hexafluoropropyl)-cyclopentane-1,3-diol (**92**).

Mass Spectrum 14: 4,6-Dimethyl-1,1,1,2,3,3,7,7,8,9,9,9-dodecafluorononane-4,6-diol (**94**).

Mass Spectrum 15: 4,7-Dimethyl-1,1,1,2,3,3,8,8,9,10,10,10-dodecafluorodecane-4,7-diol (**97**).

Mass Spectrum 16: 1,1,1,2,3,3,7,7,8,9,9,9-Dodecafluorodecane-4,6-diol (**100**).

Mass Spectrum 17: 1-(2-Hydro-perfluorocyclopentyl)-cyclopentan-1-ol (**114**).

Mass Spectrum 18: 1-(2-Hydro-perfluorocyclohexyl)-cyclopentan-1-ol (**115**).

Mass Spectrum 19: 1-(2-Hydro-perfluorocyclohexyl)-cyclohexan-1-ol (**116**).

IR Spectrum 10: 1,4-Di-(1,1,2,3,3,3-hexafluoropropyl)-cyclohexane-1,4-diol (**85**).

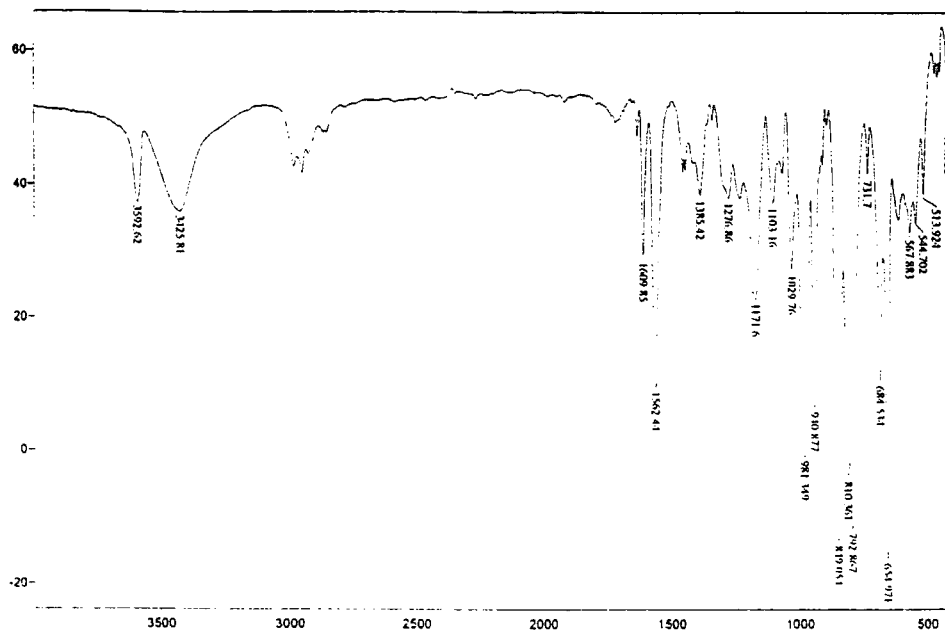

IR Spectrum 11: 1-(1,1,2,3,3,3-Hexafluoropropyl)-cyclohexane-1,3-diol (**87**).

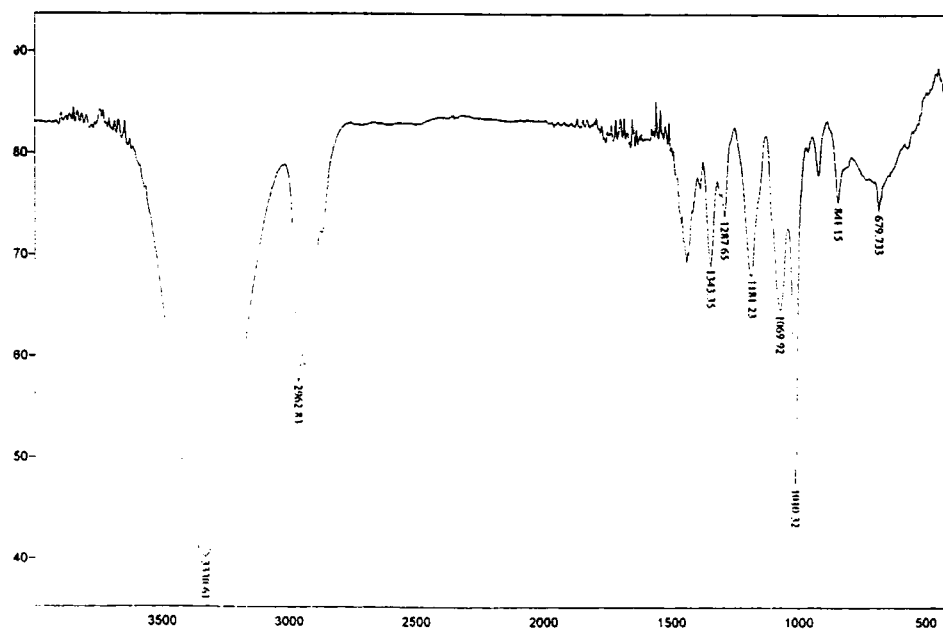

IR Spectrum 12: 1,3-Di-(1,1,2,3,3,3-hexafluoropropyl)-cyclohexane-1,3-diol (**88**).

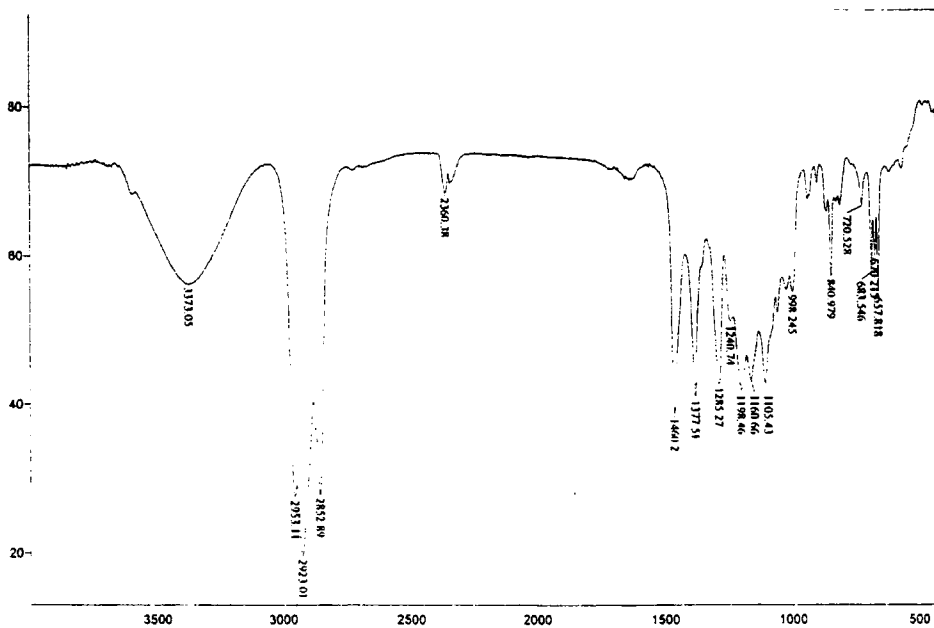

IR Spectrum 13: 1,3-Di-(1,1,2,3,3,3-hexafluoropropyl)-cyclopentane-1,3-diol (**92**).

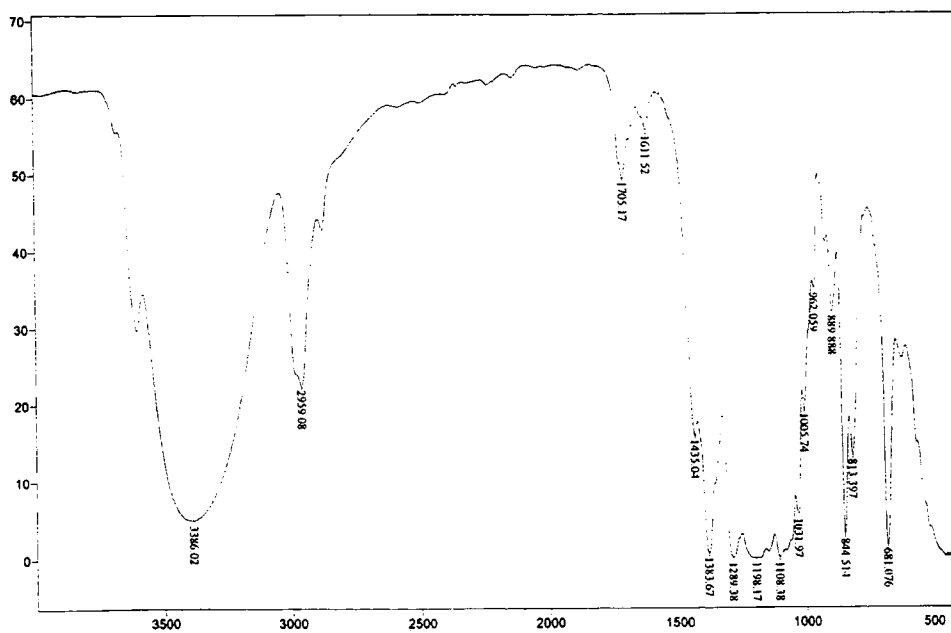

IR Spectrum 14: 4,6-Dimethyl-1,1,1,2,3,3,7,7,8,9,9,9-dodecafluorononane-4,6-diol
(94).

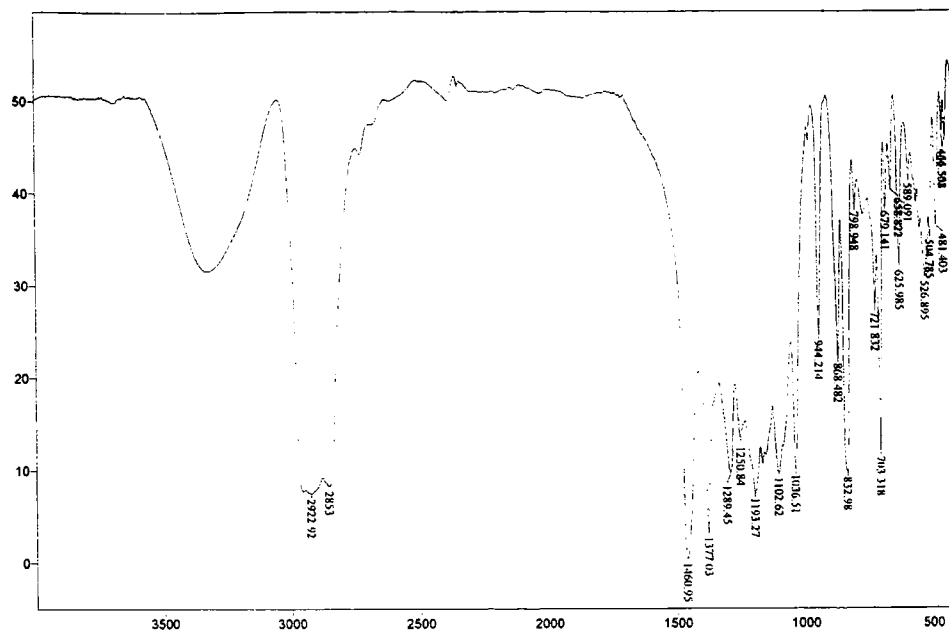

IR Spectrum 15: 4,7-Dimethyl-1,1,1,2,3,3,8,8,9,10,10,10-dodecafluorodecane-4,7-diol
(97).

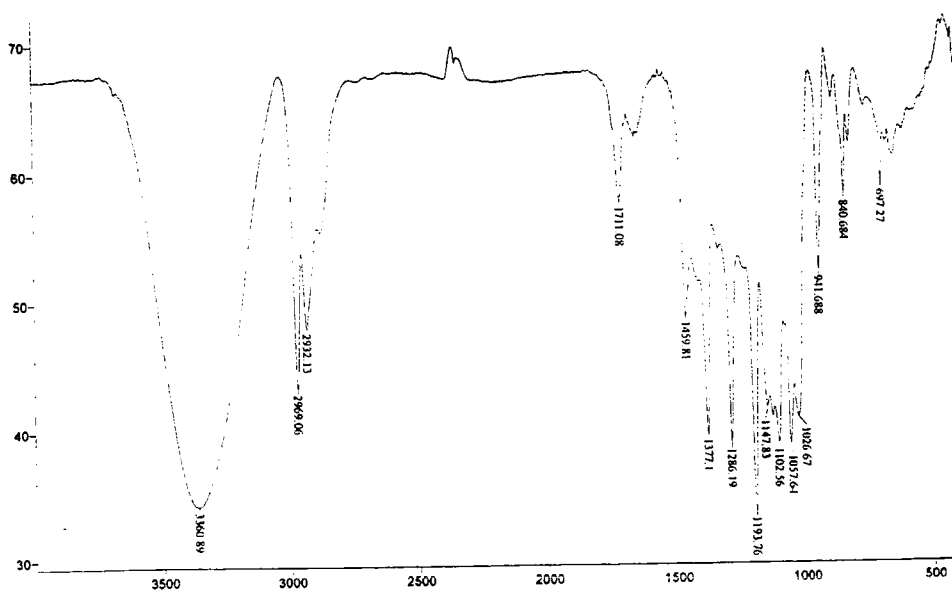

IR Spectrum 16: 1,1,1,2,3,3,3,7,7,8,9,9,9-Dodecafluorodecane-4,6-diol (100).

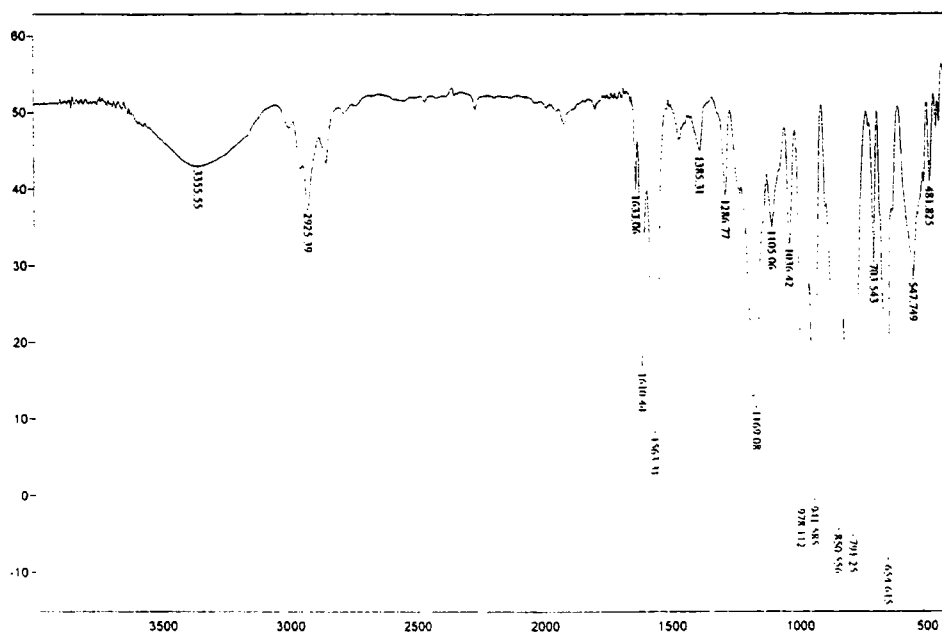

IR Spectrum 17: 1-(2-Hydro-perfluorocyclopentyl)-cyclopentan-1-ol (114).

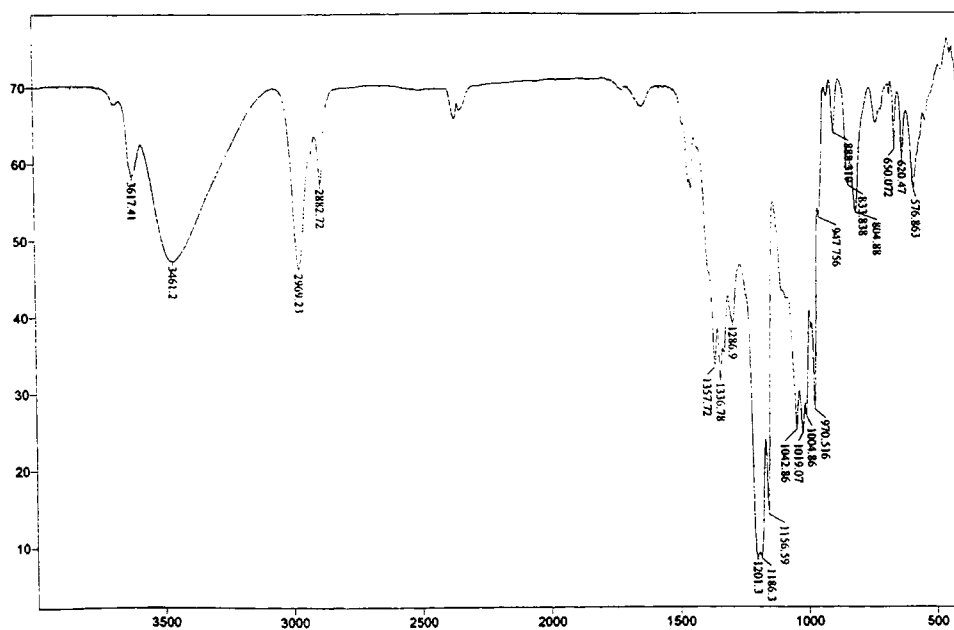

IR Spectrum 18: 1-(2-Hydro-perfluorocyclohexyl)-cyclopentan-1-ol (115).

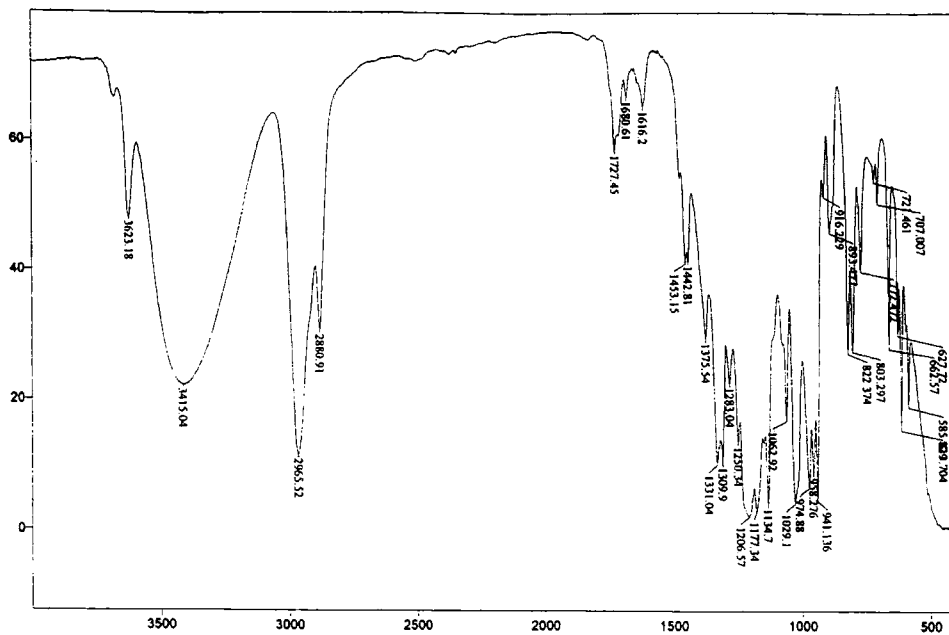

IR Spectrum 19: 1-(2-Hydro-perfluorocyclohexyl)-cyclohexan-1-ol (116).

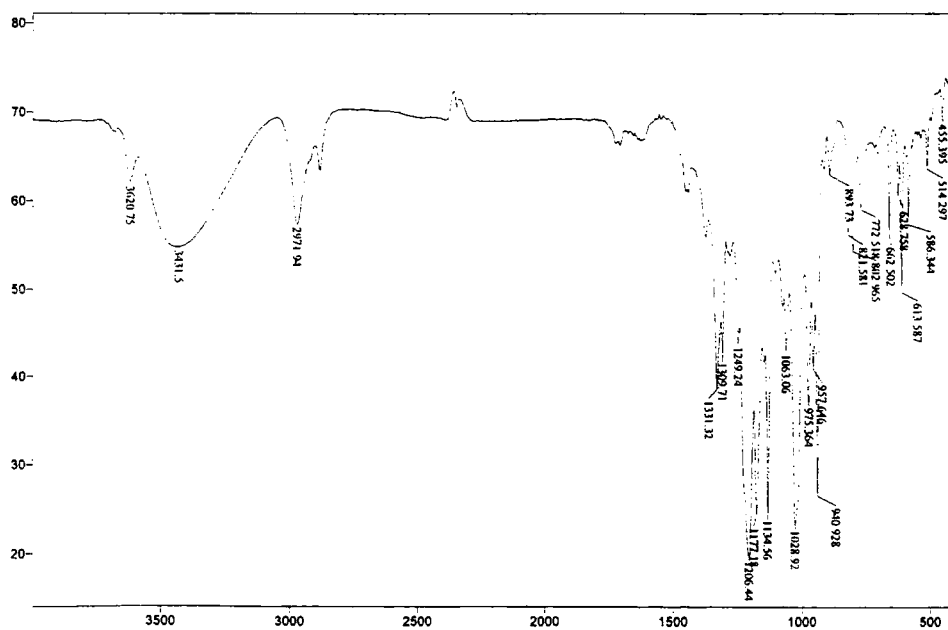

Appendix C.iv.: IR Spectra for Chapter 5.

IR Spectrum 20: 1-(1,2,3,3,3-Pentafluoro-E-prop-1-enyl)-cyclohexanol (123).

IR Spectrum 21: 1-(1,2,3,3,3-Pentafluoro-E-prop-1-enyl)-cyclopentanol (124).

IR Spectrum 22: 1-(1,1,2,3,3,3-Hexafluoropropyl)-cyclopentyl acetate (126).

IR Spectrum 23: 1,1,1,2,3,3,7,7,8,9,9,9-Dodecafluoro-4,6-dimethylnonane-4,6-diacetate (127).

IR Spectrum 24: 1-(1,1,2,3,3,3-Hexafluoropropyl)-cyclopentyl benzoate (129).

IR Spectrum 25: (1-(1,1,2,3,3,3-Hexafluoropropyl)-cyclopentoxy)-trimethyl silane (140).

IR Spectrum 26: 1-(1,1,2,3,3,3-Hexafluoropropyl)-cyclohexene (142).

IR Spectrum 27: 1-(1,1,2,3,3,3-Hexafluoropropyl)-cyclopentene (143).

IR Spectrum 28: 1-(1,1,2,3,3,3-Hexafluoropropyl)-cycloheptene (144).

IR Spectrum 29: 1-(1,1,2,3,3,3-Hexafluoropropyl)-norbornene (145).

IR Spectrum 30: 1-(2-Hydro-perfluorocyclopentyl)-cyclopentene (146).

IR Spectrum 31: 1-(2-Hydro-perfluorocyclohexyl)-cyclohexene (147).

IR Spectrum 32: 1,x-Di-(1,1,2,3,3,3-hexafluoropropyl)-cyclopentadiene (x=3,4) (148).

IR Spectrum 33: 1-(1,1,2,3,3,3-Hexafluoropropyl)-1,2-dibromocyclohexane (149).

IR Spectrum 34: 1-(1,1,2,3,3,3-Hexafluoropropyl)-1,2-dibromocyclopentane (150).

IR Spectrum 35: 1-(1,1,2,3,3,3-Hexafluoropropyl)-5-bromocyclopentene (151).

IR Spectrum 36: 1-(1,1,2,3,3,3-Hexafluoropropyl)-cyclopentene epoxide (152).

IR Spectrum 37: 1-(1,1,2,3,3,3-Hexafluoropropyl)-cyclohexene epoxide (153).

IR Spectrum 38: 1-(1,1,2,3,3,3-Hexafluoropropyl)-cyclohexane-1,2-diol (154).

IR Spectrum 39: 3,6-Dibromo-(1,1,2,3,3,3-hexafluoropropyl)-cyclohexene (155).

IR Spectrum 40: 1-(1,2,3,3,3-Pentafluoro-Z-prop-1-enyl)-cyclopentene (159).

IR Spectrum 41: 1-(1,2,3,3,3-Pentafluoro-Z-prop-1-enyl)-cyclohexene (160).

IR Spectrum 42: 1-(1,2,3,3,3-Pentafluoro-E-prop-1-enyl)-cyclohexene epoxide (166).

IR Spectrum 20: 1-(1,2,3,3,3-Pentafluoro-E-prop-1-enyl)-cyclohexanol (**123**).

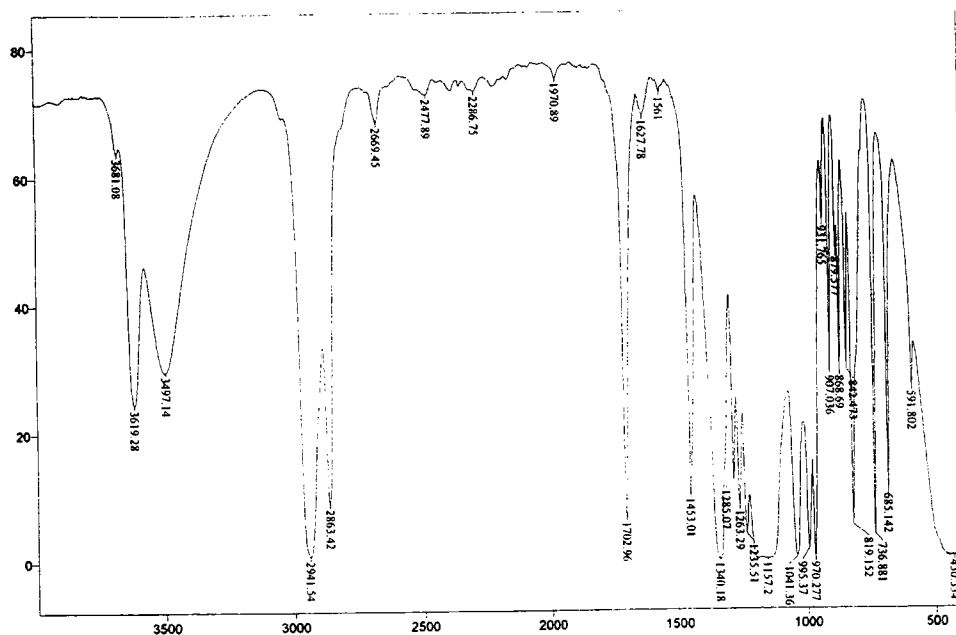

IR Spectrum 21: 1-(1,2,3,3,3-Pentafluoro-E-prop-1-enyl)-cyclopentanol (**124**).

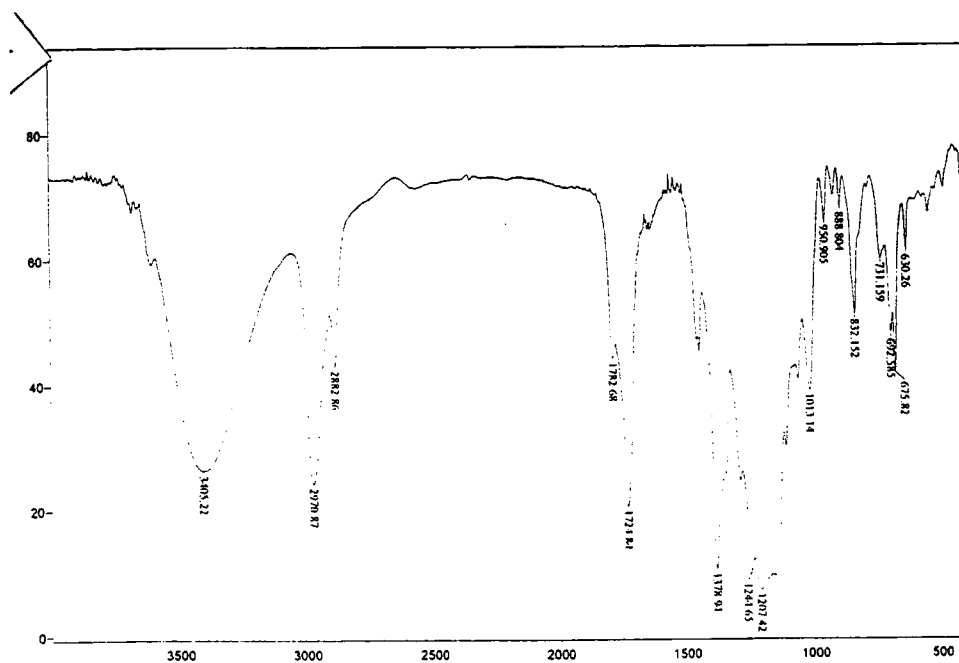

IR Spectrum 22: 1-(1,1,2,3,3,3-Hexafluoropropyl)-cyclopentyl acetate (126).

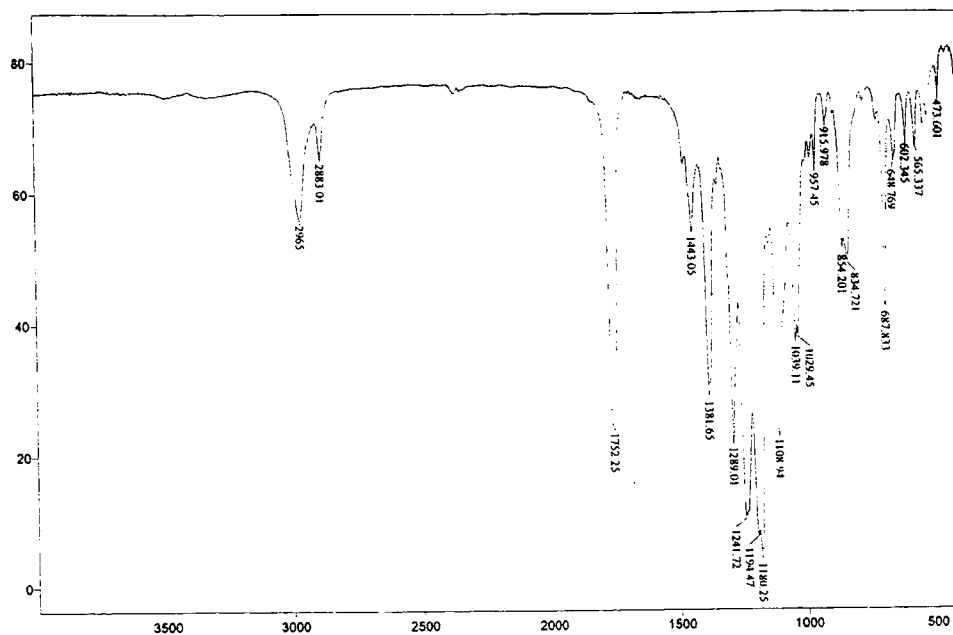

IR Spectrum 23: 1,1,1,2,3,3,7,7,8,9,9,9-Dodecafluoro-4,6-dimethylnonane-4,6-diacetate (127).

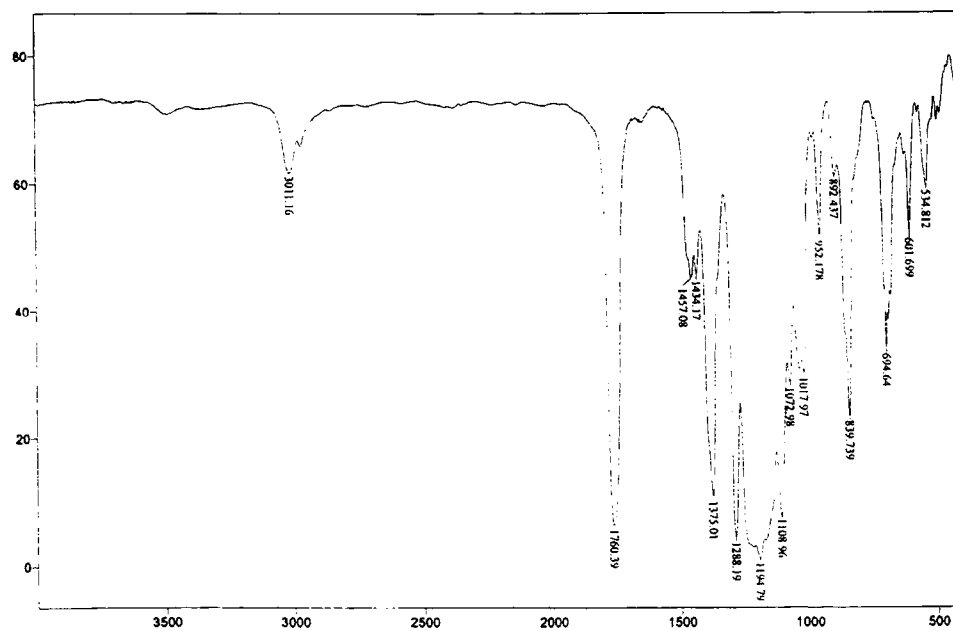

IR Spectrum 24: 1-(1,1,2,3,3,3-Hexafluoropropyl)-cyclopentyl benzoate (129).

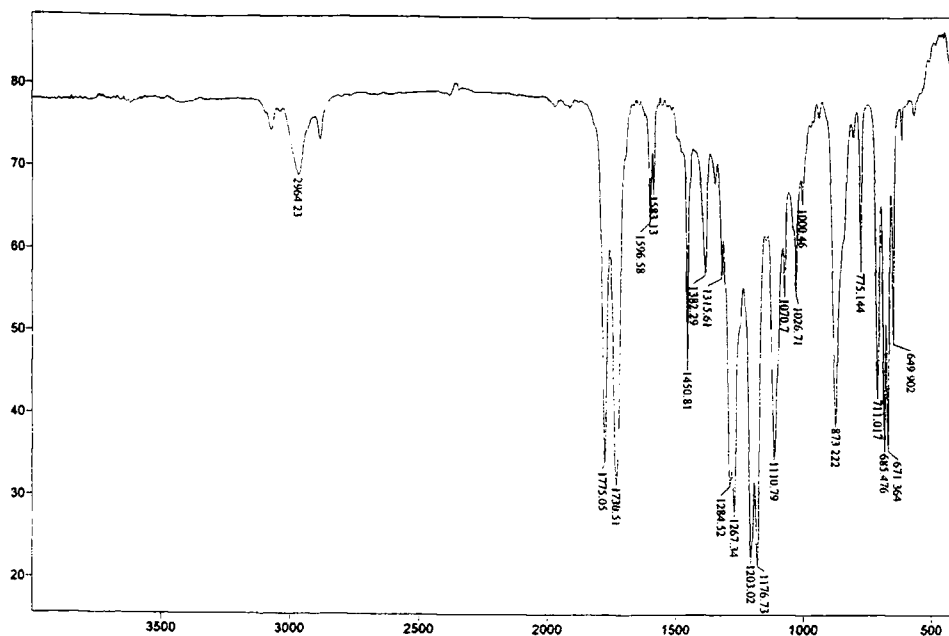

IR Spectrum 25: (1-(1,1,2,3,3,3-Hexafluoropropyl)-cyclopentoxy)-trimethyl silane (140).

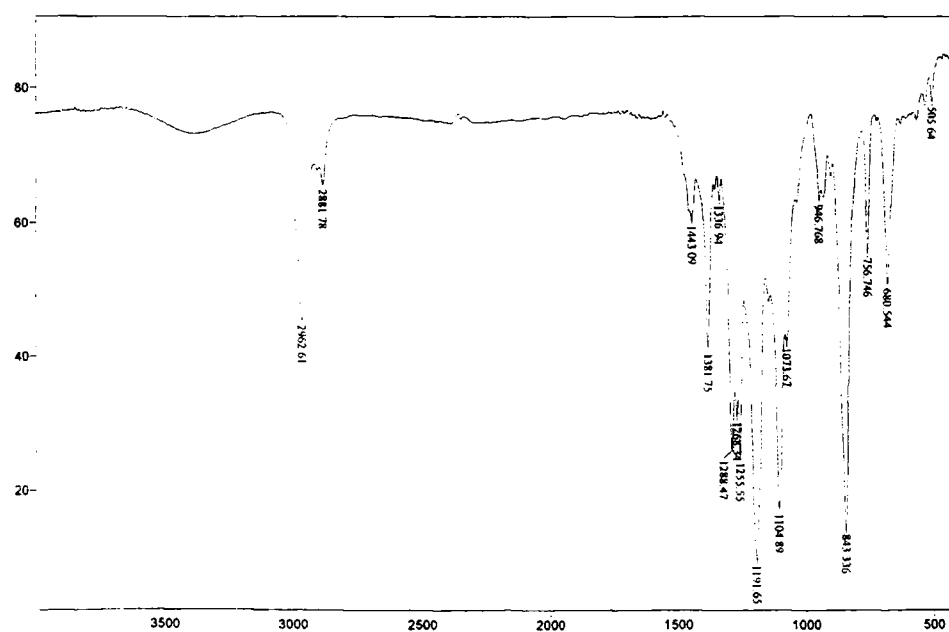

IR Spectrum 26: 1-(1,1,2,3,3,3-Hexafluoropropyl)-cyclohexene (**142**).

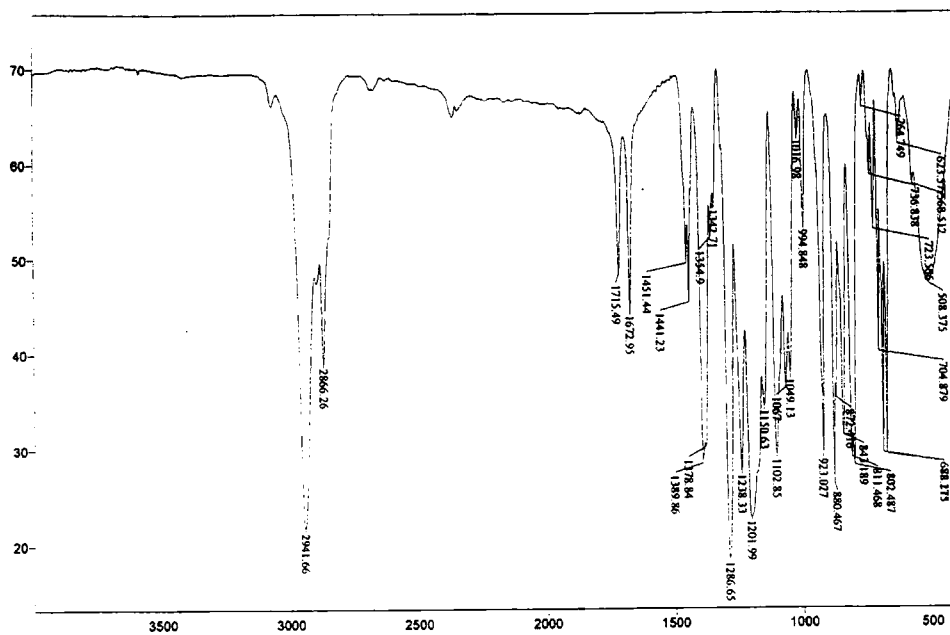

IR Spectrum 27: 1-(1,1,2,3,3,3-Hexafluoropropyl)-cyclopentene (**143**).

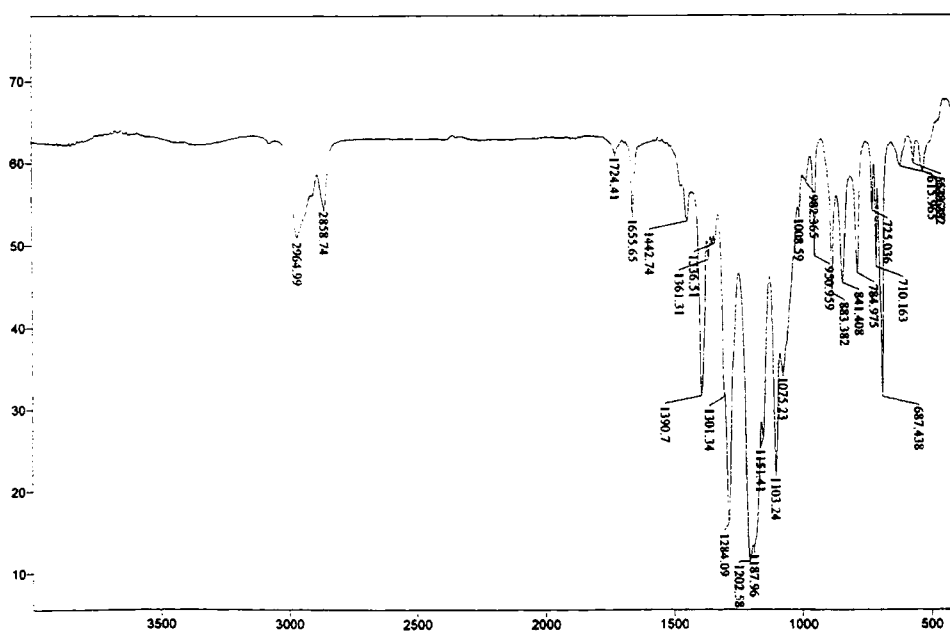

IR Spectrum 28: 1-(1,1,2,3,3,3-Hexafluoropropyl)-cycloheptene (144).

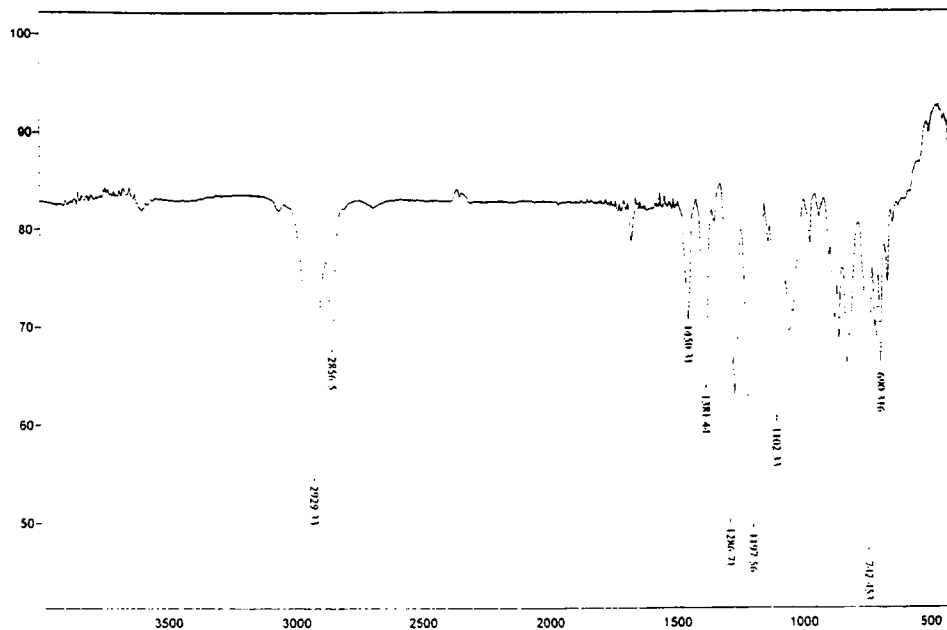

IR Spectrum 29: 1-(1,1,2,3,3,3-Hexafluoropropyl)-norbornene (145).

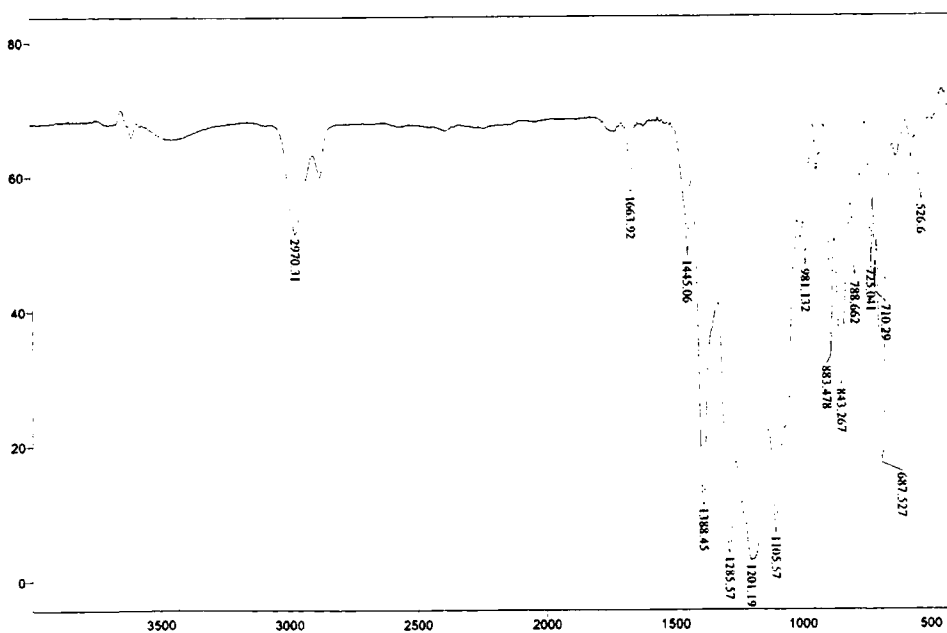

IR Spectrum 30: 1-(2-Hydro-perfluorocyclopentyl)-cyclopentene (146).

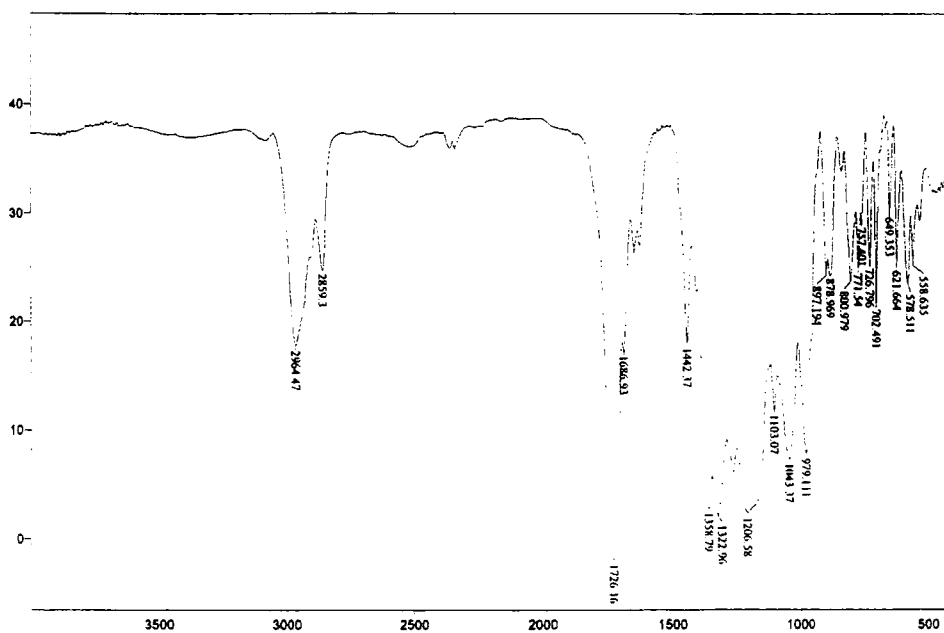

IR Spectrum 31: 1-(1,1,2,3,3,3-Hexafluoropropyl)-1,2-dibromocyclohexane (149).

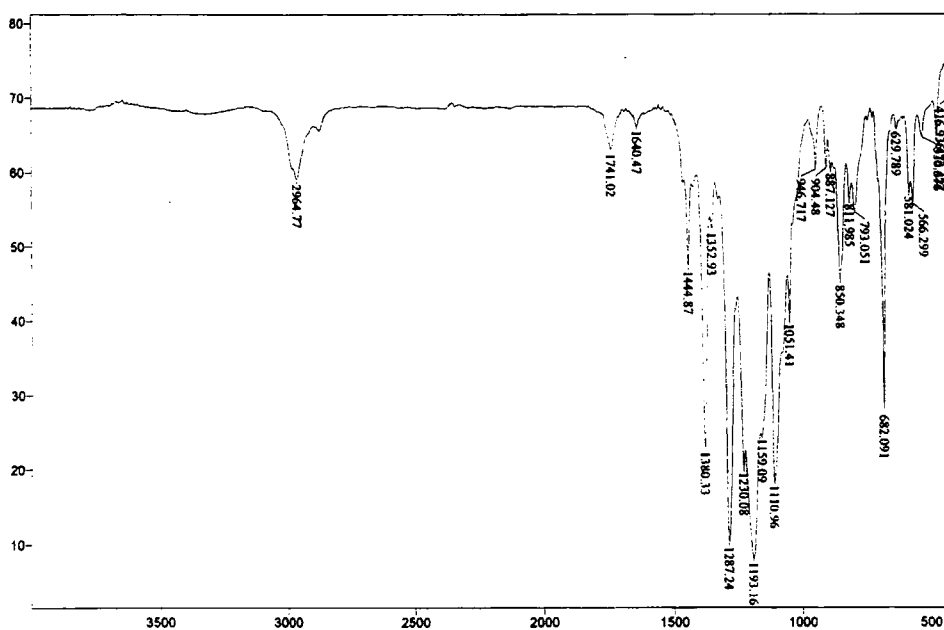

IR Spectrum 32: 1-(1,1,2,3,3,3-Hexafluoropropyl)-1,2-dibromocyclopentane (150).

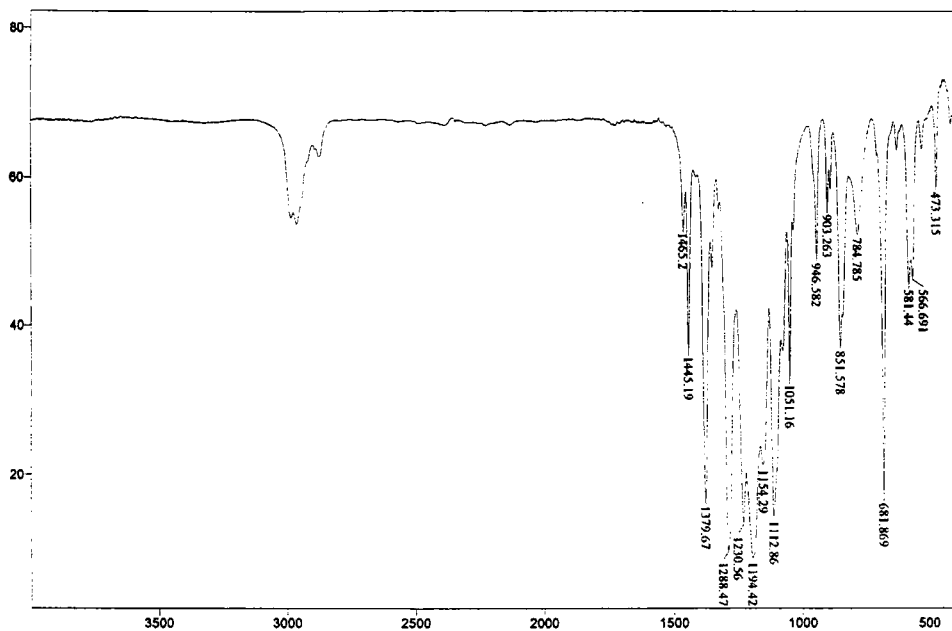

IR Spectrum 33: 1-(1,1,2,3,3,3-Hexafluoropropyl)-5-bromocyclopentene (151).

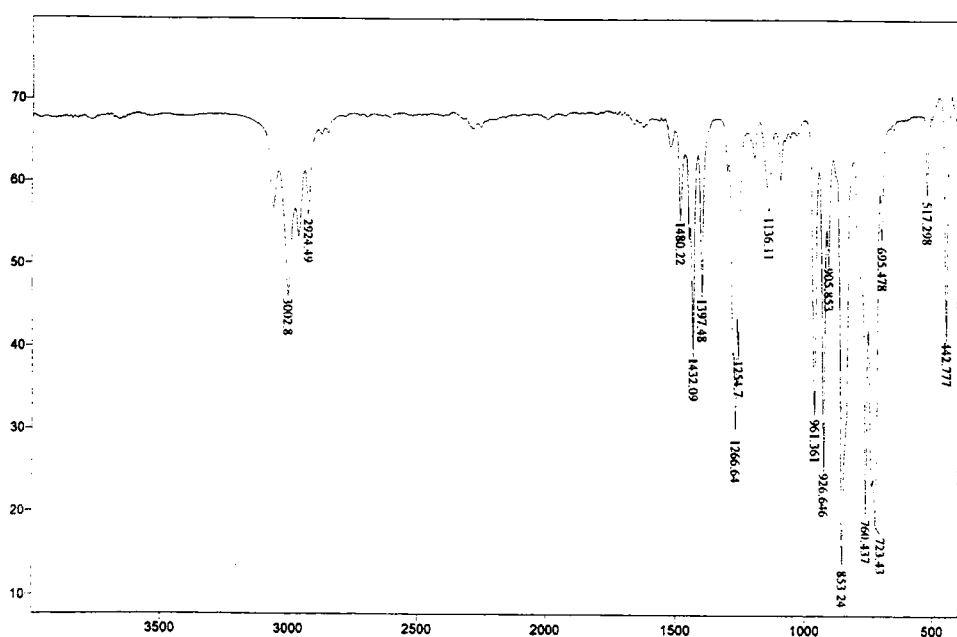

IR Spectrum 34: 1-(1,1,2,3,3,3-Hexafluoropropyl)-cyclopentene epoxide (**152**).

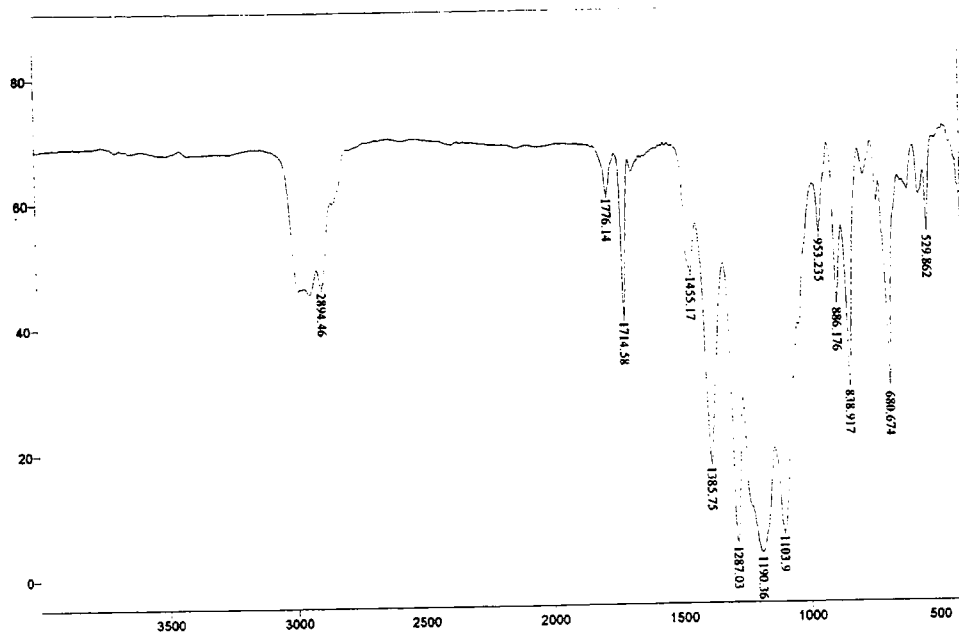

IR Spectrum 35: 1-(1,1,2,3,3,3-Hexafluoropropyl)-cyclohexene epoxide (**153**).

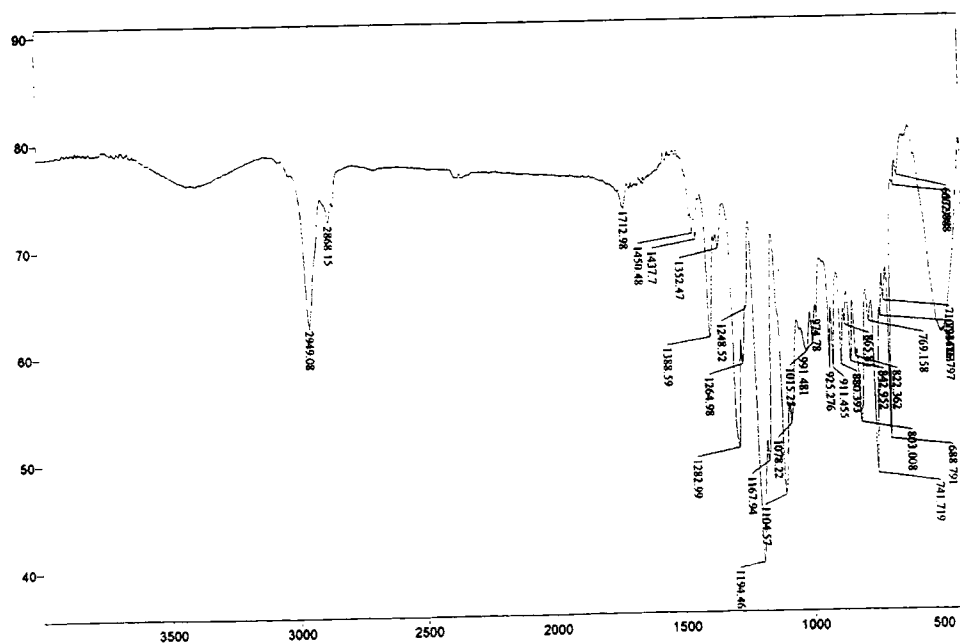

IR Spectrum 36: 1-(1,1,2,3,3,3-Hexafluoropropyl)-cyclohexane-1,2-diol (154).

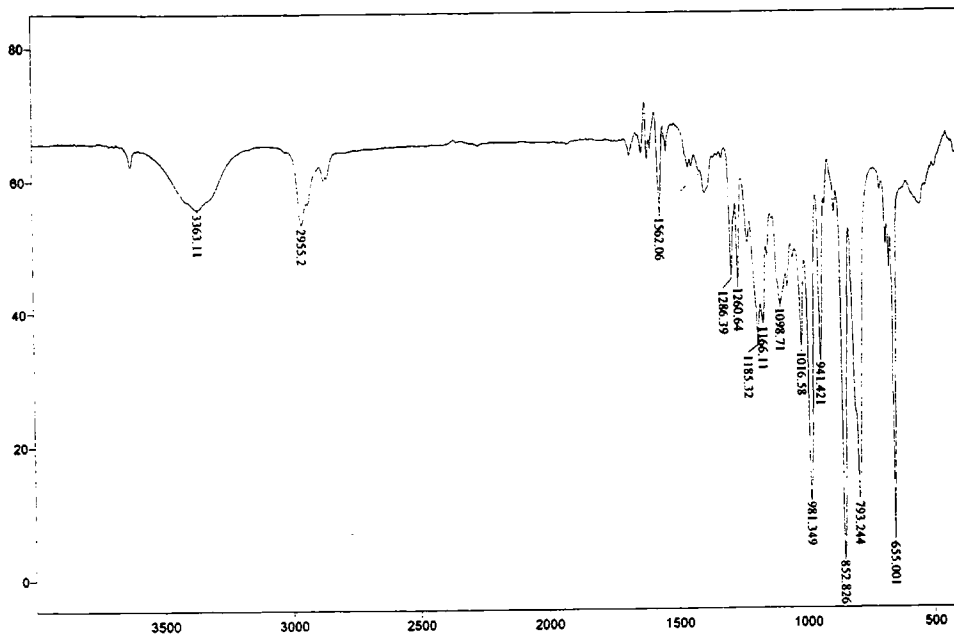

IR Spectrum 37: 3,6-Dibromo-(1,1,2,3,3,3-hexafluoropropyl)-cyclohexene (155).

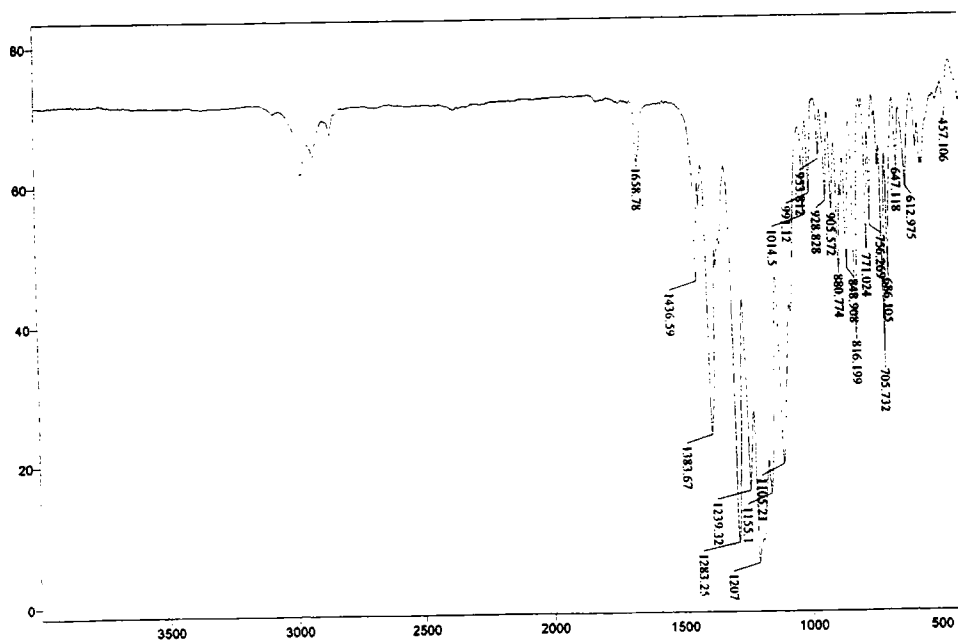

IR Spectrum 38: 1-(1,2,3,3,3-Pentafluoro-Z-prop-1-enyl)-cyclopentene (159).

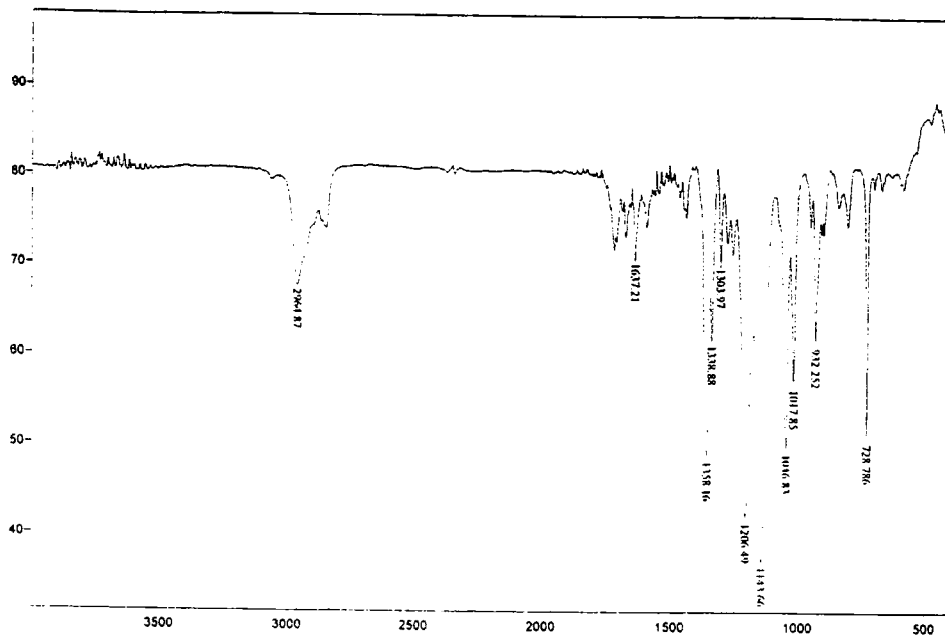

IR Spectrum 39: 1-(1,2,3,3,3-Pentafluoro-Z-prop-1-enyl)-cyclohexene (160).

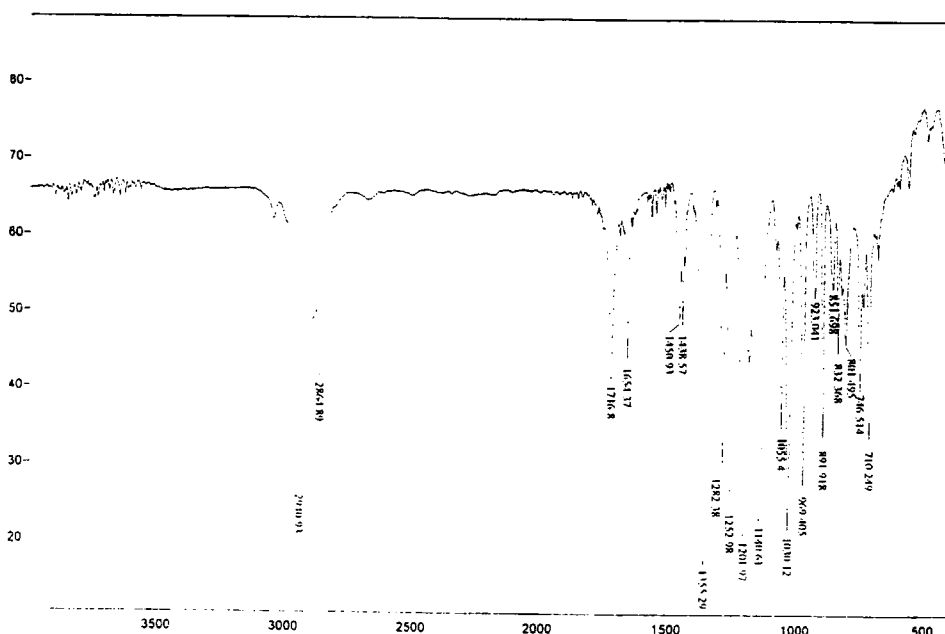

IR Spectrum 40: 1-(1,2,3,3,3-Pentafluoro-E-prop-1-enyl)-cyclohexene epoxide (166).

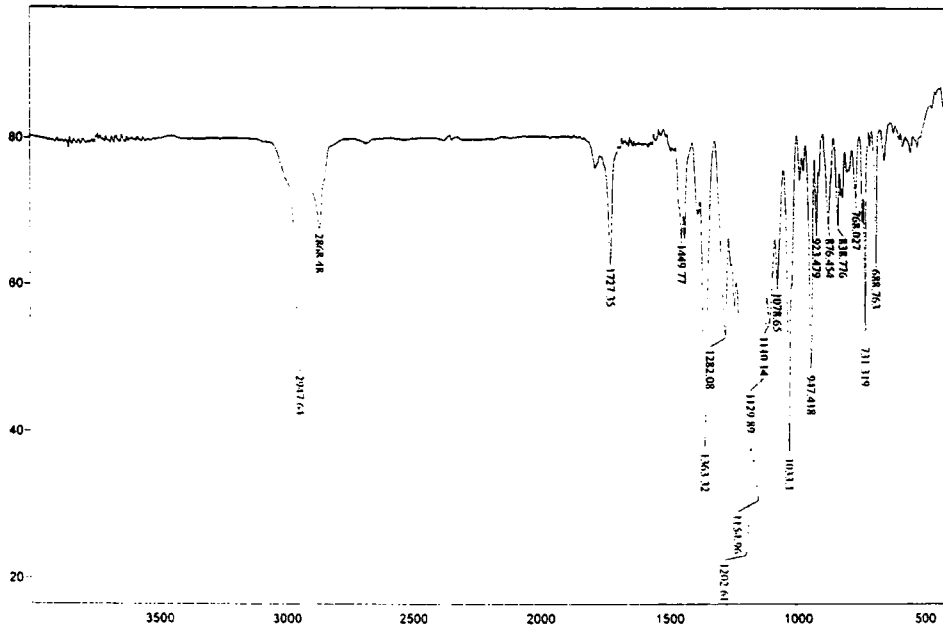

Appendix D: X-Ray Crystal Structures.

Appendix B.i.:X-Ray Crystal Structures.

X-Ray Crystal Structure 1: 1,4-Di-(1,1,2,3,3,3-hexafluoropropyl)-4-methylcyclohexanol (**69**).

X-Ray Crystal Structure 2: 1-(1,1,2,3,3,3-Hexafluoropropyl)-4-*tert*-butylcyclohexanol (**71a**).

X-Ray Crystal Structure 3: 1,3-Di-(1,1,2,3,3,3-hexafluoropropyl)-cyclohexane-1,3-diol (**88**).

X-Ray Crystal Structure 4: 1,3-Di-(1,1,2,3,3,3-hexafluoropropyl)-cyclopentane-1,3-diol (**92**).

X-Ray Crystal Structure 1: 1,4-Di-(1,1,2,3,3,3-hexafluoropropyl)-4-methylcyclohexanol (69).

Identification code	cs
Empirical formula	C9.75 H10.50 F9 O0.75
Formula weight	310.68
Temperature	120(1) K
Wavelength	0.71073 A
Crystal system	Monoclinic
Space group	Cc
Unit cell dimensions	a = 11.9808(2) A alpha = 90 deg. b = 26.5786(4) A beta = 93.98(1) deg. c = 39.2700(5) A gamma = 90 deg.
Volume	12474.7(4) A ³
Z	32
Density (calculated)	1.323 Mg/m ³
Absorption coefficient	0.156 mm ⁻¹
F(000)	4992
Crystal size	0.50 x 0.22 x 0.14 mm
Theta range for data collection	1.04 to 25.00 deg.
Index ranges	-16<=h<=14, -37<=k<=37, -56<=l<=53
Reflections collected	59269
Independent reflections	21442 [R(int) = 0.0639]
Absorption correction	Multi-scan
Max. and min. transmission	1.00 and 0.68
Refinement method	Full-matrix-block least-squares on F ²
Data / restraints / parameters	21031 / 2 / 1861
Goodness-of-fit on F ²	1.019
Final R indices [I>2sigma(I)]	R1 = 0.0924, wR2 = 0.2317
R indices (all data)	R1 = 0.1337, wR2 = 0.2746
Absolute structure parameter	0.8(8)
Largest diff. peak and hole	1.274 and -0.498 e.A ⁻³

Table. Bond lengths [Å] and angles [°] for one of the independent molecules in structure CS.

O(2)-C(201)	1.436(9)	F(209)-C(212)	1.32(2)	C(204)-C(205)	1.50(1)
F(201)-C(209)	1.29(1)	F(210)-C(213)	1.38(2)	C(204)-C(210)	1.52(1)
F(202)-C(209)	1.31(1)	F(211)-C(213)	1.25(2)	C(204)-C(211)	1.56(1)
F(203)-C(209)	1.34(11)	F(212)-C(213)	1.32(2)	C(205)-C(206)	1.52(1)
F(204)-C(208)	1.41(1)	C(201)-C(206)	1.52(1)	C(207)-C(208)	1.54(1)
F(205)-C(207)	1.362(9)	C(201)-C(202)	1.54(1)	C(208)-C(209)	1.50(1)
F(206)-C(207)	1.361(9)	C(201)-C(207)	1.57(1)	C(211)-C(212)	1.50(2)
F(207)-C(211)	1.39(1)	C(202)-C(203)	1.55(1)	C(212)-C(213)	1.55(2)
F(208)-C(211)	1.48(1)	C(203)-C(204)	1.56(1)		

O(2)-C(201)-C(206)	108.5(6)	F(204)-C(208)-C(207)	109.2(7)
O(2)-C(201)-C(202)	111.7(6)	C(209)-C(208)-C(207)	116.5(8)
C(206)-C(201)-C(202)	111.8(7)	F(201)-C(209)-F(202)	111.3(9)
O(2)-C(201)-C(207)	106.4(6)	F(201)-C(209)-F(203)	103(1)
C(206)-C(201)-C(207)	111.9(6)	F(202)-C(209)-F(203)	103.7(9)
C(202)-C(201)-C(207)	106.3(6)	F(201)-C(209)-C(208)	115.2(9)
C(201)-C(202)-C(203)	109.9(6)	F(202)-C(209)-C(208)	114(1)
C(202)-C(203)-C(204)	111.4(6)	F(203)-C(209)-C(208)	108.7(9)
C(205)-C(204)-C(210)	109.8(7)	F(207)-C(211)-F(208)	106.4(7)
C(205)-C(204)-C(203)	109.2(6)	F(207)-C(211)-C(212)	112.6(9)
C(210)-C(204)-C(203)	110.7(7)	F(208)-C(211)-C(212)	101.9(9)
C(205)-C(204)-C(211)	109.4(7)	F(207)-C(211)-C(204)	107.4(8)
C(210)-C(204)-C(211)	110.0(7)	F(208)-C(211)-C(204)	108.0(7)
C(203)-C(204)-C(211)	107.7(7)	C(212)-C(211)-C(204)	119.6(8)
C(204)-C(205)-C(206)	115.8(7)	F(209)-C(212)-C(211)	106(1)
C(201)-C(206)-C(205)	112.5(6)	F(209)-C(212)-C(213)	108(1)
F(206)-C(207)-F(205)	107.9(6)	C(211)-C(212)-C(213)	112(1)
F(206)-C(207)-C(208)	107.0(6)	F(211)-C(213)-F(212)	116(1)
F(205)-C(207)-C(208)	107.6(6)	F(211)-C(213)-F(210)	104(1)
F(206)-C(207)-C(201)	109.6(6)	F(212)-C(213)-F(210)	100(1)
F(205)-C(207)-C(201)	109.1(6)	F(211)-C(213)-C(212)	114(1)
C(208)-C(207)-C(201)	115.4(7)	F(212)-C(213)-C(212)	114(1)
F(204)-C(208)-C(209)	103.0(7)	F(210)-C(213)-C(212)	107(1)

The Crystallographically Dissimilar Structures for (69).

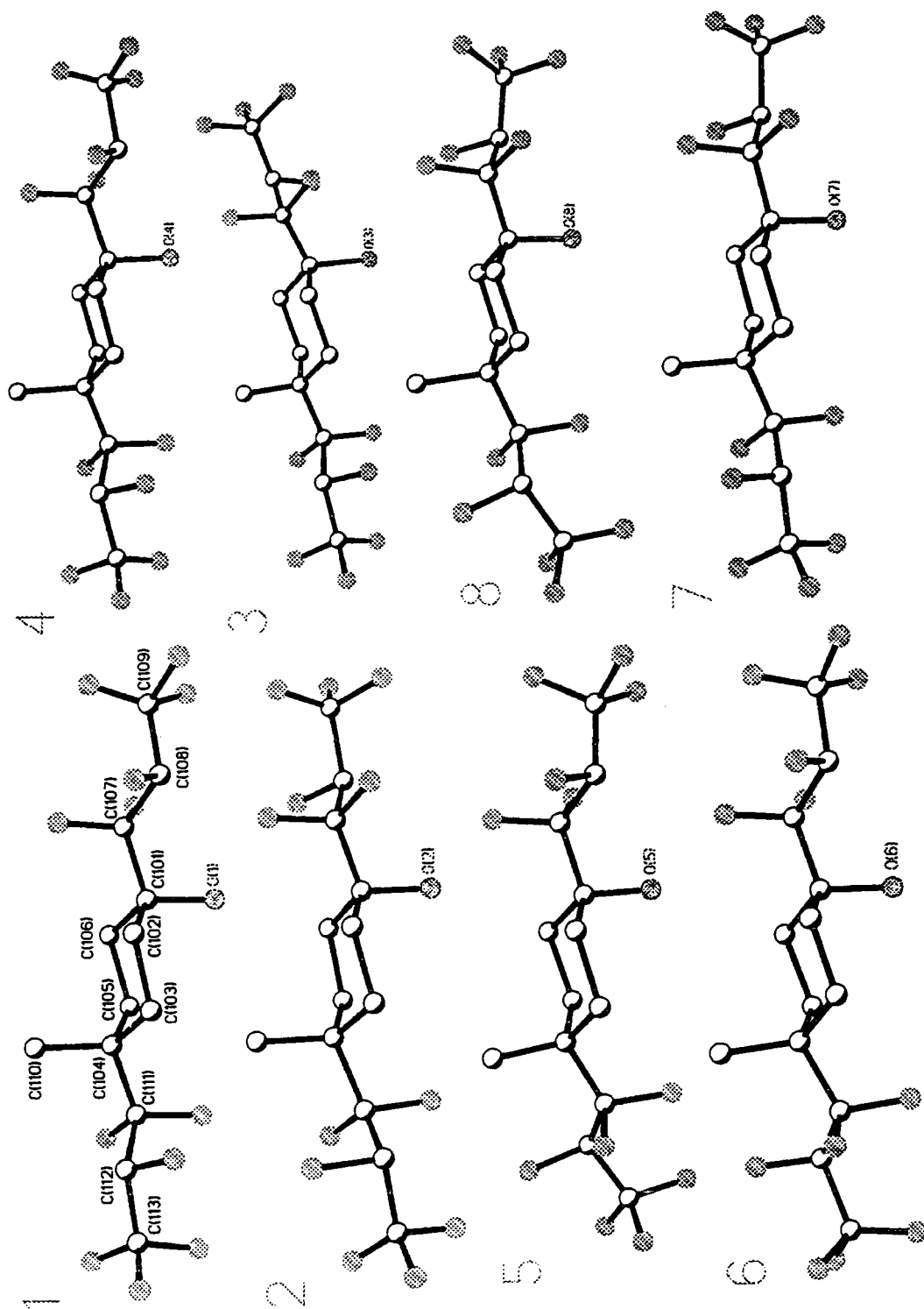

X-Ray Crystal Structure 2: 1-(1,1,2,3,3,3-Hexafluoropropyl)-4-*tert*-butylcyclohexanol (**71a**).

Identification code	105
Empirical formula	C12 H20 F6 O
Formula weight	294.28
Temperature	100(2) K
Wavelength	0.71073 Å
Crystal system	Monoclinic
Space group	P 21/n
Unit cell dimensions	a = 15.1257(3) Å alpha = 90 deg. b = 17.1114(3) Å beta = 105.64 deg. c = 17.6818(2) Å gamma = 90 deg.
Volume	4406.95(13) Å ³
Z	12
Density (calculated)	1.331 Mg/m ³
Absorption coefficient	0.134 mm ⁻¹
F(000)	1848
Crystal size	0.4 x 0.2 x 0.04 mm
Theta range for data collection	1.58 to 22.50 deg.
Index ranges	-19<=h<=17, -22<=k<=22, -22<=l<=22
Reflections collected	25569
Independent reflections	5770 [R(int) = 0.2132]
Refinement method	Full-matrix least-squares on F ²
Data / restraints / parameters	5073 / 0 / 505
Goodness-of-fit on F ²	1.131
Final R indices [I >= 2sigma(I)]	R1 = 0.1206, wR2 = 0.2602
R indices (all data)	R1 = 0.2228, wR2 = 0.3612
Largest diff. peak and hole	0.618 and -0.458 e.Å ⁻³

Table 3. Bond lengths [Å] and angles [deg] for 1.

O(1)-C(101)	1.429(10)
F(101)-C(107)	1.385(11)
F(102)-C(107)	1.347(11)
F(103)-C(108)	1.403(11)
F(104)-C(109)	1.369(13)
F(105)-C(109)	1.322(12)
F(106)-C(109)	1.279(13)
C(101)-C(102)	1.525(13)
C(101)-C(106)	1.533(13)
C(101)-C(107)	1.563(13)
C(102)-C(103)	1.519(13)
C(103)-C(104)	1.522(13)
C(104)-C(105)	1.508(12)
C(104)-C(110)	1.556(13)
C(105)-C(106)	1.530(13)
C(107)-C(108)	1.525(14)
C(108)-C(109)	1.49(2)
C(110)-C(111)	1.508(13)
C(110)-C(113)	1.511(14)
C(110)-C(112)	1.546(13)
O(2)-C(201)	1.434(10)
F(201)-C(207)	1.389(10)
F(202)-C(207)	1.368(10)
F(203)-C(208)	1.379(11)
F(204)-C(209)	1.321(13)
F(205)-C(209)	1.346(11)
F(206)-C(209)	1.308(13)
C(201)-C(202)	1.526(12)
C(201)-C(206)	1.532(12)
C(201)-C(207)	1.543(13)
C(202)-C(203)	1.531(13)
C(203)-C(204)	1.544(13)
C(204)-C(205)	1.517(12)
C(204)-C(210)	1.553(13)
C(205)-C(206)	1.522(12)
C(207)-C(208)	1.539(13)
C(208)-C(209)	1.52(2)
C(210)-C(212)	1.517(13)
C(210)-C(213)	1.525(13)
C(210)-C(211)	1.537(13)

O(1)-C(101)-C(102)	107.4(7)
O(1)-C(101)-C(106)	110.3(7)
C(102)-C(101)-C(106)	110.6(8)
O(1)-C(101)-C(107)	105.9(7)
C(102)-C(101)-C(107)	112.4(8)
C(106)-C(101)-C(107)	110.1(7)
C(103)-C(102)-C(101)	112.1(8)
C(104)-C(103)-C(102)	114.0(8)
C(105)-C(104)-C(103)	107.7(7)
C(105)-C(104)-C(110)	115.4(7)
C(103)-C(104)-C(110)	115.5(7)
C(106)-C(105)-C(104)	112.7(8)
C(106)-C(105)-C(101)	112.3(8)
F(101)-C(107)-F(102)	106.6(8)
F(102)-C(107)-C(108)	110.1(8)
F(103)-C(108)-C(107)	107.5(8)
F(104)-C(109)-F(105)	109.6(8)
F(104)-C(109)-C(101)	107.1(8)
C(108)-C(109)-C(101)	115.5(8)
F(103)-C(108)-C(109)	104.8(8)
F(203)-C(208)-C(207)	106.3(8)
C(207)-C(208)-C(201)	115.0(10)
F(204)-C(209)-F(205)	110.9(9)

F(106)-C(109)-F(104)	105.4(11)
F(105)-C(109)-F(104)	103.1(9)
F(106)-C(109)-C(108)	117.3(10)
F(105)-C(109)-C(108)	110.0(10)
F(109)-C(109)-C(108)	109.0(9)
C(111)-C(110)-C(113)	110.0(8)
C(111)-C(110)-C(112)	107.8(8)
C(113)-C(110)-C(112)	107.1(9)
C(111)-C(110)-C(104)	111.3(8)
C(113)-C(110)-C(104)	110.6(7)
C(112)-C(110)-C(104)	109.9(8)
O(2)-C(201)-C(202)	108.0(7)
O(2)-C(201)-C(206)	109.9(7)
C(202)-C(201)-C(206)	109.7(7)
O(2)-C(201)-C(207)	105.8(7)
C(202)-C(201)-C(207)	111.7(7)
C(206)-C(201)-C(207)	111.7(7)
C(201)-C(202)-C(203)	112.0(7)
C(202)-C(203)-C(204)	111.3(8)
C(205)-C(204)-C(203)	107.8(7)
C(205)-C(204)-C(210)	114.1(8)
C(203)-C(204)-C(210)	112.1(8)
C(204)-C(205)-C(206)	112.6(8)
C(205)-C(206)-C(201)	112.3(7)
F(202)-C(207)-F(201)	105.1(7)
F(202)-C(207)-C(208)	110.0(8)
F(201)-C(207)-C(208)	107.1(7)
F(202)-C(207)-C(201)	110.4(7)
F(201)-C(207)-C(201)	108.1(7)
C(208)-C(207)-C(201)	115.6(8)
F(203)-C(208)-C(209)	105.8(8)
F(203)-C(208)-C(207)	107.1(8)
C(209)-C(208)-C(207)	114.6(8)
F(206)-C(209)-F(204)	109.3(9)
F(206)-C(209)-F(205)	108.0(10)
F(206)-C(209)-F(205)	106.0(9)
F(206)-C(209)-C(208)	114.0(10)
F(206)-C(209)-C(208)	110.4(10)
F(206)-C(209)-C(208)	108.8(8)
C(212)-C(210)-C(213)	108.1(8)
C(212)-C(210)-C(211)	107.1(8)
C(213)-C(210)-C(211)	108.0(8)
C(212)-C(210)-C(204)	113.9(8)
C(213)-C(210)-C(204)	110.9(8)
C(211)-C(210)-C(204)	108.7(8)

The Crystallographically Dissimilar Structures for (71a).

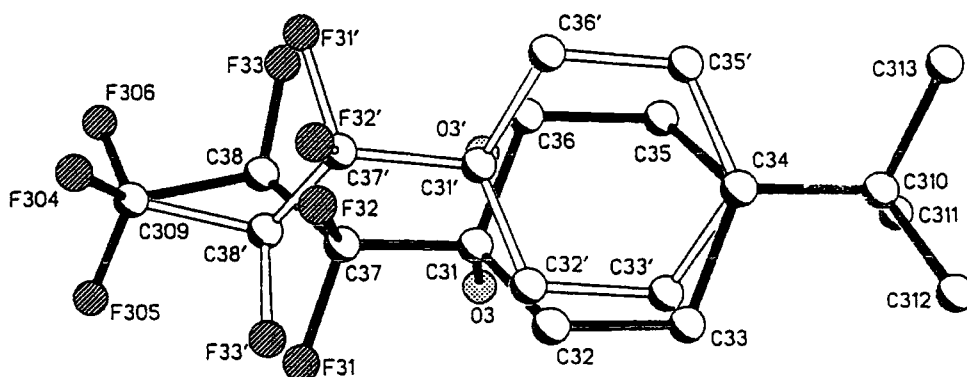
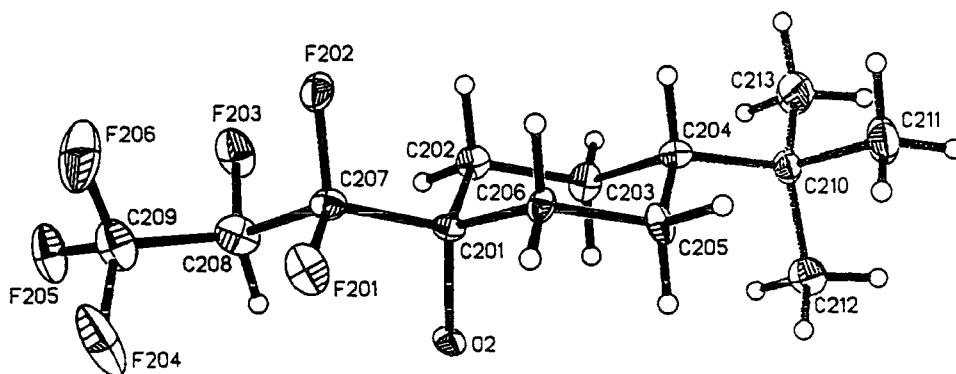
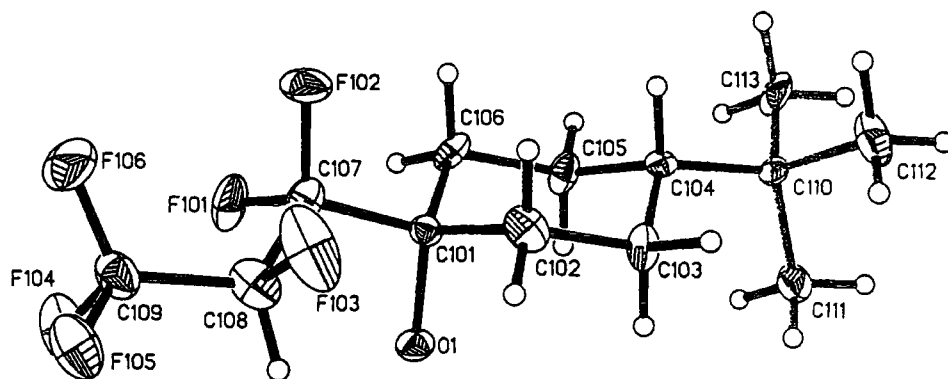

X-Ray Crystal Structure 3: 1,3-Di-(1,1,2,3,3,3-hexafluoropropyl)-cyclohexane-1,3-diol (**88**).

Identification code	97srv063
Empirical formula	C12 H12 F12 O2
Formula weight	416.22
Temperature	150(2) K
Wavelength	0.71073 A
Crystal system	Monoclinic
Space group	P2(1)/n
Unit cell dimensions	a = 10.5904(7) A alpha = 90 deg. b = 39.3474(5) A beta = 94.602(5) deg. c = 15.1346(10) A gamma = 90 deg.
Volume	6286.3(6) A ³
Z	16
Density (calculated)	1.759 g/cm ³
Absorption coefficient	0.211 mm ⁻¹
F(000)	3328
Crystal size	0.45 x 0.25 x 0.06 mm
Theta range for data collection	1.45 to 25.00 deg.
Index ranges	-10<=h<=13, -49<=k<=51, -19<=l<=18
Reflections collected	37884
Independent reflections	11064 [R(int) = 0.1290]
Observed reflections, I>2sigma(I)	6678
Absorption correction	Semi-empirical from multiscans
Max. and min. transmission	1.0000 and 0.6017
Refinement method	Full-matrix least-squares on F ²
Data / restraints / parameters	10676 / 0 / 858
Goodness-of-fit on F ²	1.163
Final R indices [I>2sigma(I)]	R1 = 0.1416, wR2 = 0.3058
R indices (all data)	R1 = 0.2140, wR2 = 0.3792
Largest shift/e.s.d. ratio	-0.302
Largest diff. peak and hole	0.855 and -0.457 e.A ⁻³

Table 2. Atomic coordinates ($\times 10^4$) and equivalent isotropic displacement parameters ($\text{\AA}^2 \times 10^3$) for 1. $U(\text{eq})$ is defined as one third of the trace of the orthogonalized U_{ij} tensor.

	x	y	z	$U(\text{eq})$
C(1A)	4581(9)	712(2)	3602(6)	37(2)
C(2A)	4005(8)	1024(2)	4009(6)	31(2)
C(3A)	4807(8)	1141(2)	4849(6)	28(2)
C(4A)	5015(10)	855(3)	5518(7)	47(3)
C(5A)	5571(10)	545(3)	5124(7)	49(3)
C(6A)	4775(10)	417(3)	4286(7)	46(3)
C(7A)	3736(9)	583(3)	2777(6)	41(2)
C(8A)	3577(10)	847(3)	2051(6)	47(3)
C(9A)	3214(13)	672(4)	1106(7)	63(3)
C(10A)	4246(8)	1461(2)	5282(6)	34(2)
C(11A)	4057(9)	1779(3)	4679(6)	38(2)
C(12A)	3787(12)	2104(3)	5129(8)	63(3)
O(1A)	5771(6)	795(2)	3250(4)	39(2)
O(3A)	5992(5)	1257(2)	4537(4)	32(1)
F(1A)	2589(6)	488(2)	3021(4)	60(2)
F(2A)	4306(6)	296(2)	2455(4)	61(2)
F(3A)	2605(7)	1051(2)	2198(4)	71(2)
F(4A)	2860(7)	922(2)	536(4)	81(2)
F(5A)	2272(7)	454(2)	1109(4)	71(2)
F(6A)	4197(7)	525(2)	803(4)	93(3)
F(7A)	3122(5)	1377(2)	5617(3)	47(1)
F(8A)	5074(5)	1549(1)	5992(3)	44(1)
F(9A)	2983(7)	1725(2)	4098(5)	56(3)
F(9A')	5242(30)	1901(8)	4640(21)	53(11)
F(10A)	3510(6)	2349(2)	4579(4)	63(2)
F(11A)	2949(12)	2093(2)	5693(6)	134(5)
F(12A)	4900(9)	2208(2)	5591(6)	102(3)
C(1B)	9077(8)	1439(2)	5534(6)	29(2)
C(2B)	9971(8)	1553(2)	6321(6)	31(2)
C(3B)	9447(9)	1856(2)	6815(6)	35(2)
C(4B)	9121(9)	2152(2)	6164(6)	37(2)
C(5B)	8211(9)	2036(3)	5396(7)	43(2)
C(6B)	8753(9)	1743(2)	4900(6)	40(2)
C(7B)	9647(9)	1143(3)	5020(6)	39(2)
C(8B)	9970(10)	824(3)	5572(6)	44(2)
C(9B)	10132(18)	511(4)	5059(11)	49(4)
C(9B')	10859(36)	537(8)	5234(22)	28(8)
C(10B)	10368(8)	1964(2)	7592(6)	37(2)
C(11B)	10690(10)	1693(3)	8283(6)	44(2)
C(12B)	11089(10)	1835(3)	9211(7)	52(3)
O(1B)	7938(5)	1291(2)	5841(4)	32(1)
O(3B)	8322(5)	1729(2)	7196(4)	34(1)
F(1B)	10684(5)	1252(2)	4636(4)	52(2)
F(2B)	8776(5)	1053(2)	4339(3)	48(2)
F(3B)	11188(8)	899(2)	6011(5)	58(3)
F(3B')	8659(27)	610(8)	5491(20)	85(10)
F(4B)	10678(8)	267(2)	5608(5)	79(2)
F(5B)	10801(8)	528(2)	4373(5)	92(3)
F(6B)	9005(10)	402(2)	4750(7)	76(3)
F(6B')	11948(26)	661(7)	5419(18)	78(9)
F(7B)	11459(5)	2089(2)	7286(3)	47(1)
F(8B)	9829(5)	2242(1)	8000(4)	48(1)
F(9B)	11730(6)	1512(2)	8036(4)	59(2)
F(10B)	11557(6)	1582(2)	9725(4)	69(2)
F(11B)	11957(7)	2074(2)	9230(4)	69(2)
F(12B)	10045(7)	1948(2)	9583(4)	89(3)
C(1C)	5801(8)	2137(2)	-1420(5)	27(2)
C(2C)	5549(8)	2093(2)	-444(6)	30(2)

C(3C)	5733(8)	1729(2)	-127(5)	27(2)
C(4C)	4947(9)	1476(2)	-713(6)	38(2)
C(5C)	5221(9)	1528(2)	-1709(6)	40(2)
C(6C)	4996(9)	1891(2)	-1998(6)	39(2)
C(7C)	5490(10)	2510(3)	-1667(6)	42(2)
C(8C)	6247(17)	2660(3)	-2423(9)	79(4)
C(9C)	5776(20)	3005(4)	-2783(10)	100(6)
C(10C)	5405(9)	1694(2)	851(6)	37(2)
C(11C)	6225(11)	1896(2)	1532(6)	37(2)
C(12C)	6111(13)	1799(3)	2505(6)	59(3)
O(1C)	7099(6)	2094(2)	-1533(4)	38(2)
O(3C)	7067(6)	1656(2)	-111(4)	37(2)
F(1C)	5872(7)	2726(2)	-986(4)	60(2)
F(2C)	4242(6)	2559(2)	-1821(5)	68(2)
F(3C)	6334(8)	2444(2)	-3074(4)	63(3)
F(3C')	7391(41)	2709(10)	-2351(26)	70(14)
F(4C)	5511(14)	3218(2)	-2208(6)	146(5)
F(5C)	4675(12)	2964(3)	-3293(7)	136(4)
F(6C)	6561(13)	3115(3)	-3341(7)	144(4)
F(7C)	4165(6)	1781(2)	912(4)	59(2)
F(8C)	5497(6)	1359(1)	1102(4)	54(2)
F(9C)	5944(10)	2226(2)	1478(4)	87(4)
F(9C')	7223(65)	1904(16)	1501(41)	79(23)
F(10C)	6667(8)	2022(2)	3049(4)	75(2)
F(11C)	4974(8)	1741(3)	2698(4)	116(4)
F(12C)	6758(9)	1501(2)	2673(4)	94(3)
C(1D)	8554(9)	782(2)	397(6)	39(2)
C(2D)	8388(9)	425(2)	756(6)	37(2)
C(3D)	8056(8)	430(2)	1740(6)	34(2)
C(4D)	9056(9)	629(2)	2309(7)	43(2)
C(5D)	9220(11)	985(3)	1947(8)	57(3)
C(6D)	9548(11)	987(3)	975(7)	57(3)
C(7D)	8958(10)	766(3)	-574(7)	49(3)
C(8D)	8026(14)	574(3)	-1218(7)	64(3)
C(9D)	8084(17)	655(4)	-2193(9)	84(5)
C(10D)	7923(10)	71(3)	2095(6)	45(3)
C(11D)	6901(15)	-146(3)	1606(7)	69(4)
C(12D)	6513(21)	-468(4)	2066(11)	103(6)
O(1D)	7368(6)	958(2)	308(4)	44(2)
O(3D)	6831(6)	590(2)	1722(4)	37(2)
F(1D)	10118(7)	639(2)	-586(5)	89(3)
F(2D)	8985(8)	1095(2)	-875(5)	80(2)
F(3D)	8418(12)	229(2)	-1130(5)	91(5)
F(3D')	6819(40)	558(10)	-1079(27)	104(15)
F(4D)	7538(12)	421(2)	-2708(5)	127(4)
F(5D)	9273(9)	694(2)	-2417(5)	106(3)
F(6D)	7481(10)	943(2)	-2370(5)	108(3)
F(7D)	9035(7)	-92(2)	2150(4)	71(2)
F(8D)	7541(7)	94(2)	2947(3)	62(2)
F(9D)	7314(10)	-259(2)	837(4)	75(4)
F(9D')	6114(35)	-60(9)	1159(26)	79(13)
F(10D)	5739(14)	-664(3)	1525(7)	158(6)
F(11D)	7443(13)	-656(2)	2379(7)	130(4)
F(12D)	5829(12)	-388(2)	2759(6)	125(4)

Table 3. Bond lengths [Å] and angles [deg] for 1.

C(1A)-O(1A)	1.444(11)	C(1A)-C(2A)	1.522(12)
C(1A)-C(7A)	1.561(13)	C(1A)-C(6A)	1.559(14)
C(2A)-C(3A)	1.542(12)	C(3A)-O(3A)	1.450(10)
C(3A)-C(4A)	1.518(13)	C(3A)-C(10A)	1.559(12)
C(4A)-C(5A)	1.501(14)	C(5A)-C(6A)	1.549(14)
C(7A)-F(1A)	1.350(11)	C(7A)-F(2A)	1.387(11)
C(7A)-C(8A)	1.512(14)	C(8A)-F(3A)	1.337(12)
C(8A)-C(9A)	1.607(14)	C(9A)-F(6A)	1.305(14)
C(9A)-F(5A)	1.315(14)	C(9A)-F(4A)	1.342(14)
C(10A)-F(7A)	1.372(10)	C(10A)-F(8A)	1.375(10)
C(10A)-C(11A)	1.551(13)	C(11A)-F(9A')	1.35(3)
C(11A)-F(9A)	1.397(11)	C(11A)-C(12A)	1.49(2)
C(12A)-F(11A)	1.28(2)	C(12A)-F(10A)	1.293(13)
C(12A)-F(12A)	1.383(14)	C(1B)-O(1B)	1.449(10)
C(1B)-C(2B)	1.528(12)	C(1B)-C(7B)	1.548(13)
C(1B)-C(6B)	1.557(12)	C(2B)-C(3B)	1.536(12)
C(3B)-O(3B)	1.454(10)	C(3B)-C(10B)	1.526(12)
C(3B)-C(4B)	1.547(13)	C(4B)-C(5B)	1.519(13)
C(5B)-C(6B)	1.512(13)	C(7B)-F(1B)	1.352(11)
C(7B)-F(2B)	1.373(10)	C(7B)-C(8B)	1.531(14)
C(8B)-F(3B)	1.433(13)	C(8B)-C(9B)	1.48(2)
C(8B)-C(9B')	1.58(3)	C(8B)-F(3B')	1.62(3)
C(9B)-F(5B)	1.31(2)	C(9B)-F(6B)	1.32(2)
C(9B)-F(4B)	1.37(2)	C(9B')-F(4B)	1.23(3)
C(9B')-F(6B')	1.26(4)	C(9B')-F(5B)	1.30(3)
C(10B)-F(7B)	1.371(10)	C(10B)-F(8B)	1.401(10)
C(10B)-C(11B)	1.514(14)	C(11B)-F(9B)	1.388(11)
C(11B)-C(12B)	1.539(13)	C(12B)-F(11B)	1.313(13)
C(12B)-F(10B)	1.336(13)	C(12B)-F(12B)	1.355(12)
C(1C)-O(1C)	1.409(10)	C(1C)-C(6C)	1.520(12)
C(1C)-C(2C)	1.532(12)	C(1C)-C(7C)	1.545(13)
C(2C)-C(3C)	1.520(12)	C(3C)-O(3C)	1.440(10)
C(3C)-C(4C)	1.533(12)	C(3C)-C(10C)	1.552(11)
C(4C)-C(5C)	1.571(13)	C(5C)-C(6C)	1.508(13)
C(7C)-F(2C)	1.337(11)	C(7C)-F(1C)	1.370(11)
C(7C)-C(8C)	1.56(2)	C(8C)-F(3C')	1.22(4)
C(8C)-F(3C)	1.31(2)	C(8C)-C(9C)	1.53(2)
C(9C)-F(4C)	1.26(2)	C(9C)-F(6C)	1.31(2)
C(9C)-F(5C)	1.36(2)	C(10C)-F(7C)	1.367(10)
C(10C)-F(8C)	1.374(11)	C(10C)-C(11C)	1.519(14)
C(11C)-F(9C')	1.06(7)	C(11C)-F(9C)	1.333(12)
C(11C)-C(12C)	1.535(12)	C(12C)-F(11C)	1.282(14)
C(12C)-F(10C)	1.311(13)	C(12C)-F(12C)	1.372(14)
C(1D)-O(1D)	1.430(11)	C(1D)-C(2D)	1.524(13)
C(1D)-C(6D)	1.541(14)	C(1D)-C(7D)	1.564(14)
C(2D)-C(3D)	1.558(13)	C(3D)-O(3D)	1.440(11)
C(3D)-C(10D)	1.523(14)	C(3D)-C(4D)	1.527(13)
C(4D)-C(5D)	1.52(2)	C(5D)-C(6D)	1.54(2)
C(7D)-F(1D)	1.328(12)	C(7D)-F(2D)	1.373(12)
C(7D)-C(8D)	1.53(2)	C(8D)-F(3D')	1.31(4)
C(8D)-F(3D)	1.42(2)	C(8D)-C(9D)	1.52(2)
C(9D)-F(4D)	1.31(2)	C(9D)-F(6D)	1.32(2)
C(9D)-F(5D)	1.34(2)	C(10D)-F(7D)	1.339(12)
C(10D)-F(8D)	1.385(10)	C(10D)-C(11D)	1.52(2)
C(11D)-F(9D')	1.08(4)	C(11D)-F(9D)	1.353(14)
C(11D)-C(12D)	1.52(2)	C(12D)-F(11D)	1.29(2)
C(12D)-F(10D)	1.35(2)	C(12D)-F(12D)	1.36(2)
O(1A)-C(1A)-C(2A)	110.9(7)	O(1A)-C(1A)-C(7A)	103.9(7)
C(2A)-C(1A)-C(7A)	111.3(8)	O(1A)-C(1A)-C(6A)	109.9(8)
C(2A)-C(1A)-C(6A)	111.5(8)	C(7A)-C(1A)-C(6A)	109.0(8)
C(1A)-C(2A)-C(3A)	111.3(7)	O(3A)-C(3A)-C(4A)	111.5(7)
O(3A)-C(3A)-C(2A)	105.1(6)	C(4A)-C(3A)-C(2A)	111.6(7)
O(3A)-C(3A)-C(10A)	104.7(7)	C(4A)-C(3A)-C(10A)	111.0(7)

C(2A)-C(3A)-C(10A)	112.7(7)	C(5A)-C(4A)-C(3A)	112.3(9)
C(4A)-C(5A)-C(6A)	112.6(9)	C(5A)-C(6A)-C(1A)	109.6(8)
F(1A)-C(7A)-F(2A)	107.2(8)	F(1A)-C(7A)-C(8A)	109.9(8)
F(2A)-C(7A)-C(8A)	109.2(8)	F(1A)-C(7A)-C(1A)	110.0(7)
F(2A)-C(7A)-C(1A)	107.9(8)	C(8A)-C(7A)-C(1A)	112.4(8)
F(3A)-C(8A)-C(7A)	109.4(8)	F(3A)-C(8A)-C(9A)	105.9(8)
C(7A)-C(8A)-C(9A)	110.9(9)	F(6A)-C(9A)-F(5A)	109.9(11)
F(6A)-C(9A)-F(4A)	106.7(11)	F(5A)-C(9A)-F(4A)	107.9(10)
F(6A)-C(9A)-C(8A)	111.2(9)	F(5A)-C(9A)-C(8A)	113.8(10)
F(4A)-C(9A)-C(8A)	107.0(10)	F(7A)-C(10A)-F(8A)	106.9(7)
F(7A)-C(10A)-C(11A)	109.8(7)	F(8A)-C(10A)-C(11A)	107.5(7)
F(7A)-C(10A)-C(3A)	109.2(7)	F(8A)-C(10A)-C(3A)	107.0(7)
C(11A)-C(10A)-C(3A)	116.0(7)	F(9A')-C(11A)-C(12A)	86(2)
F(9A)-C(11A)-C(12A)	104.1(8)	F(9A')-C(11A)-C(10A)	104(2)
F(9A)-C(11A)-C(10A)	107.9(8)	C(12A)-C(11A)-C(10A)	116.4(8)
F(11A)-C(12A)-F(10A)	108.7(11)	F(11A)-C(12A)-F(12A)	106.3(11)
F(10A)-C(12A)-F(12A)	104.2(11)	F(11A)-C(12A)-C(11A)	116.5(12)
F(10A)-C(12A)-C(11A)	112.9(9)	F(12A)-C(12A)-C(11A)	107.4(10)
O(1B)-C(1B)-C(2B)	110.3(7)	O(1B)-C(1B)-C(7B)	103.3(7)
C(2B)-C(1B)-C(7B)	111.8(7)	O(1B)-C(1B)-C(6B)	110.9(7)
C(2B)-C(1B)-C(6B)	110.3(7)	C(7B)-C(1B)-C(6B)	110.1(7)
C(1B)-C(2B)-C(3B)	112.5(7)	O(3B)-C(3B)-C(10B)	106.5(7)
O(3B)-C(3B)-C(2B)	105.4(7)	C(10B)-C(3B)-C(2B)	111.0(7)
O(3B)-C(3B)-C(4B)	111.3(7)	C(10B)-C(3B)-C(4B)	112.2(8)
C(2B)-C(3B)-C(4B)	110.2(7)	C(5B)-C(4B)-C(3B)	111.0(8)
C(6B)-C(5B)-C(4B)	111.4(8)	C(5B)-C(6B)-C(1B)	110.8(8)
F(1B)-C(7B)-F(2B)	106.2(7)	F(1B)-C(7B)-C(8B)	109.9(8)
F(2B)-C(7B)-C(8B)	107.7(8)	F(1B)-C(7B)-C(1B)	110.0(8)
F(2B)-C(7B)-C(1B)	107.8(7)	C(8B)-C(7B)-C(1B)	114.8(8)
F(3B)-C(8B)-C(9B)	106.1(11)	F(3B)-C(8B)-C(7B)	103.8(8)
C(9B)-C(8B)-C(7B)	115.4(9)	C(7B)-C(8B)-C(9B')	121.5(14)
C(7B)-C(8B)-F(3B')	103.5(12)	C(9B')-C(8B)-F(3B')	98(2)
F(5B)-C(9B)-F(6B)	105.5(13)	F(5B)-C(9B)-F(4B)	106.9(13)
F(6B)-C(9B)-F(4B)	108.3(13)	F(5B)-C(9B)-C(8B)	117.9(13)
F(6B)-C(9B)-C(8B)	108.6(13)	F(4B)-C(9B)-C(8B)	109.2(12)
F(4B)-C(9B')-F(6B')	114(3)	F(4B)-C(9B')-F(5B)	116(3)
F(6B')-C(9B')-F(5B)	102(3)	F(4B)-C(9B')-C(8B)	111(2)
F(6B')-C(9B')-C(8B)	102(3)	F(5B)-C(9B')-C(8B)	111(2)
F(7B)-C(10B)-F(8B)	104.7(7)	F(7B)-C(10B)-C(11B)	109.7(8)
F(8B)-C(10B)-C(11B)	108.9(7)	F(7B)-C(10B)-C(3B)	110.0(7)
F(8B)-C(10B)-C(3B)	107.4(7)	C(11B)-C(10B)-C(3B)	115.5(8)
F(9B)-C(11B)-C(10B)	108.4(7)	F(9B)-C(11B)-C(12B)	105.5(8)
C(10B)-C(11B)-C(12B)	113.7(9)	F(11B)-C(12B)-F(10B)	107.1(8)
F(11B)-C(12B)-F(12B)	110.5(10)	F(10B)-C(12B)-F(12B)	106.2(9)
F(11B)-C(12B)-C(11B)	114.9(9)	F(10B)-C(12B)-C(11B)	108.7(9)
F(12B)-C(12B)-C(11B)	109.0(8)	O(1C)-C(1C)-C(6C)	111.2(7)
O(1C)-C(1C)-C(2C)	110.5(7)	C(6C)-C(1C)-C(2C)	110.5(7)
O(1C)-C(1C)-C(7C)	106.0(7)	C(6C)-C(1C)-C(7C)	111.5(7)
C(2C)-C(1C)-C(7C)	106.9(7)	C(3C)-C(2C)-C(1C)	112.6(7)
O(3C)-C(3C)-C(2C)	107.1(7)	O(3C)-C(3C)-C(4C)	111.5(7)
C(2C)-C(3C)-C(4C)	112.3(7)	O(3C)-C(3C)-C(10C)	105.2(6)
C(2C)-C(3C)-C(10C)	110.5(7)	C(4C)-C(3C)-C(10C)	110.0(7)
C(3C)-C(4C)-C(5C)	109.7(7)	C(6C)-C(5C)-C(4C)	111.4(8)
C(5C)-C(6C)-C(1C)	111.5(8)	F(2C)-C(7C)-F(1C)	105.7(8)
F(2C)-C(7C)-C(1C)	111.5(8)	F(1C)-C(7C)-C(1C)	111.2(7)
F(2C)-C(7C)-C(8C)	112.1(9)	F(1C)-C(7C)-C(8C)	100.3(9)
C(1C)-C(7C)-C(8C)	115.1(9)	F(3C')-C(8C)-C(9C)	101(2)
F(3C)-C(8C)-C(9C)	110.4(11)	F(3C')-C(8C)-C(7C)	124(2)
F(3C)-C(8C)-C(7C)	112.1(11)	C(9C)-C(8C)-C(7C)	115.1(12)
F(4C)-C(9C)-F(6C)	115(2)	F(4C)-C(9C)-F(5C)	104(2)
F(6C)-C(9C)-F(5C)	103.5(13)	F(4C)-C(9C)-C(8C)	115.4(11)
F(6C)-C(9C)-C(8C)	108.5(13)	F(5C)-C(9C)-C(8C)	110(2)
F(7C)-C(10C)-F(8C)	105.6(8)	F(7C)-C(10C)-C(11C)	108.9(8)
F(8C)-C(10C)-C(11C)	106.8(7)	F(7C)-C(10C)-C(3C)	109.4(7)
F(8C)-C(10C)-C(3C)	109.3(7)	C(11C)-C(10C)-C(3C)	116.2(8)
F(9C')-C(11C)-C(10C)	120(4)	F(9C)-C(11C)-C(10C)	110.8(8)
F(9C')-C(11C)-C(12C)	102(4)	F(9C)-C(11C)-C(12C)	105.5(8)
C(10C)-C(11C)-C(12C)	115.9(9)	F(11C)-C(12C)-F(10C)	111.0(9)

F(11C)-C(12C)-F(12C)	105.6(11)	F(10C)-C(12C)-F(12C)	105.3(10)
F(11C)-C(12C)-C(11C)	114.2(10)	F(10C)-C(12C)-C(11C)	111.7(10)
F(12C)-C(12C)-C(11C)	108.3(9)	O(1D)-C(1D)-C(2D)	110.7(8)
O(1D)-C(1D)-C(6D)	110.8(8)	C(2D)-C(1D)-C(6D)	112.0(8)
O(1D)-C(1D)-C(7D)	103.6(7)	C(2D)-C(1D)-C(7D)	110.2(8)
C(6D)-C(1D)-C(7D)	109.2(8)	C(1D)-C(2D)-C(3D)	111.7(8)
O(3D)-C(3D)-C(10D)	107.7(7)	O(3D)-C(3D)-C(4D)	111.7(7)
C(10D)-C(3D)-C(4D)	110.9(8)	O(3D)-C(3D)-C(2D)	105.1(7)
C(10D)-C(3D)-C(2D)	111.1(7)	C(4D)-C(3D)-C(2D)	110.3(8)
C(5D)-C(4D)-C(3D)	111.3(8)	C(4D)-C(5D)-C(6D)	113.0(10)
C(5D)-C(6D)-C(1D)	110.1(9)	F(1D)-C(7D)-F(2D)	107.8(9)
F(1D)-C(7D)-C(8D)	110.8(10)	F(2D)-C(7D)-C(8D)	106.6(9)
F(1D)-C(7D)-C(1D)	110.6(9)	F(2D)-C(7D)-C(1D)	106.8(8)
C(8D)-C(7D)-C(1D)	114.0(9)	F(3D')-C(8D)-C(9D)	106(2)
F(3D)-C(8D)-C(9D)	105.0(10)	F(3D')-C(8D)-C(7D)	121(2)
F(3D)-C(8D)-C(7D)	104.1(11)	C(9D)-C(8D)-C(7D)	116.1(12)
F(4D)-C(9D)-F(6D)	107.4(14)	F(4D)-C(9D)-F(5D)	108.0(11)
F(6D)-C(9D)-F(5D)	107.6(13)	F(4D)-C(9D)-C(8D)	112.3(13)
F(6D)-C(9D)-C(8D)	108.8(11)	F(5D)-C(9D)-C(8D)	112.5(14)
F(7D)-C(10D)-F(8D)	107.2(7)	F(7D)-C(10D)-C(11D)	110.4(9)
F(8D)-C(10D)-C(11D)	103.9(9)	F(7D)-C(10D)-C(3D)	111.2(9)
F(8D)-C(10D)-C(3D)	108.0(8)	C(11D)-C(10D)-C(3D)	115.5(8)
F(9D')-C(11D)-C(12D)	109(2)	F(9D)-C(11D)-C(12D)	103.6(11)
F(9D')-C(11D)-C(10D)	128(2)	F(9D)-C(11D)-C(10D)	109.7(11)
C(12D)-C(11D)-C(10D)	116.9(12)	F(11D)-C(12D)-F(10D)	107.8(13)
F(11D)-C(12D)-F(12D)	106.7(13)	F(10D)-C(12D)-F(12D)	105(2)
F(11D)-C(12D)-C(11D)	115(2)	F(10D)-C(12D)-C(11D)	111.8(12)
F(12D)-C(12D)-C(11D)	109.9(12)		

Table 4. Anisotropic displacement parameters ($A^2 \times 10^3$) for 1.
 The anisotropic displacement factor exponent takes the form:
 $-2 \pi^2 [h^2 a^2 U_{11} + \dots + 2 h k a \cdot b \cdot U_{12}]$

	U11	U22	U33	U23	U13	U12
C(7A)	46(6)	42(6)	35(5)	-11(5)	5(4)	-7(5)
C(8A)	43(6)	73(8)	24(5)	4(5)	-5(4)	-10(6)
C(9A)	65(8)	91(10)	32(6)	-14(6)	-10(6)	5(8)
C(10A)	29(5)	54(6)	21(5)	-5(4)	3(4)	-4(4)
C(11A)	44(6)	47(6)	23(5)	-3(4)	-2(4)	1(5)
C(12A)	71(8)	72(9)	44(7)	-10(6)	-14(6)	14(7)
O(1A)	43(4)	47(4)	28(3)	-9(3)	12(3)	-4(3)
O(3A)	32(3)	48(4)	17(3)	1(3)	1(2)	-2(3)
F(1A)	54(4)	86(5)	40(3)	-19(3)	15(3)	-30(3)
F(2A)	74(4)	64(4)	46(4)	-22(3)	10(3)	0(3)
F(3A)	97(6)	74(5)	38(4)	-12(3)	-16(3)	10(4)
F(4A)	79(5)	127(7)	36(4)	-4(4)	-10(3)	-16(5)
F(5A)	72(5)	86(5)	50(4)	-25(4)	-18(3)	-14(4)
F(6A)	71(5)	181(9)	28(3)	-38(4)	-3(3)	29(5)
F(7A)	47(3)	62(4)	35(3)	-5(3)	22(3)	-8(3)
F(8A)	54(3)	59(4)	19(3)	-11(2)	5(2)	3(3)
F(9A)	69(5)	57(5)	38(4)	-6(3)	-16(4)	8(4)
F(10A)	76(5)	51(4)	62(4)	3(3)	-5(3)	10(3)
F(11A)	225(12)	85(6)	111(7)	18(5)	127(8)	61(7)
F(12A)	132(8)	69(5)	94(6)	-21(4)	-57(6)	4(5)
C(7B)	34(5)	55(6)	27(5)	-15(4)	-1(4)	-10(5)
C(8B)	62(7)	45(6)	23(5)	3(4)	-2(5)	9(5)
C(10B)	24(5)	51(6)	36(5)	-14(5)	2(4)	-7(4)
C(11B)	44(6)	67(7)	21(5)	2(5)	2(4)	-5(5)
C(12B)	40(6)	84(9)	28(6)	-8(6)	-11(5)	-4(6)
O(1B)	30(3)	42(4)	25(3)	-2(3)	-2(3)	1(3)
O(3B)	29(3)	42(4)	30(3)	-6(3)	9(3)	-6(3)
F(1B)	45(3)	75(4)	37(3)	-8(3)	19(3)	-4(3)
F(2B)	52(3)	70(4)	21(3)	-11(3)	-4(2)	3(3)
F(3B)	67(6)	59(6)	43(5)	-11(4)	-23(4)	1(4)
F(4B)	115(6)	55(4)	63(5)	-7(4)	-13(4)	15(4)
F(5B)	124(7)	101(6)	53(4)	-20(4)	28(4)	48(5)
F(6B)	88(8)	55(6)	83(7)	-9(5)	-15(6)	-8(5)
F(7B)	43(3)	65(4)	34(3)	-4(3)	3(2)	-17(3)
F(8B)	53(4)	55(4)	37(3)	-11(3)	6(3)	-1(3)
F(9B)	82(5)	62(4)	33(3)	-3(3)	4(3)	16(4)
F(10B)	69(4)	106(6)	29(3)	10(3)	-8(3)	4(4)
F(11B)	80(5)	90(5)	35(3)	-22(3)	-11(3)	-21(4)
F(12B)	76(5)	151(8)	43(4)	-3(4)	20(4)	26(5)
C(7C)	47(6)	51(6)	28(5)	-1(4)	-1(4)	2(5)
C(8C)	130(14)	66(9)	47(8)	15(6)	37(8)	14(9)
C(9C)	167(18)	91(12)	50(9)	49(9)	49(11)	63(12)
C(10C)	38(5)	47(6)	25(5)	2(4)	10(4)	6(5)
C(11C)	55(7)	40(6)	18(5)	6(4)	5(4)	7(5)
C(12C)	85(9)	82(9)	12(5)	0(5)	13(5)	7(7)
O(1C)	35(3)	52(4)	27(3)	-2(3)	9(3)	12(3)
O(3C)	47(4)	41(4)	23(3)	-2(3)	11(3)	5(3)
F(1C)	95(5)	51(4)	32(3)	-11(3)	-10(3)	5(3)
F(2C)	50(4)	66(4)	87(5)	18(4)	-10(3)	8(3)
F(3C)	85(6)	80(6)	26(4)	-7(4)	19(4)	8(5)
F(4C)	294(16)	74(6)	78(6)	28(5)	59(8)	62(8)
F(5C)	157(10)	151(10)	94(7)	28(7)	-21(7)	69(8)
F(6C)	205(13)	124(8)	111(8)	51(7)	60(8)	-2(8)
F(7C)	48(4)	103(5)	28(3)	3(3)	12(3)	14(3)
F(8C)	86(5)	49(4)	31(3)	4(3)	24(3)	-6(3)
F(9C)	192(10)	43(5)	21(4)	-3(3)	-23(5)	22(5)
F(10C)	122(6)	81(5)	21(3)	-4(3)	-2(3)	5(4)
F(11C)	94(6)	234(12)	22(3)	2(5)	27(4)	-25(7)

F(12C)	168(8)	79(5)	33(4)	15(4)	1(4)	24(5)
C(7D)	56(7)	41(6)	52(7)	20(5)	27(5)	14(5)
C(8D)	107(11)	57(8)	31(6)	7(5)	18(6)	-3(7)
C(9D)	119(13)	86(11)	54(9)	14(8)	43(9)	38(10)
C(10D)	63(7)	54(6)	16(5)	-3(4)	1(4)	16(6)
C(11D)	115(12)	61(8)	29(6)	14(6)	2(7)	-11(8)
C(12D)	193(20)	54(9)	61(10)	15(8)	7(11)	21(11)
O(1D)	51(4)	46(4)	38(4)	10(3)	13(3)	8(3)
O(3D)	43(4)	49(4)	20(3)	-1(3)	8(3)	9(3)
F(1D)	76(5)	133(7)	65(5)	25(5)	44(4)	38(5)
F(2D)	111(6)	71(5)	62(4)	19(4)	39(4)	-24(4)
F(3D)	194(13)	53(6)	28(5)	8(4)	25(6)	15(6)
F(4D)	252(13)	108(7)	23(4)	-5(4)	19(5)	-2(8)
F(5D)	143(8)	139(8)	43(4)	34(5)	50(5)	61(6)
F(6D)	167(9)	106(7)	54(5)	33(4)	33(5)	54(6)
F(7D)	101(6)	69(4)	43(4)	11(3)	5(3)	43(4)
F(8D)	110(5)	69(4)	9(3)	7(3)	13(3)	14(4)
F(9D)	160(10)	51(5)	15(4)	-7(3)	18(5)	-19(6)
F(10D)	302(17)	89(7)	81(7)	11(5)	2(8)	-98(9)
F(11D)	238(13)	49(5)	102(7)	29(5)	8(8)	7(7)
F(12D)	213(12)	93(7)	79(6)	18(5)	68(7)	-32(7)

Table 5. Hydrogen coordinates ($\times 10^4$) and isotropic displacement parameters ($\text{Å}^2 \times 10^3$) for 1.

	x	y	z	U(eq)
H(2A1)	3139(8)	966(2)	4164(6)	41
H(2A2)	3936(8)	1210(2)	3570(6)	41
H(4A1)	5568(10)	932(3)	6038(7)	61
H(4A2)	4185(10)	791(3)	5727(7)	61
H(5A1)	6425(10)	605(3)	4952(7)	64
H(5A2)	5668(10)	361(3)	5573(7)	64
H(6A1)	3940(10)	340(3)	4459(7)	60
H(6A2)	5203(10)	221(3)	4026(7)	60
H(8A)	4371(10)	983(3)	2031(6)	61
H(1A)	6123(50)	954(19)	3548(46)	58
H(3A)	6586(14)	1218(23)	4926(28)	48
H(2B1)	10804(8)	1614(2)	6112(6)	40
H(2B2)	10105(8)	1361(2)	6741(6)	40
H(4B1)	8739(9)	2340(2)	6484(6)	48
H(4B2)	9908(9)	2237(2)	5930(6)	48
H(5B1)	8034(9)	2229(3)	4984(7)	56
H(5B2)	7401(9)	1967(3)	5627(7)	56
H(6B1)	9519(9)	1817(2)	4619(6)	52
H(6B2)	8116(9)	1667(2)	4427(6)	52
H(11B)	9952(10)	1536(3)	8317(6)	57
H(1B)	7443(41)	1447(2)	5970(65)	49
H(3B)	7895(51)	1893(2)	7364(64)	50
H(2C1)	6123(8)	2243(2)	-73(6)	39
H(2C2)	4667(8)	2162(2)	-363(6)	39
H(4C1)	4036(9)	1511(2)	-640(6)	50
H(4C2)	5171(9)	1241(2)	-528(6)	50
H(5C1)	6109(9)	1466(2)	-1792(6)	53
H(5C2)	4660(9)	1378(2)	-2089(6)	53
H(6C1)	5186(9)	1919(2)	-2624(6)	51
H(6C2)	4092(9)	1948(2)	-1957(6)	51
H(1C)	7427(23)	1968(23)	-1129(42)	56
H(3C)	7179(9)	1444(2)	-91(73)	55
H(2D1)	9184(9)	295(2)	721(6)	49
H(2D2)	7713(9)	306(2)	384(6)	49
H(4D1)	9873(9)	506(2)	2325(7)	56
H(4D2)	8798(9)	644(2)	2922(7)	56
H(5D1)	8430(11)	1116(3)	1999(8)	75
H(5D2)	9911(11)	1102(3)	2307(8)	75
H(6D1)	10401(11)	889(3)	934(7)	73
H(6D2)	9563(11)	1224(3)	753(7)	73
H(1D)	6848(33)	858(17)	609(63)	67
H(3D)	6724(41)	670(23)	2225(19)	55

The Crystallographically Dissimilar Structures for (88).

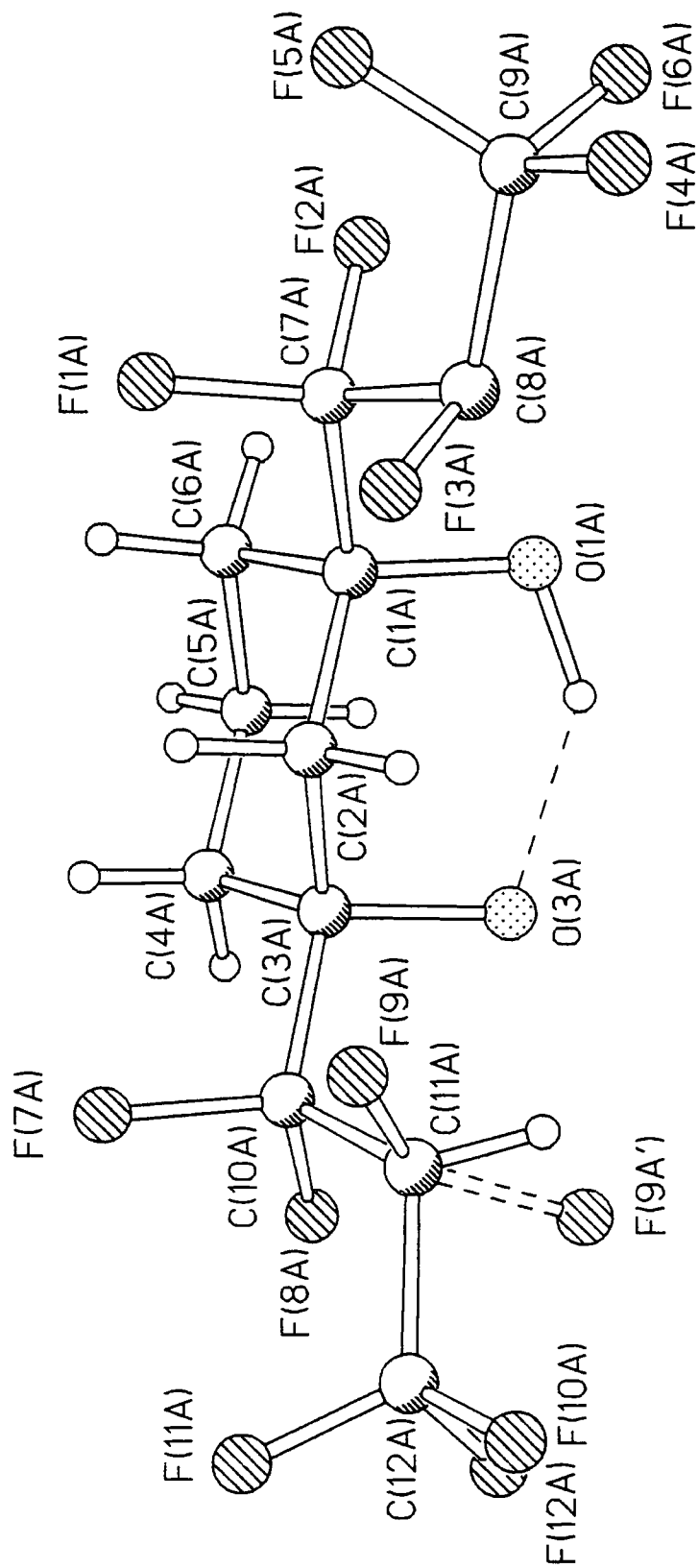

X-Ray Crystal Structure 4: 1,3-Di-(1,1,2,3,3,3-hexafluoropropyl)-cyclopentane-1,3-diol (**92**).

Identification code	97srv096
Empirical formula	C11 H10 F12 O2
Formula weight	402.19
Temperature	150(2) K
Wavelength	0.71073 Å
Crystal system	Monoclinic
Space group	P2(1)/n
Unit cell dimensions	a = 12.651(1) Å alpha = 90 deg. b = 10.436(1) Å beta = 103.69(1) deg. c = 22.301(2) Å gamma = 90 deg.
Volume	2860.7(4) Å ³
Z	8
Density (calculated)	1.868 g/cm ³
Absorption coefficient	0.228 mm ⁻¹
F(000)	1600
Crystal size	0.45 x 0.30 x 0.04 mm
Theta range for data collection	1.70 to 25.00 deg.
Index ranges	-16<=h<=14, -13<=k<=13, -28<=l<=28
Reflections collected	16913
Independent reflections	5038 [R(int) = 0.1069]
Observed reflections, I>2sigma(I)	2747
Absorption correction	None
Refinement method	Full-matrix least-squares on F ²
Data / restraints / parameters	4845 / 7 / 473
Goodness-of-fit on F ²	1.126
Final R indices [I>2sigma(I)]	R1 = 0.0964, wR2 = 0.1686
R indices (all data)	R1 = 0.1854, wR2 = 0.2267
Largest diff. peak and hole	0.537 and -0.402 e.Å ⁻³

Table 2. Atomic coordinates ($\times 10^4$) and equivalent isotropic displacement parameters ($\text{\AA}^2 \times 10^3$) for 1. $U(\text{eq})$ is defined as one third of the trace of the orthogonalized U_{ij} tensor.

	x	y	z	$U(\text{eq})$
O(1A)	2404(4)	2568(4)	2191(2)	43(1)
O(3A)	5439(3)	4616(4)	1979(2)	28(1)
C(1A)	3317(6)	3388(7)	2424(3)	41(2)
C(2A)	4381(6)	2859(7)	2295(3)	35(2)
C(3A)	4612(5)	3683(6)	1757(3)	29(2)
C(4A)	3549(5)	4399(7)	1497(3)	35(2)
C(5A)	3120(6)	4651(7)	2076(4)	44(2)
C(6A)	3524(8)	3383(10)	3147(5)	37(3)
C(7A)	2515(8)	3697(9)	3388(4)	38(3)
C(6A')	3069(18)	3950(21)	2990(10)	18(7)
C(7A')	2945(18)	2846(22)	3441(9)	23(8)
F(1A')	3934(18)	4702(20)	3249(9)	34(6)
F(2A')	2173(18)	4755(22)	2926(11)	41(7)
C(8A)	2681(9)	3508(11)	4071(4)	70(3)
C(9A)	5018(5)	2818(6)	1299(3)	31(2)
C(10A)	5343(7)	3489(8)	777(4)	47(2)
C(11A)	5852(7)	2673(8)	349(4)	46(2)
F(1A)	3842(3)	2131(4)	3399(2)	42(1)
F(2A)	4345(6)	4221(8)	3394(3)	40(2)
F(3A)	2255(6)	4951(7)	3221(5)	49(2)
F(4A)	2740(5)	2286(6)	4277(2)	86(2)
F(5A)	1820(5)	4040(6)	4205(3)	87(2)
F(6A)	3584(5)	4051(6)	4397(2)	94(2)
F(7A)	5934(3)	2161(3)	1614(2)	34(1)
F(8A)	4249(3)	1914(4)	1071(2)	41(1)
F(9A)	4423(4)	4027(5)	407(2)	67(2)
F(9A')	5762(35)	4607(30)	869(20)	34(17)
F(10A)	5242(4)	1624(5)	148(2)	68(2)
F(11A)	6806(4)	2201(5)	632(2)	67(2)
F(12A)	5942(5)	3296(6)	-137(2)	91(2)
O(1B)	10038(3)	2200(4)	2936(2)	30(1)
O(3B)	6951(4)	4112(4)	3095(2)	34(1)
C(1B)	9104(5)	2987(6)	2712(3)	26(2)
C(2B)	8070(5)	2404(6)	2871(3)	30(2)
C(3B)	7827(5)	3262(6)	3379(3)	26(2)
C(4B)	8867(5)	4013(6)	3630(3)	31(2)
C(5B)	9267(5)	4278(6)	3047(3)	29(2)
C(6B)	8920(6)	3065(7)	2009(3)	36(2)
C(7B)	9873(6)	3491(8)	1775(4)	50(2)
C(8B)	9729(8)	3477(10)	1067(4)	58(2)
C(9B)	7430(6)	2470(7)	3874(3)	33(2)
C(10B)	7342(7)	3206(8)	4451(4)	51(2)
C(11B)	6674(7)	2520(10)	4850(4)	58(2)
F(1B)	8639(3)	1809(4)	1753(2)	40(1)
F(2B)	8037(3)	3821(4)	1773(2)	44(1)
F(3B)	10108(4)	4717(4)	1972(2)	57(1)
F(4B)	9640(5)	2287(6)	853(3)	89(2)
F(5B)	10569(4)	3989(6)	926(2)	80(2)
F(6B)	8824(5)	4050(7)	766(2)	99(2)
F(7B)	8184(3)	1526(4)	4082(2)	48(1)
F(8B)	6489(3)	1855(4)	3597(2)	48(1)
F(9B)	6863(5)	4359(5)	4293(2)	74(2)
F(10B)	5648(4)	2436(7)	4594(2)	93(2)
F(11B)	7060(4)	1348(6)	4991(2)	75(2)

Table 3. Bond lengths [Å] and angles [deg] for 1.

O(1A)-C(1A)	1.434(8)	O(3A)-C(3A)	1.429(7)
C(1A)-C(6A')	1.49(2)	C(1A)-C(5A)	1.519(11)
C(1A)-C(2A)	1.542(10)	C(1A)-C(6A)	1.573(12)
C(2A)-C(3A)	1.561(9)	C(3A)-C(4A)	1.527(9)
C(3A)-C(9A)	1.539(9)	C(4A)-C(5A)	1.537(10)
C(6A)-F(2A)	1.369(10)	C(6A)-F(1A)	1.442(11)
C(6A)-C(7A)	1.533(14)	C(7A)-F(3A)	1.379(11)
C(7A)-C(8A)	1.501(12)	C(6A')-F(1A')	1.36(2)
C(6A')-F(2A')	1.39(2)	C(6A')-C(7A')	1.56(2)
C(7A')-F(1A)	1.38(2)	C(7A')-C(8A)	1.67(2)
C(8A)-F(5A)	1.317(12)	C(8A)-F(6A)	1.327(10)
C(8A)-F(4A)	1.352(11)	C(9A)-F(8A)	1.365(7)
C(9A)-F(7A)	1.386(7)	C(9A)-C(10A)	1.498(10)
C(10A)-F(9A')	1.28(3)	C(10A)-F(9A)	1.376(9)
C(10A)-C(11A)	1.530(10)	C(11A)-F(12A)	1.292(9)
C(11A)-F(11A)	1.318(9)	C(11A)-F(10A)	1.353(9)
O(1B)-C(1B)	1.428(7)	O(3B)-C(3B)	1.444(7)
C(1B)-C(5B)	1.531(9)	C(1B)-C(6B)	1.532(9)
C(1B)-C(2B)	1.558(9)	C(2B)-C(3B)	1.532(9)
C(3B)-C(4B)	1.520(9)	C(3B)-C(9B)	1.554(9)
C(4B)-C(5B)	1.529(9)	C(6B)-F(2B)	1.366(8)
C(6B)-F(1B)	1.441(8)	C(6B)-C(7B)	1.491(10)
C(7B)-F(3B)	1.363(9)	C(7B)-C(8B)	1.545(11)
C(8B)-F(5B)	1.294(10)	C(8B)-F(6B)	1.324(10)
C(8B)-F(4B)	1.325(10)	C(9B)-F(8B)	1.364(8)
C(9B)-F(7B)	1.373(8)	C(9B)-C(10B)	1.525(10)
C(10B)-F(9B)	1.356(9)	C(10B)-C(11B)	1.540(11)
C(11B)-F(10B)	1.291(9)	C(11B)-F(11B)	1.327(10)
C(11B)-F(12B)	1.332(10)		
O(1A)-C(1A)-C(6A')	103.2(9)	O(1A)-C(1A)-C(5A)	108.2(6)
C(6A')-C(1A)-C(5A)	92.8(10)	O(1A)-C(1A)-C(2A)	112.5(6)
C(6A')-C(1A)-C(2A)	131.7(11)	C(5A)-C(1A)-C(2A)	105.1(5)
O(1A)-C(1A)-C(6A)	107.1(6)	C(5A)-C(1A)-C(6A)	119.6(7)
C(2A)-C(1A)-C(6A)	104.4(7)	C(1A)-C(2A)-C(3A)	106.0(6)
O(3A)-C(3A)-C(4A)	107.7(5)	O(3A)-C(3A)-C(9A)	107.3(5)
C(4A)-C(3A)-C(9A)	116.0(6)	O(3A)-C(3A)-C(2A)	111.3(5)
C(4A)-C(3A)-C(2A)	104.6(5)	C(9A)-C(3A)-C(2A)	109.9(5)
C(3A)-C(4A)-C(5A)	102.7(6)	C(1A)-C(5A)-C(4A)	103.4(6)
F(2A)-C(6A)-F(1A)	107.9(8)	F(2A)-C(6A)-C(7A)	109.8(8)
F(1A)-C(6A)-C(7A)	103.7(7)	F(2A)-C(6A)-C(1A)	109.6(7)
F(1A)-C(6A)-C(1A)	111.5(7)	C(7A)-C(6A)-C(1A)	114.1(8)
F(3A)-C(7A)-C(8A)	111.5(9)	F(3A)-C(7A)-C(6A)	105.9(8)
C(8A)-C(7A)-C(6A)	113.6(9)	F(1A')-C(6A')-F(2A')	104(2)
F(1A')-C(6A')-C(1A)	106(2)	F(2A')-C(6A')-C(1A)	119(2)
F(1A')-C(6A')-C(7A')	110(2)	F(2A')-C(6A')-C(7A')	108(2)
C(1A)-C(6A')-C(7A')	109(2)	F(1A)-C(7A')-C(6A')	98(2)
F(1A)-C(7A')-C(8A)	128(2)	C(6A')-C(7A')-C(8A)	108(2)
F(5A)-C(8A)-F(6A)	110.3(9)	F(5A)-C(8A)-F(4A)	107.6(7)
F(6A)-C(8A)-F(4A)	104.2(9)	F(5A)-C(8A)-C(7A)	104.5(9)
F(6A)-C(8A)-C(7A)	113.3(8)	F(4A)-C(8A)-C(7A)	116.9(8)
F(5A)-C(8A)-C(7A')	134.8(11)	F(6A)-C(8A)-C(7A')	108.7(11)
F(4A)-C(8A)-C(7A')	83.6(10)	F(8A)-C(9A)-F(7A)	106.5(5)
F(8A)-C(9A)-C(10A)	109.6(6)	F(7A)-C(9A)-C(10A)	106.0(6)
F(8A)-C(9A)-C(3A)	109.4(5)	F(7A)-C(9A)-C(3A)	109.0(5)
C(10A)-C(9A)-C(3A)	115.9(6)	F(9A')-C(10A)-C(9A)	119(2)
F(9A)-C(10A)-C(9A)	107.9(6)	F(9A')-C(10A)-C(11A)	113(2)
F(9A)-C(10A)-C(11A)	105.9(7)	C(9A)-C(10A)-C(11A)	117.2(7)
F(12A)-C(11A)-F(11A)	109.7(7)	F(12A)-C(11A)-F(10A)	106.6(7)
F(11A)-C(11A)-F(10A)	104.0(7)	F(12A)-C(11A)-C(10A)	112.2(7)

F(11A)-C(11A)-C(10A)	112.5(7)	F(10A)-C(11A)-C(10A)	111.5(6)
O(1B)-C(1B)-C(5B)	109.3(5)	O(1B)-C(1B)-C(6B)	107.6(5)
C(5B)-C(1B)-C(6B)	115.0(5)	O(1B)-C(1B)-C(2B)	111.4(5)
C(5B)-C(1B)-C(2B)	104.8(5)	C(6B)-C(1B)-C(2B)	108.8(5)
C(3B)-C(2B)-C(1B)	105.5(5)	O(3B)-C(3B)-C(4B)	110.6(5)
O(3B)-C(3B)-C(2B)	107.6(5)	C(4B)-C(3B)-C(2B)	105.4(5)
O(3B)-C(3B)-C(9B)	107.2(5)	C(4B)-C(3B)-C(9B)	114.2(5)
C(2B)-C(3B)-C(9B)	111.7(5)	C(3B)-C(4B)-C(5B)	102.2(5)
C(4B)-C(5B)-C(1B)	102.8(5)	F(2B)-C(6B)-F(1B)	105.7(5)
F(2B)-C(6B)-C(7B)	110.4(6)	F(1B)-C(6B)-C(7B)	106.1(6)
F(2B)-C(6B)-C(1B)	109.7(6)	F(1B)-C(6B)-C(1B)	108.7(5)
C(7B)-C(6B)-C(1B)	115.8(6)	F(3B)-C(7B)-C(6B)	107.4(6)
F(3B)-C(7B)-C(8B)	107.6(7)	C(6B)-C(7B)-C(8B)	116.4(7)
F(5B)-C(8B)-F(6B)	110.5(8)	F(5B)-C(8B)-F(4B)	107.7(8)
F(6B)-C(8B)-F(4B)	104.6(8)	F(5B)-C(8B)-C(7B)	109.9(8)
F(6B)-C(8B)-C(7B)	113.1(7)	F(4B)-C(8B)-C(7B)	110.8(8)
F(8B)-C(9B)-F(7B)	106.1(5)	F(8B)-C(9B)-C(10B)	112.9(6)
F(7B)-C(9B)-C(10B)	105.1(6)	F(8B)-C(9B)-C(3B)	108.8(5)
F(7B)-C(9B)-C(3B)	107.8(5)	C(10B)-C(9B)-C(3B)	115.6(6)
F(9B)-C(10B)-C(9B)	110.1(6)	F(9B)-C(10B)-C(11B)	106.9(7)
C(9B)-C(10B)-C(11B)	114.3(7)	F(10B)-C(11B)-F(11B)	108.5(8)
F(10B)-C(11B)-F(12B)	108.7(8)	F(11B)-C(11B)-F(12B)	106.2(8)
F(10B)-C(11B)-C(10B)	114.1(8)	F(11B)-C(11B)-C(10B)	110.1(7)
F(12B)-C(11B)-C(10B)	108.9(8)		

Table 4. Anisotropic displacement parameters ($A^2 \times 10^3$) for 1.
 The anisotropic displacement factor exponent takes the form:
 $-2 \pi^2 [h^2 a^{*2} U_{11} + \dots + 2 h k a^* b^* U_{12}]$

	U11	U22	U33	U23	U13	U12
O(1A)	37(3)	39(3)	60(3)	-27(3)	26(3)	-21(2)
O(3A)	24(2)	23(2)	36(3)	-2(2)	4(2)	-4(2)
C(1A)	36(4)	43(5)	48(5)	-14(4)	21(4)	-21(4)
C(2A)	38(4)	34(4)	34(4)	2(3)	11(4)	-9(3)
C(3A)	32(4)	19(4)	38(4)	-9(3)	14(3)	-4(3)
C(4A)	23(4)	27(4)	51(5)	-2(3)	4(4)	-1(3)
C(5A)	26(4)	38(5)	71(6)	-22(4)	18(4)	-7(3)
C(6A)	27(6)	35(7)	48(7)	-3(5)	5(5)	-3(5)
C(7A)	42(6)	25(6)	50(7)	8(5)	18(5)	6(5)
C(8A)	79(8)	99(9)	34(5)	-1(5)	18(5)	-51(7)
C(9A)	27(4)	20(4)	44(4)	-3(3)	0(3)	-6(3)
C(10A)	51(5)	46(5)	51(5)	5(4)	25(4)	3(4)
C(11A)	46(5)	52(5)	45(5)	-15(4)	22(4)	-4(4)
F(1A)	42(3)	41(3)	46(3)	8(2)	15(2)	16(2)
F(2A)	31(4)	51(5)	37(4)	-8(3)	7(3)	-17(4)
F(3A)	50(4)	36(4)	68(6)	21(4)	28(4)	15(3)
F(4A)	113(5)	85(4)	75(4)	6(3)	57(4)	3(4)
F(5A)	89(4)	90(4)	83(4)	24(3)	21(4)	-5(4)
F(6A)	93(5)	134(5)	49(3)	-4(3)	6(3)	-41(4)
F(7A)	26(2)	26(2)	49(2)	5(2)	7(2)	6(2)
F(8A)	38(2)	34(2)	51(3)	-14(2)	12(2)	-10(2)
F(9A)	64(4)	84(4)	59(4)	32(3)	30(3)	36(3)
F(10A)	68(3)	84(4)	56(3)	-37(3)	23(3)	-9(3)
F(11A)	44(3)	98(4)	61(3)	-16(3)	19(3)	16(3)
F(12A)	141(6)	90(4)	65(4)	21(3)	66(4)	35(4)
O(1B)	18(2)	32(3)	39(3)	3(2)	3(2)	2(2)
O(3B)	36(3)	36(3)	30(3)	6(2)	5(2)	10(2)
C(1B)	23(4)	21(4)	34(4)	1(3)	5(3)	1(3)
C(2B)	29(4)	21(4)	36(4)	-2(3)	3(3)	2(3)
C(3B)	28(4)	23(4)	27(4)	2(3)	6(3)	4(3)
C(4B)	32(4)	28(4)	34(4)	-2(3)	11(3)	-1(3)
C(5B)	27(4)	22(4)	37(4)	3(3)	9(3)	5(3)
C(6B)	40(5)	26(4)	40(4)	7(3)	6(4)	10(3)
C(7B)	40(5)	48(5)	61(6)	5(4)	13(4)	2(4)
C(8B)	76(7)	68(7)	35(5)	-8(5)	24(5)	-6(6)
C(9B)	33(4)	36(4)	29(4)	10(3)	3(3)	4(4)
C(10B)	58(6)	57(6)	45(5)	15(4)	26(4)	12(4)
C(11B)	41(5)	87(8)	45(6)	3(5)	10(4)	-4(5)
F(1B)	46(3)	32(2)	44(2)	-2(2)	11(2)	-14(2)
F(2B)	46(3)	44(3)	41(3)	11(2)	7(2)	16(2)
F(3B)	62(3)	51(3)	65(3)	-18(2)	32(3)	-31(2)
F(4B)	115(5)	96(5)	74(4)	-13(3)	55(4)	-32(4)
F(5B)	77(4)	117(5)	59(3)	1(3)	42(3)	-21(3)
F(6B)	77(4)	174(7)	46(3)	40(4)	16(3)	20(4)
F(7B)	42(3)	48(3)	55(3)	21(2)	11(2)	8(2)
F(8B)	33(2)	44(3)	64(3)	7(2)	9(2)	-8(2)
F(9B)	108(4)	64(4)	64(3)	4(3)	48(3)	21(3)
F(10B)	35(3)	178(6)	69(4)	33(4)	20(3)	-1(4)
F(11B)	70(4)	92(4)	65(4)	31(3)	22(3)	-1(3)
F(12B)	96(4)	116(5)	58(4)	4(3)	40(3)	-8(4)

Table 5. Hydrogen coordinates ($\times 10^4$) and isotropic displacement parameters ($\text{\AA}^2 \times 10^3$) for 1.

	x	y	z	U(eq)
H(1A)	2503 (4)	2162 (4)	1882 (2)	51
H(3A)	5907 (3)	4313 (4)	2280 (2)	34
H(2A1)	4286 (6)	1948 (7)	2171 (3)	45
H(2A2)	4990 (6)	2924 (7)	2666 (3)	45
H(4A1)	3034 (5)	3871 (7)	1193 (3)	45
H(4A2)	3685 (5)	5212 (7)	1300 (3)	45
H(5A1)	2335 (6)	4860 (7)	1963 (4)	57
H(5A2)	3520 (6)	5363 (7)	2324 (4)	57
H(7A)	1926 (8)	3094 (9)	3183 (4)	49
H(7A')	2286 (18)	2343 (22)	3234 (9)	30
H(10A)	5857 (7)	4197 (8)	951 (4)	62
H(1B)	10553 (3)	2656 (4)	3132 (2)	36
H(3B)	6879 (4)	4108 (4)	2710 (2)	41
H(2B1)	7451 (5)	2403 (6)	2504 (3)	38
H(2B2)	8208 (5)	1513 (6)	3023 (3)	38
H(4B1)	9399 (5)	3501 (6)	3934 (3)	40
H(4B2)	8717 (5)	4821 (6)	3827 (3)	40
H(5B1)	10045 (5)	4526 (6)	3153 (3)	37
H(5B2)	8838 (5)	4963 (6)	2793 (3)	37
H(7B)	10509 (6)	2940 (8)	1968 (4)	64
H(10B)	8093 (7)	3353 (8)	4710 (4)	66

The Crystallographically Dissimilar Structures for (92).

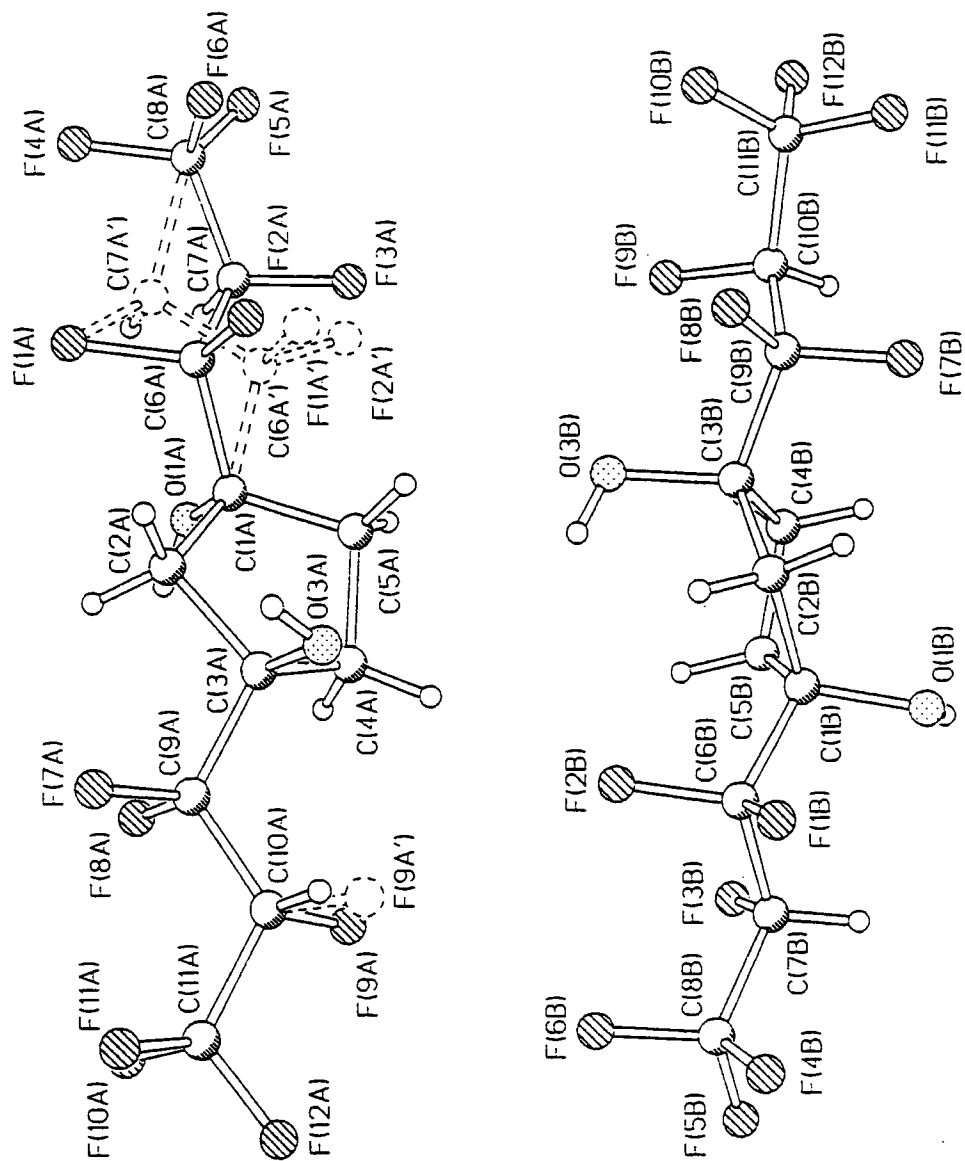

**Appendix E: Requirements of the
Board of Studies.**

The Board of Studies in Chemistry requires that each postgraduate research thesis contains an appendix listing:-

i. All research colloquia, seminars and lectures arranged by both the Department of Chemistry and Durham University Chemical Society during the period of the Author's residence as a postgraduate student.

ii. Details of postgraduate induction courses.

iii. All research conferences attended and papers presented by the Author during the period of residence as a postgraduate student.

Appendix E.i.: Research Colloquia, Seminars and Lectures.

1995

- October 11 Prof. P. Lugar, Frei Univ Berlin, FRG.
Low Temperature Crystallography.
- October 13 Prof. R. Schmutzler, Univ Braunschweig, FRG.
Calixarene-Phosphorus Chemistry: A New Dimension in Phosphorus Chemistry.
- October 18 Prof. A. Alexakis, Univ. Pierre et Marie Curie, Paris.*.
Synthetic and Analytical Uses of Chiral Diamines
- October 25 Dr.D.Martin Davies, University of Northumbria.
Chemical reactions in organised systems.
- November 1 Prof. W. Motherwell, UCL London.*.
New Reactions for Organic Synthesis
- November 3 Dr B. Langlois, University Claude Bernard-Lyon.*
Radical Anionic and Psuedo Cationic Trifluoromethylation.
- November 8 Dr. D. Craig, Imperial College, London.*
New Stategies for the Assembly of Heterocyclic Systems.
- November 15 Dr Andrea Sella, UCL, London.
Chemistry of Lanthanides with Polypyrazoylborate Ligands.

- November 17 Prof. David Bergbreiter, Texas A&M, USA.*
Design of Smart Catalysts, Substrates and Surfaces from Simple
Polymers.
- November 22 Prof. I Soutar, Lancaster University.
A Water of Glass? Luminescence Studies of Water-Soluble Polymers.
- November 29 Prof. Dennis Tuck, University of Windsor, Ontario, Canada.
New Indium Coordination Chemistry.
- December 8 Professor M.T. Reetz, Max Planck Institut, Mulheim.
Perkin Regional Meeting.

1996

- January 10 Dr Bill Henderson, Waikato University, NZ.
Electrospray Mass Spectrometry - a new sporting technique.
- January 17 Prof. J. W. Emsley, Southampton University.*
Liquid Crystals: More than Meets the Eye.
- January 24 Dr Alan Armstrong, Nottingham University.*
Alkene Oxidation and Natural Product Synthesis.
- January 31 Dr J. Penfold, Rutherford Appleton Laboratory.
Soft Soap and Surfaces.
- February 7 Dr R.B. Moody, Exeter University.
Nitrosations, Nitrations and Oxidations with Nitrous Acid.
- February 12 Dr Paul Pringle, University of Bristol.
Catalytic Self-Replication of Phosphines on Platinum(O).
- February 14 Dr J. Rohr, Univ Gottingen, FRG.
Goals and Aspects of Biosynthetic Studies on Low Molecular Weight
Natural Products.
- February 21 Dr C R Pulham, Univ. Edinburgh.
Heavy Metal Hydrides - an exploration of the chemistry of stannanes
and plumbanes.

- February 28 Prof. E. W. Randall, Queen Mary & Westfield College.
New Perspectives in NMR Imaging.
- March 6 Dr Richard Whitby, Univ of Southampton.*
New approaches to chiral catalysts: Induction of planar and metal centred asymmetry.
- March 7 Dr D.S. Wright, University of Cambridge.
Synthetic Applications of Me₂N-p-Block Metal Reagents.
- March 12 RSC Endowed Lecture - Prof. V. Balzani, Univ of Bologna.
Supramolecular Photochemistry.
- March 13 Prof. Dave Garner, Manchester University.*
Mushrooming in Chemistry.
- April 30 Dr L.D.Pettit, Chairman, IUPAC Commission of Equilibrium Data.
pH-metric studies using very small quantities of uncertain purity.

1996

- October 9 Professor G. Bowmaker, University Auckland, NZ.
Coordination and Materials Chemistry of the Group 11 and Group 12 Metals : Some Recent Vibrational and Solid State NMR Studies.
- October 14 Professor A. R. Katritzky, University of Gainesville, University of Florida, USA.*
Recent Advances in Benzotriazole Mediated Synthetic Methodology.
- October 16 Professor Ojima, Guggenheim Fellow, State University of New York at Stony Brook.*
Silylformylation and Silylcarbocyclisations in Organic Synthesis.
- October 22 Professor Lutz Gade, Univ. Wurzburg, Germany.*
Organic transformations with Early-Late Heterobimetallics: Synergism and Selectivity.

- October 22 Professor B. J. Tighe, Department of Molecular Sciences and Chemistry, University of Aston.
Making Polymers for Biomedical Application - can we meet Nature's Challenge? Joint lecture with the Institute of Materials
- October 23 Professor H. Ringsdorf (Perkin Centenary Lecture), Johannes Gutenberg-Universität, Mainz, Germany.
Function Based on Organisation.
- October 29 Professor D. M. Knight, Department of Philosophy, University of Durham.
The Purpose of Experiment - A Look at Davy and Faraday.
- October 30 Dr Phillip Mountford, Nottingham University.
Recent Developments in Group IV Imido Chemistry.
- November 6 Dr Melinda Duer, Chemistry Department, Cambridge.
Solid-state NMR Studies of Organic Solid to Liquid-crystalline Phase Transitions.
- November 12 Professor R. J. Young, Manchester Materials Centre, UMIST.*
New Materials - Fact or Fantasy? Joint Lecture with Zeneca & RSC.
- November 13 Dr G. Resnati, Milan.*
Perfluorinated Oxaziridines: Mild Yet Powerful Oxidising Agents.
- November 18 Professor G. A. Olah, University of Southern California, USA.*
Crossing Conventional Lines in my Chemistry of the Elements.
- November 19 Professor R. E. Grigg, University of Leeds.*
Assembly of Complex Molecules by Palladium-Catalysed Queuing Processes.
- November 20 Professor J. Earnshaw, Department of Physics, Belfast.
Surface Light Scattering: Ripples and Relaxation.
- November 27 Dr Richard Templer, Imperial College, London.
Molecular Tubes and Sponges.

- December 3 Professor D. Phillips, Imperial College, London.
"A Little Light Relief"
- December 4 Professor K. Muller-Dethlefs, York University.
Chemical Applications of Very High Resolution ZEKE Photoelectron Spectroscopy.
- December 11 Dr Chris Richards, Cardiff University.*
Stereochemical Games with Metallocenes.

1997

- January 15 Dr V. K. Aggarwal, University of Sheffield.*
Sulfur Mediated Asymmetric Synthesis.
- January 16 Dr Sally Brooker, University of Otago, NZ.
Macrocycles: Exciting yet Controlled Thiolate Coordination Chemistry.
- January 21 Mr D. Rudge, Zeneca Pharmaceuticals.*
High Speed Automation of Chemical Reactions.
- January 22 Dr Neil Cooley, BP Chemicals, Sunbury.
Synthesis and Properties of Alternating Polyketones.
- January 29 Dr Julian Clarke, UMIST.
What can we learn about polymers and biopolymers from computer-generated nanosecond movie-clips?
- February 4 Dr A. J. Banister, University of Durham.*
From Runways to Non-metallic Metals - A New Chemistry Based on Sulphur.
- February 5 Dr A. Haynes, University of Sheffield.
Mechanism in Homogeneous Catalytic Carbonylation.
- February 12 Dr Geert-Jan Boons, University of Birmingham.*
New Developments in Carbohydrate Chemistry.

- February 18 Professor Sir James Black, Foundation/King's College London.*
My Dialogues with Medicinal Chemists.
- February 19 Professor Brian Hayden, University of Southampton.
The Dynamics of Dissociation at Surfaces and Fuel Cell Catalysts.
- February 25 Professor A. G. Sykes, University of Newcastle.
The Synthesis, Structures and Properties of Blue Copper Proteins.
- February 26 Dr Tony Ryan, UMIST.*
Making Hairpins from Rings and Chains.
- March 4 Professor C. W. Rees, Imperial College.*
Some Very Heterocyclic Chemistry.
- March 5 Dr J. Staunton FRS, Cambridge University.*
Tinkering with biosynthesis: towards a new generation of antibiotics.
- March 11 Dr A. D. Taylor, ISIS Facility, Rutherford Appleton Laboratory.
Expanding the Frontiers of Neutron Scattering.
- March 19 Dr Katharine Reid, University of Nottingham.
Probing Dynamical Processes with Photoelectrons.
- October 8 Prof. E. Atkins, Department of Physics, University of Bristol.
Advances in the control of architecture for polyamides: from nylons to genetically engineered silks to monodisperse oligoamides.
- October 15 Dr. R. Mark Ormerod, Department of Chemistry, Keele University.
Studying catalysts in action.
- October 21 Prof. A. F. Johnson, IRC, Leeds.
Reactive processing of polymers: science and technology.
- October 22 Prof. R.J. Puddephatt (RSC Endowed Lecture), University of Western Ontario.
Organoplatinum chemistry and catalysis.

- October 23 Prof. M.R. Bryce, University of Durham, Inaugural Lecture.*
New Tetrathiafulvalene Derivatives in Molecular, Supramolecular and Macromolecular Chemistry: controlling the electronic properties of organic solids
- October 29 Prof. Bob Peacock, University of Glasgow.*
Probing chirality with circular dichroism.
- October 28 Prof. A P de Silva, The Queen's University, Belfast.
Luminescent signalling systems.
- November 5 Dr Mimi Hii, Oxford University.*
Studies of the Heck reaction.
- November 11 Prof. V Gibson, Imperial College, London.*
Metallocene polymerisation.
- November 12 Dr Jeremy Frey, Department of Chemistry, Southampton University.
Spectroscopy of liquid interfaces: from bio-organic chemistry to atmospheric chemistry.
- November 19 Dr Gareth Morris, Department of Chemistry, Manchester Univ.
Pulsed field gradient NMR techniques: Good news for the Lazy and DOSY.
- November 20 Dr Leone Spiccia, Monash University, Melbourne, Australia.
Polynuclear metal complexes.
- November 25 Dr R. Withnall, University of Greenwich.
Illuminated molecules and manuscripts.
- November 26 Prof. R.W. Richards, University of Durham, Inaugural Lecture.*
A random walk in polymer science.
- December 2 Dr C.J. Ludman, University of Durham.*
Explosions.
- December 3 Prof. A.P. Davis, Department. of Chemistry, Trinity College Dublin.
Steroid-based frameworks for supramolecular chemistry.

- December 10 Sir Gordon Higginson, former Professor of Engineering in Durham and retired Vice-Chancellor of Southampton Univ.
1981 and all that.
- December 10 Prof. Mike Page, Department of Chemistry, University of Huddersfield.*
The mechanism and inhibition of beta-lactamases.
- October 27 Prof. Warren Roper FRS. University of Auckland, New Zealand
- 1998
- January 14 Prof. David Andrews, University of East Anglia.
Energy transfer and optical harmonics in molecular systems.
- January 20 Prof. J. Brooke, University of Lancaster.
What's in a formula? Some chemical controversies of the 19th century.
- January 21 Prof. David Cardin, University of Reading.
- January 27 Prof. Richard Jordan, Dept. of Chemistry, Univ. of Iowa, USA.
Cationic transition metal and main group metal alkyl complexes in olefin polymerisation.
- January 28 Dr Steve Rannard, Courtaulds Coatings (Coventry).
The synthesis of dendrimers using highly selective chemical reactions.
- February 3 Dr J. Beacham, ICI Technology.*
The chemical industry in the 21st century.
- February 4 Prof. P. Fowler, Department of Chemistry, Exeter University.*
Classical and non-classical fullerenes.
- February 11 Prof. J. Murphy, Dept of Chemistry, Strathclyde University.*
- February 17 Dr S. Topham, ICI Chemicals and Polymers.
Perception of environmental risk; The River Tees, two different rivers.
- February 18 Prof. Gus Hancock, Oxford University.
Surprises in the photochemistry of tropospheric ozone.

- February 24 Prof. R. Ramage, University of Edinburgh.
The synthesis and folding of proteins.
- February 25 Dr C. Jones, Swansea University.
Low coordination arsenic and antimony chemistry.
- March 4 Prof. T.C.B. McLeish, IRC of Polymer Science Technology, Leeds University.
The polymer physics of pyjama bottoms (or the novel rheological characterisation of long branching in entangled macromolecules).
- March 11 Prof. M.J. Cook, Dept of Chemistry, UEA.*
How to make phthalocyanine films and what to do with them.
- March 17 Prof. V. Rotello, University of Massachusetts, Amherst.
The interplay of recognition & redox processes - from flavoenzymes to devices.
- March 18 Dr John Evans, Oxford University.
Materials which contract on heating (from shrinking ceramics to bullet proof vests).

* denotes lectures attended

Appendix E.ii.: Postgraduate Induction Courses.

These courses consist of a series of one-hour lectures on the services available within the department.

Departmental Organisations -	Dr. E. J. F. Ross
Safety Matters -	Dr. G. M. Brooke
Electrical Appliances -	Mr. B. T. Barker
Library Facilities -	Mrs. M. Hird
Mass Spectroscopy -	Dr. M. Jones
NMR Spectroscopy -	Dr. A. Kenwright
Glass Blowing Techniques -	Mr. R. Hart and Mr. G Haswell.

Appendix E.iii.: Research Conferences Attended.

- | | |
|--------------|--|
| May 1997 | 21st Century Heterocyclic Chemistry, University of Sunderland, Sunderland, England. |
| August 1997. | 15th International Symposium on Fluorine Chemistry, University of British Columbia, Vancouver, Canada. |

Appendix F: References.

1. R. E. Banks, *J. Fluorine Chem.*, 1998, **87**, 1.
2. R. D. Chambers, *Fluorine in organic chemistry*, Wiley-Interscience, New York, 1973.
3. D. O'Hagan and H. S. Rzepa, *J. Chem. Soc., Chem. Commun.*, 1997, 645.
4. B. E. Smart, in *Molecular Structure and Energetics*, ed. J. F. Liebman and A. Greenberg, VCH Publishers, Deefield Beach, 1986, vol. 3, p. 141.
5. D. B. Harper and D. O'Hagan, *Nat. Prod. Rep.*, 1994, **11**, 123.
6. M. Meyer and D. O'Hagan, *Chemistry in Britain*, 1992, **28**, 785.
7. R. E. Banks, Eds., *Preparation, Properties and Industrial Applications of Organofluorine Compounds.*, Ellis Horwood, Chichester, 1982.
8. J. Fossey, D. Lefort and J. Sorba, *Free Radicals in Organic Chemistry*, Wiley and Sons, New York, 1995.
9. B. Giese, *Radicals in Organic Synthesis: Formation of Carbon-Carbon Bonds.*, Pergamon Press, Oxford, 1986.
10. W. B. Motherwell and D. Crich, *Free Radical Chain Reactions in Organic Synthesis*, Academic Press Ltd., London, 1992.
11. D. F. McMillen and D. M. Golden, *Ann. Rev. Phys. Chem.*, 1982, **33**, 493.
12. A. K. Joel, Ph.D. Thesis, Univ. of University of durham, 1992.
13. W. R. J. Dolbier, *Chem. Rev.*, 1996, **96**, 1557.
14. X.-K. Jiang, X.-Y. Li and K.-Y. Wang, *J. Org. Chem.*, 1989, **54**, 5648.
15. R. V. Lloyd, in *Chemical Kinetics of Small Organic Radicals*, ed. Z. B. Alfassi, Boca Raton, Florida, vol. 1, p. 1.
16. P. J. Krusic and R. C. Bingham, *J. Am. Chem. Soc.*, 1976, **98**, 230.
17. F. Bernardi, W. Cherry, S. Shaik and N. D. Epiotis, *J. Am. Chem. Soc.*, 1978, **100**, 1352.
18. L. Pauling, *J. Chem. Phys.*, 1969, **51**, 2767.
19. K. V. Scherer, T. Ono, K. Yamanouchi, R. Fernandez, P. Henderson and H. Goldwhite, *J. Am. Chem. Soc.*, 1985, **107**, 718.
20. G. S. Hammond, *J. Am. Chem. Soc.*, 1955, **77**, 334.
21. M. N. Paddon-Row, N. G. Robinson and K. N. Houk, *J. Am. Chem. Soc.*, 1982, **104**, 7162.
22. R. D. Chambers and R. H. Mobbs, *Adv. Fluorine Chem.*, 1965, **4**, 50.
23. M. Stacey, J. C. Tatlow and A. G. Sharpe, Eds., *Advances in Fluorine Chemistry*, Butterworhs, London, 1960.
24. M. R. Bryce and R. D. Chambers, in *Comprehensive Carbanion Chemistry*, ed. E. Buncl and T. Durst, Elsevier, Amsterdam, 1987.
25. D. A. Dixon and B. E. Smart, *J. Phys. Chem.*, 1989, **93**, 7772.
26. J. M. Tedder and J. C. Walton, *Acc. Chem. Res.*, 1976, **9**, 183.
27. J. M. Tedder and J. C. Walton, *Tetrahedron*, 1980, **36**, 701.
28. B. Giese, *Angew. Chem. Int. Ed. Engl.*, 1983, **22**, 753.

29. I. Fleming, *Frontier Orbitals in Organic Reactions*, Wiley, London, 1976.
30. B. E. Smart, in *The Chemistry of Functional Groups Supplement D*, ed. S. Patai and Z. Rapport, Wiley, Chichester, 1983, vol. 1.
31. M. R. Bryce, R. D. Chambers and G. Taylor, *J. Chem. Soc. Perkin Trans. I*, 1984, 509.
32. J. D. Lazerte and R. J. Koshar, *J. Am. Chem. Soc.*, 1955, **77**, 910.
33. M. S. Kharasch, W. H. Urry and B. M. Kuderna, *J. Org. Chem.*, 1949, **14**, 248.
34. H. Muramatsu, J. Inukai and T. Ueda, *Bull. Chem. Soc. Jpn.*, 1967, **40**, 903.
35. R. N. Haszeldine, R. Rowland, R. P. Sheppard and A. E. Tipping, *J. Fluorine Chem.*, 1985, **28**, 291.
36. O. Paleta, V. Cirkva and J. Kvicala, *Macromol. Symp.*, 1994, **82**, 111.
37. S. N. Dunn, Ph.D. Thesis, Univ. of Durham, 1996.
38. V. Cirkva, R. Polak and O. Paleta, *J. Fluorine Chem.*, 1996, **80**, 135.
39. O. Paleta, presented at the Abst. Pap., 14th Int. Symp. Fluorine Chem., Yokohama, Japan, 1994.
40. J. F. Harris and F. W. Stacey, *J. Am. Chem. Soc.*, 1961, **83**, 840.
41. R. Fuss, Ph.D. Thesis, Univ. of University of Durham, 1989.
42. T. Davies, R. N. Haszeldine and A. E. Tipping, *J. Chem. Soc., Perkin Trans. I*, 1983, 109.
43. R. C. H. Spink, Ph.D. Thesis, Univ. of Durham, 1996.
44. R. N. Haszeldine, R. Rowland, A. E. Tipping and G. Tyrrell, *J. Fluorine Chem.*, 1982, **21**, 253.
45. R. D. Chambers, L. D. Proctor and G. Caporiccio, *J. Fluorine Chem.*, 1995, **70**, 241.
46. C. M. Starks, *Free Radical Telomerisation*, Academic Press, New York, 1974.
47. M. Hauptschein, M. Braid and F. E. Lawlor, *J. Am. Chem. Soc.*, 1957, **79**, 2549.
48. V. Cirkva, O. Paleta, B. Ameduri and B. Boutevin, *J. Fluorine Chem.*, 1995, **75**, 87.
49. G. C. Aspey, R. D. Chambers, M. J. Salisbury and G. Moggi, *J. Fluorine Chem.*, 1988, **40**, 261.
50. V. Tortelli and C. Tonnelli, *J. Fluorine Chem.*, 1990, **47**, 199.
51. R. N. Haszeldine, C. M. Raynor and A. E. Tipping, *J. Chem. Soc., Perkin Trans. I*, 1982, 2219.
52. R. N. Haszeldine, A. J. Mitchinson, R. Rowland and A. E. Tipping, *J. Chem. Soc., Perkin Trans. I*, 1976, 517.
53. H. Muramatsu and K. Inukai, *J. Org. Chem.*, 1965, **30**, 544 ; 2546.
54. H. Kimoto, H. Muramatsu and K. Inukai, *Bull. Chem. Soc. Jpn.*, 1975, **48**, 1335.
55. R. D. Chambers, B. Grievson, F G Drakesmith and R L Powell, *J. Fluorine Chem.*, 1985, **29**, 323.

56. R. D. Chambers, B. Grievson and N. Kelly, *J. Chem. Soc. Perkin Trans. I*, 1985, 2209.
57. T. N. Abroskina, A. D. Sorokin, R. V. Kudryavtsev and Y. A. Cherburkov, *Izv. Akad. Nauk. SSSR.*, 1974, **8**, 1823.
58. *U.S. Pat no. 3,927,129.*
59. *U.S. Pat no. 3,816,286.*
60. H. Kimoto, H. Murumatsu and K. Inukai, *Nippon Kagaku Kaishi*, 1976, 1787.
61. H. Muramatsu, S. Moriguchi and K. Inukai, *J. Org. Chem.*, 1966, **31**, 1306.
62. R. D. Chambers and B. Grievson, *J. Chem. Soc. Perkin Trans. I*, 1985, 2215.
63. R. D. Chambers, S. L. Jones, S. J. Mullins, A. Swales, P. Telford and M. L. H. West, *Acc. Symp. Ser.*, 1991, **456**, 68.
64. O. Paleta, V. Cirkva and J. Kvicala, *J. Fluorine Chem.*, 1996, **80**, 125.
65. J. P. S. Badyal, R. D. Chambers and A. K. Joel, *J. Fluorine Chem.*, 1993, **60**, 297.
66. G. W. Gokel, *Chem. Soc. Rev.*, 1992, **21**, 39.
67. R. L. Kirchmeier, J. Chen, Y.-F. Zhang, X. Zheng, A. Vij, D. Wingate, D. Meng, K. White and J. M. Shreeve, *Inorg. Chem.*, 1996, **35**, 1590.
68. J. M. Shreeve, J. Chen and R. L. Kirchmeier, *Inorg. Chem.*, 1996, **35**, 6676.
69. S. L. Jones, Ph.D. Thesis, Univ. of University of Durham, 1987.
70. O. Paleta, J. Kvicala, Z. Budkova and H.-J. Timpe, *Collect. Czech. Chem. Commun.*, 1995, **60**, 636.
71. E. F. Mooney, *An Introduction to ¹⁹F NMR Spectroscopy*, Heyden-Sadtler, London, 1970.
72. J. W. Emsley, L. Phillips and V. Wray, *Fluorine Coupling Constants*, Pergamon Press, Oxford, 1977.
73. D. H. Williams and I. Fleming, *Spectroscopic Methods in Organic Chemistry*, McGraw-Hill, London, 1995.
74. E. Breitmaier, G. Haas and M. Voelter, *Atlas of Carbon-13 NMR Data*, Heyden, London, 1979.
75. T. L. Ho, *Tandem Organic Reactions*, Wiley Interscience, New York, 1992.
76. R. K. Mackie, D. M. Smith and R. A. Aitken, *Guidebook to Organic Synthesis*, Longman Scientific and Technical, New York, 1990.
77. R. D. Chambers, N. Kelly and J. W. Emsley, *J. Fluorine Chem.*, 1978, **12**, 49.
78. R. F. Stockel and M. T. Beachem, *J. Org. Chem.*, 1967, **32**, 1658.
79. P. Sykes, *Mechanism in Organic Chemistry*, Longman Scientific and Technical, New York, 1986.
80. C. Thibaudeau, J. Plavec and J. Chattopadhyaya, *J. Org. Chem.*, 1998, **63**, 4967.
81. A. P. Swales, Ph.D. Thesis, Univ. of University of Durham, 1989.
82. W. Dmowski, *J. Fluorine Chem.*, 1980, **15**, 299.
83. H. Gunther, in *NMR Spectroscopy*, John Wiley, 1980.

84. J. K. M. Sanders and B. K. Hunter, *Modern NMR Spectroscopy: A Guide for Chemists.*, Oxford University Press, New York, 1987.
85. A. Bondi, *J. Phys. Chem.*, 1964, **68**, 441.
86. D. A. Dixon, N. Matsuzawa and S. C. Walker, *J. Phys. Chem.*, 1992, **96**, 10740.
87. R. F. Hoffmann and R. A. Olafson, *J. Am. Chem. Soc.*, 1966, **88**, 943.
88. R. C. Bingham, *J. Am. Chem. Soc.*, 1976, **98**, 535.
89. R. C. Larock, *Comprehensive Organic Transformations*, John Wiley, 1989.
90. W. S. Allen and S. Bernstein, *J. Am. Chem. Soc.*, 1955, **77**, 1028.
91. A. Schwartz and P. Madan, *J. Org. Chem.*, 1986, **51**, 5463.
92. N. Campbell and D. Kidd, *J. Chem. Soc.*, 1954, **2**, 2154.
93. J. McMurry, *Organic Chemistry*, Brooks/Cole, California, 1992.
94. A. L. Henne and S. Kaye, *J. Am. Chem. Soc.*, 1950, **72**, 3369.
95. P. C. Myhre and G. C. Andrews, *J. Am. Chem. Soc.*, 1970, **92**, 7595.
96. J. G. Riess and M. LeBlanc, *Angew. Chem., Int. Ed. Engl.*, 1978, **17**, 621.
97. F. Camps, J. Coll, A. Messeguer and M. A. Pericas, *Tet. Lett.*, 1981, **22**, 3895.
98. F. Fringuelli, R. Germani, F. Pizzo and G. Savelli, *Tet. Lett.*, 1989, **30**, 1427.
99. R. E. Parker and N. S. Issacs, *Chem. Rev.*, 1959, **59**, 737.
100. D. E. Seeger, P. M. Lahti, A. R. Rossi and J. A. Berson, *J. Am. Chem. Soc.*, 1986, **108**, 1251.
101. R. P. Holysz, *J. Am. Chem. Soc.*, 1953, **75**, 4432.
102. M. Hauptschein and R. E. Osterling, *J. Am. Chem. Soc.*, 1960, **82**, 2868.
103. G. E. Carr, R. D. Chambers, T. F. Holmes and D. G. Parker, *J. Chem. Soc. Perkin Trans. I*, 1988, 921.
104. Q.-Y. Chen and S.-W. Wu, *J. Chem. Soc. Perkin Trans. I*, 1989, 2385.
105. J. M. Whittemore, A. P. Stefani and M. Szwarc, *J. Am. Chem. Soc.*, 1962, **84**, 3799.
106. M. Tordeux, B. Langiois and C. Wakselman, *J. Chem. Soc. Perkin Trans. I*, 1990, 2293.
107. A. Gregorcic and M. Zupan, *J. Org. Chem.*, 1979, **44**, 4120.
108. S. W. Charles and E. Whittle, *Trans. Faraday Soc.*, 1960, **56**, 794.
109. E. S. Huyser and E. Bedard, *J. Org. Chem.*, 1965, **29**, 1588.