



## Durham E-Theses

---

# *Nonparametric Predictive Inference for System Reliability*

ABOALKHAIR, AHMAD, MOHAMMAD, ABDALMONEM

### How to cite:

---

ABOALKHAIR, AHMAD, MOHAMMAD, ABDALMONEM (2012) *Nonparametric Predictive Inference for System Reliability*, Durham theses, Durham University. Available at Durham E-Theses Online: <http://etheses.dur.ac.uk/3918/>

### Use policy

---

The full-text may be used and/or reproduced, and given to third parties in any format or medium, without prior permission or charge, for personal research or study, educational, or not-for-profit purposes provided that:

- a full bibliographic reference is made to the original source
- a [link](#) is made to the metadata record in Durham E-Theses
- the full-text is not changed in any way

The full-text must not be sold in any format or medium without the formal permission of the copyright holders.

Please consult the [full Durham E-Theses policy](#) for further details.

# Nonparametric Predictive Inference for System Reliability

Ahmad M. Aboalkhair

A thesis presented for the degree of  
Doctor of Philosophy



Department of Mathematical Sciences  
University of Durham  
England

May 2012

## *Dedicated*

### *To my father*

*Who has been a great source of motivation and endless support in my life  
Thank you for all your sacrifices for me to help me become what I am now*

### *To the soul of my mother*

*For all unlimited love, sacrifices, inspiration, prayers and faith in me  
I wish I could kiss her hand and tell her how much I appreciate that*

### *To my wife*

*For her endless love, support, encouragement and belief in me  
Thank you for being there during the hardest of times*

### *To my lovely children*

*for lighting up my life with their smile*

### *To my brothers and sisters*

*for all the love, prayers and best wishes throughout my life*

# Nonparametric Predictive Inference for System Reliability

Ahmad M. Aboalkhair

Submitted for the degree of Doctor of Philosophy  
May 2012

## Abstract

This thesis provides a new method for statistical inference on system reliability on the basis of limited information resulting from component testing. This method is called Nonparametric Predictive Inference (NPI). We present NPI for system reliability, in particular NPI for  $k$ -out-of- $m$  systems, and for systems that consist of multiple  $k^i$ -out-of- $m^i$  subsystems in series configuration. The algorithm for optimal redundancy allocation, with additional components added to subsystems one at a time is presented. We also illustrate redundancy allocation for the same system in case the costs of additional components differ per subsystem.

Then NPI is presented for system reliability in a similar setting, but with all subsystems consisting of the same single type of component. As a further step in the development of NPI for system reliability, where more general system structures can be considered, nonparametric predictive inference for reliability of voting systems with multiple component types is presented. We start with a single voting system with multiple component types, then we extend to a series configuration of voting subsystems with multiple component types. Throughout this thesis we assume information from tests of  $n_t$  components of type  $t$ .

# Declaration

The work in this thesis is based on research carried out at the Department of Mathematical Sciences, Durham University, UK. No part of this thesis has been submitted elsewhere for any other degree or qualification and it is all the author's original work unless referenced to the contrary in the text.

**Copyright © 2012 by Ahmad M. Aboalkhair.**

“The copyright of this thesis rests with the author. No quotations from it should be published without the author's prior written consent and information derived from it should be acknowledged”.

# Acknowledgements

First and foremost, all thanks and praise to Allah Almighty for his countless blessings he has bestowed on me generally and in accomplishing this thesis especially.

I would like to express my deepest gratitude to my supervisor Prof. Frank Coolen. To work with him is a real pleasure to me. He is always patient and encouraging in times of new ideas and difficulties. His ability to select and to approach compelling research problems, his high scientific standards, and his hard work set an example. I admire his ability to balance research interests and personal pursuits. Above all, he made me feel a friend, which I appreciate from my heart. It is very hard to find the words to express my appreciation for him. Actually, without his help and guidance this work would not have been possible.

I would like also to express my immense gratitude to my second supervisor, Dr. Iain MacPhee. To my great sadness, Iain MacPhee passed away in January 2012 following a long standing battle with cancer. He was an excellent supervisor. He patiently taught me so much that has enriched my knowledge, and I wish I could tell him how much I appreciate that.

My final thanks go to everyone who has assisted me, stood by me or contributed to my educational progress in any way.

# Contents

<b>Abstract</b>	<b>iii</b>
<b>Declaration</b>	<b>iv</b>
<b>Acknowledgements</b>	<b>v</b>
<b>1 Introduction</b>	<b>1</b>
1.1 Imprecise probability . . . . .	2
1.2 Nonparametric predictive inference . . . . .	3
1.3 $k$ -out-of- $m$ systems . . . . .	4
1.4 Outline of thesis . . . . .	8
<b>2 Series of independent voting subsystems</b>	<b>10</b>
2.1 Introduction . . . . .	10
2.2 NPI for Bernoulli quantities . . . . .	11
2.3 NPI for a $k$ -out-of- $m$ system . . . . .	14
2.3.1 Examples of $k$ -out-of- $m$ systems . . . . .	16
2.4 Series of independent $k^i$ -out-of- $m^i$ subsystems . . . . .	18
2.5 Redundancy allocation . . . . .	22
2.5.1 Redundancy allocation algorithm . . . . .	22
2.5.2 Optimality of redundancy allocation algorithm . . . . .	24
2.6 Redundancy allocation with component costs . . . . .	29
2.7 Concluding remarks . . . . .	32
<b>3 Subsystems consisting of one type of component</b>	<b>34</b>
3.1 Introduction . . . . .	34

---

3.2	Series of subsystems consisting of single-type components . . . . .	35
3.2.1	Two subsystems . . . . .	35
3.2.2	$L \geq 2$ subsystems . . . . .	37
3.3	Examples . . . . .	39
3.4	Concluding remarks . . . . .	47
<b>4</b>	<b>Voting systems with multiple component types</b>	<b>48</b>
4.1	Introduction . . . . .	48
4.2	Multiple component types . . . . .	50
4.2.1	System description . . . . .	50
4.2.2	NPI lower and upper probabilities for functioning of the system	51
4.2.3	Derivation of the NPI lower and upper probabilities for functioning of the system . . . . .	53
4.2.4	Redundancy allocation . . . . .	55
4.3	Examples . . . . .	57
4.4	Concluding remarks . . . . .	64
<b>5</b>	<b>Subsystems with multiple component types</b>	<b>66</b>
5.1	Introduction . . . . .	66
5.2	Subsystems with multiple component types . . . . .	67
5.3	2 subsystems with 2 component types . . . . .	69
5.4	$L$ subsystems with $T$ component types . . . . .	70
5.5	Examples . . . . .	77
5.6	Concluding remarks . . . . .	81
<b>6</b>	<b>Conclusions</b>	<b>83</b>
	<b>Appendix</b>	<b>89</b>
<b>A</b>	<b>Brief guide to notation</b>	<b>89</b>
	<b>Bibliography</b>	<b>90</b>



# Chapter 1

## Introduction

In classical reliability theory most of the methods and models use precise probabilities to quantify uncertainty, assuming completeness of the probabilistic information about the system and component reliability behaviour. Walley [57] discussed many reasons why precise probability is too restrictive for practical uncertainty quantification. In reliability, the most important ones include limited knowledge and information about random quantities of interest, and possibly information from several sources which might appear to be conflicting if restricted to precise probabilities.

During the past few decades, several alternative methods for uncertainty quantification have been proposed, some also for reliability. For example, fuzzy reliability theory [11] and possibility theory [32] provided solutions to problems that could not be solved satisfactorily with precise probabilities. The theory of imprecise probabilities [57] and the theory of interval probability [59] have been used as a general and promising tool for reliability analysis. Coolen [13] provided an insight into imprecise reliability, discussing a variety of issues and reviewing suggested applications of imprecise probabilities in reliability, see [54] for a detailed overview of imprecise reliability and many references.

In this thesis a statistical approach which uses imprecise probability is presented for system reliability. This approach is called Nonparametric Predictive Inference (NPI). It provides a new method for statistical inference on system reliability on the basis of limited information resulting from component testing.

Section 1.1 provides a brief introduction to imprecise probability, which is an umbrella term encompassing all qualitative and quantitative ways of measuring uncertainty without single-valued probabilities. In Section 1.2 we review briefly the main idea of NPI. The class of  $k$ -out-of- $m$  systems and a brief overview of some recent contributions that focus on reliability of this class of systems is presented in Section 1.3. The outline of this thesis is given in Section 1.4.

## 1.1 Imprecise probability

The idea to use interval-valued probabilities dates back at least to the middle of the nineteenth century [10]. In recent years this has particularly been a growing area of research. Researchers with widely varying backgrounds are currently contributing to theory, and indeed applications, of imprecise probability, including mathematicians, statisticians, computer scientists, and researchers working on artificial intelligence, medicine, and a variety of engineering areas. Such researchers are brought together via the Society for Imprecise Probability Theory and Applications (SIPTA, <http://www.sipta.org>), which also organizes biennial conferences.

In classical probability theory, a single probability  $P(A) \in [0, 1]$  is used to quantify uncertainty about an event  $A$ . Lower and upper probabilities generalize the standard theory of ('single-valued' or 'precise') probability and provide a powerful method for uncertainty quantification [54]. The main idea is that, for an event  $A$ , lower probability  $\underline{P}(A) \in [0, 1]$  and upper probability  $\overline{P}(A) \in [0, 1]$  with  $0 \leq \underline{P}(A) \leq \overline{P}(A) \leq 1$  are specified, such that these lower and upper probabilities define a so-called 'structure'  $\mathcal{M}$ , which is a set of precise probability distributions corresponding to the lower and upper probabilities in the sense that for each probability distribution  $P(\cdot) \in \mathcal{M}$ ,  $\underline{P}(A) \leq P(A) \leq \overline{P}(A)$  and  $\underline{P}(A) = \inf_{P(\cdot) \in \mathcal{M}} P(A)$  and  $\overline{P}(A) = \sup_{P(\cdot) \in \mathcal{M}} P(A)$  [8]. The classical situation of precise probability occurs if  $\underline{P}(A) = \overline{P}(A)$ , whereas  $\underline{P}(A) = 0$  and  $\overline{P}(A) = 1$  represents complete lack of knowledge about  $A$ . These lower and upper probabilities are naturally linked by the conjugacy property  $\overline{P}(A) = 1 - \underline{P}(A^c)$  [8]. This generalization allows indeterminacy about  $A$  to be taken into account, and lower and upper probabilities can also be

interpreted in several ways. One can consider them as bounds for a precise probability, related to relative frequency of the event  $A$ , reflecting the limited information one has about  $A$ . Generally,  $\underline{P}(A)$  reflects the information and beliefs in favour of event  $A$ , while  $\overline{P}(A)$  reflects such information and beliefs against  $A$ , so in favour of  $A^c$ .

Coolen [12] presented lower and upper predictive probabilities for Bernoulli random quantities. These lower and upper probabilities are part of a wider statistical methodology called ‘Nonparametric Predictive Inference’ (NPI), which is a frequentist statistical approach with strong consistency properties in the theory of imprecise probability [8].

## 1.2 Nonparametric predictive inference

Nonparametric predictive inference (NPI) is a statistical method to learn from data in the absence of prior knowledge and using only few modelling assumptions. It provides a solution to some explicit goals for objective (Bayesian) inference, for example the empirical and logical norms as formulated by Williamson [60]. These goals cannot be obtained when using precise probabilities, but are achieved by NPI after slight reformulation to allow the use of lower and upper probabilities [14]. It is also exactly calibrated [39], which is a strong consistency property in frequentist statistics, and it never leads to results that are in conflict with inferences based on empirical probabilities.

NPI is based on Hill’s assumption  $A_{(n)}$  [35], which gives direct probabilities [31] for a future observable random quantity, based on observed values of  $n$  related random quantities. Suppose that  $X_1, \dots, X_n, X_{n+1}$  are continuous and exchangeable random quantities. So, for one such a random quantity, its rank among all these random quantities is uniformly distributed over the values 1 to  $n + 1$  (assuming no ties for simplicity). Let the ordered observed values of  $X_1, \dots, X_n$  be denoted by  $x_{(1)} < x_{(2)} < \dots < x_{(n)} < 1$ , and let  $x_{(0)} = -\infty$  and  $x_{(n+1)} = \infty$  for ease of notation. For a future observation  $X_{n+1}$ , based on  $n$  observations,  $A_{(n)}$  is

$$P(X_{n+1} \in (x_{j-1}, x_j)) = \frac{1}{n+1} \quad j = 1, 2, \dots, n+1$$

$A_{(n)}$  does not assume anything else, and can be considered to be a post-data assumption related to exchangeability [30]. For a detailed discussion of  $A_{(n)}$  we refer to Hill [36]. Inferences based on  $A_{(n)}$  are predictive and nonparametric, and are suitable if there is hardly any knowledge about the random quantity of interest, other than the first  $n$  observations, or if one does not want to use such information, for example to study effects of additional assumptions underlying other statistical methods. Nevertheless,  $A_{(n)}$  has not received much attention in the statistical literature. A logical reason is that it only assigns equal probabilities for the next observation to belong to each of the  $n + 1$  intervals created by the previous  $n$  observations, so very few inferences can be based on this without requiring additional assumptions. However, it provides bounds for probabilities for all events of interest involving  $X_{n+1}$ . These bounds follow from De Finetti's fundamental theorem of probability [30] and are the sharpest bounds for all events, corresponding to the probabilities defined by the assumption  $A_{(n)}$ . Consequently, these are lower and upper probabilities in the theory of imprecise probability.

NPI is a framework of statistical theory and methods that use these  $A_{(n)}$ -based lower and upper probabilities. It has been presented for Bernoulli data [12], real-valued data [8], data including right-censored observations [25] and multinomial data [21, 22]. NPI has a wide range of applications in statistics, operational research and reliability [17]. For example, applications of NPI to basic problems in reliability include reliability demonstration for failure-free periods [23], (opportunity-based) age replacement [26, 27], comparison of success-failure data [28], probabilistic safety assessment in case of zero failures [15], and prediction of not yet observed failure modes [16]. In this thesis, we are interested in NPI for system reliability, in particular NPI for *k*-out-of-*m* systems, and for systems that consist of multiple  $k^i$ -out-of- $m^i$  subsystems in series configuration [18, 19, 42].

### 1.3 *k*-out-of-*m* systems

The class of *k*-out-of-*m* systems, also called 'voting systems', was introduced by Birnbaum [9]. These are systems that consist of  $m$  exchangeable components (often

the confusing term identical components is used), such that the system functions if and only if at least  $k$  of its components function. Since the value of  $m$  is usually larger than the value of  $k$ , redundancy is generally built into a  $k$ -out-of- $m$  system. Both parallel and series systems are special cases of the  $k$ -out-of- $m$  system. A series system is equivalent to an  $m$ -out-of- $m$  system while a parallel system is equivalent to an 1-out-of- $m$  system.

Throughout this thesis, we use the term ‘exchangeable components’ to indicate the scenario required for application of  $A_{(n)}$  as described in Sections 1.2 and 2.2. Effectively, exchangeable components are ‘similar’ with regard to our knowledge about their functioning. In practice, this may typically apply to components which are manufactured in the same process and which have similar roles in the system which is being considered. Information about the quality of components is assumed to come from testing of further components which are exchangeable with those in the system. Therefore, this would typically require that tests take place under similar circumstances as will apply to the functioning of the components in the system.

Applications of  $k$ -out-of- $m$  systems can e.g. be found in the areas of target detection, communication, safety monitoring systems, and, particularly, voting systems. The  $k$ -out-of- $m$  systems are a very common type in fault-tolerant systems with redundancy. They have many applications in both industrial and military systems. Fault-tolerant systems include the multi-display system in a cockpit, the multi-engine system in an airplane, and the multi-pump system in a hydraulic control system [52]. For example, a car with a  $V8$  engine may be driven if only four cylinders are firing. But, if less than four cylinders fire, then the car cannot be driven. Thus, the functioning of the engine can be considered as a 4-out-of-8 system. The system is tolerant of failures of up to four cylinders for minimal functioning of the engine [38]. In a data processing system with five video displays, a minimum of three displays operable may be sufficient for full data display. In this case the display system functions as a 3-out-of-5 system. In a communications system with three transmitters, the average message load may be such that at least two transmitters must be operational at all times, or else critical messages may be lost. Thus, the transmission system behaves as a 2-out-of-3 system. Systems with spares may also

be represented by a  $k$ -out-of- $m$  system model. A car with four tires, for example, usually has one additional spare tire. Thus, the vehicle can be driven as long as at least 4-out-of-5 tires are in good condition [38].

A traditional problem considered in reliability theory is assessment of system reliability [7], where voting systems have received particular attention. Many recent contributions to the literature focus on reliability of the class of  $k$ -out-of- $m$  systems, albeit from a classical perspective using precise probabilities to quantify uncertainty. For example, Torres-Echeverria *et al.* [53] address modelling of probability of dangerous failure on demand and spurious trip rate of safety instrumented systems that include  $k$ -out-of- $m$  voting redundancies in their architecture. Senz-de-Cabezn *et al.* [49] presented computational algebraic algorithms for the reliability of generalized  $k$ -out-of- $m$  and related systems. They analysed and computed identities and bounds for the reliability of coherent systems using the techniques of commutative algebra. They applied the techniques to the analysis of some of the most relevant  $k$ -out-of- $m$  systems. They concluded that the efficiency of their approach in obtaining exact identities, bounds and asymptotic formulas shows good performance when compared with others results from the literature.

Moghaddass *et al.* [45] consider a general repairable  $k$ -out-of- $m$  system with non-identical components that can have different repair priorities. They address the problem of efficient evaluation of the system's availability in a way that steady state solutions can be obtained systematically with reasonable computation time. Vaurio [56] considers the unavailability of redundant standby systems with  $k$ -out-of- $m$  logic. Such systems are subject to latent failures that are detected by periodic tests and repaired immediately after discovery. He considers many potential failure and error modes in the formalism, evaluates both consecutive and staggered testing schemes and suggests methods for including common cause failures in the analyses. Levitin [40] proposes a model that generalizes linear consecutive  $k$ -out-of- $r$ -from- $m$  systems to linear  $n$ -gap-consecutive  $k$ -out-of- $r$ -from- $m : F$  systems. In this model the system consists of  $m$  linearly ordered statistically independent identical elements and fails if the gap between any pair of groups of  $r$  consecutive elements containing at least  $k$  failed elements is less than  $n$  elements.

Erylmaz [33] studied circular consecutive  $k$ -out-of- $m$  systems consisting of exchangeable components. He derived explicit expressions for both unconditional and conditional survival functions for  $2k + 1 \geq m$ , while signature-based mixture representations for general  $k$  are obtained. Salehi *et al.* [50] considered linear and circular consecutive  $k$ -out-of- $m$  systems. It is assumed that lifetimes of components of the systems are independent but their probability distributions are non-identical. The reliability properties of the residual lifetimes of such systems under the condition that at least  $m - r + 1$ , with  $r \leq m$ , components of the system are operating was studied. The probability that a specific number of components of the above-mentioned system operate at time  $t$ ,  $t > 0$ , under the condition that the system is alive at time  $t$  was also investigated. Gurler and Capar [34] established an algorithm for the computation of the mean residual lifetime of an  $(m - k + 1)$ -out-of- $m$  system in the case of independent but not necessarily identically distributed lifetimes of the components. They gave an application for the exponentiated Weibull distribution to study the effect of various parameters on the mean residual lifetime of the system. The relationship between the mean residual lifetime for the system and that of its components was also investigated. Ruiz-Castro and Li [48] presented an algorithm for a general discrete voting system subject to several types of failure with an indefinite number of repairpersons. The model is built and the stationary distribution, for the general case, is derived using matrix-analytic methods. They computed performance measures of interest for the transient and the stationary regime, including availability, reliability and the conditional probability of failure for the different types of failures and for the system.

These recent papers are evidence of the continuing importance of development of methodology to quantify system reliability. The NPI approach presented in this thesis provides the important opportunity to reflect, by the use of lower and upper probabilities, the fact that information from tests is often quite limited.

## 1.4 Outline of thesis

In this thesis, we present important extensions for the NPI approach to system reliability. Coolen-Schrijner *et al.* [29] considered NPI for system reliability, and in particular for series systems with subsystem  $i$  a  $k^i$ -out-of- $m^i$  system. They presented an attractive algorithm for optimal redundancy allocation, with additional components added to subsystems one at a time. However, they only proved this result for test data with no failed components. We start with generalising the algorithm for redundancy allocation presented by Coolen-Schrijner *et al.* [29] to general test results, a situation in which redundancy plays an even more important role than when testing revealed no failures at all. We also illustrate redundancy allocation for the same system in case the costs of additional components differ per subsystem. Then NPI is presented for system reliability in a similar setting, but with all subsystems consisting of the same single type of component. As a further step in the development of NPI for system reliability, where more general system structures can be considered, nonparametric predictive inference for reliability of voting systems with multiple component types is presented. We start with a single voting system with multiple component types, then we extend to a series configuration of voting subsystems with multiple component types. Throughout this thesis we assume information from tests of  $n_t$  components of type  $t$ . All computations were performed using R. Some parts of this thesis have been presented at conferences and related papers have been published in academic journals or are in submission [1–6, 18, 19, 42].

Chapter 2 begins with a brief overview of NPI for Bernoulli data, using a path counting technique to compute upper and lower probabilities. We present the main results on NPI for  $k$ -out-of- $m$  systems, and these results are illustrated and discussed via examples. We provide a detailed presentation of optimal redundancy allocation following general component test results and the proofs of the main results. We present another extension for the NPI approach to system reliability, namely inclusion of different costs per component of the different types. Part of this chapter was presented at the 18th Advances in Risk and Reliability Technology Symposium (Loughborough, UK, 2009) [1].



In Chapter 3, we consider NPI for system reliability in a similar setting, but with all subsystems consisting of the same single type of component. Such components are exchangeable with regard to the information about them contained in test results but they play different roles in the system if they are in different subsystems. NPI lower and upper probabilities for a series of two  $k^i$ -out-of- $m^i$  subsystems consisting of single-type components are derived. These results are generalized to systems with  $L \geq 2$   $k^i$ -out-of- $m^i$  subsystems in a series configuration. This chapter was presented (by Frank Coolen) at a symposium in remembrance of Professor Jan M. van Noortwijk (Delft, the Netherlands, 2009) [18].

In Chapter 4, we consider more general system structures. Whilst restricting attention to a single voting system, this can now consist of multiple types of components. They are assumed to all play the same role within the system, but with regard to their reliability components of different types are assumed to be independent. This chapter was presented at the International Conference on Accelerated Life Testing, Reliability-based Analysis and Design: ALT2010 (Clermont-Ferrand, France, 2010) [2].

In Chapter 5, we generalize the results introduced in Chapters 2, 3 and 4 by considering systems in series structure where each subsystem is a voting system with multiple types of components and with components of the same type appearing in different subsystems. A part of Chapter 5 was presented at the 19th Advances in Risk and Reliability Technology Symposium (Stratford-upon-Avon, UK, 2011) [3], and a comprehensive overview of Chapter 5 and the main parts of this thesis was presented at the European Safety & Reliability Conference - ESREL 2011 (Troyes, France, 2011) [4].

In Chapter 6, we discuss opportunities to extend the research presented in this thesis, which is also discussed in the final sections of each of Chapters 2 to 5.

Although the most general results in Chapter 5 contain the results of Chapters 2, 3 and 4 as special cases, the presentation in this thesis reflects the progress of the research project over time and in every step a substantial problem is solved, hence this order of detailed presentation provides much insight into the complexities involved.

# Chapter 2

## Series of independent voting subsystems

### 2.1 Introduction

Coolen-Schrijner *et al.* [29] considered NPI for system reliability, and in particular for series systems with subsystem  $i$  a  $k^i$ -out-of- $m^i$  system. Such systems are common in practice, and can offer the important advantage of building in redundancy by increasing some  $m^i$  to increase the system reliability. Coolen-Schrijner *et al.* [29] applied NPI for Bernoulli data [12] to such systems, with inferences on each subsystem  $i$  based on information from tests on  $n^i$  components, with the components tested assumed to be exchangeable with the corresponding components to be used in that subsystem. Coolen-Schrijner *et al.* [29] presented an attractive algorithm for optimal redundancy allocation, with additional components added to subsystems one at a time, which in their setting was proven to be optimal. Hence, NPI for system reliability provides a very tractable model, which greatly simplifies optimization problems involved with redundancy allocation. However, they only proved this result for tests in which no components failed. In this chapter, this result is generalized for redundancy allocation following tests in which any number of components can have failed, a situation in which redundancy possibly plays an even more important role than when testing revealed no failures at all.

Section 2.2 presents a brief overview of NPI, and particularly of NPI for Bernoulli data using a path counting technique to compute upper and lower probabilities. Section 2.3 presents the main results on NPI for  $k$ -out-of- $m$  systems [29], and these results are illustrated and discussed via examples. Section 2.4 extends this approach to systems which are series of independent subsystems, with each subsystem a  $k^i$ -out-of- $m^i$  system with exchangeable components. Section 2.5 provides a detailed presentation of optimal redundancy allocation following general component test results and the proof of optimality. Section 2.6 presents another extension for the NPI approach to system reliability, namely the optimization of system reliability under cost considerations. Section 2.7 contains some concluding remarks.

## 2.2 NPI for Bernoulli quantities

In this section, NPI for Bernoulli random quantities [12] is summarized, together with the key results for NPI for system reliability by Coolen-Schrijner *et al.* [29]. Suppose that there is a sequence of  $n + m$  exchangeable Bernoulli trials, each with ‘success’ and ‘failure’ as possible outcomes, and data consisting of  $s$  successes in  $n$  trials. Let  $Y_1^n$  denote the random number of successes in trials 1 to  $n$ , then a sufficient representation of the data for the inferences considered is  $Y_1^n = s$ , due to the assumed exchangeability of all trials. Let  $Y_{n+1}^{n+m}$  denote the random number of successes in trials  $n + 1$  to  $n + m$ . Let  $R_t = \{r_1, \dots, r_t\}$ , with  $1 \leq t \leq m + 1$  and  $0 \leq r_1 < r_2 < \dots < r_t \leq m$ , and, for ease of notation, define  $\binom{s+r_0}{s} = 0$ . Then the NPI upper probability for the event  $Y_{n+1}^{n+m} \in R_t$ , given data  $Y_1^n = s$ , for  $s \in \{0, \dots, n\}$ , is

$$\begin{aligned} \overline{P}(Y_{n+1}^{n+m} \in R_t | Y_1^n = s) = \\ \binom{n+m}{n}^{-1} \times \sum_{j=1}^t \left[ \binom{s+r_j}{s} - \binom{s+r_{j-1}}{s} \right] \binom{n-s+m-r_j}{n-s} \end{aligned}$$

The corresponding NPI lower probability can be derived via the conjugacy property

$$\underline{P}(Y_{n+1}^{n+m} \in R_t | Y_1^n = s) = 1 - \overline{P}(Y_{n+1}^{n+m} \in R_t^c | Y_1^n = s)$$

where  $R_t^c = \{0, 1, \dots, m\} \setminus R_t$ .

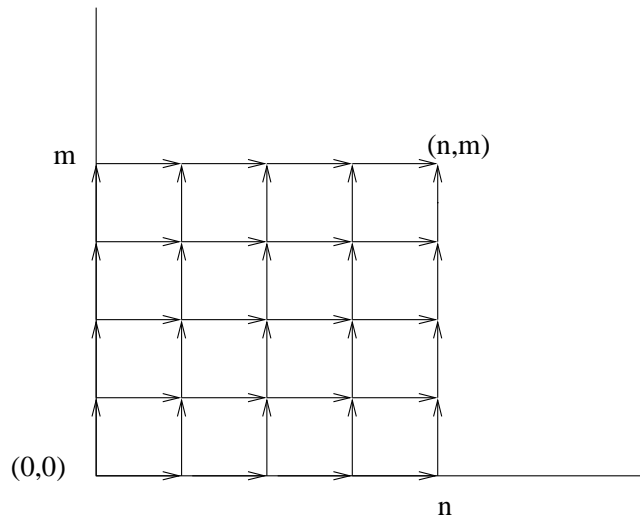
Figure 2.1: All possible paths from  $(0,0)$  to  $(n,m)$ 

Coolen [12] derived these NPI lower and upper probabilities through direct counting arguments. The method uses the appropriate  $A_{(n)}$  assumptions [35] for inference on  $m$  future random quantities given  $n$  observations, and a latent variable representation with Bernoulli quantities represented by observations on the real line, with a threshold such that successes are to one side and failures to the other side of the threshold. Under these assumptions, the  $\binom{n+m}{n}$  different orderings of these observations, when not distinguishing between the  $n$  observed values nor between the  $m$  future observations, are all equally likely. For each such an ordering, the success-failure threshold can be in any of the  $n+m+1$  intervals of the partition of the real line created by the  $n+m$  values of the latent variables, leading to  $n+m+1$  possible combinations  $(s,r)$ , with  $s$  successes in the  $n$  tests and  $r$  successes in the  $m$  future observations.

For such an ordering, these possible  $(s,r)$  can be represented as a path on the rectangular lattice from  $(0,0)$  to  $(n,m)$  with steps going either one to the right or one upwards (see Figure 2.1). The  $\binom{n+m}{n}$  different orderings, which are all equally likely, correspond to the  $\binom{n+m}{n}$  different right-upwards paths from  $(0,0)$  to  $(n,m)$ , and hence the above NPI lower and upper probabilities can also be derived by counting paths. To derive the NPI lower probability  $\underline{P}(Y_{n+1}^{n+m} \in R_t | Y_1^n = s)$ , one counts all such paths which for given  $s$  must go only through points  $(s,r)$  with

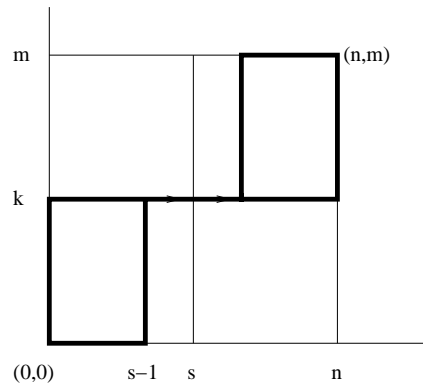

Figure 2.2: all paths from  $(0,0)$  to  $(n,m)$  that pass through  $(s-1,k)$  and  $(s+1,k)$

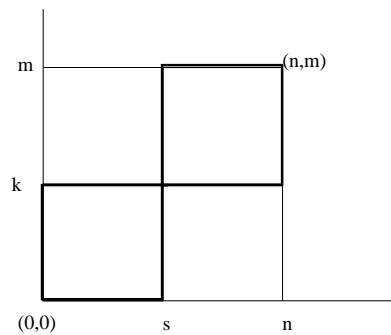

Figure 2.3: All paths from  $(0,0)$  to  $(n,m)$  via  $(s,k)$

$r \in R_t$ , so they do not go through  $(s,l)$  for any  $l \in R_t^c$ . The corresponding NPI upper probability  $\bar{P}(Y_{n+1}^{n+m} \in R_t | Y_1^n = s)$  is derived by counting all such paths that go through at least one  $(s,r)$  with  $r \in R_t$ . For example, the NPI lower probability for the event  $(Y_{n+1}^{n+m} = k | Y_1^n = s)$  can be derived by counting the paths from  $(0,0)$  to  $(n,m)$  that pass through the two points  $(s-1,k)$  and  $(s+1,k)$  respectively (see Figure 2.2). The number of these paths is  $\binom{s-1+k}{s-1} \binom{n-s-1+m-k}{m-k}$ , hence

$$\underline{P}(Y_{n+1}^{n+m} = k | Y_1^n = s) = \binom{n+m}{n}^{-1} \left[ \binom{s-1+k}{s-1} \binom{n-s-1+m-k}{m-k} \right]$$

The corresponding NPI upper probability can be derived by counting all paths from  $(0,0)$  to  $(n,m)$  via  $(s,k)$  (see Figure 2.3). The number of these paths is  $\binom{s+k}{s} \binom{n-s+m-k}{n-s}$ , hence

$$\bar{P}(Y_{n+1}^{n+m} = k | Y_1^n = s) = \binom{n+m}{n}^{-1} \left[ \binom{s+k}{s} \binom{n-s+m-k}{n-s} \right]$$

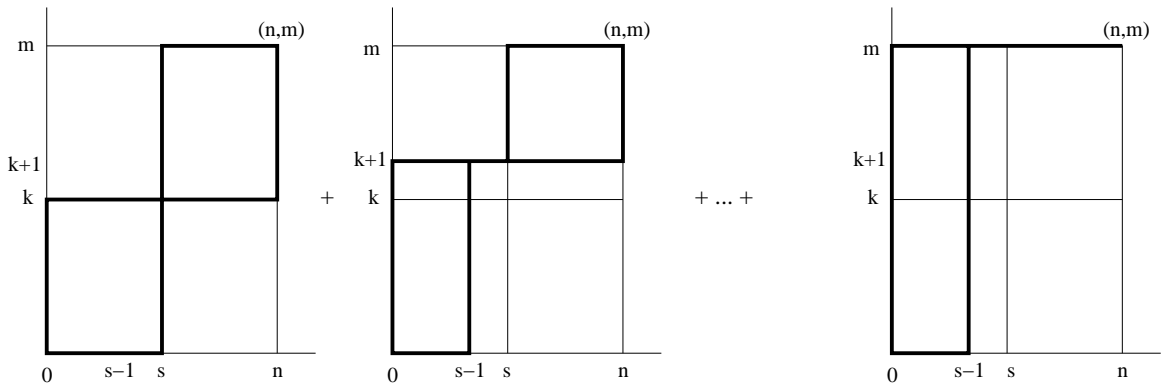

Figure 2.4: All paths which are counted in the upper probability (2.1)

In the next section, these results of NPI for Bernoulli data, are used to compute upper and lower probabilities for successful functioning of  $k$ -out-of- $m$  systems.

### 2.3 NPI for a $k$ -out-of- $m$ system

When considering a  $k$ -out-of- $m$  system, the event  $Y_{n+1}^{n+m} \geq k$  is of interest as this corresponds to successful functioning of a  $k$ -out-of- $m$  system, following  $n$  tests of components that are exchangeable with the  $m$  components in the system considered. Given data consisting of  $s$  successes from  $n$  components tested, the NPI lower and upper probabilities for the event that the  $k$ -out-of- $m$  system functions successfully are also denoted by  $\underline{P}(S(m : k) | (n, s))$  and  $\overline{P}(S(m : k) | (n, s))$ , respectively. From the NPI upper probability for  $Y_{n+1}^{n+m} \in R_t$  given above,  $\overline{P}(S(m : k) | (n, s))$  follows easily. For  $k \in \{1, 2, \dots, m\}$  and  $0 < s < n$ ,

$$\overline{P}(S(m : k) | (n, s)) = \overline{P}(Y_{n+1}^{n+m} \geq k | Y_1^n = s) = \binom{n+m}{n}^{-1} \times \left[ \binom{s+k}{s} \binom{n-s+m-k}{n-s} + \sum_{l=k+1}^m \binom{s+l-1}{s-1} \binom{n-s+m-l}{n-s} \right] \quad (2.1)$$

This NPI upper probability can also be derived by counting all such paths that go through at least one point  $(s, r)$  with  $r \geq k$ . To avoid that no path is counted more than once, the number of these paths can be computed by counting all paths from  $(0,0)$  to  $(n, m)$  via  $(s, k)$ , in addition to paths from  $(0,0)$  to  $(n, m)$  via at least one of  $(s-1, k+1), (s-1, k+2), (s-1, k+3), \dots, (s-1, m)$  (see Figure 2.4). The

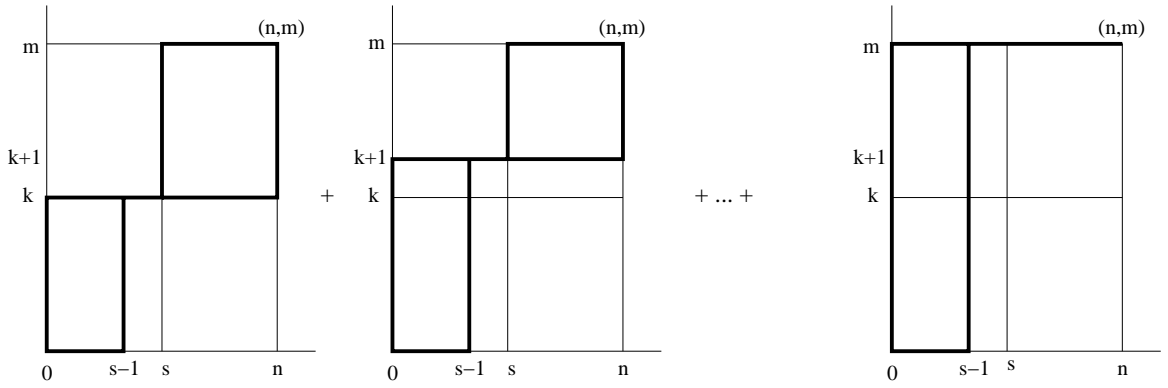

Figure 2.5: All paths which are counted in the lower probability (2.2)

corresponding NPI lower probability can be derived via the conjugacy property or by counting all paths which go through  $(s, r)$  for  $r \geq k$  but not through any point  $(s, r)$  with  $r$  less than  $k$ . The number of these paths is equal to the number of paths from  $(0,0)$  to  $(n, m)$  via at least one of  $(s-1, k), (s-1, k+1), (s-1, k+2), \dots, (s-1, m)$  (see Figure 2.5).

$$\begin{aligned} \underline{P}(S(m : k) | (n, s)) &= \underline{P}(Y_{n+1}^{n+m} \geq k | Y_1^n = s) = 1 - \overline{P}(Y_{n+1}^{n+m} \leq k-1 | Y_1^n = s) \\ &= 1 - \binom{n+m}{n}^{-1} \left[ \sum_{l=0}^{k-1} \binom{s+l-1}{s-1} \binom{n-s+m-l}{n-s} \right] \end{aligned} \quad (2.2)$$

For  $m = 1$ , so considering a system consisting of just a single component, the NPI upper and lower probabilities for the event that the system functions successfully are

$$\begin{aligned} \overline{P}(S(1 : 1) | (n, s)) &= \overline{P}(Y_{n+1}^{n+1} = 1 | Y_1^n = s) = \frac{s+1}{n+1} \\ \underline{P}(S(1 : 1) | (n, s)) &= \underline{P}(Y_{n+1}^{n+1} = 1 | Y_1^n = s) = \frac{s}{n+1} \end{aligned}$$

If the observed data are all successes, so  $s = n$ , or all failures, so  $s = 0$ , then the NPI upper probabilities are, for all  $k \in \{1, \dots, m\}$ ,

$$\begin{aligned} \overline{P}(S(m : k) | (n, n)) &= \overline{P}(Y_{n+1}^{n+m} \geq k | Y_1^n = n) = 1 \\ \overline{P}(S(m : k) | (n, 0)) &= \overline{P}(Y_{n+1}^{n+m} \geq k | Y_1^n = 0) = \binom{n+m-k}{n} \binom{n+m}{n}^{-1} \end{aligned}$$

and the NPI lower probabilities are, for all  $k \in \{1, \dots, m\}$ ,

$$\begin{aligned} \underline{P}(S(m : k) | (n, n)) &= \underline{P}(Y_{n+1}^{n+m} \geq k | Y_1^n = n) = 1 - \binom{n+k-1}{n} \binom{n+m}{n}^{-1} \\ \underline{P}(S(m : k) | (n, 0)) &= \underline{P}(Y_{n+1}^{n+m} \geq k | Y_1^n = 0) = 0 \end{aligned}$$

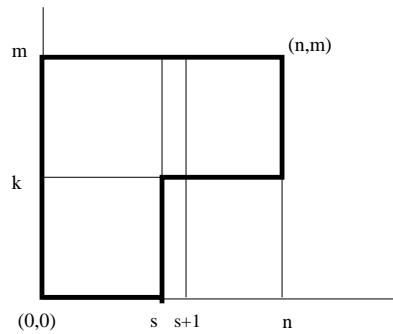

Figure 2.6: All paths which are counted in (2.3)

One of the results that actually holds generally for the NPI lower and upper probabilities for all  $k$ -out-of- $m$  systems as considered in this thesis is

$$\overline{P}(S(m : k) | (n, s)) = \underline{P}(S(m : k) | (n, s + 1)) \quad (2.3)$$

A direct proof of (2.3) can be easily achieved by using a path counting technique. Figure 2.6 shows that the paths that go through at least one point  $(s, r)$  with  $r \geq k$  (which are counted in the NPI upper probability for successful system functioning given  $s$  successes in  $n$  tests) are exactly the same paths that go through  $(s + 1, r)$  for  $r \geq k$  but not through any point  $(s + 1, r)$  with  $r$  less than  $k$  (which are counted in the NPI lower probability for successful system functioning given  $s + 1$  successes).

### 2.3.1 Examples of $k$ -out-of- $m$ systems

In this subsection two examples are presented to illustrate NPI for reliability of  $k$ -out-of- $m$  systems, and some related issues are discussed.

#### Example 2.1

Consider a  $k$ -out-of-6 system. Table 2.1 provides the NPI lower and upper probabilities for all possible cases with  $n = 5$  components tested, of which  $s$  functioned successfully, and with  $k$  varying from 1 to 6. The values in Table 2.1 illustrate some of the general properties for all  $k$ -out-of- $m$  systems. The NPI upper probability for successful system functioning given  $s$  successes in  $n$  tests is equal to the NPI lower



	$k = 1$		$k = 2$		$k = 3$		$k = 4$		$k = 5$		$k = 6$	
	$\underline{P}$	$\overline{P}$	$\underline{P}$	$\overline{P}$	$\underline{P}$	$\overline{P}$	$\underline{P}$	$\overline{P}$	$\underline{P}$	$\overline{P}$	$\underline{P}$	$\overline{P}$
$s = 0$	0	0.545	0	0.273	0	0.121	0	0.045	0	0.013	0	0.002
$s = 1$	0.545	0.818	0.273	0.576	0.121	0.348	0.045	0.175	0.013	0.067	0.002	0.015
$s = 2$	0.818	0.939	0.576	0.803	0.348	0.608	0.175	0.392	0.067	0.197	0.015	0.061
$s = 3$	0.939	0.985	0.803	0.933	0.608	0.825	0.392	0.652	0.179	0.424	0.061	0.182
$s = 4$	0.985	0.998	0.933	0.987	0.825	0.955	0.652	0.878	0.424	0.727	0.182	0.455
$s = 5$	0.998	1	0.987	1	0.955	1	0.878	1	0.727	1	0.455	1

Table 2.1: NPI lower and upper probabilities for all possible cases with  $n = 5$ 

probability for successful system functioning given  $s + 1$  successes. The value 0 (1) of the NPI lower (upper) probability for the case  $s = 0$  ( $s = 5$ ) reflects that in this case there is no strong evidence that the components can actually function (fail). In order to get a reasonably large NPI lower probability for successful system functioning, it is not necessarily required that most tested components functioned well if  $k$  is small, which means that the system has much built-in redundancy, but for large values of  $k$  (nearly) all tested components must have been successful. Table 2.1 shows that the lower and upper probabilities are decreasing in  $k$  when keeping  $m$ ,  $n$  and  $s$  constant, and increasing in  $s$  when keeping  $m$ ,  $n$  and  $k$  constant. This is most obvious from the large differences between the values at the top left and bottom right of Table 2.1.

### Example 2.2

Consider a 10-out-of- $m$  system. Suppose that, to increase the system's reliability by increasing redundancy, extra components can be added to the system, keeping  $k = 10$  but increasing the value of  $m$ . Assuming zero-failure testing, the NPI lower probabilities for the event that this system functions successfully are presented in Table 2.2, for  $n = 5, 10, 15, 20, 25$ , and  $m$  varying from 10 to 15. Of course, the corresponding NPI upper probabilities are all equal to one as there are no failed components. Table 2.2 shows that the system's reliability as measured by NPI lower probability is increasing in  $m$ , keeping  $n$  and  $k$  constant, and increasing in  $n$ , keeping  $m$  and  $k$  constant.

	$m = 10$	11	12	13	14	15
$s = n = 5$	0.333	0.542	0.676	0.766	0.828	0.871
10	0.500	0.738	0.857	0.919	0.953	0.972
15	0.600	0.831	0.925	0.965	0.983	0.992
20	0.667	0.882	0.956	0.983	0.993	0.997
25	0.714	0.913	0.972	0.990	0.997	0.999

Table 2.2: NPI lower probabilities for the systems in Example 2.2

The NPI lower probabilities presented in Table 2.2 can be used in several ways. For example, consider the case  $m = 10$  with 5 zero-failure tests, leading to NPI lower probability 0.333 for successful system functioning. The table shows that increasing the redundancy to  $m = 11$ , keeping  $k = 10$ , would increase the NPI lower probability to 0.542, while increasing the number of zero-failure tests to 10 would increase the NPI lower probability to 0.5, so if these two actions were available at similar costs, increase of redundancy might be preferred to more tests. However, if 15 tests were possible at a cost similar to the cost of adding one component to the system, then this might be preferred, as the corresponding NPI lower probability would increase to 0.6 if all 15 tests were successes. Of course, we do not know if extra tested components would all function successfully.

Table 2.3 extends this example by presenting the minimum number of zero-failure tests required to achieve a chosen value for the NPI lower probability for successful system functioning, again for  $k = 10$  and  $m$  varying from 10 to 15. The requirement considered is  $\underline{P}(S(m : 10) | (n, n)) \geq p$  for different values of  $p$ .

The main conclusion from Table 2.3 is that the system's reliability, as measured by NPI lower probability, can be increased either by having more successful tests or by building in redundancy.

## 2.4 Series of independent $k^i$ -out-of- $m^i$ subsystems

Coolen-Schrijner *et al.* [29] used the results for a  $k$ -out-of- $m$  system straightforwardly to consider the reliability of systems that consist of a series configuration

	$m = 10$	11	12	13	14	15
$p = 0.75$	30	11	7	5	4	4
0.80	40	13	8	6	5	4
0.85	57	17	10	7	6	5
0.90	90	23	13	9	7	6
0.95	190	37	19	13	10	8
0.99	990	95	40	25	18	15

Table 2.3: Values of  $n$  required to achieve chosen values of  $p$ .

of  $L \geq 2$  independent subsystems, with subsystem  $i$  ( $i = 1, \dots, L$ ) a  $k^i$ -out-of- $m^i$  system consisting of exchangeable components. As before, it is assumed that, in relation to subsystem  $i$ ,  $n^i$  components that are exchangeable with those to be used in the subsystem have been tested, of which  $s^i$  functioned successfully. For the series system to function, all its subsystems must function, and due to the assumed independence of the subsystems (which implies independence of components in different subsystems), the NPI lower and upper probabilities for such a series system to function are

$$\underline{P}(S^{[L]}(m^1 : k^1, \dots, m^L : k^L) \mid (\underline{n}, \underline{s})) = \prod_{i=1}^L \underline{P}(S(m^i : k^i) \mid (n^i, s^i)) \quad (2.4)$$

and

$$\overline{P}(S^{[L]}(m^1 : k^1, \dots, m^L : k^L) \mid (\underline{n}, \underline{s})) = \prod_{i=1}^L \overline{P}(S(m^i : k^i) \mid (n^i, s^i)) \quad (2.5)$$

Coolen-Schrijner *et al.* [29] considered optimal redundancy allocation for such systems, that is how best to assign additional components to subsystems (hence to increase the number of components  $m^i$ ), for situations where the required number of components that must function for the subsystems remains the same ( $k^i$ ). However, they only considered such redundancy allocation after zero-failure testing (so  $s^i = n^i$  for all  $i = 1, \dots, L$ ), for which case they derived a powerful algorithm for optimal redundancy allocation, with the lower probability for system functioning used as the reliability measure. The NPI lower and upper probabilities for such a series system to function are illustrated and discussed in the following example.

$(m^1, m^2) =$	(4, 4)	(4, 5)	(5, 5)	(4, 6)	(4, 7)	(5, 6)	(6, 6)
$(s^1, s^2) = (1, 1)$	0.0000	0.0001	0.0002	0.0001	0.0002	0.0005	0.0009
(1, 2)	0.0001	0.0003	0.0010	0.0006	0.0009	0.0018	0.0037
(2, 1)	0.0001	0.0004	0.0010	0.0007	0.0012	0.0020	0.0037
(2, 2)	0.0006	0.0016	0.0045	0.0029	0.0043	0.0081	0.0147
(3, 3)	0.0051	0.0125	0.0307	0.0203	0.0274	0.0497	0.0804
(4, 3)	0.0119	0.0292	0.0611	0.0473	0.0639	0.0988	0.1418
(5, 3)	0.0238	0.0584	0.1009	0.0945	0.1278	0.1633	0.2062
(3, 4)	0.0119	0.0249	0.0611	0.0357	0.0440	0.0877	0.1418
(3, 5)	0.0238	0.0411	0.1009	0.0519	0.0586	0.1275	0.2062
(4, 4)	0.0278	0.0581	0.1214	0.0833	0.1028	0.1742	0.2500
(5, 4)	0.0556	0.1162	0.2006	0.1667	0.2055	0.2879	0.3636
(6, 4)	0.1000	0.2091	0.2851	0.3000	0.3699	0.4091	0.4545
(4, 5)	0.0556	0.0960	0.2006	0.1212	0.1368	0.2534	0.3636
(4, 6)	0.1000	0.1364	0.2851	0.1515	0.1585	0.3168	0.4545
(5, 5)	0.1111	0.1919	0.3315	0.2424	0.2735	0.4187	0.5289
(6, 5)	0.2000	0.3455	0.4711	0.4364	0.4923	0.5950	0.6612
(5, 6)	0.2000	0.2727	0.4711	0.3030	0.3170	0.5234	0.6612
(6, 6)	0.3600	0.4909	0.6694	0.5454	0.5706	0.7438	0.8264

Table 2.4: NPI lower probability for system functioning

**Example 2.3**

Consider a system which consists of two independent subsystems (so  $L = 2$ ) in a series configuration, where for each subsystem 4 exchangeable components must function to ensure that the subsystem functions, hence  $k^1 = k^2 = 4$ , and where 6 components exchangeable with those in subsystem 1 have been tested, and also 6 components exchangeable with those in subsystem 2 have been tested, so  $n^1 = n^2 = 6$ . Tables 2.4 and 2.5 present the NPI lower and upper probabilities, respectively, for functioning of this system, for varying numbers of test successes ( $s^1$  and  $s^2$ ) and different numbers of components ( $m^1$  and  $m^2$ ) in these  $k^i$ -out-of- $m^i$  subsystems.

Test results for which the NPI lower probability for system functioning is zero ( $s^1 = 0$  or  $s^2 = 0$ ) are deleted from Table 2.4, the case  $s^1 = s^2 = 6$  is deleted from

$(m^1, m^2) =$	(4, 4)	(4, 5)	(5, 5)	(4, 6)	(4, 7)	(5, 6)	(6, 6)
$(s^1, s^2) = (0, 0)$	0.0000	0.0001	0.0002	0.0001	0.0002	0.0005	0.0009
(1, 0)	0.0001	0.0004	0.0010	0.0007	0.0012	0.0020	0.0037
(2, 0)	0.0003	0.0011	0.0027	0.0022	0.0035	0.0053	0.0086
(0, 1)	0.0001	0.0003	0.0010	0.0006	0.0009	0.0018	0.0037
(0, 2)	0.0003	0.0008	0.0027	0.0014	0.0018	0.0043	0.0086
(1, 1)	0.0006	0.0016	0.0045	0.0029	0.0043	0.0081	0.0147
(1, 2)	0.0017	0.0042	0.0118	0.0068	0.0091	0.0190	0.0344
(2, 1)	0.0017	0.0048	0.0118	0.0087	0.0128	0.0213	0.0344
(2, 2)	0.0051	0.0125	0.0307	0.0203	0.0274	0.0497	0.0804
(3, 3)	0.0278	0.0581	0.1214	0.0833	0.1028	0.1742	0.2500
(4, 3)	0.0556	0.1162	0.2006	0.1667	0.2055	0.2879	0.3636
(5, 3)	0.1000	0.2091	0.2851	0.3000	0.3699	0.4091	0.4545
(3, 4)	0.0556	0.0960	0.2006	0.1212	0.1368	0.2534	0.3636
(3, 5)	0.1000	0.1364	0.2851	0.1515	0.1585	0.3168	0.4545
(4, 4)	0.1111	0.1919	0.3315	0.2424	0.2735	0.4187	0.5289
(5, 4)	0.2000	0.3455	0.4711	0.4364	0.4923	0.5950	0.6612
(6, 4)	0.3333	0.5758	0.5758	0.7273	0.8205	0.7273	0.7273
(4, 5)	0.2000	0.2727	0.4711	0.3030	0.3170	0.5234	0.6612
(4, 6)	0.3333	0.3333	0.5758	0.3333	0.3333	0.5757	0.7273
(5, 5)	0.3600	0.4909	0.6694	0.5454	0.5706	0.7438	0.8264
(6, 5)	0.6000	0.8182	0.8182	0.9091	0.9510	0.9091	0.9091
(5, 6)	0.6000	0.6000	0.8182	0.6000	0.6000	0.8182	0.9091

Table 2.5: NPI upper probability for system functioning

Table 2.5 as the corresponding NPI upper probability is one for all  $m^1$  and  $m^2$ .

These tables illustrate the manner in which system reliability, measured by these NPI lower and upper probabilities, increases with increasing numbers of test successes and with increasing system redundancy. They also illustrate that, as the property  $\bar{P}(S(m : k) | (n, s)) = \underline{P}(S(m : k) | (n, s + 1))$  still holds per subsystem, for the whole system  $\bar{P}(S^{[L]}(m^1 : k^1, \dots, m^L : k^L) | (\underline{n}, \underline{s})) = \underline{P}(S^{[L]}(m^1 : k^1, \dots, m^L : k^L) | (\underline{n}, \underline{s} + 1))$ , where the elements of  $\underline{s} + 1$  is obtained by adding one to each element of  $\underline{s}$ . For example, the NPI upper probabilities for  $(s^1, s^2)$  equal to (1,1), (2,2), (3,3), (3,4), (4,3) and (4,4) are equal to the corresponding NPI lower probabilities

for  $(s^1, s^2)$  equal to (2,2), (3,3), (4,4), (4,5), (5,4) and (5,5) respectively. Note that in situations where for a particular subsystem all performed tests are successes, the NPI upper probability for system functioning is in fact the NPI upper probability that the other subsystem functions. For example, in Table 2.5 for  $(s^1, s^2) = (6, 5)$ , the NPI upper probabilities for system functioning with  $(m^1, m^2)$  equal to (4, 6), (5, 6) and (6, 6) are identical and equal to the NPI upper probability that subsystem 2, a 4-out-of-6 subsystem, functions.

The next section introduces a generalization of the optimal redundancy allocation algorithm by Coolen-Schrijner *et al.* [29] to general test results. It is particularly logical to focus attention on the NPI lower probability in this generalization, as the lower probability can be considered to be a conservative inference.

## 2.5 Redundancy allocation

The systems considered in this section consist of series configurations of  $L$  independent  $k^i$ -out-of- $m^i$  subsystems, and information about reliability of components results from tests in which, for subsystem  $i$ ,  $n^i$  components that are exchangeable with those in subsystem  $i$  have been tested, of which  $s^i$  functioned successfully. From now on, it is assumed that  $s^i \geq 1$  for all  $i = 1, \dots, L$ , in order to avoid problems occurring due to the fact that the NPI lower probability for successful functioning of a  $k^i$ -out-of- $m^i$  system is equal to zero if  $s^i = 0$ , for all  $n^i, k^i, m^i$ . In practice, it is unlikely that one would wish to proceed with components of which none functioned successfully in testing, so this assumption seems not to limit the practical applicability of the method proposed here in a significant manner.

### 2.5.1 Redundancy allocation algorithm

With reliability measured by the NPI lower probability for system functioning, optimal redundancy allocation of extra components can be achieved (as we prove in the next section), for any number of extra components, by sequential one-step optimal allocation. According to this technique, at each step an extra component is allocated to the subsystem for which the relative increase in reliability is maximal.

The algorithm to determine the optimal sequence of adding the extra components to subsystems is described below, where optimality is in the sense of maximum NPI lower probability.

The NPI lower probability for successful functioning of the whole system, following  $n^i$  tests of components exchangeable with those in subsystem  $i$  of which  $s^i$  functioned successfully, is  $\underline{P}(S^{[L]}(m^1 : k^1, \dots, m^L : k^L) \mid (\underline{n}, \underline{s}))$  as given by (2.4). Now consider the situation with  $j^i$  additional components added to subsystem  $i$ , for  $i = 1, \dots, L$ , with no further tests performed, then the NPI lower probability for successful functioning of the system becomes

$$\underline{P}(S^{[L]}(m^1 + j^1 : k^1, \dots, m^L + j^L : k^L) \mid (\underline{n}, \underline{s})) = \prod_{i=1}^L \underline{P}(S(m^i + j^i : k^i) \mid (n^i, s^i))$$

Optimal allocation of (any number of) additional components, to enhance the system reliability, can be achieved by adding the components in an optimal sequence according to the following algorithm (given in pseudo-code), in which, for  $i = 1, \dots, L$  and  $j^i \geq 0$ ,

$$\rho(i, j^i) = \frac{\underline{P}(S(m^i + j^i + 1 : k^i) \mid (n^i, s^i))}{\underline{P}(S(m^i + j^i : k^i) \mid (n^i, s^i))}$$

So  $\rho(i, j^i)$  is the factor by which the NPI lower probability for successful functioning of subsystem  $i$  increases when  $j^i + 1$  instead of  $j^i$  extra components are added to subsystem  $i$ , hence this represents the relative increase in reliability of both subsystem  $i$  and the whole system.

### Optimal allocation algorithm

1. Set  $j^i = 0$  and calculate  $\rho(i, j^i) = \rho(i, 0)$  for all  $i = 1, \dots, L$ ;
2. Determine  $i_m$  such that

$$\rho(i_m, j^{i_m}) = \max_{1 \leq i \leq L} \rho(i, j^i)$$

If this  $i_m$  is not a unique value, then, according to one-step-at-a-time optimisation, pick any one of these values (from the proof of optimality of this algorithm, as presented in Subsection 2.5.2, it follows that in case of multiple

maxima these can be taken in any order without affecting the optimal lower probability of system functioning at any stage);

3. Add an extra component to subsystem  $i_m$ : set  $j^{i_m} := j^{i_m} + 1$  and calculate  $\rho(i_m, j^{i_m})$ ;
4. Return to Step 2, using the same values  $\rho(i, j^i)$  as in the previous step for  $i \neq i_m$ , together with the new value  $\rho(i_m, j^{i_m})$  for subsystem  $i_m$ , as just calculated in Steps 2 and 3.

This algorithm can be stopped at any time, whatever stop-criterion is defined, and will always give optimal allocation of extra components. After stopping the algorithm, the vector  $\underline{j} = (j^1, \dots, j^L)$  gives the number of extra components added to each subsystem, and the NPI lower probability for successful functioning of the system after adding these extra components is equal to

$$\underline{P}(S^{[L]}(m^1 + j^1 : k^1, \dots, m^L + j^L : k^L) \mid (\underline{n}, \underline{s})) = \underline{P}(S^{[L]}(m^1 : k^1, \dots, m^L : k^L) \mid (\underline{n}, \underline{s})) \times \prod_{i=1}^L \prod_{l^i=0}^{j^i-1} \rho(i, l^i).$$

This enables easy calculation of the NPI lower probability following Step 3 of the above algorithm, as it just requires the previous value of this NPI lower probability to be multiplied by the  $\rho(i_m, j^{i_m})$  calculated at that step.

### 2.5.2 Optimality of redundancy allocation algorithm

It is claimed that the sequential one-step redundancy allocation algorithm presented in Section 2.5.1 provides overall optimality in the sense of maximum NPI lower probability for successful functioning of the system, no matter how many components can be added in total, or indeed how the number of extra components is determined. The proof of this optimality is given below with some change of notation for convenience.

Let  $\nu(n, m)$  denote the number of equally likely orderings of those variables for which the data  $Y_1^n = s$  must be followed by  $Y_{n+1}^{n+m} \geq k$  as explained in Section 2.3.1.



Let  $\lambda(n, m) = \underline{P}(m : k \mid n, s)$ , so

$$\lambda(n, m) = \binom{n+m}{n}^{-1} \nu(n, m) \quad (2.6)$$

For  $(n, m)$  such that  $n + m \geq s + k$  these  $\lambda(n, m)$  are

$$\lambda(n, m) = \begin{cases} \underline{P}(Y_{n+1}^{n+m} \geq k \mid Y_1^n = s), & n \geq s, m \geq k \\ 1, & 0 < n \leq s - 1, \\ 0, & 0 < m \leq k - 1 \end{cases} .$$

As  $\nu$  counts paths the following key equation holds

$$\nu(n, m + 1) = \nu(n, m) + \nu(n - 1, m + 1), \quad n + m \geq s + k$$

and by employing standard binomial identities

$$(n + m + 1)\lambda(n, m + 1) = (m + 1)\lambda(n, m) + n\lambda(n - 1, m + 1) . \quad (2.7)$$

When  $s = 1$  and  $k = 1$  the simple form  $\lambda(n, m) = m/(n + m)$  holds for  $n + m \geq 1$ .

It was shown by Coolen-Schrijner *et al.* [29] that  $\{\lambda(s, m)\}_m$  is increasing and log-concave, specifically  $\{\lambda(s, m) : m \geq k\}$  is increasing in  $m$ ,  $\{\lambda(s, m + 1)/\lambda(s, m) : m \geq k\}$  is decreasing in  $m$ . To prove that the redundancy allocation algorithm in the previous section is optimal, these results need to be generalized to the case of general  $n$ . The first step is establishing monotonicity for each  $n$ , working with diagonal sets of nodes, i.e. with  $n + m$  fixed.

**Lemma 2.1.** *For any  $n \geq s$ ,  $t \geq s + k$ ,*

1.  $\{\lambda(t - m, m) : k - 1 \leq m \leq t\}$  is increasing in  $m$ ;
2.  $\{\lambda(n, m) : m \geq k - 1\}$  is increasing in  $m$ .

*Proof.*

1. This is true for  $t = s + k$  as  $0 < s/(s + k) < 1$ . Suppose it is true for  $t \geq s + k$  and consider the sequence for  $t + 1$ . By (2.7)

$$\begin{aligned} \lambda(t - m, m + 1) &= \frac{m + 1}{t + 1} \lambda(t - m, m) + \frac{t - m}{t + 1} \lambda(t - m - 1, m + 1) \\ &> \lambda(t - m, m) && \text{(induc. hyp.)} \\ &> \frac{m}{t + 1} \lambda(t + 1 - m, m - 1) + \frac{t + 1 - m}{t + 1} \lambda(t - m, m) \\ &= \lambda(t + 1 - m, m) && \text{(by (2.7))} \end{aligned} \quad (2.8)$$

and the result holds for all  $t \geq s + k$  by induction.

2. By (2.8), for any  $n \geq s$ ,  $\lambda(n, m + 1) > \lambda(n, m)$  for  $m \geq k$ .

□

Now the ratios  $\lambda(n, m + 1)/\lambda(n, m)$  are considered. It is slightly more convenient to work with the reciprocals  $\lambda(n, m)/\lambda(n, m + 1)$ . Once again working with diagonal sets of nodes proves to be easiest.

**Lemma 2.2.** *For each  $t = s + k + 1, s + k + 2, \dots$  the sequence of ratios  $\{\lambda(t - m, m - 1)/\lambda(t + 1 - m, m) : k \leq m \leq t + 1 - s\}$  is increasing in  $m$ .*

*Proof.* The case  $t = s + k + 1$  is readily established by direct calculation. Suppose that the result has been established for some  $t - 1$  where  $t \geq s + k + 2$ . Introduce the notation  $\ell_m = \lambda(t - 1 - m, m)$ ,  $L_m = \lambda(t - m, m)$  to simplify the expressions. Next it is shown that  $\{L_{m-1}/L_m : m \geq k\}$  is increasing. Using (2.7)

$$\frac{L_m}{L_{m+1}} = \frac{m\ell_{m-1} + (t - m)\ell_m}{(m + 1)\ell_m + (t - 1 - m)\ell_{m+1}}, \quad \frac{L_{m-1}}{L_m} = \frac{(m - 1)\ell_{m-2} + (t + 1 - m)\ell_{m-1}}{m\ell_{m-1} + (t - m)\ell_m}$$

so (after cross-multiplying) the aim is to show that

$$L_m^2 - L_{m+1}L_{m-1} > 0 \quad \text{for } m = k, k + 1, \dots, t + 1 - s. \quad (2.9)$$

From the induction hypothesis it follows that  $\Delta_m^2 \equiv \ell_m^2 - \ell_{m+1}\ell_{m-1} > 0$  for  $m = k, \dots, t - s$  and similarly that for  $k + 1 \leq m \leq t + 1 - s$ ,

$$\Gamma_1 \equiv \ell_m\ell_{m-1} - \ell_{m+1}\ell_{m-2} = \ell_{m+1}\ell_{m-1} \left( \frac{\ell_m}{\ell_{m+1}} - \frac{\ell_{m-2}}{\ell_{m-1}} \right) > 0$$

( $\Gamma_1 = 0$  when  $m = k$  since  $\ell_{k-1} = \ell_{k-2} = 0$ ). Further from Lemma 2.1

$$\Gamma_2 \equiv \ell_m\ell_{m-2} + \ell_{m+1}\ell_{m-1} - \ell_{m+1}\ell_{m-2} - \ell_m\ell_{m+1} = (\ell_{m-2} - \ell_{m-1})(\ell_m - \ell_{m+1}) > 0$$

for  $k + 1 \leq m \leq t - s$  with  $\Gamma_2 = 0$  when  $m = k$  or  $m = t + 1 - s$ . For  $k \leq m \leq t + 1 - s$

$$t^2(L_m^2 - L_{m+1}L_{m-1}) = m^2\Delta_{m-1}^2 + (t - m)^2\Delta_m^2 + (m(t - m) - t)\Gamma_1 + \Gamma_2 > 0$$

as  $m(t - m) > t$ . Thus (2.9) holds and the result for all  $t \geq s + k + 1$  follows by induction. □

**Theorem 2.1.** For any fixed  $n \geq s$ ,

$$\frac{\lambda(n, m)}{\lambda(n, m+1)} > \frac{\lambda(n, m-1)}{\lambda(n, m)} \quad \text{for } m \geq k.$$

*Proof.* The inequality is trivial when  $m = k$  so suppose  $m \geq k + 1$ . From (2.7) and Lemma 2.1 (1)

$$\frac{\lambda(n, m+1)}{\lambda(n, m)} < \frac{m}{n+m} + \frac{n}{n+m} \frac{\lambda(n-1, m+1)}{\lambda(n, m)}$$

while from (2.7) (at  $(n, m)$  instead of  $(n, m+1)$ )

$$\frac{\lambda(n, m)}{\lambda(n, m-1)} = \frac{m}{n+m} + \frac{n}{n+m} \frac{\lambda(n-1, m)}{\lambda(n, m-1)}.$$

It follows immediately that

$$\frac{\lambda(n-1, m+1)}{\lambda(n, m)} < \frac{\lambda(n-1, m)}{\lambda(n, m-1)} \implies \frac{\lambda(n, m+1)}{\lambda(n, m)} < \frac{\lambda(n, m)}{\lambda(n, m-1)}.$$

It is thus sufficient to show, in the notation of Lemma 2, that  $L_{m+1}/L_m < \ell_m/\ell_{m-1}$ .

Expanding  $L_{m+1}$  and  $L_m$  using (2.7) and cross-multiplying leads to

$$\begin{aligned} [(m+1)\ell_m + (n-1)\ell_{m+1}]\ell_{m-1} &< [m\ell_{m-1} + n\ell_m]\ell_m \\ \Leftrightarrow \ell_m\ell_{m-1} - \ell_{m+1}\ell_{m-1} &< n(\ell_m^2 - \ell_{m+1}\ell_{m-1}) \\ \Leftrightarrow \ell_{m-1}(\ell_m - \ell_{m+1}) &< n\Delta_m^2. \end{aligned}$$

By Lemma 2.1 (1) the left-hand term is negative and by Lemma 2.2 the right-hand term is positive so the result is established.  $\square$

#### Example 2.4

The redundancy allocation algorithm presented in Section 2.5.1 is illustrated via a basic system consisting initially of four independent  $k^i$ -out-of- $m^i$  subsystems in series configuration with the values  $k^i$  and  $m^i$  as given in Table 2.6. Several scenarios of allocation of additional components, to increase redundancy optimally, will be illustrated for this system, with different numbers of successes in the tests of different components. Throughout this example, we assume that 5 components of each type were tested, so  $n^i = 5$  for  $i = 1, \dots, 4$ .

Table 2.7 presents the optimal allocation sequences of 5 extra components for zero-failure tests and for tests in which a single component of one type failed. In

$i$	$k^i$	$m^i$
1	1	2
2	2	3
3	3	5
4	1	4

Table 2.6: Subsystem  $i$ :  $k^i$ -out-of- $m^i$ 

$(s^1, s^2, s^3, s^4)$	sequence	initial reliability	final reliability
(5, 5, 5, 5)	2-3-1-2-3	0.7733	0.9259
(4, 5, 5, 5)	1-2-3-1-2	0.6960	0.8877
(5, 4, 5, 5)	2-2-3-2-1	0.6186	0.8677
(5, 5, 4, 5)	3-2-3-3-1	0.6227	0.8479
(5, 5, 5, 4)	2-3-1-2-3	0.7485	0.8963

Table 2.7: Optimal allocation sequences of 5 components

addition, for each case, the initial reliability of the system is given, so before any extra components have been allocated, as well as the final reliability after the 5 extra components have been allocated according to the optimal sequence.

For example, in the second case in Table 2.7, where one component exchangeable with those in subsystem 1 (say ‘of type 1’) has failed during testing, the optimal allocation of 5 extra components, to achieve maximal improvement of reliability of the overall system, is to first assign an extra component to subsystem 1, then one to subsystem 2, followed by extra components to subsystems 3, 1 and 2, in that order. It is clear from this example, and also obvious from the optimal allocation algorithm presented above, that if a tested component of a specific type has failed, then the corresponding subsystem tends to be assigned one or more extra components earlier in the optimal sequence when compared to the same system but without that test failure. If this happens, the order of added components for the other subsystems, for which no corresponding tested components failed during testing, remains unchanged.

$(s^1, s^2, s^3, s^4)$	sequence	initial reliability	final reliability
(5, 5, 5, 5)	2-3-1-2-3-2-3-1-3-2-1-4	0.7733	0.9742
(5, 5, 5, 4)	2-3-1-2-3-4-2-3-1-4-3-2	0.7485	0.9595
(5, 5, 5, 3)	2-3-4-1-2-4-3-4-2-4-3-1	0.6867	0.9295
(5, 5, 5, 2)	4-2-4-3-4-1-4-2-4-3-4-4	0.5630	0.8556
(5, 5, 5, 1)	4-4-4-2-4-4-3-4-1-4-4-2	0.3464	0.6460

Table 2.8: Optimal allocation sequences of 12 components

For the zero-failure case, so with  $s^i = 5$  for all  $i = 1, \dots, 4$ , this example was also presented by Coolen-Schrijner *et al.* [29] who showed that, due to the fact that subsystem 4, a 1-out-of-4 (parallel) system, has the largest built-in redundancy, the first extra component added to this subsystem is actually only the 12th in the optimal allocation sequence. This sequence of the first 12 extra components is presented again in Table 2.8, together with corresponding sequences for situations with one or more components of type 4 failing in the test, while no other components failed. This clearly illustrates that, for an increasing number of failed components of a particular type in the test, one allocates extra components to the corresponding subsystem earlier in the optimal sequence. For the last case, with only 1 out of 5 components of type 4 functioning successfully in the test, one clearly adds a large number of extra components to subsystem 4, but the effect of reduced component reliability still causes the final reliability to be substantially smaller than for the other test results and optimal allocation sequences reported.

## 2.6 Redundancy allocation with component costs

This section presents the inclusion of different costs per component of the different types. The results in the previous section determine how to optimally allocate additional components for redundancy for any criterion in the case where the cost of components is irrelevant, or where they are the same for all components. If the costs of additional components differ per subsystem, and one aims to maximize system reliability under budget constraints, then the redundancy allocation problem

becomes more complex. This problem can be formulated as follows:

Let  $c^i$  be the cost to add one extra component to subsystem  $i$ . Then the total cost of these additional components being added to the whole system is:

$$C(\mathbf{j}) = C(j^1, \dots, j^L) = \sum_{i=1}^L c^i j^i$$

Obtaining optimal system reliability with a fixed budget  $B$  means that we need to add  $J$  additional components to the whole system ( $J = \sum_{i=1}^L j^i$ ) in order to

$$\text{maximize} \quad \prod_{i=1}^L \prod_{l^i=0}^{j^i-1} \rho(i, l^i)$$

subject to the restriction

$$\sum_{i=1}^L c^i j^i \leq B \quad j^i \geq 0 \quad \forall i = 1, \dots, L$$

This goal function can be replaced by: maximize  $\sum_{i=1}^L \sum_{l^i=0}^{j^i-1} \ln(\rho(i, l^i))$ . This problem is close in nature to the well-known knapsack problems in discrete optimisation [43]. The knapsack problem is a problem of how to choose items to maximize their total value under a constraint of maximal weight. Let us assume that we can choose from items  $1, \dots, n$  with weights  $a^1, a^2, \dots, a^n$  and profits  $p^1, p^2, \dots, p^n$ . The capacity of the knapsack  $K \in \mathbb{N}$  is also given. The task is now to select a subset of the items so that its total weight does not exceed  $K$  and its profit is maximized among those subsets. The integer program formulation of the knapsack problem is the following. For all  $i = 1, \dots, n$  we have a variable  $x^i \in \{0, 1\}$ ,

$$\text{maximize} \quad \sum p^i x^i$$

subject to

$$\sum a^i x^i \leq K$$

There are different versions of the knapsack problem [43], for example the single knapsack problem is the case where one container (or knapsack) must be filled with an optimal subset of items. If more than one container is available, the multiple knapsack problem will be considered. Also, according to the number of copies allocated of each item one can distinguish between the unbounded knapsack problem,

$i$	$k^i$	$m^i$	$c^i$
1	3	4	5
2	2	3	4
3	4	6	3
4	2	4	6

Table 2.9: Subsystem  $i$ :  $k^i$ -out-of- $m^i$ 

which places no bound on the number of each item, and the bounded knapsack problem, which restricts the number of each item to a maximum value. The typical formulation in practice is the 0-1 knapsack problem, where only one copy of each item is available.

The system considered in this chapter consists of series configurations of  $L$  independent  $k^i$ -out-of- $m^i$  subsystems. For each  $i = 1, \dots, L$ ,  $\rho(i, j^i)$  is strictly decreasing in  $j^i$ , but  $c^i$  is assumed to be fixed. It means that the extra components to be allocated with cost (weight)  $c^i$  and utility (value)  $\ln \rho(i, l^i)$  are not the same. This allocation problem is considered as a 0-1 knapsack problem, which can be solved by basic dynamic programming.

### Example 2.5

The redundancy allocation under fixed budget  $B$  using a knapsack problem formulation is illustrated via a basic system consisting initially of four independent  $k^i$ -out-of- $m^i$  subsystems in series configuration, with the values  $k^i$ ,  $m^i$  and  $c^i$  as given in Table 2.9. Several scenarios of allocation of additional components, under different budgets, will be illustrated for this system. Throughout this example, we assume that 5 components of each type were tested, so  $n^i = 5$  for  $i = 1, \dots, 4$ . To concentrate on the effect of the budget  $B$ , we assume zero-failure testing, so  $s^i = 5$  for  $i = 1, \dots, 4$ .

Budget $B$	extra components to each subsystem $i$					final reliability
	1	2	3	4	total	
17	2	1	1	0	4	0.8046
18	1	1	3	0	5	0.8082
19	1	2	2	0	5	0.8151
20	2	1	2	0	5	0.8281
21	2	1	2	0	5	0.8281
22	1	2	3	0	6	0.8284
23	2	1	3	0	6	0.8416
24	2	2	2	0	6	0.8488

Table 2.10: Optimal allocation of the components for different budgets

Table 2.10 presents the optimal allocation of the extra components for budget  $B$  varying from 17 to 24. In addition, for each case, the optimal final reliability after extra components have been allocated is given, the initial reliability of this system is 0.6227.

Table 2.10 shows that increasing the budget has different effects on the allocation of the extra components added to the system. For example, increasing the budget from 17 to 18 results in increasing the extra components added to subsystem 3 to 3, and reducing the extra components added to subsystem 1 to 1 with one extra component added to the whole system. However, increasing the budget from 18 to 19 does not increase the total number of extra components added to the whole system, but it assigns a different number to some subsystems. Increasing the budget from 20 to 21 has no effect.

## 2.7 Concluding remarks

Coolen-Schrijner *et al.* [29] presented the basic application of NPI for Bernoulli random quantities to inference on reliability of a system which consists of several  $k^i$ -out-of- $m^i$  subsystems in series configuration. They proved that the NPI model



is very tractable, enabling a powerful optimal redundancy allocation algorithm, but they only derived this result for redundancy allocation following zero-failure testing. In this chapter, this algorithm is proven to be optimal for redundancy allocation for such systems following any test results (as long as at least one component of each type functioned successfully in the tests), which is a powerful result for practical application of this algorithm.

Redundancy allocation with a fixed budget using the knapsack problem is presented in this chapter as a first step to inclusion of different costs per component of the different types. Further steps could involve the opportunity to reduce the  $k^i$  of a subsystem, which in practice could e.g. be achieved either by a change to the demands on the subsystem or by guaranteeing that an installed component will actually function, this may be possible if components can be analyzed in great detail. Perhaps more important from practical perspective is the generalization with different losses taken into account, corresponding to failures of different subsystems, which can be considered as different failure modes. This is important in situations where such systems have multiple failure modes, and in particular where the losses incurred by failures due to different failure modes vary substantially. Further aspects of testing can also be considered, for example time required to test different components, with restrictions on overall time available for testing. Also, one needs to determine how many zero-failure tests are required in order to demonstrate reliability. Coolen and Coolen-Schrijner [23] and Rahrouh *et al.* [47] present related theory of reliability demonstration from the perspectives of NPI and Bayesian statistics.

# Chapter 3

## Subsystems consisting of one type of component

### 3.1 Introduction

In the previous chapter we have presented nonparametric predictive inference (NPI) for system reliability, with specific attention to redundancy allocation. Series systems were considered in which each subsystem  $i$  is a  $k^i$ -out-of- $m^i$  system. The different subsystems were assumed to consist of different types of components, each type having undergone prior success-failure testing. In this chapter, these results are generalized by allowing different  $k^i$ -out-of- $m^i$  subsystems to consist of components of the same type. Such components are exchangeable with regard to the information about them contained in test results but they play different roles in the system if they are in different subsystems.

In Section 3.2 NPI lower and upper probabilities for series of  $k^i$ -out-of- $m^i$  subsystems consisting of single-type components are derived by counting paths on the grid, in a similar way as described in Chapter 2. We start with series of two  $k^i$ -out-of- $m^i$  subsystems. Then the results are generalized to systems with  $L > 2$   $k^i$ -out-of- $m^i$  subsystems. The NPI lower and upper cumulative joint distribution functions for the event of interest are presented. Examples in Section 3.3 illustrate these NPI lower and upper probabilities for system functioning. Section 3.4 contains some concluding remarks.

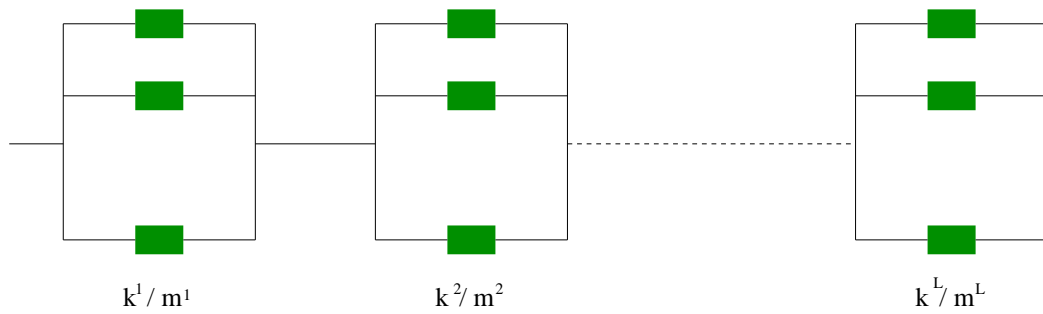

Figure 3.1: Series of  $L$   $k^i$ -out-of- $m^i$  subsystems consisting of single-type components

## 3.2 Series of subsystems consisting of single-type components

Consider a system consisting of a series configuration of  $L$   $k^i$ -out-of- $m^i$  subsystems, with the subsystems consisting of components of the same type (see Figure 3.1). Such components are exchangeable with regard to the information about them contained in test results, but they play different roles in the system if they are in different subsystems. To apply the NPI approach for such a system,  $n$  components that are exchangeable with the  $m$  ( $m = m^1 + \dots + m^L$ ) components in the system considered, have to be tested. The event that such a system functions successfully is denoted by  $S^{[L]}(m^1 : k^1, \dots, m^L : k^L)$ . The aim is to derive the NPI lower and upper probabilities for the event that the system functions given the test data,

$$\underline{P}(S^{[L]}(m^1 : k^1, \dots, m^L : k^L) \mid (n, s))$$

and

$$\overline{P}(S^{[L]}(m^1 : k^1, \dots, m^L : k^L) \mid (n, s))$$

respectively.

Before presenting the general results for any number  $L$  of subsystems, the case of a system consisting of  $L = 2$  subsystems is considered in detail.

### 3.2.1 Two subsystems

Consider a system which consists of a series configuration of two  $k^i$ -out-of- $m^i$  subsystems. These subsystems consist of components of the same type (see Figure

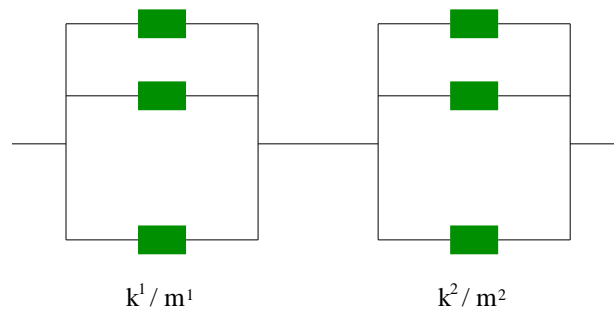

Figure 3.2: Series of 2  $k^i$ -out-of- $m^i$  subsystems consisting of single-type components

3.2). Let  $Y_{n+1}^{n+m^1}$  and  $Y_{n+m^1+1}^{n+m^1+m^2}$  denote the random number of successes in trials  $n+1$  to  $n+m^1$  and  $n+m^1+1$  to  $n+m^1+m^2$ , respectively. The event  $(Y_{n+1}^{n+m^1} \geq k^1 \cap Y_{n+m^1+1}^{n+m^1+m^2} \geq k^2)$  is of interest as this corresponds to successful functioning of this system, following  $n$  tests of components that are exchangeable with the  $m = m^1 + m^2$  components in the system considered. The NPI lower probability for this event is

$$\begin{aligned} \underline{P}(Y_{n+1}^{n+m^1} \geq k^1, Y_{n+m^1+1}^{n+m^1+m^2} \geq k^2 \mid Y_1^n = s) &= \underline{P}(S^{[2]}(m^1 : k^1, m^2 : k^2) \mid (n, s)) = \\ &= \binom{n+m^1+m^2}{n, m^1, m^2}^{-1} \sum_{l^1=k^1}^{m^1} \sum_{l^2=k^2}^{m^2} \binom{s-1+l^1+l^2}{s-1, l^1, l^2} \binom{n-s+m^1-l^1+m^2-l^2}{n-s, m^1-l^1, m^2-l^2} \end{aligned}$$

and the corresponding NPI upper probability is

$$\begin{aligned} \overline{P}(Y_{n+1}^{n+m^1} \geq k^1, Y_{n+m^1+1}^{n+m^1+m^2} \geq k^2 \mid Y_1^n = s) &= \overline{P}(S^{[2]}(m^1 : k^1, m^2 : k^2) \mid (n, s)) = \\ &= \binom{n+m^1+m^2}{n, m^1, m^2}^{-1} \left[ \sum_{l^2=k^2}^{m^2} \binom{s+k^1-1+l^2}{s, k^1-1, l^2} \binom{n-s+m^1-k^1+m^2-l^2}{n-s, m^1-k^1, m^2-l^2} + \right. \\ &\quad \left. \sum_{l^1=k^1}^{m^1} \binom{s+l^1+k^2-1}{s, l^1, k^2-1} \binom{n-s+m^1-l^1+m^2-k^2}{n-s, m^1-l^1, m^2-k^2} + \right. \\ &\quad \left. \sum_{l^1=k^1}^{m^1} \sum_{l^2=k^2}^{m^2} \binom{s-1+l^1+l^2}{s-1, l^1, l^2} \binom{n-s+m^1-l^1+m^2-l^2}{n-s, m^1-l^1, m^2-l^2} \right] \end{aligned}$$

These NPI lower and upper probabilities are derived by counting paths on the grid from  $(0, 0, 0)$  to  $(n, m^1, m^2)$ , in a similar way as described in Chapter 2. By the appropriate  $A_{(n)}$  assumptions, all orderings of the  $n+m^1+m^2$  latent variables representing the  $n$  test observations and the  $m^1$  and  $m^2$  future random quantities are again equally likely, and each such an ordering can again be represented by a unique

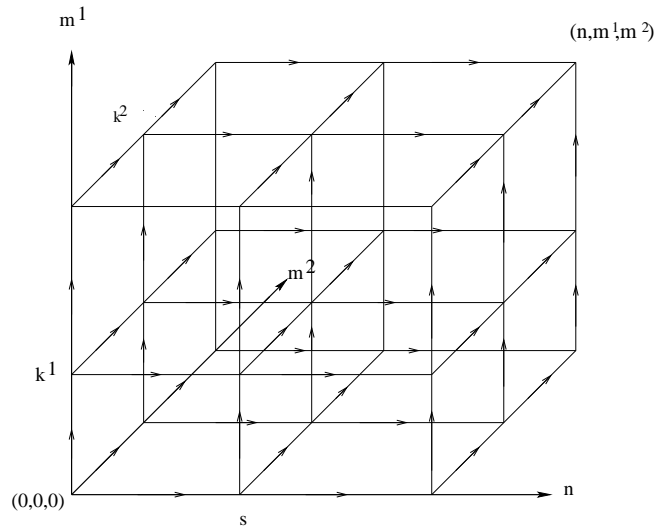

Figure 3.3: All possible paths from the point  $(0,0,0)$  to the point  $(n, m^1, m^2)$

path from  $(0, 0, 0)$  to  $(n, m^1, m^2)$  (see Figure 3.3). The above NPI lower probability follows by counting all paths which go through  $(s, r^1, r^2)$  for  $r^1 \geq k^1$  and  $r^2 \geq k^2$  but not through any point  $(s, r^1, r^2)$  with  $r^1$  less than  $k^1$  or with  $r^2$  less than  $k^2$ . The corresponding NPI upper probability follows by counting all such paths that go through at least one point  $(s, r^1, r^2)$  with  $r^1 \geq k^1$  and  $r^2 \geq k^2$ .

### 3.2.2 $L \geq 2$ subsystems

Using similar counting arguments on an  $L + 1$ -dimensional grid, the NPI lower and upper probabilities for successful functioning of the system consisting of a series configuration of  $L \geq 2$   $k^i$ -out-of- $m^i$  subsystems with single-type components, are

$$\underline{P}(S^{[L]}(m^1 : k^1, \dots, m^L : k^L) \mid (n, s)) = \binom{n + m^1 + \dots + m^L}{n, m^1, \dots, m^L}^{-1} \sum_{l^L=k^L}^{m^L} \dots \sum_{l^1=k^1}^{m^1} \binom{s-1+l^1+\dots+l^L}{s-1, l^1, \dots, l^L} \binom{n-s+m^1-l^1+\dots+m^L-l^L}{n-s, m^1-l^1, \dots, m^L-l^L}$$

and

$$\overline{P}(S^{[L]}(m^1 : k^1, \dots, m^L : k^L) \mid (n, s)) = \binom{n + m^1 + \dots + m^L}{n, m^1, \dots, m^L}^{-1} \left[ \sum_{i=1}^L A_i + \sum_{l^L=k^L}^{m^L} \dots \sum_{l^1=k^1}^{m^1} \binom{s-1+l^1+\dots+l^L}{s-1, l^1, \dots, l^L} \binom{n-s+m^1-l^1+\dots+m^L-l^L}{n-s, m^1-l^1, \dots, m^L-l^L} \right]$$

where

$$A_i = \sum_{l^1=k^1}^{m^1} \cdots \sum_{l^{i-1}=k^{i-1}}^{m^{i-1}} \sum_{l^{i+1}=k^{i+1}}^{m^{i+1}} \cdots \sum_{l^L=k^L}^{m^L} \binom{s+l^1+\cdots+l^{i-1}+k^i-1+l^{i+1}+\cdots+l^L}{s, l^1, \dots, l^{i-1}, k^i-1, l^{i+1}, \dots, l^L} \\ \times \binom{n-s+m^1-l^1+\cdots+m^{i-1}-l^{i-1}+m^i-k^i+m^{i+1}-l^{i+1}+\cdots+m^L-l^L}{n-s, m^1-l^1, \dots, m^{i-1}-l^{i-1}, m^i-k^i, m^{i+1}-l^{i+1}, \dots, m^L-l^L}$$

For example, the NPI lower and upper probabilities for successful functioning of the system consisting of a series configuration of  $L = 3$   $k^i$ -out-of- $m^i$  subsystems with single-type components are:

$$\underline{P}(S^{[3]}(m^1 : k^1, m^2 : k^2, m^3 : k^3) | (n, s)) = \binom{n+m^1+m^2+m^3}{n, m^1, m^2, m^3}^{-1} \\ \sum_{l^1=k^1}^{m^1} \sum_{l^2=k^2}^{m^2} \sum_{l^3=k^3}^{m^3} \binom{s-1+l^1+l^2+l^3}{s-1, l^1, l^2, l^3} \binom{n-s+m^1-l^1+m^2-l^2+m^3-l^3}{n-s, m^1-l^1, m^2-l^2, m^3-l^3}$$

$$\overline{P}(S^{[3]}(m^1 : k^1, m^2 : k^2, m^3 : k^3) | (n, s)) = \binom{n+m^1+m^2+m^3}{n, m^1, m^2, m^3}^{-1} \times \\ \left[ \sum_{l^2=k^2}^{m^2} \sum_{l^3=k^3}^{m^3} \binom{s+k^1-1+l^2+l^3}{s, k^1-1, l^2, l^3} \binom{n-s+m^1-k^1+m^2-l^2+m^3-l^3}{n-s, m^1-k^1, m^2-l^2, m^3-l^3} \right. \\ + \sum_{l^1=k^1}^{m^1} \sum_{l^3=k^3}^{m^3} \binom{s+l^1+k^2-1+l^3}{s, l^1, k^2-1, l^3} \binom{n-s+m^1-l^1+m^2-k^2+m^3-l^3}{n-s, m^1-l^1, m^2-k^2, m^3-l^3} \\ + \sum_{l^1=k^1}^{m^1} \sum_{l^2=k^2}^{m^2} \binom{s+l^1+l^2+k^3-1}{s, l^1, l^2, k^3-1} \binom{n-s+m^1-l^1+m^2-l^2+m^3-k^3}{n-s, m^1-l^1, m^2-l^2, m^3-k^3} \\ \left. + \sum_{l^1=k^1}^{m^1} \sum_{l^2=k^2}^{m^2} \sum_{l^3=k^3}^{m^3} \binom{s-1+l^1+l^2+l^3}{s-1, l^1, l^2, l^3} \binom{n-s+m^1-l^1+m^2-l^2+m^3-l^3}{n-s, m^1-l^1, m^2-l^2, m^3-l^3} \right]$$

In the same context it is convenient to present here the NPI lower and upper probabilities for the event  $(Y_{n+1}^{n+m^1} \leq k^1, Y_{n+m^1+1}^{n+m^1+m^2} \leq k^2, \dots, Y_{n+m^1+m^2+\dots+m^{L-1}+1}^{n+m^1+m^2+\dots+m^L} \leq k^L | Y_1^n = s)$  that will later be needed in Lemma 5.1 in Chapter 5. These NPI lower and upper cumulative distribution function(CDF) can also be derived by counting arguments similar to those presented above, and are as follows:

$$\underline{P}(Y_{n+1}^{n+m^1} \leq k^1, Y_{n+m^1+1}^{n+m^1+m^2} \leq k^2, \dots, Y_{n+m^1+m^2+\dots+m^{L-1}+1}^{n+m^1+m^2+\dots+m^L} \leq k^L | Y_1^n = s) = \\ \binom{n+m^1+\dots+m^L}{n, m^1, \dots, m^L}^{-1} \times \\ \sum_{l^1=0}^{k^1} \cdots \sum_{l^L=0}^{k^L} \left[ \binom{s+l^1+\dots+l^L}{s, l^1, \dots, l^L} \binom{n-s-1+m^1-l^1+\dots+m^L-l^L}{n-s-1, m^1-l^1, \dots, m^L-l^L} \right]$$



Figure 3.4: The Dutch Oosterscheldekering (source: earth.google.com)

and

$$\begin{aligned} \bar{P}(Y_{n+1}^{n+m^1} \leq k^1, Y_{n+m^1+1}^{n+m^1+m^2} \leq k^2, \dots, Y_{n+m^1+m^2+\dots+m^{L-1}+1}^{n+m^1+m^2+\dots+m^L} \leq k^L \mid Y_1^n = s) = \\ \binom{n+m^1+\dots+m^L}{n, m^1, \dots, m^L}^{-1} \times \\ \sum_{l^1=0}^{k^1} \dots \sum_{l^L=0}^{k^L} \left[ \binom{s-1+l^1+\dots+l^L}{s-1, l^1, \dots, l^L} \binom{n-s+m^1-l^1+\dots+m^L-l^L}{n-s, m^1-l^1, \dots, m^L-l^L} \right] \end{aligned}$$

The above NPI lower CDF follows by counting all paths which go through any pair  $(s, r^1, r^2)$  and  $(s+1, r^1, r^2)$  respectively for  $r^1 \leq k^1$  and  $r^2 \leq k^2$ . The corresponding NPI upper CDF probability follows by counting all such paths that go through any point  $(s, r^1, r^2)$  with  $r^1 \leq k^1$  and  $r^2 \leq k^2$ .

### 3.3 Examples

In this section the NPI lower and upper probabilities for successful functioning of the system considered in this chapter are illustrated via three related examples. Although these examples are purely illustrative for the presented theory, the numbers chosen are inspired by the Dutch Oosterscheldekering (Eastern Scheldt storm surge barrier), which is part of the Delta works series of dams to protect the Netherlands

$n$	$s$	$k = 58$		$k = 59$		$k = 60$		$k = 61$		$k = 62$	
		$\underline{P}$	$\overline{P}$	$\underline{P}$	$\overline{P}$	$\underline{P}$	$\overline{P}$	$\underline{P}$	$\overline{P}$	$\underline{P}$	$\overline{P}$
1	1	0.079	1	0.063	1	0.048	1	0.032	1	0.016	1
2	2	0.151	1	0.122	1	0.092	1	0.062	1	0.031	1
3	3	0.217	1	0.176	1	0.134	1	0.091	1	0.046	1
	2	0.021	0.217	0.014	0.176	0.008	0.134	0.004	0.091	0.001	0.046
5	5	0.330	1	0.272	1	0.211	1	0.145	1	0.075	1
	4	0.060	0.330	0.041	0.272	0.025	0.211	0.013	0.145	0.005	0.075
10	10	0.538	1	0.458	1	0.367	1	0.260	1	0.139	1
	9	0.192	0.538	0.139	0.458	0.090	0.367	0.049	0.260	0.018	0.139
	8	0.051	0.192	0.032	0.139	0.017	0.090	0.007	0.049	0.002	0.018
	7	0.011	0.051	0.006	0.032	0.003	0.017	0.001	0.007	0.000	0.002
20	20	0.763	1	0.681	1	0.573	1	0.431	1	0.244	1
30	30	0.868	1	0.800	1	0.699	1	0.548	1	0.326	1
40	40	0.922	1	0.867	1	0.780	1	0.633	1	0.392	1
50	50	0.952	1	0.910	1	0.834	1	0.696	1	0.446	1
60	60	0.969	1	0.936	1	0.872	1	0.744	1	0.492	1
62	62	0.971	1	0.941	1	0.878	1	0.752	1	0.500	1
100	100	0.993	1	0.980	1	0.946	1	0.855	1	0.617	1

Table 3.1: NPI lower and upper probabilities for a  $k$ -out-of-62 system

from flooding [18]. The Oosterscheldekering consists of three sections, with 15 steel doors in the northern section, 16 in the middle section, and 31 in the southern section (see Figure 3.4). The NPI lower and upper probabilities for successful functioning of the system in these examples could be interpreted as those for successful functioning of this barrier on a single application, following test results of  $n$  doors. Of course, this assumes exchangeability of the functioning of the individual doors, which may not be deemed to be an appropriate assumption. In Example 3.1 we start with a single  $k$ -out-of-62 system. In Examples 3.2 and 3.3 we regard this system as consisting of two or three  $k^i$ -out-of- $m^i$  systems.



**Example 3.1**

In this example we suppose that the barrier consists of 62 steel doors next to each other in one line. Table 3.1 presents the NPI lower and upper probabilities for a  $k$ -out-of-62 system, with  $k$  varying from 58 to 62, on the basis of tests of  $n$  components that are exchangeable with the 62 components in the system, and  $s$  components in the tests functioning successfully.

If tests have revealed no failures, so  $s = n$ , then the NPI upper probability of system functioning is equal to 1, which reflects that such tests do not contain evidence against the possibility that such components would always function. The corresponding lower probabilities in these cases are increasing in the number of tests, if the tests did not reveal any failures, which reflects the increasing evidence in favour of at least  $k$  components out of 62 functioning in the system. With relatively few tests performed, and many of the 62 components in the system required to function, the effect of a failure in the tests on the predicted system reliability is substantial. This example illustrates that  $\bar{P}(S(m : k) | (n, s)) = \underline{P}(S(m : k) | (n, s + 1))$ , which generally holds for these NPI lower and upper probabilities [29]. It is worth noticing the lower probability  $\underline{P}(S(62 : 62) | (62, 62)) = 0.5$ , which is actually precisely  $1/2$  and is the same as would be derived if the whole 62-out-of-62 system were instead considered to be a single unit, and if one exchangeable unit (hence also such a system) had been tested and had been successful, as  $\underline{P}(S(1 : 1) | (1, 1)) = 0.5$ . Table 3.1 shows that the lower and upper probabilities are decreasing in  $k$  when keeping  $m$  and  $n$  constant, and increasing in  $n$  when keeping  $m$  and  $k$  constant. This is most obvious from the large differences between the values at the top left and bottom right of Table 3.1.

**Example 3.2**

As we mentioned before, the Oosterscheldekering consists of three sections, with 15 steel doors in the northern section, 16 in the middle section, and 31 in the southern section. Suppose now that the functioning of the barrier requires specific numbers of doors in each section to function. The assumption of exchangeability of the doors remains with regard to the uncertainty of their functioning and the way in which

$n$	$s$	$k^1 = k^2 = 29$		$k^1 = 29, k^2 = 30$		$k^1 = k^2 = 30$		$k^1 = k^2 = 31$	
		$\underline{P}$	$\overline{P}$	$\underline{P}$	$\overline{P}$	$\underline{P}$	$\overline{P}$	$\underline{P}$	$\overline{P}$
1	1	0.066	1	0.050	1	0.040	1	0.016	1
2	2	0.126	1	0.096	1	0.077	1	0.031	1
3	3	0.182	1	0.139	1	0.113	1	0.046	1
	2	0.015	0.182	0.010	0.139	0.006	0.113	0.001	0.046
5	5	0.280	1	0.218	1	0.178	1	0.075	1
	4	0.045	0.280	0.028	0.218	0.019	0.178	0.005	0.075
10	10	0.467	1	0.375	1	0.314	1	0.139	1
	9	0.148	0.467	0.099	0.375	0.070	0.314	0.018	0.139
	8	0.036	0.148	0.020	0.099	0.012	0.070	0.002	0.018
	7	0.007	0.036	0.003	0.020	0.002	0.012	0.000	0.002
20	20	0.687	1	0.579	1	0.503	1	0.244	1
30	30	0.803	1	0.701	1	0.625	1	0.326	1
40	40	0.868	1	0.778	1	0.708	1	0.392	1
50	50	0.908	1	0.829	1	0.766	1	0.446	1
60	60	0.934	1	0.865	1	0.809	1	0.492	1
62	62	0.938	1	0.871	1	0.816	1	0.500	1
100	100	0.977	1	0.936	1	0.901	1	0.617	1

Table 3.2: NPI lower and upper probabilities with  $m^1 = m^2 = 31$ 

we learn from test data on similar doors. For the functioning of the system it is important to distinguish the doors according to which section they are in. In this example, suppose that the northern and middle sections can be combined to one  $k^1$ -out-of-31 subsystem, with the southern section a separate  $k^2$ -out-of-31 subsystem, and these two subsystems form together the overall system in series configuration. Some NPI lower and upper probabilities for functioning of the whole system are presented in Table 3.2.

Comparing Tables 3.1 and 3.2, it is clear that the lower and upper probabilities in the final columns, where the system only functions if all components function, are

$n$	$s$	$k = 15, m = 15$		$k = 16, m = 16$		$k = 30, m = 31$		$k = 31, m = 31$	
		$\underline{P}$	$\overline{P}$	$\underline{P}$	$\overline{P}$	$\underline{P}$	$\overline{P}$	$\underline{P}$	$\overline{P}$
1	1	0.063	1	0.059	1	0.063	1	0.031	1
2	2	0.118	1	0.111	1	0.119	1	0.061	1
3	3	0.167	1	0.158	1	0.171	1	0.088	1
	2	0.020	0.167	0.018	0.158	0.016	0.171	0.005	0.088
5	5	0.250	1	0.238	1	0.262	1	0.139	1
	4	0.053	0.250	0.048	0.238	0.045	0.262	0.016	0.139
10	10	0.400	1	0.385	1	0.433	1	0.244	1
	9	0.150	0.400	0.138	0.385	0.142	0.433	0.055	0.244
	8	0.052	0.15	0.046	0.138	0.039	0.142	0.011	0.055
	7	0.017	0.052	0.014	0.046	0.009	0.039	0.002	0.011
20	20	0.571	1	0.556	1	0.635	1	0.392	1
30	30	0.667	1	0.651	1	0.746	1	0.492	1
40	40	0.727	1	0.714	1	0.813	1	0.563	1
50	50	0.769	1	0.758	1	0.856	1	0.617	1
60	60	0.800	1	0.789	1	0.886	1	0.659	1
62	62	0.805	1	0.795	1	0.891	1	0.667	1
100	100	0.870	1	0.862	1	0.945	1	0.763	1

Table 3.3: NPI lower and upper probabilities for  $k$ -out-of- $m$  systems

identical. This is logical, as in both cases it just means that, after  $n$  components have been tested, the next components must all function. The three other cases presented in Table 3.2 do not directly relate to cases in Table 3.1, due to the different system configurations. Clearly, a 60-out-of-62 system can function for more combinations of failing components than two 30-out-of-31 subsystems in a series configuration, namely the former still functions if the two failing components happen to be in the same subsystem corresponding to it, in which case the latter would not function anymore. This explains why the entries (except those equal to 1) in Table 3.1 are greater than corresponding ones in Table 3.2, where we relate the cases  $k = 60$  with  $k^1 = k^2 = 30$  and also  $k = 58$  with  $k^1 = k^2 = 29$ .

$(k^1, k^2, k^3) :$		(14, 15, 30)		(15, 16, 30)		(15, 16, 31)	
$n$	$s$	$\underline{P}$	$\overline{P}$	$\underline{P}$	$\overline{P}$	$\underline{P}$	$\overline{P}$
1	1	0.045	1	0.024	1	0.016	1
2	2	0.087	1	0.047	1	0.031	1
3	3	0.127	1	0.069	1	0.046	1
	2	0.008	0.127	0.003	0.069	0.001	0.046
5	5	0.197	1	0.110	1	0.075	1
	4	0.024	0.197	0.009	0.110	0.005	0.075
10	10	0.345	1	0.200	1	0.139	1
	9	0.085	0.345	0.033	0.200	0.018	0.139
	8	0.016	0.085	0.005	0.033	0.002	0.018
	7	0.003	0.016	0.001	0.005	0.000	0.002
20	20	0.542	1	0.337	1	0.244	1
30	30	0.664	1	0.437	1	0.326	1
40	40	0.744	1	0.513	1	0.392	1
50	50	0.799	1	0.571	1	0.446	1
60	60	0.838	1	0.618	1	0.492	1
62	62	0.844	1	0.626	1	0.500	1
100	100	0.919	1	0.736	1	0.617	1

Table 3.4: NPI lower and upper probabilities with  $m^1 = 15, m^2 = 16, m^3 = 31$ **Example 3.3**

Let us now consider the system of 62 components split up into three subsystems, with  $m^1 = 15, m^2 = 16$  and  $m^3 = 31$  components, inspired by the three sections of the Oosterscheldekering. First, let us consider the reliability of each of these three subsystems independently of each other, so we consider each as a single  $k$ -out-of- $m$  system. The NPI lower and upper probabilities for successful functioning of each of these systems individually, based on  $s$  successfully functioning components in  $n$  tests, are given in Table 3.3, for the values  $k$  and  $m$  as indicated in the columns.

These NPI lower and upper probabilities give an indication of the reliability of the individual subsystems considered, when considering them independently of the other systems. It is crucial, however, that in the application in this example, these subsystems consist of the same type of component, for which only limited test information is available. Hence, if it were known that one of these subsystems functions satisfactorily, let us assume this would be the subsystem with  $m = 15$  and assuming that this would function only if  $k = 15$ , then for the next subsystem considered we are more confident in the reliability of the components, as now in addition to the test results for the  $n$  tested components it is known that a further 15 components all function satisfactorily. This has a substantial impact on overall reliability when we combine the subsystems into a single system.

If one were to neglect the interdependence of the components in the different subsystems, one would make the mistake of quantifying the system's reliability by multiplying the NPI lower and upper probabilities of successful functioning of the subsystems, as mentioned in Chapter 2 for independent subsystems. For example, consider the third column of Table 3.2, involving a series system with two 30-out-of-31 subsystems on the basis of  $s$  components functioning well out of  $n$  components tested. If we would, instead, multiply the lower and upper probabilities for two individual 30-out-of-31 systems, based on the same test information, so effectively we would take the squared values of the entries in the third column in Table 3.3, then the latter would lead to substantially smaller values for the lower probability, and also for the upper probability for all cases where this is not equal to one. To illustrate this important issue, assume that  $n = 10$  components had been tested, of which  $s = 9$  functioned successfully. The corresponding NPI lower and upper probabilities for successful functioning of the series system with two 30-out-of-31 subsystems (Table 3.2, third column) are 0.070 and 0.314, respectively. If one would, mistakenly, neglect the interdependence of these two subsystems, which use components of the same type, and multiply the NPI lower and upper probabilities for the individual 30-out-of-31 subsystems (Table 3.3, third column), this would lead to the values  $0.142^2 = 0.020$  for the lower and  $0.433^2 = 0.187$  for the upper probability, which are substantially smaller than the correct values.

Let us now consider the 62-component system as consisting of three subsystems in series structure, with  $m^1 = 15$ ,  $m^2 = 16$  and  $m^3 = 31$  components. Table 3.4 presents NPI lower and upper probabilities for some situations reflecting satisfactory functioning of the whole system depending on the specific numbers  $k^i$  ( $i = 1, 2, 3$ ) of components required to function per subsystem.

Again, if all 62 components need to function ( $k^i = m^i$  for all  $i$ ), then the NPI lower and upper probabilities are as in Tables 3.1 and 3.2 for the same situation. Suppose that the whole system functions satisfactorily if in each subsystem not more than one component fails, leading to the NPI lower and upper probabilities in the first column of Table 3.4. If we had not separated the two smallest subsystems, so instead had assumed that the whole system consisted of two subsystems with  $m^1 = m^2 = 31$ , as considered in Example 3.2 with corresponding NPI lower and upper probabilities given in Table 3.2, and if we had allowed two failing components for the first subsystem with  $m^1 = 31$  components, then (see column 2 in Table 3.2) the NPI lower and upper probabilities (the latter if different from 1) would have been larger than those with the three subsystems taken into account separately. This is due to the fact that there would be more combinations of the failing components included in the counts for the lower and upper probabilities in Table 3.2, namely those with two failing components in one, and zero in the other, of the individual subsystems with 15 and 16 components. This illustrates clearly that one must carefully define the requirements on the subsystems in order for the overall system to function, which is of course directly linked to the appropriate system structure.

Examples 3.1, 3.2 and 3.3 clearly show the effect of increasing numbers of tests on the system reliability. If all  $n$  components tested succeeded in their task, so  $s = n$ , then the NPI lower probabilities increase as function of  $n$ , but the rate of increase decreases. This is in line with intuition as it reflects that, with all tests being successful, the positive effect of a further successful test on the lower probability of system functioning decreases with increasing  $n$ . This can also be used to set a minimum number of tests, assuming no failures will be discovered, in order to meet a reliability requirement formulated as a minimum value for the NPI lower probability of system functioning. This is relevant in high-reliability testing, where failures in

tests typically lead to redesign of the units followed by a new stage of testing, and hence one needs to determine how many zero-failure tests are required in order to demonstrate reliability. Coolen and Coolen-Schrijner [23] and Rahrouh *et al.* [47] present related theory of reliability demonstration from the perspectives of NPI and Bayesian statistics.

### 3.4 Concluding remarks

This chapter presented an important step in the development of NPI for more complex system structures, as components of one type frequently occur in different subsystems. As a first step for this research, we have generalized NPI for Bernoulli quantities [12] to distinguish between subgroups of the  $m$  future observations, and we have derived lower and upper probabilities which quantify the reliability of such systems. A further important step will be presented in the next chapter namely NPI for reliability of voting systems with multiple component types.

In Chapter 2 an optimal algorithm was presented for redundancy allocation related to the NPI approach to reliability of systems consisting of independent  $k^i$ -out-of- $m^i$  subsystems, each consisting of a single type of component, which are different for different subsystems. The algorithm was proven to be optimal, and this algorithm is straightforward to implement and requires negligible computing time. This algorithm will be a basis for constructing an algorithm for a more general system in Chapter 4. Numerical examples indicate that a similarly attractive algorithm will again be optimal for the system in this chapter, but we have not managed to prove this as a general property.

# Chapter 4

## Voting systems with multiple component types

### 4.1 Introduction

It has been generally acknowledged that redundancy in systems leads to increased reliability. However, during the last decade there has been increasing debate about the value of redundancy, in particular highlighting the effect of common-cause failures or other kinds of dependent failures, where multiple components fail at the same time or in a small period of time, see for example Paté-Cornell *et al.* [46] and Hoepfer *et al.* [37]. It is typically argued that, whilst additional components in parallel system structures provide redundancy and increase system reliability, their positive effect may be restricted due to common-cause failures which possibly affect all components of a particular type. Whilst such common-cause failures can be taken into account [55], a natural solution lies in the combination of redundancy and diversity, so the use of components of different types, leaving the system less severely affected by possible common-cause failures. This basic idea also has applications to reliability of software-based systems, where redundancy with diversity can for example be achieved for a safety protection system by using multiple diverse channels performing the same function [41].

In this chapter, we restrict terminology to the basic situation of simple voting systems, so  $k$ -out-of- $m$  systems in which at least  $k$  components must function in



order for the system to function, and with the system consisting of components which all perform the same function. One can think for example about batteries or smoke detectors as components in a system. We now consider the possibility that the components are of different types, for example batteries or smoke detectors from different manufacturers, and that our information about the reliability of the components results from tests performed on such components.

We do not consider common-cause failures, but we focus on a perhaps even more important reason for aiming at diversity of components, which appears to have received little attention in the literature, namely the lack of perfect knowledge about the reliability of the components. This limited information about component reliability causes the random functioning of multiple components of one type in a system to be mutually dependent in the sense that functioning or not of one component in the system would change our total information on components of this type sufficiently to affect our beliefs on reliability of another component of this type in the system. As shown by Coolen-Schrijner *et al.* [29], this may well result in higher risk than may be expected without careful consideration of the uncertainties involved.

However, a possibly more important reason for diversity is illustrated here, namely the lack of perfect knowledge about the reliability of the components.

The system considered in this chapter is presented in Section 4.2. Subsection 4.2.1 provides a brief description of the system. In Subsection 4.2.2 the NPI lower and upper probabilities for functioning of a voting system with any number of component types are presented. The derivation of these NPI lower and upper probabilities is presented in Subsection 4.2.3. The optimal allocation of extra components is discussed in subsection 4.2.4. Section 4.3 presents examples to illustrate these lower and upper probabilities and to discuss some specific related features including diversity. Section 4.4 contains some concluding remarks.

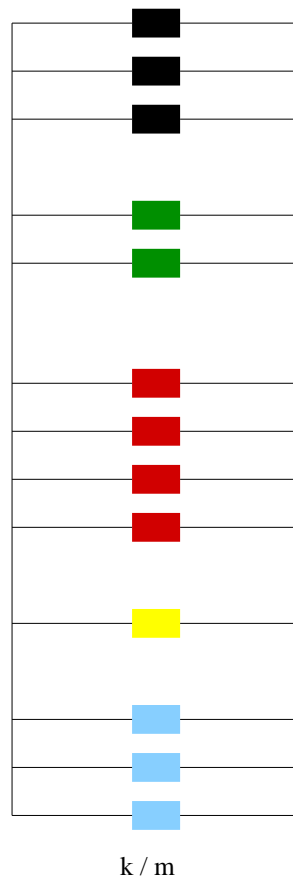

Figure 4.1: Voting systems with multiple component types

## 4.2 Multiple component types

### 4.2.1 System description

Consider a single voting system consisting of different types of components. They are assumed to perform the same function within the system, but the test information differs per type of component. Throughout this chapter we assume that functioning of components of different types is fully independent, in the sense that any information on functioning of components of one type does not hold any information about functioning of components of another type. Suppose that there are  $T$  types of components and the voting system consists of  $m_t$  components of type  $t$  for each  $t = 1, \dots, T$ , so  $m = m_1 + \dots + m_T$  components in total (see Figure 4.1).

This system functions if and only if at least  $k$  of its  $m$  components function, whatever their types. To apply the NPI approach for the reliability of this system,

assume that  $n_t$  components of type  $t$  have been tested of which  $s_t$  functioned. As before, the tested components are assumed to be exchangeable with those of the same type in the system. To denote the total test data for the  $t$  types we use the obvious notation  $(\underline{n}, \underline{s})$  and we denote the event that such a  $k$ -out-of- $m$  voting system functions successfully by  $S_{[T]}(m : k)$ . It is possible that  $m_t = 0$  for some  $t \in \{1, \dots, T\}$ , inclusion of such a component type which is not actually present in the system does not affect the results presented below and is also unlikely to lead to confusion in notation. We wish to derive the NPI lower and upper probabilities

$$\underline{P}(S_{[T]}(m : k) \mid (\underline{n}, \underline{s})) \text{ and } \overline{P}(S_{[T]}(m : k) \mid (\underline{n}, \underline{s})).$$

### 4.2.2 NPI lower and upper probabilities for functioning of the system

For a voting system consisting of  $T$  types of components, the NPI lower and upper probabilities for such a system to function are

$$\begin{aligned} \underline{P}(S_{[\tau]}(m : k) \mid (\underline{n}, \underline{s})) &= \underline{P}(S_{[\tau] \setminus r}(m : k) \mid (\underline{n}, \underline{s})) + \\ &\sum_{j=1}^{m_r} \underline{P}(S(m_r : j) \mid (n_r, s_r)) \Delta \underline{P}(S_{[\tau] \setminus r}(m : k - j) \mid (\underline{n}, \underline{s})) \end{aligned} \quad (4.1)$$

and

$$\begin{aligned} \overline{P}(S_{[\tau]}(m : k) \mid (\underline{n}, \underline{s})) &= \overline{P}(S_{[\tau] \setminus r}(m : k) \mid (\underline{n}, \underline{s})) + \\ &\sum_{j=1}^{m_r} \overline{P}(S(m_r : j) \mid (n_r, s_r)) \Delta \overline{P}(S_{[\tau] \setminus r}(m : k - j) \mid (\underline{n}, \underline{s})) \end{aligned} \quad (4.2)$$

respectively, where

$$\begin{aligned} \Delta \underline{P}(S_{[\tau] \setminus r}(m : l) \mid (\underline{n}, \underline{s})) &= \underline{P}(S_{[\tau] \setminus r}(m : l) \mid (\underline{n}, \underline{s})) - \underline{P}(S_{[\tau] \setminus r}(m : l + 1) \mid (\underline{n}, \underline{s})) \\ \Delta \overline{P}(S_{[\tau] \setminus r}(m : l) \mid (\underline{n}, \underline{s})) &= \overline{P}(S_{[\tau] \setminus r}(m : l) \mid (\underline{n}, \underline{s})) - \overline{P}(S_{[\tau] \setminus r}(m : l + 1) \mid (\underline{n}, \underline{s})) \end{aligned}$$

with  $[\tau] = \{1, \dots, \tau\}$  for  $\tau \leq T$  and  $[\tau] \setminus r = \{1, \dots, r - 1, r + 1, \dots, \tau\}$  for  $r < \tau$ .

For example, consider a single voting system consisting of two types of components ( $T = 2$ ). The NPI lower probability for this system to function is

$$\begin{aligned} & \underline{P}(S_{[2]}(m : k) \mid (\underline{n}, \underline{s})) \\ &= \underline{P}(S_{[2]\setminus 1}(m : k) \mid (\underline{n}, \underline{s})) + \sum_{j=1}^{m_1} \underline{P}(S(m_1 : j) \mid (n_1, s_1)) \Delta \underline{P}(S_{[2]\setminus 1}(m : k - j) \mid (\underline{n}, \underline{s})) \\ &= \underline{P}(S(m_2 : k) \mid (n_2, s_2)) + \sum_{j=1}^{m_1} \underline{P}(S(m_1 : j) \mid (n_1, s_1)) \Delta \underline{P}(S(m_2 : k - j) \mid (n_2, s_2)) \end{aligned}$$

where

$$\Delta \underline{P}(S(m_t : l) \mid (n_t, s_t)) = \underline{P}(S(m_t : l) \mid (n_t, s_t)) - \underline{P}(S(m_t : l + 1) \mid (n_t, s_t))$$

and

$$\underline{P}(S(m_t : k) \mid (n_t, s_t)) = \binom{n_t + m_t}{n_t}^{-1} \left[ \sum_{l=k}^{m_t} \binom{s_t + l - 1}{s_t - 1} \binom{n_t - s_t + m_t - l}{n_t - s_t} \right]$$

Alternatively, this NPI lower probability for system functioning can also be derived as

$$\begin{aligned} & \underline{P}(S_{[2]}(m : k) \mid (\underline{n}, \underline{s})) \\ &= \underline{P}(S_{[2]\setminus 2}(m : k) \mid (\underline{n}, \underline{s})) + \sum_{j=1}^{m_2} \underline{P}(S(m_2 : j) \mid (n_2, s_2)) \Delta \underline{P}(S_{[2]\setminus 2}(m : k - j) \mid (\underline{n}, \underline{s})) \\ &= \underline{P}(S(m_1 : k) \mid (n_1, s_1)) + \sum_{j=1}^{m_2} \underline{P}(S(m_2 : j) \mid (n_2, s_2)) \Delta \underline{P}(S(m_1 : k - j) \mid (n_1, s_1)) \end{aligned}$$

These two expressions for the NPI lower probability are easily shown to be equal.

The corresponding NPI upper probability is

$$\begin{aligned} & \overline{P}(S_{[2]}(m : k) \mid (\underline{n}, \underline{s})) \\ &= \overline{P}(S_{[2]\setminus 1}(m : k) \mid (\underline{n}, \underline{s})) + \sum_{j=1}^{m_1} \overline{P}(S(m_1 : j) \mid (n_1, s_1)) \Delta \overline{P}(S_{[2]\setminus 1}(m : k - j) \mid (\underline{n}, \underline{s})) \\ &= \overline{P}(S(m_2 : k) \mid (n_2, s_2)) + \sum_{j=1}^{m_1} \overline{P}(S(m_1 : j) \mid (n_1, s_1)) \Delta \overline{P}(S(m_2 : k - j) \mid (n_2, s_2)) \end{aligned}$$

where

$$\Delta \overline{P}(S(m_t : l) \mid (n_t, s_t)) = \overline{P}(S(m_t : l) \mid (n_t, s_t)) - \overline{P}(S(m_t : l + 1) \mid (n_t, s_t))$$

and

$$\begin{aligned} \bar{P}(S(m_t : k) \mid (n_t, s_t)) &= \binom{n_t + m_t}{n_t}^{-1} \left[ \binom{s_t + k}{s_t} \binom{n_t - s_t + m_t - k}{n_t - s_t} \right. \\ &\quad \left. + \sum_{l=k+1}^{m_t} \binom{s_t + l - 1}{s_t - 1} \binom{n_t - s_t + m_t - l}{n_t - s_t} \right] \end{aligned}$$

and it can also be derived as

$$\begin{aligned} &\bar{P}(S_{[2]}(m : k) \mid (\underline{n}, \underline{s})) \\ &= \bar{P}(S_{[2] \setminus 2}(m : k) \mid (\underline{n}, \underline{s})) + \sum_{j=1}^{m_2} \bar{P}(S(m_2 : j) \mid (n_2, s_2)) \Delta \bar{P}(S_{[2] \setminus 2}(m : k - j) \mid (\underline{n}, \underline{s})) \\ &= \bar{P}(S(m_1 : k) \mid (n_1, s_1)) + \sum_{j=1}^{m_2} \bar{P}(S(m_2 : j) \mid (n_2, s_2)) \Delta \bar{P}(S(m_1 : k - j) \mid (n_1, s_1)) \end{aligned}$$

In the next subsection the derivation of these NPI lower and upper probabilities will be presented in detail.

### 4.2.3 Derivation of the NPI lower and upper probabilities for functioning of the system

The NPI lower and upper probabilities (4.1) and (4.2) are derived by considering all combinations representing successful functioning of the system, using the theorem of total probability for classical probabilities as shown in Lemma 4.1 (below) for general  $T$ . The key aspect is that the theorem of total probability is used for all precise probability distributions in the NPI-based structure  $\mathcal{M}$  (as discussed in Section 1.1), and that sharp lower and upper bounds are derived.

Before we proceed, we introduce further notation. Let  $X_t$  denote the number of the  $m_t$  components of type  $t$  which function and write

$$c_t(j) = P(X_t \geq j), \quad u_t(j) = \bar{P}(X_t \geq j), \quad \ell_t(j) = \underline{P}(X_t \geq j).$$

Furthermore, for any set  $S \subset \{1, \dots, T\}$ , let

$$c_S(j) = P\left(\sum_{t \in S} X_t \geq j\right), \quad \Delta c_t(j) = c_t(j) - c_t(j+1)$$

$$\text{and } \Delta c_S(j) = c_S(j) - c_S(j+1)$$

with boundary conditions:

$$c_t(j) = c_S(j) = 1 \quad \text{for } j \leq 0,$$

$$c_t(j) = 0 \quad \text{for } j > m_t,$$

$$c_S(j) = 0 \quad \text{for } j > \sum_{t \in S} m_t,$$

$$\Delta c_t(j) = \Delta c_S(j) = 0 \quad \text{for } j < 0.$$

The notation stated above for classical probabilities  $c$  is also used below for upper and lower probabilities, replacing  $c$  by  $u$  or  $l$ , respectively.

**Lemma 4.1.** *Suppose  $X_1, \dots, X_T$ , with  $X_t \in \{0, 1, \dots, m_t\}$  for  $t \in \{1, \dots, T\}$ , are independent random quantities. For each  $\tau \in \{2, \dots, T\}$  and  $1 \leq r < \tau$ ,*

$$u_{[\tau]}(k) = u_{[\tau] \setminus r}(k) + \sum_{j=1}^{m_r} u_r(j) \Delta u_{[\tau] \setminus r}(k-j) \quad (4.3)$$

$$l_{[\tau]}(k) = l_{[\tau] \setminus r}(k) + \sum_{j=1}^{m_r} l_r(j) \Delta l_{[\tau] \setminus r}(k-j) \quad (4.4)$$

*Proof.* We provide the proof for upper probabilities, the proof for lower probabilities is identical with  $u$  replaced by  $l$  everywhere. We present the argument for  $T = 2$  types of components first and then generalize to  $T > 2$ . For  $T = 2$ ,  $X_1$  and  $X_2$  are independent so

$$P(X_1 + X_2 \geq k) = \sum_{j=0}^{m_1} P(X_1 = j) P(X_2 \geq k-j) \quad (4.5)$$

and, using the introduced notation, this gives

$$c_{[2]}(k) = \sum_{j=0}^{m_1} \Delta c_1(j) c_2(k-j) \leq \sum_{j=0}^{m_1} \Delta c_1(j) u_2(k-j)$$

as each  $\Delta c_1(j) \geq 0$ . Also

$$\begin{aligned} \sum_{j=0}^{m_1} \Delta c_1(j) u_2(k-j) &= c_1(0) u_2(k) + \sum_{j=1}^{m_1} c_1(j) \Delta u_2(k-j) \\ &\leq u_1(0) u_2(k) + \sum_{j=1}^{m_1} u_1(j) \Delta u_2(k-j) \end{aligned}$$

as each  $\Delta u_2(k-j) \geq 0$ , so

$$c_{[2]}(k) \leq u_1(0) u_2(k) + \sum_{j=1}^{m_1} u_1(j) \Delta u_2(k-j). \quad (4.6)$$

As equality in (4.6) is actually possible with  $c_2(j) = u_2(j)$  and  $c_1(j) = u_1(j)$  for each  $j$ , the upper probability  $u_{[2]}(k)$ , which is the minimum upper bound for  $c_{[2]}(k)$ ,

is

$$u_{[2]}(k) = u_2(k) + \sum_{j=1}^{m_1} u_1(j) \Delta u_2(k-j).$$

Now we consider  $T > 2$  and any  $\tau \in \{2, \dots, T\}$ . As  $X_1, \dots, X_T$  are independent we have, for  $r < \tau$ ,

$$c_{[\tau]}(k) = \sum_{j=0}^{m_r} \Delta c_r(j) c_{[\tau] \setminus r}(k-j) \leq \sum_{j=0}^{m_r} \Delta c_r(j) u_{[\tau] \setminus r}(k-j)$$

Using precisely the same arguments as for the case with  $T = 2$ , we get

$$u_{[\tau]}(k) = u_{[\tau] \setminus r}(k) + \sum_{j=1}^{m_r} u_r(j) \Delta u_{[\tau] \setminus r}(k-j).$$

□

Lemma 4.1 provides a recursive algorithm for calculation of the lower and upper probabilities for system functioning. It does not provide attractive expressions for analytical study of such lower and upper probabilities. It is straightforward to implement the recursive calculations. We have done this using the statistical software *R* and as all sums are finite there are no computational problems in computing these NPI lower and upper probabilities. For example, we computed NPI lower and upper probabilities for system with in total  $m = 20$  components of three possible types without any computational difficulties in terms of computational time. We have not considered computational efficiency in detail, for application of our results to large systems this may be an interesting topics for future research.

#### 4.2.4 Redundancy allocation

Voting systems, as considered in this chapter, are particularly important in situations where high reliability is required, as they offer the opportunity of redundancy, that is not all components have to function for the system to function, with maximum redundancy occurring for parallel systems. The results presented in this chapter enable study of optimal choice of components in the system, which is particularly interesting if the required number  $k$  of components that must function is fixed but one has flexibility in the choice of  $m$ . Such redundancy allocation was studied in

Chapter 2 for systems consisting of voting subsystems, where each subsystem has a single type of components which are different from those in other subsystems. It is also of interest to study optimal redundancy allocation for voting systems with different types of components as presented here. While no general optimality results have been proven yet, there is a strong feeling that making sequentially the optimal choices for adding single components leads to the overall optimal allocation of multiple extra components. This is in line with the results in Chapter 2, and all numerical examples studied suggest that it also holds for the systems considered here.

For the special case of parallel systems, so with  $k = 1$  and  $m_t$  components of type  $t$  ( $t = 1, \dots, T$ ), optimal allocation of extra components is straightforward if one aims at maximum NPI lower probability for the event that the system functions. This lower probability is

$$\underline{P}(S_T(m : 1) \mid (\underline{n}, \underline{s})) = 1 - \prod_{t=1}^T \prod_{j_t=1}^{m_t} \frac{n_t - s_t + j_t}{n_t + j_t}$$

where the product term on the right-hand side is the NPI upper probability for the event that the parallel system does not function, which occurs if and only if all its components fail. Adding one more component of type  $t_0$  leads to decrease of this upper probability by a factor  $\frac{n_{t_0} - s_{t_0} + m_{t_0} + 1}{n_{t_0} + m_{t_0} + 1}$ , so it is optimal to assign one more component of the type for which this factor is minimal, and the simple product form of this upper probability implies that optimal allocation of multiple extra components can be achieved by optimal sequential allocation of single components.

Actually, if one would allow a large enough number of extra components in such a parallel system, then eventually one would add one or more components of each type, even if test results for one type were very poor compared to the other types (assuming, as we do throughout this chapter, that there is at least one successfully functioning component of each type in the test). Suppose that type  $t_0 \in \{1, \dots, T\}$  has led to the poorest test results (lowest ratio  $s_t/n_t$ ) and that there are already  $m_{t_0}$  components of this type in the system. Then  $t_0$  is still the best component type to add to the system once there are already  $m_t$  components of type  $t$ , for each  $t \in \{1, \dots, T\}$ ,  $t \neq t_0$ , with  $m_t > (n_{t_0} + m_{t_0} + 1)(s_t/s_{t_0}) - n_t - 1$ . This result follows



straightforwardly from the above argument on sequential minimisation of the upper probability for the event that the parallel system does not function, and is illustrated in Example 4.3 in Section 4.3. We have not achieved a proof of a similar result for other voting systems, but numerical results suggest that it holds for all such systems with fixed value of  $k$  if  $m$  can be increased.

### 4.3 Examples

In this section we illustrate the NPI lower and upper probabilities presented in Subsection 4.2.2. In Example 4.1 we focus on the optimal choice of the number of components of each type in a  $k$ -out-of-20 system with 2 types of components, with optimality in the sense of maximum NPI lower probability of system functioning. It is natural to consider the lower probability for reliability inferences, as it reflects the strength of the evidence in favour of the system's reliability, and as such could be interpreted as a conservative inference. In Example 4.2 we consider a system with 3 types of components. Example 4.3 includes a brief discussion of the important topics of redundancy and diversity.

#### Example 4.1

Consider a voting system with in total  $m = 20$  components of two possible types, of which at least  $k$  must function in order for the system to function. Table 4.1 presents the optimal choices of  $m_1$  and  $m_2$ , the numbers of components of each type, for several test histories of components of types 1 and 2. All possible values for  $k$  ranging from 1 (parallel system) to 20 (series system) are considered. The notation  $(x, y)_p$  is used to indicate that all permutations of  $x, y$  are optimal.

If only one component of each type has been tested, and both functioned well, then it is optimal to use 10 components of each type if  $k \leq 10$ , but for  $k > 10$  it is optimal to use only one type of component. This is a direct consequence of the way in which the interdependence of the reliability of individual components of one type is taken into account. Let us consider the two extreme cases with  $k = 1$  and  $k = 20$ . For  $k = 1$  with test history  $(n_t, s_t) = (1, 1)$  for  $t = 1, 2$ , the lower probability for the first component of type 1 in the system to function is  $1/2$ . If this first component

$n, s$	$k$	$(m_1, m_2)$
$n_1 = n_2 = 1$	$\leq 10$	(10, 10)
$s_1 = s_2 = 1$	$\geq 11$	(20, 0) $p$
$n_1 = n_2 = 3$	$\leq 13$	(10, 10)
$s_1 = s_2 = 3$	14	(14, 6) $p$
	15	(18, 2) $p$
	$\geq 16$	(20, 0) $p$
$n_1 = n_2 = 5$	$\leq 15$	(10, 10)
$s_1 = s_2 = 5$	16	(15, 5) $p$
	$\geq 17$	(20, 0) $p$
$n_1 = n_2 = 3$	$\leq 10$	(10, 10)
$s_1 = 2, s_2 = 2$	$\geq 11$	(20, 0) $p$
$n_1 = n_2 = 3$	$\leq 4$	(7, 13)
$s_1 = 2, s_2 = 3$	5	(7, 13), (6, 14)
	6	(6, 14)
	7	(6, 14), (5, 15)
	8	(4, 16)
	9	(2, 18)
	$\geq 10$	(0, 20)

Table 4.1: Optimal  $m_1$  and  $m_2$  - Example 4.1

functions, the system functions whatever the reliability of all other components. If it does not function then we must consider the second component in the system. If the second component we consider is again of type 1, then the information that the first component of type 1 in the system failed reduces the lower probability for the second one to function to  $1/3$ , while the corresponding lower probability for a first component of type 2 is  $1/2$  (due to the assumed independence of reliability of components of different types). Hence, it would be better to consider as second component one of type 2.

This argument continues and leads, with the symmetrical test results, to  $m_1 = m_2 = 10$  as optimal choice for components of both types. This illustrates the benefit of diversity of components within a system. It has been argued that diversity is

important to prevent the possible effect of common-cause failures for components of one type, which is of course true but is not addressed in this chapter. However, a possibly more important reason for diversity is illustrated here, namely the lack of perfect knowledge about the reliability of the components.

For a series system all  $k = 20$  components must function. Hence, if the first one considered is of type 1 and does not function, we do not need to look further as the system would not function whatever the reliability of all other 19 components. If the first component (of type 1) functions then it is better for the second component also to be of type 1 as now it will have lower probability  $2/3$  to function, based on the test result and the information we now have on the first component of type 1, compared to lower probability  $1/2$  for a component of type 2. This argument now extends to all 20 components, leading to the optimal series system consisting of components of a single type. In fact, this argument holds for all series systems, not only those with symmetric test information. As illustrated by the last case in Table 4.1, if components of one type performed better in the test than components of the other type then the optimal choice is to use all components of the type which performed best in the test. The last case in Table 4.1, in which testing 3 components of type 1 led to one failure with no failures in testing of 3 components of type 2, shows that one would still include components of type 1 in the ‘more parallel’ systems considered ( $k \leq 9$ ). Again, this is logical from the perspective of diversity.

Table 4.1 further shows that the transition, when considered as function of  $k$ , of the optimal  $(m_1, m_2)$  from them being equal to the other extreme with one being equal to 20 and the other equal to 0, does not occur immediately in all situations. For example, if 3 components of each type were tested and no failures had been observed, then  $m_1 = m_2 = 10$  is optimal for all  $k \leq 13$ , and for  $k \geq 16$  it is optimal to only use components of one type in the system. However, for  $k = 14$  or  $15$  it is optimal to use different positive values for  $m_1$  and  $m_2$ .

### Example 4.2

This example considers a voting system with in total  $m = 6$  components of three different types. The optimal choices of  $m_1$ ,  $m_2$  and  $m_3$ , and the corresponding

	$k$	$(m_1, m_2, m_3)$	$\underline{P}$
A	1	(2, 2, 2)	0.995
	2	(2, 2, 2)	0.968
	3	(2, 2, 2)	0.870
	4	(2, 2, 2)	0.667
	5	(6, 0, 0) $p$	0.464
	6	(6, 0, 0) $p$	0.250
B	1	(3, 3, 0)	0.990
	2	(3, 3, 0)	0.950
	3	(3, 3, 0)	0.850
	4	(4, 2, 0), (2, 4, 0)	0.656
	5	(6, 0, 0), (0, 6, 0)	0.464
	6	(6, 0, 0), (0, 6, 0)	0.250
C	1	(3, 0, 3)	0.982
	2	(3, 0, 3), (4, 0, 2)	0.914
	3	(5, 0, 1), (6, 0, 0)	0.786
	4	(6, 0, 0)	0.643
	5	(6, 0, 0)	0.464
	6	(6, 0, 0)	0.250

Table 4.2: Optimal  $(m_1, m_2, m_3)$  and NPI lower probability - Example 4.2

NPI lower probabilities, are presented in Table 4.2 .

Three different cases of test results on components of each type are considered:

- A.  $n_1 = n_2 = n_3 = 2, s_1 = s_2 = s_3 = 2$
- B.  $n_1 = n_2 = n_3 = 2, s_1 = s_2 = 2, s_3 = 1$
- C.  $n_1 = n_2 = 2, n_3 = 5, s_1 = 2, s_2 = 1, s_3 = 3.$

All possible values for  $k$  ranging from 1 (parallel system) to 6 (series system) are considered. For completeness, Table 4.2 also presents the corresponding NPI lower probabilities of system functioning (denoted by  $\underline{P}$ ). These are, of course, decreasing as function of  $k$ , and increasing as function of the quality of the components tested.

As discussed in Example 4.1, for a series system ( $k = 6$ ) one again chooses components of a single type. Furthermore, cases B and C illustrate that for a series system, if components of one type performed better in the test than components of the other types, one obviously chooses the type of component which performed best in the test. For a parallel system ( $k = 1$ ), case C shows that although components of type 3 did not perform best in the test (namely 3 out of 5 tested were successful, while both type 1 components tested functioned well), one still chooses components of that type to achieve maximal lower probability of system functioning.

### Example 4.3

Consider a parallel system consisting of components of  $T = 3$  types. Initially, the system is a 1-out-of-3 system, with  $m_1 = m_2 = m_3 = 1$ . Assume that three components of each type had been tested, so  $n_1 = n_2 = n_3 = 3$ . Assume that all tested components of type 1 functioned, so  $s_1 = 3$ , but only two of type 2 and one of type 3 functioned, so  $s_2 = 2$  and  $s_3 = 1$ . The NPI lower probability for the event that this system functions successfully is equal to 0.90625. Suppose that, to increase the system's reliability by increasing redundancy, extra components can be added to the system, keeping  $k = 1$  but increasing the values of some or all of the  $m_t$  for  $t = 1, 2, 3$ . It is assumed that there are no cost considerations, only the number of extra components that can be added is restricted, and these extra components can be of any type. Table 4.3 presents the optimal allocation of 1 to 20 extra components ('Extra' in the first column), in the sense of maximum resulting

Extra	$(m_1, m_2, m_3)$	$\underline{P}$
0	(1,1,1)	0.90625
1	(2,1,1)	0.96250
2	(3,1,1)	0.98125
3	(4,1,1)	0.98925
4	(4,2,1)	0.99357
5	(5,2,1)	0.99598
6	(6,2,1)	0.99732
7	(6,3,1)	0.99821
8	(7,3,1)	0.99875
9	(7,4,1)	0.99912
10	(8,4,1)	0.99935
11	(9,4,1)	0.99951
12	(9,5,1)	0.99963
13	(10,5,1)	0.99972
14	(10,6,1)	0.99978
15	(10,7,1)	0.99983
16	(11,7,1)	0.99986
17	(12,7,1)	0.99989
18	(12,7,2)	0.99991
19	(13,7,2)	0.99993
20	(13,8,2)	0.99994

Table 4.3: Optimal allocation of extra components from Example 4.3. The red entries are used to indicate the type of extra component chosen at the specific stage.

NPI lower probability for the event that the system functions (denoted by  $\underline{P}$  in the last column).

If one extra component is allowed, it is optimal to add a component of type 1. This is fully as expected, since type  $A$  components seem to be more reliable than type 2 and type 3 components based on the test results. If two further extra components are allowed, all three would be chosen of type 1. However, if four extra components are allowed, it is optimal to take the fourth one to be of type 2. For up to 17 extra components they are all either of type 1 or 2 as presented in Table 4.3. If an eighteenth extra component is allowed, then it would be optimal to choose a component of type 3. This illustrates the result presented at the end of Subsection 4.2.3, in particular that it is better to add a component of type 3 than of type 1 if  $m_1 > 11$ , and better to add a component of type 3 than of type 2 if  $m_2 > 6$ , so indeed once  $m_1 \geq 12$  and  $m_2 \geq 7$  the first extra component of type 3 is chosen.

This illustrates an important aspect of NPI for system reliability. NPI takes explicitly into account that the reliabilities of components of one type in the system are statistically dependent, as a result of the limited information from the test data. Effectively, if one has the system with already 3 extra components added in the optimal manner, it has become quite a reliable system. If, however, this system does not function, it implies that the components of type 1 seem to be less reliable than had been expected based on the test results. Hence, at this point a component of type 2 would seem more reliable, based on the test results and the three assumedly failing extra components of type 1 in the system. This effect continues similarly, with each additional component the overall system reliability of course increases but the consideration of which further extra component to add is based on the situation where all current system components fail, as that is the only scenario for a parallel system not to function.

This example illustrates that diversity in redundancy allocation can result directly from maximisation of reliability, and is due to the limited knowledge about the reliability of the components of different types. This is an important reason for diversity that is different to the usually mentioned possibility of common-cause failures which would lead to all components of one type to fail. This example also

illustrates that sequential one-step-at-a-time optimisation leads to the same optimal allocation of extra components as overall optimisation. For parallel systems as considered here, this result was easily shown to hold as discussed at the end of Subsection 4.2.4.

## 4.4 Concluding remarks

This chapter presents another important step in the development of NPI for system reliability as, due to the use of lower and upper probabilities, it is non-trivial to deal with multiple component types in a single voting system. The natural next step is consideration of systems in series structure where each subsystem is a voting system with multiple types of components and with components of the same type appearing in different subsystems. This is the main topic of Chapter 5.

In Subsection 4.2.4 we briefly formulated a conjecture on redundancy allocation, in line with the results in Chapter 2. The basic idea of optimally allocating one more component, if one can increase  $m$  by one without changing  $k$ , is pretty straightforward, as one would just calculate the NPI lower probabilities corresponding to the possibility to add a component for each of the  $T$  component types, and then choose the type leading to maximum improvement. However, if one can allocate more than one component, it is not clear that one can proceed with such one-step-at-a-time optimisation, which would lead to a simple algorithm. We strongly feel that such an algorithm would be optimal, as was the case for the more basic scenarios we considered before, but we have not yet achieved a mathematical proof of optimality for systems with  $k \geq 2$ , for parallel systems ( $k = 1$ ) the result follows easily as discussed in Subsection 4.2.4, along the same lines as briefly explained in Section 2.5. A further research challenge is optimal redundancy allocation under cost constraints. We believe that for quite a large variety of cost structures the resulting problems can be formulated as standard optimisation problems, but this is left as a topic for future research.

The main lesson of this chapter is that considering diversity of components in a system is important to achieve maximum system reliability in situations with limited



information about component reliability, but the optimal configuration depends on the actual system structure, with diversity generally most useful for parallel systems, while for series systems one would not opt for diversity and only use components of the type that gave the best test results. We have only shown this for the simple systems considered in this chapter, but we strongly feel that similar conclusions will hold for more general system structures when NPI lower probabilities are used to express system reliability. Of course, if one feels that there may be common-cause failures that could simultaneously affect all components of one type in a system, as suggested as the main reason in favour of diversity in the literature (see Section 4.1), then diversity can have a positive effect on the system reliability which has not been considered in this chapter. In the NPI framework, common-cause failures can be considered, although one would require explicit test data on such failures in order to include it. One may also wish to consider different failure modes, Maturi *et al.* [44] recently presented NPI for competing risks data but did not explicitly link this to system reliability.

Finally, we wish to emphasize that the general idea to use diversity to optimize performance of a system in situations with uncertainty of performance of the system's components, as presented in this chapter with regard to reliability of voting systems, is common in many different areas of decision making under uncertainty. For example, decision makers in finance typically create diverse portfolios of investments due to uncertainty about performance of individual options, which is close in nature to the reason for diversity advocated in this chapter.

# Chapter 5

## Subsystems with multiple component types

### 5.1 Introduction

This chapter presents a generalization of results introduced in the previous three chapters by considering systems with a series structure, where each subsystem is a voting system with multiple types of components and with components of the same type appearing in different subsystems. As an example of systems where such a structure can occur one can think about anti-virus software for computer networks under possible global attack, with each computer system protected by a number of anti-virus programmes, some used at multiple computers with some further programmes possibly just used locally. The functioning of such programmes may be exchangeable but not ‘identical’ due to local aspects of the computers, for example how the software has been integrated into the system. Also, one may have tested the software for a variety of viruses, enabling a judgement of exchangeability on its performance against a further virus as long as one can assume that this virus was not created explicitly to circumvent specific anti-virus software.

Section 5.2 provides a brief description of the systems considered in this chapter. In Section 5.3 the NPI lower and upper probabilities for functioning of a system consisting of 2 subsystems with 2 component types are presented. In Section 5.4 the main results of this chapter are presented, namely the NPI lower and upper proba-

bilities for functioning of systems with a series structure where each subsystem is a voting system with multiple types of components. These results generalize the results in the previous chapters, and hence are the main results presented in this thesis. Section 5.5 presents examples to illustrate these lower and upper probabilities, and to discuss some specific related features including aspects of redundancy and diversity. Section 5.6 concludes the chapter with some remarks on further development of NPI for system reliability and related research challenges.

## 5.2 Subsystems with multiple component types

Consider a system consisting of  $L$  subsystems in a series configuration (see Figure 5.1). Each subsystem is a single voting system consisting of different types of components, which are assumed to perform the same function within the subsystem, but the test information differs per type of component. The important contribution of this chapter is that different subsystems can contain components of the same types. This is non-trivial, as the random quantities representing whether these components in the system function or not, are not independent in the NPI approach, given the test results. It is important that this dependence is explicitly taken into account, in particular when there is relatively little information from tests. Assume that functioning of components of different types is fully independent, in the sense that any information on functioning of components of one type does not hold any information about functioning of components of another type. Suppose that there are  $T$  types of components and the voting subsystem  $l$  ( $l = 1, \dots, L$ ) consists of  $m_t^l$  components of type  $t$  for each  $t = 1, \dots, T$ , so  $m^l = m_1^l + \dots + m_T^l$  and the whole system contains in total  $m^1 + \dots + m^L$  components. So, subsystem  $l$  functions if and only if at least  $k^l$  of its  $m^l$  components function, whatever their types, and the entire system functions if and only if all its  $L$  subsystems function.

To apply the NPI approach for the reliability of this system, assume that  $n_t$  components of type  $t$  have been tested, and  $s_t$  of these functioned. As before, the tested components are assumed to be exchangeable with those of the same type in the system. To denote the total test data for the  $t$  types the vector notation  $(\underline{n}, \underline{s})$

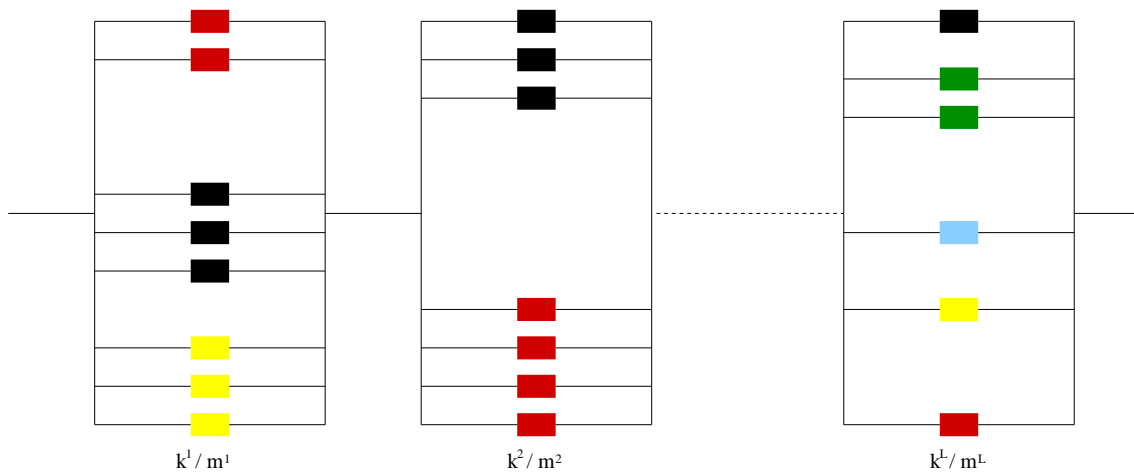

Figure 5.1: Subsystems with multiple component types

is used, and we use the obvious notation  $S_{[T]}^{[L]}(m^1 : k^1, \dots, m^L : k^L)$  to denote the event that such a system functions successfully. It is possible that  $m_t^l = 0$  for some  $t \in \{1, \dots, T\}$  and  $l \in \{1, \dots, L\}$ , inclusion of such a component type which is not actually present in the system does not affect the results presented below and is unlikely to lead to confusion in notation. Let  $X_t^l \in \{0, 1, \dots, m_t^l\}$  denote the number out of the  $m_t^l$  components of type  $t$  which function in subsystem  $l$ , for  $l \in \{1, \dots, L\}$  and  $t \in \{1, \dots, T\}$ . The aim is to derive the NPI lower and upper probabilities for the event that the system functions given the test data,

$$\underline{P}(S_{[T]}^{[L]}(m^1 : k^1, \dots, m^L : k^L) \mid (\underline{n}, \underline{s})) \quad (5.1)$$

and

$$\overline{P}(S_{[T]}^{[L]}(m^1 : k^1, \dots, m^L : k^L) \mid (\underline{n}, \underline{s})) \quad (5.2)$$

respectively.

Before presenting the general results for any number  $L$  of subsystems and  $T$  of component types, the case of a system consisting of  $L = 2$  subsystems with each subsystem consisting of the same  $T = 2$  types of components is considered in detail.

## 5.3 2 subsystems with 2 component types

Consider a system consisting of 2 subsystems with 2 component types. The NPI lower probability for the event that such a system functions is

$$\underline{P}(S_{[2]}^{[2]}(m^1 : k^1, m^2 : k^2) \mid (\underline{n}, \underline{s})) = \sum_{i^1=0}^{m_2^1} \sum_{i^2=0}^{m_2^2} \left[ \overline{D}(X_2^1 = i^1, X_2^2 = i^2 \mid n_2, s_2) \times \underline{P}(S_{[1]}^{[2]}(m_1^1 : k^1 - i^1, m_1^2 : k^2 - i^2 \mid n_1, s_1)) \right]$$

where

$$\begin{aligned} \overline{D}(X_2^1 = i^1, X_2^2 = i^2 \mid n_2, s_2) &= \\ \overline{P}(X_2^1 \leq i^1, X_2^2 \leq i^2 \mid n_2, s_2) &- \overline{P}(X_2^1 \leq i^1 - 1, X_2^2 \leq i^2 \mid n_2, s_2) \\ - \overline{P}(X_2^1 \leq i^1, X_2^2 \leq i^2 - 1 \mid n_2, s_2) &+ \overline{P}(X_2^1 \leq i^1 - 1, X_2^2 \leq i^2 - 1 \mid n_2, s_2) \end{aligned}$$

This NPI lower probability is derived by considering all combinations of numbers and types of components for the two subsystems according to which the system functions successfully, using the theorem of total probability for precise probabilities as shown in Theorem 5.1 below for general values of  $L$  and  $T$ . The function  $\overline{D}$  ensures that maximum possible weight (where ‘maximum’ is over all precise probability distributions in the NPI-based structure  $\mathcal{M}$  (see Chapter 1) is given to lower probabilities  $\underline{P}(S_{[1]}^{[2]}(m_1^1 : k^1 - i^1, m_1^2 : k^2 - i^2 \mid n_1, s_1))$  with small values of  $i^1$  and  $i^2$ , and as this lower probability is increasing in  $i^1$  and  $i^2$  this construction ensures that this  $\underline{P}(S_{[2]}^{[2]}(m^1 : k^1, m^2 : k^2))$  is the NPI lower probability for the event that this system functions. This function  $\overline{D}$  is such that it assigns the maximum possible probability mass, according to the NPI structure, to the event  $(X_2^1 = 0, X_2^2 = 0)$ , so  $\overline{D}(X_2^1 = 0, X_2^2 = 0 \mid n_2, s_2) = \overline{P}(X_2^1 = 0, X_2^2 = 0 \mid n_2, s_2)$ . Then,  $\overline{D}(X_2^1 = 1, X_2^2 = 0 \mid n_2, s_2)$  is defined by putting the maximum possible remaining probability mass from the total probability mass available for the event  $(X_2^1 \leq 1, X_2^2 = 0)$ , according to the NPI structure, to the event  $(X_2^1 = 1, X_2^2 = 0)$ . This is achieved by  $\overline{D}(X_2^1 = 1, X_2^2 = 0 \mid n_2, s_2) = \overline{P}(X_2^1 \leq 1, X_2^2 = 0 \mid n_2, s_2) - \overline{P}(X_2^1 = 0, X_2^2 = 0 \mid n_2, s_2)$ . Following similar reasoning, the maximum possible remaining probability mass  $\overline{D}(X_2^1 = 0, X_2^2 = 1 \mid n_2, s_2) = \overline{P}(X_2^1 = 0, X_2^2 \leq 1 \mid n_2, s_2) - \overline{P}(X_2^1 = 0, X_2^2 = 0 \mid n_2, s_2)$  is assigned to the event  $(X_2^1 = 0, X_2^2 = 1)$ . This

argument is continued, by assigning for increasing  $i^1$  and  $i^2$  the maximum possible remaining probability mass  $\overline{D}(X_2^1 = i^1, X_2^2 = i^2 \mid n_2, s_2)$ . By this construction, the resulting  $\overline{D}$  is actually a precise probability distribution within the NPI-based structure for the random quantities  $(X_2^1, X_2^2)$ . The use of the NPI lower probabilities  $\underline{P}(S_{[1]}^{[2]}(m_1^1 : k^1 - i^1, m_1^2 : k^2 - i^2 \mid n_1, s_1))$  to achieve the NPI lower probability  $\underline{P}(S_{[2]}^{[2]}(m^1 : k^1, m^2 : k^2) \mid (\underline{n}, \underline{s}))$  is straightforwardly seen to result from minimisation over the corresponding NPI-based structure for the random quantities  $(X_1^1, X_1^2)$ .

In the following section, this assignment of maximum remaining probability masses will be extended to the general case with  $L \geq 2$  subsystems and  $T \geq 2$  types of components in Theorem 5.1, the main ideas are the same as for this case with  $L = 2$  and  $T = 2$ . The NPI lower and upper probabilities needed to calculate  $\underline{P}(S_{[2]}^{[2]}(m^1 : k^1, m^2 : k^2) \mid (\underline{n}, \underline{s}))$  each involve only a single type of component, and hence are as presented in Chapter 3.

The corresponding NPI upper probability for such a system to function is

$$\overline{P}(S_{[2]}^{[2]}(m^1 : k^1, m^2 : k^2) \mid (\underline{n}, \underline{s})) = \sum_{i^1=0}^{m_2^1} \sum_{i^2=0}^{m_2^2} \left[ \underline{D}(X_2^1 = i^1, X_2^2 = i^2 \mid n_2, s_2) \times \overline{P}(S_{[1]}^{[2]}(m_1^1 : k^1 - i^1, m_1^2 : k^2 - i^2 \mid n_1, s_1)) \right]$$

where

$$\begin{aligned} \underline{D}(X_2^1 = i^1, X_2^2 = i^2 \mid n_2, s_2) = & \\ \underline{P}(X_2^1 \leq i^1, X_2^2 \leq i^2 \mid n_2, s_2) - \underline{P}(X_2^1 \leq i^1 - 1, X_2^2 \leq i^2 \mid n_2, s_2) & \\ - \underline{P}(X_2^1 \leq i^1, X_2^2 \leq i^2 - 1 \mid n_2, s_2) + \underline{P}(X_2^1 \leq i^1 - 1, X_2^2 \leq i^2 - 1 \mid n_2, s_2) & \end{aligned}$$

Justification of this result is similar to that for the NPI lower probability given above, with the obvious exchange of lower and upper probabilities.

## 5.4 $L$ subsystems with $T$ component types

For a system consisting of  $L$  subsystems with  $T$  component types, the NPI lower and upper probabilities for the system to function are

$$\begin{aligned}
\underline{P}(S_{[\tau]}^{[L]}(m^1 : k^1, \dots, m^L : k^L) \mid (\underline{n}, \underline{s})) &= \\
\sum_{i^1=0}^{m_\tau^1} \cdots \sum_{i^L=0}^{m_\tau^L} [\overline{D}_\tau(X_\tau^1 = i^1, \dots, X_\tau^L = i^L \mid n_\tau, s_\tau) \times \\
\underline{P}(S_{[\tau-1]}^{[L]}(m^1 : k^1 - i^1, \dots, m^L : k^L - i^L) \mid (\underline{n}, \underline{s}))] & \quad (5.3)
\end{aligned}$$

and

$$\begin{aligned}
\overline{P}(S_{[\tau]}^{[L]}(m^1 : k^1, \dots, m^L : k^L) \mid (\underline{n}, \underline{s})) &= \\
\sum_{i^1=0}^{m_\tau^1} \cdots \sum_{i^L=0}^{m_\tau^L} [\underline{D}_\tau(X_\tau^1 = i^1, \dots, X_\tau^L = i^L \mid n_\tau, s_\tau) \times \\
\overline{P}(S_{[\tau-1]}^{[L]}(m^1 : k^1 - i^1, \dots, m^L : k^L - i^L) \mid (\underline{n}, \underline{s}))] & \quad (5.4)
\end{aligned}$$

respectively, with  $[\tau] = \{1, \dots, \tau\}$  for  $\tau \leq T$ .

To derive the NPI lower and upper probabilities (5.3) and (5.4) for general  $L$  and  $T$  we introduce the following notation:

$$\begin{aligned}
u_t^L(i^1, i^2, \dots, i^L) &= \overline{P}(X_t^1 \geq i^1, X_t^2 \geq i^2, \dots, X_t^L \geq i^L \mid n_t, s_t) \\
\ell_t^L(i^1, i^2, \dots, i^L) &= \underline{P}(X_t^1 \geq i^1, X_t^2 \geq i^2, \dots, X_t^L \geq i^L \mid n_t, s_t) \\
c_t^L(i^1, i^2, \dots, i^L) &= P(X_t^1 \geq i^1, X_t^2 \geq i^2, \dots, X_t^L \geq i^L) \\
e_t^L(i^1, i^2, \dots, i^L) &= P(X_t^1 = i^1, X_t^2 = i^2, \dots, X_t^L = i^L)
\end{aligned}$$

Furthermore, for any set  $S \subset \{1, \dots, T\}$ , let

$$\begin{aligned}
u_S^L(i^1, i^2, \dots, i^L) &= \overline{P}\left(\sum_{t \in S} X_t^1 \geq i^1, \sum_{t \in S} X_t^2 \geq i^2, \dots, \sum_{t \in S} X_t^L \geq i^L \mid (\underline{n}, \underline{s})\right) \\
\ell_S^L(i^1, i^2, \dots, i^L) &= \underline{P}\left(\sum_{t \in S} X_t^1 \geq i^1, \sum_{t \in S} X_t^2 \geq i^2, \dots, \sum_{t \in S} X_t^L \geq i^L \mid (\underline{n}, \underline{s})\right) \\
c_S^L(i^1, i^2, \dots, i^L) &= P\left(\sum_{t \in S} X_t^1 \geq i^1, \sum_{t \in S} X_t^2 \geq i^2, \dots, \sum_{t \in S} X_t^L \geq i^L\right) \\
e_S^L(i^1, i^2, \dots, i^L) &= P\left(\sum_{t \in S} X_t^1 = i^1, \sum_{t \in S} X_t^2 = i^2, \dots, \sum_{t \in S} X_t^L = i^L\right)
\end{aligned}$$

and let  $[\tau] = \{1, \dots, \tau\}$  for  $\tau \leq T$ .

The lower and upper probabilities introduced above and used in Theorem 5.1 are explicitly assumed to be resulting from NPI, as emphasized by inclusion of the test data in the notation. Of course, of the data  $(\underline{n}, \underline{s})$  for all  $T$  types of components, only the  $(n_t, s_t)$  with  $t \in S$  are relevant for  $u_S^L$  and  $\ell_S^L$ . The main result of this chapter is presented in Theorem 5.1, and is a recursive relation that enables calculation of the NPI lower and upper probabilities for the event that a system of the kind considered in this chapter functions, given component test data. The main idea is that, with  $T$  different types of components in the system, at each stage (which is one application of the results of Theorem 5.1) one type of component is separated from the others and the theorem of total probability is used for the precise probabilities in the NPI-based structures to take all their possible values into account, leaving one fewer type of component to be dealt with at the next stage. The complexity of computations at each stage is based on the number of subsystems  $L$ , and the number of stages is based on the number of component types  $T$ . This explains why for large values of  $T$  and  $L$ , computational difficulties (in terms of computational time) are expected to appear. Theorem 5.1 presents the mathematical argument for one such a stage, with the notational simplification of assuming that the component types to be considered are the set  $[\tau]$ , of which the components of type  $\tau$  are separated from the others at the stage considered, hence leaving the components of types  $[\tau - 1]$  to be considered at the next stage. This can be done without loss of generality, as the specific types of the components are just labels that can be ordered in any way. An interesting topic for future research is the effect of specific orders on computational efficiency. For example it could be best to label the component types  $1, \dots, \tau$ , for any  $\tau \in \{1, \dots, T\}$ , in such an order that components of one of these types which appear in the largest number of subsystems are separated from the other component types first, hence are defined as being of type  $\tau$ .

Before Theorem 5.1 can be presented, one more concept is required, namely the generalization of the functions  $\underline{D}$  and  $\overline{D}$ , presented in Section 5.3 for the case  $L = 2$ , for application to systems with more than two subsystems. For components of type  $t \in \{1, \dots, T\}$  and  $L$  subsystems, let the function  $\overline{D}_t(X_t^1 = i^1, \dots, X_t^L = i^L \mid n_t, s_t)$  be the maximum possible remaining probability mass, corresponding to the NPI



structure, that can be assigned to the point  $(i^1, \dots, i^L)$  but not to any other point  $(a^1, \dots, a^L)$  with integers  $a^l \in \{0, \dots, i^l\}$ . Hence, for  $L = 2$  the function  $\bar{D}_2(X_2^1 = i^1, X_2^2 = i^2 \mid n_2, s_2)$  is equal to the function  $\bar{D}$  discussed above. Generally, this means that  $\bar{D}_t(X_t^1 = 0, \dots, X_t^L = 0 \mid n_t, s_t) = \bar{P}(X_t^1 = 0, \dots, X_t^L = 0 \mid n_t, s_t)$ , with further values derived as combinations of these upper cumulative joint distribution function values at  $(i^1, \dots, i^L)$  and at such points  $(a^1, \dots, a^L)$  with integers  $a^l \in \{0, \dots, i^l\}$ , ensuring that no probability mass is included more than once. For ease of notation, let

$$\bar{g}(i^1, i^2, \dots, i^L) = \bar{P}(X_t^1 \leq i^1, X_t^2 \leq i^2, \dots, X_t^L \leq i^L \mid n_t, s_t)$$

$$\bar{g}(i^1 - 1, i^2 - 1, \dots, i^L - 1) = \bar{P}(X_t^1 \leq i^1 - 1, X_t^2 \leq i^2 - 1, \dots, X_t^L \leq i^L - 1 \mid n_t, s_t)$$

$$\bar{g}_{j_1}(i^1, \dots, i^{j_1-1}, i^{j_1} - 1, i^{j_1+1}, \dots, i^L) =$$

$$\bar{P}(X_t^1 \leq i^1, \dots, X_t^{j_1} \leq i^{j_1} - 1, X_t^{j_1+1} \leq i^{j_1+1}, \dots, X_t^L \leq i^L \mid n_t, s_t)$$

$$\bar{g}_{j_1, \dots, j_h}(i^1, \dots, i^{j_1-1}, i^{j_1} - 1, \dots, i^{j_h} - 1, i^{j_h+1}, \dots, i^L) =$$

$$\bar{P}(X_t^1 \leq i^1, \dots, X_t^{j_1} \leq i^{j_1} - 1, \dots, X_t^{j_h} \leq i^{j_h} - 1, X_t^{j_h+1} \leq i^{j_h+1}, \dots, X_t^L \leq i^L \mid n_t, s_t)$$

where

$$1 \leq j_1 < j_2 < \dots < j_h \leq L$$

and

$$\bar{P}(X_t^1 \leq i^1, X_t^2 \leq i^2, \dots, X_t^L \leq i^L \mid n_t, s_t) =$$

$$\sum_{y^1=0}^{i^1} \dots \sum_{y^L=0}^{i^L} \bar{D}_t(X_t^1 = y^1, X_t^2 = y^2, \dots, X_t^L = y^L \mid n_t, s_t)$$

Using the notation introduced above and the inclusion-exclusion principle, we get

$$\begin{aligned}
& \sum_{y^1=0}^{i^1} \cdots \sum_{y^L=0}^{i^L} \overline{D}_t(X_t^1 = y^1, X_t^2 = y^2, \dots, X_t^L = y^L \mid n_t, s_t) = \\
& \overline{D}_t(X_t^1 = i^1, X_t^2 = i^2, \dots, X_t^L = i^L \mid n_t, s_t) + \left[ \sum_{j_1=1}^L \overline{g}_{j_1}(i^1, \dots, i^{j_1} - 1, i^{j_1+1}, \dots, i^L) \right. \\
& - \sum_{j_1, j_2: 1 \leq j_1 < j_2 \leq L} \overline{g}_{j_1, j_2}(i^1, \dots, i^{j_1} - 1, i^{j_2} - 1, i^{j_2+1}, \dots, i^L) \\
& + \sum_{j_1, j_2, j_3: 1 \leq j_1 < j_2 < j_3 \leq L} \overline{g}_{j_1, j_2, j_3}(i^1, \dots, i^{j_1} - 1, i^{j_2} - 1, i^{j_3} - 1, i^{j_3+1}, \dots, i^L) \\
& \left. - \cdots + (-1)^{L-1} \overline{g}(i^1 - 1, i^2 - 1, \dots, i^L - 1) \right]
\end{aligned}$$

so

$$\begin{aligned}
& \overline{D}_t(X_t^1 = i^1, X_t^2 = i^2, \dots, X_t^L = i^L \mid n_t, s_t) = \\
& \overline{g}(i^1, i^2, \dots, i^L) - \left[ \sum_{j_1=1}^L \overline{g}_{j_1}(i^1, \dots, i^{j_1} - 1, i^{j_1+1}, \dots, i^L) \right. \\
& - \sum_{j_1, j_2: 1 \leq j_1 < j_2 \leq L} \overline{g}_{j_1, j_2}(i^1, \dots, i^{j_1} - 1, i^{j_2} - 1, i^{j_2+1}, \dots, i^L) \\
& + \sum_{j_1, j_2, j_3: 1 \leq j_1 < j_2 < j_3 \leq L} \overline{g}_{j_1, j_2, j_3}(i^1, \dots, i^{j_1} - 1, i^{j_2} - 1, i^{j_3} - 1, i^{j_3+1}, \dots, i^L) \\
& \left. - \cdots + (-1)^{L-1} \overline{g}(i^1 - 1, i^2 - 1, \dots, i^L - 1) \right]
\end{aligned}$$

The NPI upper cumulative joint distribution functions involved follow directly from the results in Chapter 3. Similarly, the function  $\underline{D}_t(X_t^1 = i^1, \dots, X_t^L = i^L \mid n_t, s_t)$  gives the minimum possible remaining probability mass corresponding to the NPI structure, and takes the same functional form as  $\overline{D}_t$  but with all upper cumulative joint distribution functions replaced by the corresponding lower cumulative joint distribution functions.

**Theorem 5.1.** *Consider the random quantities  $X_t^l \in \{0, 1, \dots, m_t^l\}$  for  $t \in \{1, \dots, T\}$  and  $l \in \{1, \dots, L\}$  with  $X_t^l$  the number of functioning components of type  $t$  in subsystem  $l$ . These random quantities for different types  $t$  are assumed to be independent, while for the same type but for different subsystems they are assumed to be exchange-*

able. Let  $\tau \in \{2, \dots, T\}$  and  $\kappa^l \in \{0, 1, \dots, m_\tau^l\}$ , then

$$\begin{aligned} \ell_{[\tau]}^L(\kappa^1, \dots, \kappa^L) &= \\ \sum_{i^1=0}^{m_\tau^1} \cdots \sum_{i^L=0}^{m_\tau^L} \bar{D}_\tau(X_\tau^1 = i^1, \dots, X_\tau^L = i^L \mid n_\tau, s_\tau) \ell_{[\tau-1]}^L(\kappa^1 - i^1, \dots, \kappa^L - i^L) \end{aligned}$$

and

$$\begin{aligned} u_{[\tau]}^L(\kappa^1, \dots, \kappa^L) &= \\ \sum_{i^1=0}^{m_\tau^1} \cdots \sum_{i^L=0}^{m_\tau^L} \underline{D}_\tau(X_\tau^1 = i^1, \dots, X_\tau^L = i^L \mid n_\tau, s_\tau) u_{[\tau-1]}^L(\kappa^1 - i^1, \dots, \kappa^L - i^L) \end{aligned}$$

*Proof.* We prove the NPI lower probability, the justification for the corresponding upper probability follows the same steps (again with upper and lower probabilities exchanged everywhere). The proof is first given for  $L = 2$  subsystems and  $T = 2$  types of components. For this case, the key steps of the proof were already explained in Section 5.3, but it is useful to have the argument presented in the notation that allows generalization. For the case with  $L = 2$  and  $T = 2$ , the theorem of total probability gives, for any precise probability distribution  $P(\cdot)$  in the NPI-based structure,

$$\begin{aligned} P(X_1^1 + X_2^1 \geq \kappa^1, X_1^2 + X_2^2 \geq \kappa^2) &= \\ \sum_{i^1=0}^{m_1^1} \sum_{i^2=0}^{m_1^2} P(X_2^1 = i^1, X_2^2 = i^2) P(X_1^1 \geq \kappa^1 - i^1, X_1^2 \geq \kappa^2 - i^2) \end{aligned}$$

Using the notation introduced earlier in this section the following lower bound for such precise probabilities is derived

$$\begin{aligned} c_{[2]}^2(\kappa^1, \kappa^2) &= \sum_{i^1=0}^{m_2^1} \sum_{i^2=0}^{m_2^2} e_2^2(i^1, i^2) c_1^2(\kappa^1 - i^1, \kappa^2 - i^2) \\ &\geq \sum_{i^1=0}^{m_2^1} \sum_{i^2=0}^{m_2^2} e_2^2(i^1, i^2) \ell_1^2(\kappa^1 - i^1, \kappa^2 - i^2) \\ &\geq \sum_{i^1=0}^{m_2^1} \sum_{i^2=0}^{m_2^2} \bar{D}_2(X_2^1 = i^1, X_2^2 = i^2 \mid n_2, s_2) \ell_1^2(\kappa^1 - i^1, \kappa^2 - i^2) \end{aligned}$$

Justification of these inequalities has been discussed above, where it was also explained that these two inequalities are sharp, in the sense that for both equality can

be achieved for a specific probability distribution in the relevant NPI structure. So the right-hand side of the second inequality is the infimum over all precise probability distributions in this NPI structure, hence it is the NPI lower probability for the event of interest, so

$$\ell_2^2(\kappa^1, \kappa^2) = \sum_{i^1=0}^{m_2^1} \sum_{i^2=0}^{m_2^2} \overline{D}_2(X_2^1 = i^1, X_2^2 = i^2 \mid n_2, s_2) \ell_1^2(\kappa^1 - i^1, \kappa^2 - i^2)$$

For the general case with  $L \geq 2$  and  $T \geq 2$  and any  $\tau \in \{2, \dots, T\}$  the proof of Theorem 5.1 follows the same steps as for the case with  $L = 2$  and  $T = 2$ , the key aspect is again that the theorem of total probability is used for all precise probability distributions in the NPI-based structure, and that a sharp lower bound is derived. With the notation introduced above, and for general values of  $L$  and  $T$ ,

$$\begin{aligned} & c_{[\tau]}^L(\kappa^1, \dots, \kappa^L) \\ = & \sum_{i^1=0}^{m_\tau^1} \cdots \sum_{i^L=0}^{m_\tau^L} e_\tau^L(i^1, \dots, i^L) c_{[\tau-1]}^L(\kappa^1 - i^1, \dots, \kappa^L - i^L) \\ \geq & \sum_{i^1=0}^{m_\tau^1} \cdots \sum_{i^L=0}^{m_\tau^L} e_\tau^L(i^1, \dots, i^L) \ell_{[\tau-1]}^L(\kappa^1 - i^1, \dots, \kappa^L - i^L) \\ \geq & \sum_{i^1=0}^{m_\tau^1} \cdots \sum_{i^L=0}^{m_\tau^L} \overline{D}_\tau(X_\tau^1 = i^1, \dots, X_\tau^L = i^L \mid n_\tau, s_\tau) \ell_{[\tau-1]}^L(\kappa^1 - i^1, \dots, \kappa^L - i^L) \end{aligned}$$

The same arguments as for the case with  $L = 2$  and  $T = 2$ , given above in this proof and earlier in Section 5.3, ensure that this right-hand side is actually attainable for precise probability distributions within the NPI-based structures for the random quantities involved, and hence that it is the NPI lower probability for the event of interest,

$$\begin{aligned} & \ell_{[\tau]}^L(\kappa^1, \dots, \kappa^L) = \\ & \sum_{i^1=0}^{m_\tau^1} \cdots \sum_{i^L=0}^{m_\tau^L} \overline{D}_\tau(X_\tau^1 = i^1, \dots, X_\tau^L = i^L \mid n_\tau, s_\tau) \ell_{[\tau-1]}^L(\kappa^1 - i^1, \dots, \kappa^L - i^L) \end{aligned}$$

which completes the proof of Theorem 5.1.  $\square$

Theorem 5.1 provides a recursive algorithm for calculation of the NPI lower and upper probabilities for system functioning as considered in this chapter, where the

$n$	$s$	Sys1 $k = 21$		Sys2 $k^1 = 10$ $k^2 = 11$		Sys1 $k = 22$		Sys2 $k^1 = 11$ $k^2 = 11$		Sys1 $k = 24$		Sys2 $k^1 = 12$ $k^2 = 12$	
		$\underline{P}$	$\overline{P}$	$\underline{P}$	$\overline{P}$	$\underline{P}$	$\overline{P}$	$\underline{P}$	$\overline{P}$	$\underline{P}$	$\overline{P}$	$\underline{P}$	$\overline{P}$
1	1	0.059	1	0.041	1	0.036	1	0.027	1	0.006	1	0.006	1
2	2	0.173	1	0.123	1	0.110	1	0.086	1	0.020	1	0.020	1
3	3	0.294	1	0.214	1	0.196	1	0.155	1	0.040	1	0.040	1
	2	0.023	0.294	0.014	0.214	0.012	0.196	0.007	0.155	0.001	0.040	0.001	0.040
5	5	0.499	1	0.382	1	0.360	1	0.292	1	0.087	1	0.087	1
	4	0.110	0.499	0.070	0.382	0.057	0.360	0.040	0.292	0.005	0.087	0.005	0.087
10	10	0.783	1	0.650	1	0.640	1	0.547	1	0.207	1	0.207	1
	9	0.416	0.783	0.292	0.650	0.263	0.640	0.199	0.547	0.038	0.207	0.038	0.207
	8	0.160	0.416	0.099	0.292	0.079	0.263	0.055	0.199	0.006	0.038	0.006	0.038
20	20	0.944	1	0.855	1	0.862	1	0.783	1	0.391	1	0.391	1
24	24	0.964	1	0.890	1	0.900	1	0.829	1	0.444	1	0.444	1
30	30	0.980	1	0.923	1	0.935	1	0.876	1	0.510	1	0.510	1

Table 5.1: NPI lower and upper probabilities for the systems in Example 5.1

first step is achieved by setting  $\tau = T$  and  $(\kappa^1, \dots, \kappa^L) = (k^1, \dots, k^L)$ , and recursive application of Theorem 5.1 leads to these NPI lower and upper probabilities. As all summations involved are finite, there are no significant computational difficulties. However, for large values of  $T$  and  $L$ , computational difficulties are expected to appear due to the very large number of calculations involved. Unfortunately, these expressions do not enable detailed analytical study of these NPI lower and upper probabilities, so several examples are presented in Section 5.5 to illustrate these results and to discuss some important properties of these inferences.

## 5.5 Examples

This section presents two examples to illustrate the results presented in the previous section. The NPI lower and upper probabilities for successful functioning of a system consisting of 2 subsystems with 2 component types are discussed in the first example, including comparisons with a single voting system with 2 component types. The second example considers a system with 3 subsystems and 3 components, and includes a brief discussion of the important topics of redundancy and diversity.

### Example 5.1

Two different systems, each having components of  $T = 2$  types  $A$  and  $B$ , are considered. The first is a  $k$ -out-of-24 system with  $m_a = m_b = 12$ . The second consists of

$L = 2$   $k^i$ -out-of-12 subsystems in series configuration with  $m_a^1 = m_b^1 = m_a^2 = m_b^2 = 6$ . The NPI lower and upper probabilities for the event that a system functions successfully are presented in Table 5.1, for different test data and some different values of  $k$ ,  $k^1$  and  $k^2$ . The values in Table 5.1, for both systems, illustrate some of the general properties of NPI lower and upper probabilities for all  $k$ -out-of- $m$  systems. The NPI upper probability for successful system functioning given  $s$  successes in  $n$  tests is equal to the NPI lower probability for successful system functioning given  $s+1$  successes. The value 1 of the NPI upper probability if  $s = n$  reflects that in this case there is no strong evidence that the components can actually fail. If all components in the system must function, the reliability tends to be very small for cases where some components failed in the tests, which is logical as the test information only provides weak support for this event. The imprecision, that is the difference between corresponding NPI upper and lower probabilities, tends to decrease as a function of  $n$  and increase as a function of  $m$ , although the imprecision tends to become smaller for non-trivial events if both the upper and lower probabilities get close to either zero or to one. It is clear that the system reliability, as measured by these NPI lower and upper probabilities, increases substantially for decreasing  $k$  or  $k^1$  and  $k^2$  (except those equal to 1), so if fewer of the 24 components have to function, and also for increasing numbers of tested components if these were all successful.

For both these systems, the lower and upper probabilities in the two final columns are identical as in these cases the systems only function if all 24 components function. The other cases give different results due to the different system configurations. For example, a 22-out-of-24 system functions for more combinations of failing components than two 11-out-of-12 subsystems in a series configuration, the former system still functions for example if any two components fail while the latter system fails if the two failing components are in the same subsystem. This explains why the entries related to the first system (Sys1) are greater than those for the corresponding cases, with  $k^1 + k^2 = k$ , related to the second system (Sys2).

$i$	subsystem $i$	$m_a^i$	$m_b^i$	$m_c^i$
1	1-out-of-6	2	2	2
2	2-out-of-6	2	2	2
3	3-out-of-6	4	0	2

Table 5.2: 3 subsystems considered in Example 5.2

**Example 5.2**

Consider a system consisting of  $L = 3$  subsystems in series configuration with components of  $T = 3$  types,  $A$ ,  $B$  and  $C$ , as specified in Table 5.2.

Testing 3 components of each type,  $n_a = n_b = n_c = 3$ , led to  $s_a = 3$ ,  $s_b = 2$  and  $s_c = 1$  functioning components. The NPI lower probability for the event that this system functions is equal to 0.7256. Suppose that, to increase the system's reliability by increasing redundancy, extra components can be added to the system, keeping  $k^1 = 1$ ,  $k^2 = 2$  and  $k^3 = 3$  but increasing the values of some of the  $m_l^t$  for  $t = a, b, c$  and  $l = 1, 2, 3$ . It is assumed that there are no cost considerations, only the number of extra components that can be added is restricted, and these extra components can be of any type and added to any of the two subsystems.

It is natural here to consider the lower probability for reliability inferences, as it reflects the strength of the evidence in favour of the system's reliability, and as such could be interpreted as a conservative inference. Table 5.3 presents the optimal allocation of 1 to 20 extra components ('Extra' in the first column), in the sense of maximum resulting NPI lower probability for the event that the system functions ( $\underline{P}$  in the last column).

If one extra component is allowed, it is optimal to add a component of type  $A$  to subsystem 3. This is fully as expected, since type  $A$  components seem to be more reliable than type  $B$  and type  $C$  components based on the test results, and subsystem 3 has less redundancy in the original system than subsystems 1 and 2. With three extra components, it is optimal to have them all of type  $A$  with one added to subsystem 2 and two to subsystem 3. If then a further extra component is allowed, it is optimal to add one of type  $B$  to subsystem 3. For up to 20 extra components they are all either of type  $A$  or  $B$  as presented in Table 5.3. However, if more extra

Extra	$(m_a^1, m_b^1, m_c^1, m_a^2, m_b^2, m_c^2, m_a^3, m_b^3, m_c^3)$	$P$
0	(2,2,2,2,2,2,4,0,2)	0.7256
1	(2,2,2,2,2,2,5,0,2)	0.7896
2	(2,2,2,3,2,2,5,0,2)	0.8302
3	(2,2,2,3,2,2,6,0,2)	0.8675
4	(2,2,2,3,2,2,6,1,2)	0.8907
5	(2,2,2,4,2,2,6,1,2)	0.9087
6	(2,2,2,4,2,2,6,2,2)	0.9244
7	(2,2,2,4,2,2,7,2,2)	0.9345
8	(2,2,2,5,2,2,7,2,2)	0.9437
9	(3,2,2,5,2,2,7,2,2)	0.9513
10	(3,2,2,5,2,2,7,3,2)	0.9584
11	(3,2,2,6,2,2,7,3,2)	0.9635
12	(3,2,2,6,2,2,8,3,2)	0.9684
13	(4,2,2,6,2,2,8,3,2)	0.9716
14	(4,2,2,6,2,2,8,4,2)	0.9748
15	(4,2,2,6,3,2,8,4,2)	0.9782
16	(4,2,2,6,3,2,9,4,2)	0.9806
17	(4,2,2,7,3,2,9,4,2)	0.9828
18	(5,2,2,7,3,2,9,4,2)	0.9845
19	(5,2,2,7,3,2,10,4,2)	0.9862
20	(5,2,2,8,3,2,10,4,2)	0.9876

Table 5.3: Illustration of redundancy and diversity. The red entries indicate the subsystem and the type of extra component chosen at the specific stage.



components are allowed, we expect that type  $C$  would also be added, as diversity in redundancy allocation can result directly from maximisation of reliability, and is due to the limited knowledge about the reliability of the components of different types. As Coolen *et al.* [19] emphasize, this is an important reason for diversity that is different to the usually mentioned possibility of common-cause failures which would lead to all components of one type to fail.

In this example, the optimal allocations of up to 20 extra components are all such that one extra component would just be added to the optimal system structure derived when one fewer extra component is allowed. For systems with only one type of component per subsystem and different component types for different subsystems, it has been proven that adding extra components sequentially does lead to optimal redundancy allocation (see Chapter 2). As mentioned before, the basic idea of optimally allocating one more component, if one can increase  $m$  by one without changing  $k$ , is pretty straightforward, as one just calculates the NPI lower probabilities corresponding to all possibilities to add one component to the system and then chooses the type and subsystem leading to maximum improvement. However, if one can allocate more than one component, it is not clear that one can proceed with such one-step-at-a-time optimisation, which would lead to a simple algorithm. Based on the numerical computations in this example and some further cases we looked at, we strongly feel that such an algorithm would be optimal, as was the case for the more basic scenarios we considered before, but we have not yet achieved a mathematical proof of optimality for the systems in this chapter. In the example above, all possible scenarios were calculated and the given results are indeed optimal, so here one-step-at-a-time optimisation does lead to the overall optimal redundancy allocation in line with our conjecture that this will always lead to optimality for such systems.

## 5.6 Concluding remarks

This chapter has presented an important result in the development of NPI for system reliability, namely the lower and upper probabilities for the event that a system

with multiple subsystems, each a voting system, in series configuration functions successfully, where the different subsystems can have components of the same types. However, the mathematical complexity of these results is already quite substantial, while these systems still have relatively basic structures. In Example 5.2 an open problem for research was mentioned, namely to investigate whether or not sequential optimal allocation of extra components leads to optimal redundancy allocation. To solve a multi-dimensional optimisation problem, it is not generally sufficient to restrict to sequential one-dimensional optimisations. Of course, the main aim is to develop NPI for reliability of more complex system structures. Possibly the theory of signatures [51] may be of use, but the theory of signatures only applies to systems with a single type of component and it is not clear if it can be generalized to multiple component types. Further challenges are related to implementation of the results presented in this chapter for larger systems. In particular for large values of  $T$  and  $L$ , computational difficulties may appear due to the very large number of calculations involved, and it may be possible to derive suitable approximations. For risk assessment of safety-critical systems, which would only be used if tests had revealed zero failures [15], a reasonable lower bound for the NPI lower probability of system functioning may be sufficient to support decisions, with possible use of a corresponding upper bound for the NPI lower probability to indicate the accuracy of the approximation.

While these results may be perceived as having a rather abstract nature, they are readily available for implementation and the implications for practical reliability assessment can be considerable. By taking the uncertainty about reliability of components, resulting from limited test information, explicitly into account, which results in dependence of the random quantities representing the reliabilities of the components in the system, the overall system reliability can be very different from values that are perhaps more in line with intuition, as explained in examples and discussions in Coolen-Schrijner *et al.* [29]. This also affects the important aspects of redundancy and diversity related to system reliability, as briefly discussed in Example 5.2 and in more detail, but only for a single voting system, in Chapter 4.

# Chapter 6

## Conclusions

In this thesis, several extensions to Nonparametric Predictive Inference (NPI) for system reliability were presented. The NPI approach to system reliability is in early stages of development. It provides a new method for statistical inference on system reliability on the basis of limited information resulting from component testing.

In Chapter 2, the basic application of NPI for Bernoulli random quantities to inference on reliability of systems which are series of independent subsystems, with each subsystem a  $k^i$ -out-of- $m^i$  system with exchangeable components, was presented. With reliability measured by the NPI lower probability for system functioning, optimal redundancy allocation of extra components can be achieved, for any number of extra components, by sequential one-step optimal allocation. According to this technique, at each step an extra component is allocated to the subsystem for which the relative increase in reliability is maximal. The algorithm to determine the optimal sequence of adding the extra components to subsystems was described, and the proof of optimality was given. This result determined how to optimally allocate additional components for redundancy for any criterion in the case where the cost of components is irrelevant, or where they are the same for all components. If the costs of additional components differ per subsystem, and one aims to maximize system reliability under budget constraints, then the redundancy allocation problem becomes more complex. Fortunately this problem is close in nature to the well-known knapsack problems in discrete optimisation, and can be considered, after a simple modification, as a 0-1 knapsack problem.

In Chapter 3, an important step in the development of NPI for more complex system structures was introduced. The NPI lower and upper probabilities for functioning of a system consisting of multiple  $k_i$ -out-of- $m_i$  subsystems in a series configuration, with all subsystems consisting of the same type of component, was presented. This is non-trivial, as the random quantities representing whether the components in the system function or not, are not independent in the NPI approach, given the test results. It is important that this dependence is explicitly taken into account, in particular when there is relatively little information from tests. As a first step for this research, we generalized NPI for Bernoulli quantities to distinguish between subgroups of the  $m$  future observations, and using a path counting technique we derived lower and upper probabilities which quantify the reliability of such systems.

In Chapter 4, NPI for reliability of voting systems with multiple component types was presented. This is a further step in the development of NPI for system reliability, where more general system structures can be considered. Whilst restricting attention to a single voting system, this was now allowed to consist of multiple types of components. They are assumed to perform the same function within the system, but the test information differs per type of component, and in terms of their reliability components of the same type are exchangeable and assumed to be independent of components of other types. In addition to presenting the NPI lower and upper probabilities for system functioning, we addressed aspects of redundancy and diversity for such systems, where the benefit of having multiple types of components, with only limited test information per component type, was considered in detail.

In Chapter 5, we introduced a generalization of structure of the systems introduced in the previous three chapters by considering systems with a series structure where each subsystem is a single voting system consisting of different types of components. The important contribution of this chapter is that different subsystems can contain components of the same types. The results presented in this chapter generalize the results in Chapters 2, 3 and 4, and hence are the main results presented in this thesis.

Throughout this thesis, numerical examples illustrated some of the general properties for all systems considered. For example, the NPI upper probability for successful system functioning given  $s$  successes in  $n$  tests is equal to the NPI lower probability for successful system functioning given  $s + 1$  successes in  $n$  tests. The NPI lower (upper) probability for the case  $s = 0$  ( $s = n$ ) is equal to 0 (1), which reflects that in this case there is no strong evidence that the components can actually function (fail). The imprecision, that is the difference between corresponding NPI upper and lower probabilities, tends to decrease as a function of  $n$  and increase as a function of  $m$ , although the imprecision tends to become smaller for non-trivial events if both the upper and lower probabilities get close to either zero or to one. It will be of interest to study this in more detail, in particular as imprecision seems to relate logically to the amount of information available and to the number of future random quantities involved in the event of interest.

The basic idea of optimally allocating one more component, if one can increase  $m$  by one without changing  $k$ , is pretty straightforward, as one just calculates the NPI lower probabilities corresponding to all possibilities to add one component to the system and then chooses the type and subsystem leading to maximum improvement. However, if one can allocate more than one component, it is not clear that one can proceed with such one-step-at-a-time optimisation, which would lead to a simple algorithm. For systems with only one type of component per subsystem and different component types for different subsystems, it has been proven in Chapter 2 that adding extra components sequentially does lead to optimal redundancy allocation. Numerical examples presented throughout this thesis, and further cases we looked at, indicate that a similarly attractive algorithm will again be optimal for the systems considered in Chapters 3, 4 and 5, but proving this turned out to be rather complicated, and we have not achieved this.

The systems considered in Chapters 4 and 5 consist of multiple types of components. One of the main conclusions of these chapters is that considering diversity of components in a system is important to achieve maximum system reliability in situations with limited information about component reliability, but the optimal configuration depends on the actual system structure, with diversity generally most

useful for parallel systems, while for series systems one would not opt for diversity and only use components of the type that gave the best test results. We only showed this for the simple systems considered in these chapters, but we strongly feel that similar conclusions will hold for more general system structures when NPI lower probabilities are used to express system reliability.

In the reliability literature, system reliability is usually expressed as function of failure probabilities for components, which are typically assumed to be known. Under limited information, this will clearly not be the case, and the proper inclusion of uncertainty about components' failure probabilities is rarely addressed. One cannot replace parameters representing such failure probabilities by estimates, as the system reliability is typically a non-linear function of the failure probabilities. More importantly, any such a classical approach with parameters representing components' failure probabilities does not take into account the interdependence of the components to be used in the system of interest.

One can use a Bayesian approach, expressing the system reliability via a posterior predictive distribution, which will take care of this interdependence, but this requires the use of prior distributions for the parameters, which adds further assumptions that may be hard to justify. This is particularly clear when considering system reliability after zero-failure tests, where Bayesian methods will typically lead to a probability of system functioning that is less than one, while clearly the test data do not strongly suggest that components might actually fail. The use of lower and upper probabilities in reliability is attractive in such situations as the upper probability of system functioning, given no test failures, can be equal to one (as the NPI upper probabilities are), reflecting no evidence that things can go wrong. In such cases, the corresponding lower probability may be of most use, as it reflects the amount of evidence available in favour of system functioning, and as it enables cautious inference which is often deemed appropriate in risk analysis. The fact that the NPI lower and upper probabilities result from combinatorial arguments, based only on an exchangeability assumption and an underlying latent variable representation, is also attractive.

NPI lower and upper probabilities for system reliability are based on combinatorics, so the computation time will increase for more substantial systems. However, there are no complex integrals involved (as e.g. is typically the case in Bayesian statistics), and as all sums are finite there are no major computational difficulties. For large systems it may be required to consider approximations for the sums involved in deriving the NPI lower and upper probabilities, but NPI is not yet developed to the stage where this has become relevant. If more test data become available, updating the NPI lower and upper probabilities occurs by calculating them again using all combined information, there is no straightforward sequential updating algorithm available as is the case in Bayesian statistics.

The theory of system signatures [51] provides a powerful framework for reliability assessment for systems consisting of exchangeable components. Coolen and Alnafaiee [20] showed how signatures can be used within NPI to derive lower and upper survival functions for the failure time of such systems, given failure times of tested components, and to compare the reliability of two such systems. Signatures can also be used for reliability quantification for systems for which only failure or non-failure upon request for functioning is of interest, so without explicit focus on failure time. Applying this to systems with exchangeable components will be relatively straightforward and will generalize the results in Chapter 3, and analysis based on signatures might facilitate the proof of optimality of the presented redundancy allocation algorithm. This is left as a topic for future research.

Although a nonparametric approach as presented in this thesis is attractive, it has obvious limitations. For example, if NPI were developed further in order to take ageing of technical components into account, the huge amount of data needed to describe the effects of ageing without the use of a parametric model will make the approach of little practical value. One of the main research challenges for NPI will be to combine it with partial parametric modelling to model aspects of ageing using specific processes. This may lead to a novel semi-parametric approach that could be of benefit to a wide range of applications. The use of lower and upper probabilities in combination with stochastic processes is an exciting topic area for future research, which has not attracted much attention so far.

Throughout this thesis, several research challenges related to this NPI approach to system reliability and redundancy allocation have been mentioned. Several of these require some further development of NPI theory and methods, whereas others provide further analytical challenges or require development of suitable computational algorithms.



# Appendix A

## Brief guide to notation

$A_{(n)}$	Hill's inferential assumption.
$c^i$	cost to add one extra component to subsystem $i$ .
$C(\mathbf{j})$	total cost of these additional components being added to the whole system.
$j^i$	number of additional components added to subsystem $i$ .
$k$	minimum number of functioning components for a $k$ -out-of- $m$ system to function.
$k^i$	minimum number of functioning components for the subsystem $i$ to function.
$L$	total number of subsystems in the considered system.
$m$	total number of components in the considered system.
$m^i$	total number of components in subsystem $i$ .
$m_t$	total number of components of type $t$ in the considered system.
$m_t^i$	total number of components of type $t$ in subsystem $i$ .
$n$	total number of components that have been tested.
$n_t$	number of components of type $t$ that have been tested.
$\underline{P}(A)$	NPI lower probability for event $A$ .
$\overline{P}(A)$	NPI upper probability for event $A$ .
$\rho(i, j^i)$	factor with which the NPI lower probability for successful functioning of subsystem $i$ increases when $j^i + 1$ instead of $j^i$ extra components are added.
$s$	number of successfully tested components.
$s_t$	number of successfully tested components of type $t$ .
$T$	total number of component types in the considered system.
$Y_a^b$	random number of successes in trials $a$ to $b$ .

# Bibliography

- [1] Aboalkhair, A. M., MacPhee, I.M. & Coolen, F.P.A. (2009). Nonparametric predictive system reliability with redundancy allocation following component testing. *Proceedings Advances in Risk and Reliability Technology Symposium, 2009*, L. Bartlett (Eds), 396-407.
- [2] Aboalkhair, A.M., Coolen, F.P.A. & MacPhee, I.M. (2010). Nonparametric predictive inference for reliability of voting systems with multiple component types. *Proceedings 3rd International Conference on Accelerated Life Testing, Reliability-based Analysis and Design*. Clermont-Ferrand (France) Chateauneuf, Nikulin & Guerin (Eds), 175-182.
- [3] Aboalkhair, A.M., Coolen, F.P.A. & MacPhee, I.M. (2011). Nonparametric predictive inference for system reliability with subsystems consisting of multiple component types. *Proceedings Advances in Risk and Reliability Technology Symposium, 2011*, D. Prescott and R. Remenyte-Prescott (Eds), 322-339.
- [4] Aboalkhair, A.M., Coolen, F.P.A. & MacPhee, I.M. (2012). Nonparametric predictive inference for reliability of a series of subsystems with multiple component types. *Advances in Safety, Reliability and Risk Management*, Berenguer, Grall & Guedes Soares (Eds) Taylor & Francis Group, London, ISBN 978-0-415-68379-1, 1069-1077.
- [5] Aboalkhair, A.M., Coolen, F.P.A. & MacPhee, I.M. (2012). Nonparametric predictive inference for reliability of a  $k$ -out-of- $m$  :  $G$  system with multiple component types. In submission

- [6] Aboalkhair, A.M., Coolen, F.P.A. & MacPhee, I.M. (2012). Nonparametric predictive reliability of series of voting systems. In submission
- [7] Andrews, J.D. and Moss, T.R. (2002). *Reliability and Risk Assessment* (2nd Ed.). London: Professional Engineering Publishing Ltd.
- [8] Augustin, T. and Coolen, F.P.A. (2004). Nonparametric predictive inference and interval probability. *Journal of Statistical Planning and Inference* **124**, 251-272.
- [9] Birnbaum, Z. W., Esary, J. D. and Saunders, S. (1961). Multi-component systems and structures and their reliability. *Technometrics* **3**, 5577.
- [10] Boole, G. (1854). *An Investigation of the Laws of Thought on which are founded the Mathematical Theories of Logic and Probabilities*. Walton and Maberley, London.
- [11] Cai, K-Y. (1996). *Introduction to Fuzzy Reliability*. Boston: Kluwer Academic Publishers.
- [12] Coolen, F.P.A. (1998). Low structure imprecise predictive inference for Bayes' problem. *Statistics & Probability Letters* **36**, 349-357.
- [13] Coolen, F.P.A. (2004). On the use of imprecise probabilities in reliability. *Quality and Reliability Engineering International* **20**, 193-202.
- [14] Coolen, F.P.A. (2006). On nonparametric predictive inference and objective Bayesianism. *Journal of Logic, Language and Information* **15**, 21-47.
- [15] Coolen, F.P.A. (2006). On probabilistic safety assessment in case of zero failures. *Journal of Risk and Reliability* **220**, 105-114.
- [16] Coolen, F.P.A. (2007). Nonparametric prediction of unobserved failure modes. *Journal of Risk and Reliability* **221**, 207-216.
- [17] Coolen, F.P.A. (2010) *International Encyclopaedia of Statistical Sciences* (Nonparametric Predictive Inference chapter). Springer, Berlin.

- [18] Coolen, F.P.A., Aboalkhair, A.M. & MacPhee, I.M. (2009). Nonparametric predictive system reliability with all subsystems consisting of one type of component. In M.J. Kallen & S.P. Kuniewski (Eds), *Risk and Decision Analysis in Maintenance Optimization and Flood Management*, Amsterdam: IOS Press, 85-98.
- [19] Coolen, F.P.A., Aboalkhair, A.M. & MacPhee, I.M. (2011). Diversity in system reliability following component testing, *Journal of the Safety and Reliability Society* **30**, 75-93.
- [20] Coolen, F.P.A. and Al-nefaiee, A.H. (2012). Nonparametric predictive inference for failure times of systems with exchangeable components, *Journal of Risk and Reliability* to appear.
- [21] Coolen, F.P.A. and Augustin, T. (2005). Learning from multinomial data: a nonparametric predictive alternative to the Imprecise Dirichlet Model. In: T. Seidenfeld, R. Nau and F.G. Cozman (Eds.), *ISIPTA'05 - Proceedings of the Fourth International Symposium on Imprecise Probabilities and Their Applications*, Carnegie Mellon University, pp. 125-134.
- [22] Coolen, F.P.A. and Augustin, T. (2009). A nonparametric predictive alternative to the Imprecise Dirichlet Model: the case of a known number of categories. *International Journal of Approximate Reasoning* **50**, 217-230.
- [23] Coolen, F.P.A. and Coolen-Schrijner, P. (2005). Nonparametric predictive reliability demonstration for failure-free periods. *IMA Journal of Management Mathematics* **16**, 1-11.
- [24] Coolen, F.P.A. and Coolen-Schrijner, P. (2007). Nonparametric predictive comparison of proportions. *Journal of Statistical Planning and Inference* **137**, 23-33.
- [25] Coolen, F.P.A. and Yan, K.J. (2004) Nonparametric predictive inference with right-censored data. *Journal of Statistical Planning and Inference* **126**, 25-54.

- [26] Coolen-Schrijner, P. and Coolen, F.P.A. (2004). Adaptive age replacement based on nonparametric predictive inference. *Journal of the Operational Research Society* **55**, 1281-1297.
- [27] Coolen-Schrijner, P., Coolen, F.P.A. and Shaw, S.C. (2006). Nonparametric adaptive opportunity-based age replacement strategies. *Journal of the Operational Research Society* **57**, 63-81.
- [28] Coolen-Schrijner, P. and Coolen, F.P.A. (2007). Nonparametric predictive comparison of success-failure data in reliability. *Journal of Risk and Reliability* **221**, 319-327.
- [29] Coolen-Schrijner, P., Coolen, F.P.A. and MacPhee, I.M. (2008). Nonparametric predictive inference for system reliability with redundancy allocation. *Journal of Risk and Reliability* **222**, 463-476.
- [30] De Finetti, B. (1974). *Theory of Probability*. Chichester: Wiley.
- [31] Dempster, A.P. (1963). On direct probabilities. *Journal of the Royal Statistical Society, Series B* **25**, 100-110.
- [32] Dubois, D. and Prade, H. (1988), *Possibility Theory: An Approach to Computerized Processing of Uncertainty*. Plenum Press, New York.
- [33] Erylmaz, S. (2011). Circular consecutive  $k$ -out-of- $n$  systems with exchangeable dependent components. *Journal of Statistical Planning and Inference* **141**(2), 725-733
- [34] Gurler, S. and Capar, S. (2011). An algorithm for mean residual life computation of  $(nk + 1)$ -out-of- $n$  systems: An application of exponentiated Weibull distribution. *Applied Mathematics and Computation* **217**(19), 7806-7811
- [35] Hill, B.M. (1968). Posterior distribution of percentiles: Bayes' theorem for sampling from a population. *Journal of the American Statistical Association* **63**, 677-691.

- [36] Hill, B.M. (1988). De Finetti's theorem, induction, and  $A_{(n)}$  or Bayesian non-parametric predictive inference (with discussion). In: J.M. Bernardo, et al. (Eds.), *Bayesian Statistics 3*, 211-241. Oxford: Oxford University Press.
- [37] Hoepfer, V.M., Saleh, J.H. and Marais, K.B. (2009). On the value of redundancy subject to common-cause failures: Toward the resolution of an on-going debate. *Reliability Engineering & System Safety* **94**, 1904-1916.
- [38] Kuo, W. and Zuo, M.J. (2003). *Optimal Reliability Modeling: Principles and Applications*. Wiley, New York.
- [39] Lawless, J.F. and Fredette, M. (2005). Frequentist prediction intervals and predictive distributions. *Biometrika* **92**, 529-542.
- [40] Levitin, G. (2011). Linear  $m$ -gap-consecutive  $k$ -out-of- $r$ -from- $n$  :  $F$  systems. *Reliability Engineering & System Safety* **96**, 292-298.
- [41] Littlewood, B., Popov, P. and Strigini, L. (2002). Assessing the reliability of diverse fault-tolerant software-based systems. *Safety Science* **40**, 781-796.
- [42] MacPhee, I.M., Coolen, F.P.A. and Aboalkhair, A.M. (2009). Nonparametric predictive system reliability with redundancy allocation following component testing. *Journal of Risk and Reliability* **223**, 181-188.
- [43] Martello, S. and Toth, P. (1990). *Knapsack Problems: Algorithms and Computer Implementations*. Chichester: Wiley.
- [44] Maturi, T.A., Coolen-Schrijner, P. and Coolen, F.P.A. (2010). Nonparametric predictive inference for competing risks. *Journal of Risk and Reliability* **224**, 11-26.
- [45] Moghaddass, R., Zuo, M.J. and Wang, W. (2011). Availability of a general  $k$ -out-of- $n$  :  $G$  system with non-identical components considering shut-off rules using quasi-birthdeath process. *Reliability Engineering & System Safety* **96**, 489-496.

- [46] Paté-Cornell, M.E., Dillon, R.L. and Guikema, S.D. (2004). On the limitations of redundancies in the improvement of system reliability. *Risk Analysis* **24**, 1423-1436.
- [47] Rahrouh, M., Coolen, F.P.A. and Coolen-Schrijner, P. (2006). Bayesian reliability demonstration for systems with redundancy. *Journal of Risk and Reliability* **220**, 137-145.
- [48] Ruiz-Castro, J. E. and Quan-Lin Li (2011). Algorithm for a general discrete  $k$ -out-of- $n$  :  $G$  system subject to several types of failure with an indefinite number of repairpersons. *European Journal of Operational Research*, **211**(1), 97-111
- [49] Senz-de-Cabezn, E. and Wynn, H. P. (2011). Computational algebraic algorithms for the reliability of generalized  $k$ -out-of- $n$  and related systems. *Mathematics and Computers in Simulation* **82**(1), 68-78
- [50] Salehi, E.T., Asadi, M. and Erylmaz, S. (2011). Reliability analysis of consecutive  $k$ -out-of- $n$  systems with non-identical components lifetimes. *Journal of Statistical Planning and Inference* **141**(8) 2920-2932
- [51] Samaniego, F (2007). *System Signatures and their Applications in Engineering Reliability*. New York: Springer.
- [52] Tian, Z., Zuo, M. J. and Yam, R. C. (2009). Multi-state  $k$ -out-of- $n$  systems and their performance evaluation. *IIE Transactions* **41**, 32-44.
- [53] Torres-Echeverria, A.C., Martorell, S. and Thompson, H.A. (2011). Modeling safety instrumented systems with  $MooN$  voting architectures addressing system reconfiguration for testing. *Reliability Engineering & System Safety* **96**, 545-563.
- [54] Utkin, L.V. and Coolen, F.P.A. (2007). Imprecise reliability: an introductory overview. In: G. Levitin (Ed.), *Computational Intelligence in Reliability Engineering, Volume 2: New Metaheuristics, Neural and Fuzzy Techniques in Reliability*, 261-306. New York: Springer.

- [55] Vaurio, J.K. (1995). The probabilistic modeling of external common cause failure shocks in redundant systems. *Reliability Engineering & System Safety* **50**, 97-107.
- [56] Vaurio, J.K. (2011). Unavailability equations for  $k$ -out-of- $n$  systems. *Reliability Engineering & System Safety* **96**, 350-352.
- [57] Walley, P. (1991). *Statistical Reasoning with Imprecise Probabilities*. London: Chapman and Hall.
- [58] Weichselberger, K. (2000). The theory of interval-probability as a unifying concept for uncertainty. *International Journal of Approximate Reasoning* **24**, 149-170.
- [59] Weichselberger, K. (2001). *Elementare Grundbegriffe einer allgemeineren Wahrscheinlichkeitsrechnung I. Intervallwahrscheinlichkeit als umfassendes Konzept*. Heidelberg: Physika.
- [60] Williamson, J. (2004). Philosophies of probability: objective Bayesianism and its challenges. *Handbook of the Philosophy of Mathematics*, Volume 9 of the *Handbook of the Philosophy of Science*, Irvine, ed., Elsevier.