



Durham E-Theses

A comparative study of the productivity, mineral regime and floristic composition of the management units found on a Teesdale hill farm

M.Nye, Sandra

How to cite:

M.Nye, Sandra (1971) *A comparative study of the productivity, mineral regime and floristic composition of the management units found on a Teesdale hill farm*, Durham theses, Durham University. Available at Durham E-Theses Online: <http://etheses.dur.ac.uk/10379/>

Use policy

The full-text may be used and/or reproduced, and given to third parties in any format or medium, without prior permission or charge, for personal research or study, educational, or not-for-profit purposes provided that:

- a full bibliographic reference is made to the original source
- a [link](#) is made to the metadata record in Durham E-Theses
- the full-text is not changed in any way

The full-text must not be sold in any format or medium without the formal permission of the copyright holders.

Please consult the [full Durham E-Theses policy](#) for further details.

A Comparative Study of the Productivity,
Mineral Regime and Floristic Composition
of the Management Units Found on a
Teesdale Hill Farm.

by

Sandra M.Nye

Being a thesis submitted to the University
of Durham in fulfilment of the regulations
governing the degree of Master of Science.

1971



ACKNOWLEDGEMENTS

I would like to thank N.E.R.C. for the grant which enabled me to undertake this study at Durham, and to thank Mr. E.Bell for allowing me to use his farm as my study area. Also I am very grateful for all the help and encouragement that Dr. D. J. Bellamy, my family and all my friends in the Dale and in South Africa have given me.

INDEX

	Page
Abstract	1
Preface	3
Introduction to Study Problem	4
Site Selection	5
Soil Profiles	9
Floristic Differences	19
The Main Study-Methods.	22
Part I. Production of the Communities	24
Summary	57
Part II. Mineral Regime of the Communities.	63
Mineral "Budget" of each Community	87
Conclusions	91
Phytosociological Survey of Unmown Areas of Hay Meadow	94
References	96
<u>Appendices.</u>	
1 Results of Soil Analyses	98
2 Histograms to show dry weight of Plant material at each Sample time	112
3 Number of Individuals of each species per square metre at each Sample time	116
4 Performance of Five Selected Species during Growing Season of 1969	118

Appendices contd.

5	Results of Mineral analyses of each Species at each Sample Time.	126
6	Mineral Content (mg/m^2) of the Whole Community, the Living Plant Material, and the Debris	171
7	Mineral Content (% of the maximum total present) of the Whole Community, the Living Plant Material, and the Debris	174
8	Ratios of Mineral "Con- centration" x 10 of the Whole Community, the Living Plant Material, and the Debris	184
9	Comparison of the Standing Crop and Mineral Composition of Five Hay Meadow Communities.	185
10	Results of Analysis of Phytosociological Data . . .	203

ABSTRACT

Teesdale, situated in the eastern Pennines, is subject to rather severe climatic conditions which only allow a short growing season. Nevertheless a rich unique flora is found here and hill farming is practised.

The hill farms consist of lush hay meadows on the alluvial soil of the valley bottoms, and of rough grazing on the Fell slopes. The meadows are fertilized, mown and grazed, and some fertilizers have also been applied to the lower Fell slopes.

Originally the Dale was forested and some relic species, e.g. Anemone nemorosa are still found. To-day's vegetation is a mixture, the more "managed" grassland showing affinities to the order ARRHENATHERETALIA Pawloski 1928, and the remainder to the order MOLINIETALIA W.Koch 1926. "Management" seems to aid species of the former order in replacing species of the latter.

The hay meadows are the most productive, the most important contributors being the grasses, especially Holcus lanatus, Alopecurus pratensis, and Festuca rubra. The most productive group of plants higher on the Fell slope were the bryophytes. Calculation of the productivity of each species enables the best "niche" for each species to be determined.

"Management", by increasing productivity and thus organic and inorganic nutrient turn-over, must have affected the natural cycling and retention of nutrients. The more productive communities are less "efficient" in their utilization of potassium. Analysis of the component species could identify the plants between which maximum competition occurs, and which minerals are limiting growth.

A study of this type, including total mineral "budget" of the environment, extending over a sufficient number of years and using a statistically sound number of samples, could lead to the production of seed mixtures which may improve the hay crop and grazing swards. Improvements in "management" especially fertilization, could also be suggested, since increased production depends on increased mineral supply.

PREFACE

The uplands of the Northern Pennines are covered for their greater part by tracts of "dreary monotonous" moors (Tansley 1911), which contrast markedly with the green of the richer vegetation of the dale bottoms.

Upper Teesdale is one such dale which is noted for its rich and peculiar flora (Pigott 1956). Much attention has been (e.g. Blackhouse 1843 & 1844, Pearsall & Mason 1925), and is at present (e.g. Bellamy et al. 1969) being paid to its unique vegetation. This work sets out to gain at least some comparative data relating to the man-made ecosystems of the Dale.

INTRODUCTION TO THE STUDY PROBLEM

A typical Upper-Dale farm system consists of the following management units:-

- (1) Meadows on the alluvial soils of the valley floor.
- (2) Inbyeland consisting of fenced grazing on the valley slopes, which are covered with glacial drift.
- (3) Outbyeland consisting of unfenced grazing on the slopes higher on the valley edges.

The pattern is complicated with wet depressions, springs, stream sides, rocky outcrops and major breaks of slope which add a variety of pattern to the landscape and the vegetation. The boundary between units (1) and (2) is a natural one, being the boundary of the alluvial and boulder clay soils. The boundary between units (2) and (3) is mainly one of differing type of "management" and/or length of "management".

The aim of the research is a comparative study of the following aspects of each farm unit:-

- (1) Floristic composition.
- (2) Productivity-measured as above ground net biomass increase over a set period of time.
- (3) Mineral regime of the communities.
- (4) Performance of certain selected species-measured as net biomass increase.



SITE SELECTION

The research site was chosen after an extensive survey of the Upper Valley and three field systems were selected for study. A transect was laid down from Grid Ref. NY 860290 on the valley side to Grid Ref. NY 863293 on the bank of the River Tees. On the basis of the Floristic Survey six areas, representative of the main association variants present, were chosen for detailed study (see sketch map-Fig.1). The relevant ecological and management details of each are given below.

AREAS 2 AND 3

These are representative of the alluvial meadows. The meadows are grazed by sheep for approximately 9 months of the year. The sheep are removed in early

MINERAL CYCLE DIAGRAM OF AREAS 2 AND 3

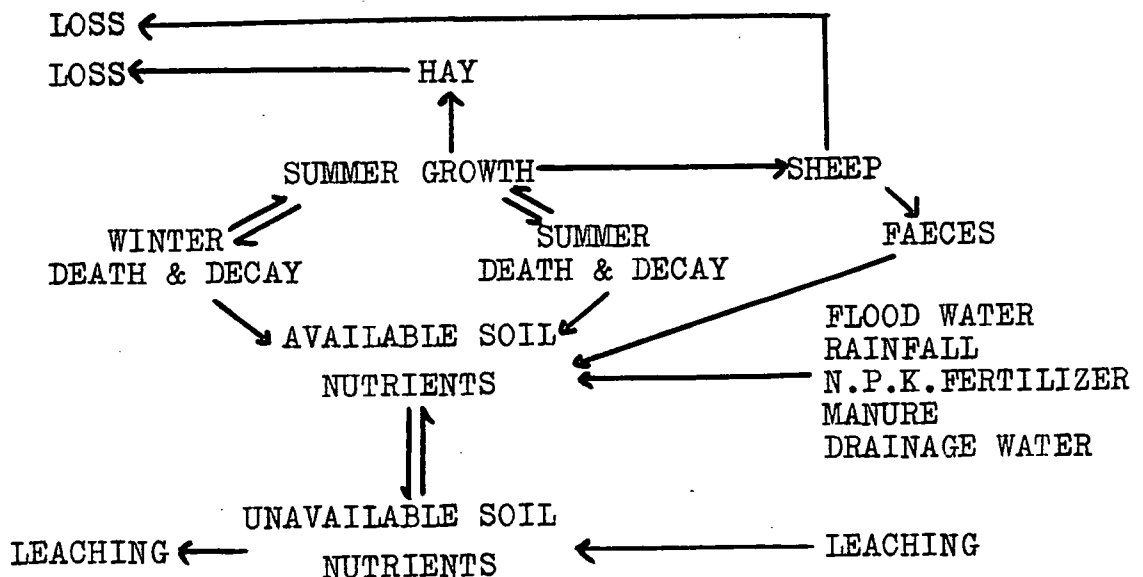

June, and the hay crop is allowed to develop. This is mechanically harvested in late July, the sheep being returned in late August. The whole area receives a light dressing of straw-rich farmyard manure in

FIGURE 1

MAP OF EXPERIMENTAL AREA
(FROM O.S. SHEET NY 82 NE.)

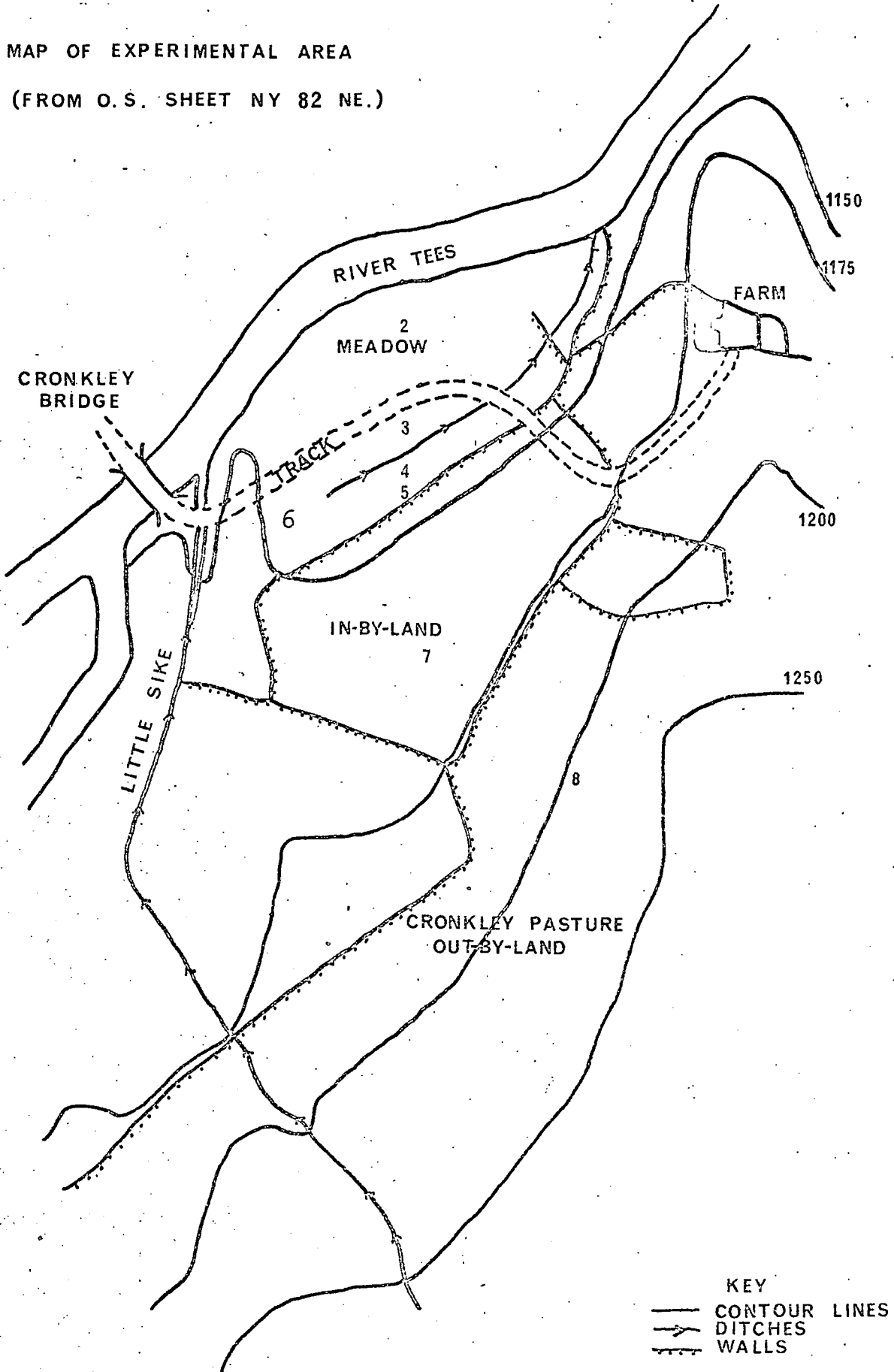

Figure to show position of experimental areas.
2, 3, 4, 5, 6, 7 and 8.

November/December and an artificial N.P.K. fertilizer (ICI. 12.12.18) mixture in May. The latter is applied in the form of slow leaching granules, at the rate of 2.5cwt. per acre. Lime is also added at very irregular intervals, the last recorded liming was carried out in 1964. The meadows are also subject to deposition of allochthonous material (silt etc.) during periods of flooding, the more low-lying area (area 2) being more regularly subject to this natural fertilization. Area 3, on the other hand, is situated on a dome of alluvium where leaching might be expected to play a significant role in the mineral balance.

AREA 4

A wet depression in the alluvial soil at the foot of the Fell slope. This area is never mown or fertilized

MINERAL CYCLE DIAGRAM OF AREA 4

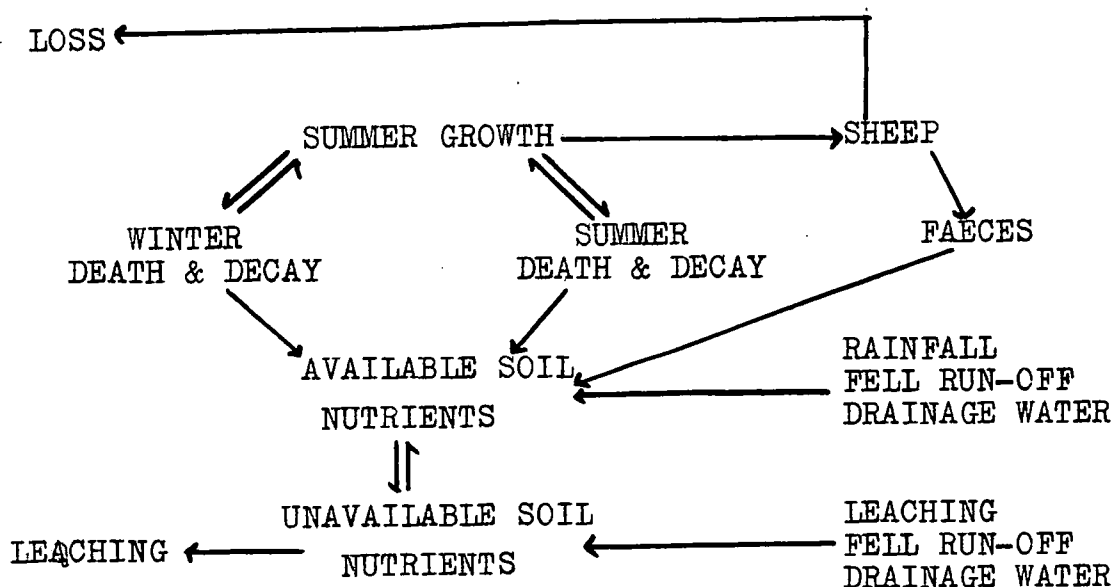

and must be affected by all the water and minerals washed from higher up its catchment.

AREA 5

Situated on the top of a bank of glacial drift in the meadow, is never artificially fertilized and is mown only in good hay seasons. This area has a slope of about 10° -the previous three are flat.

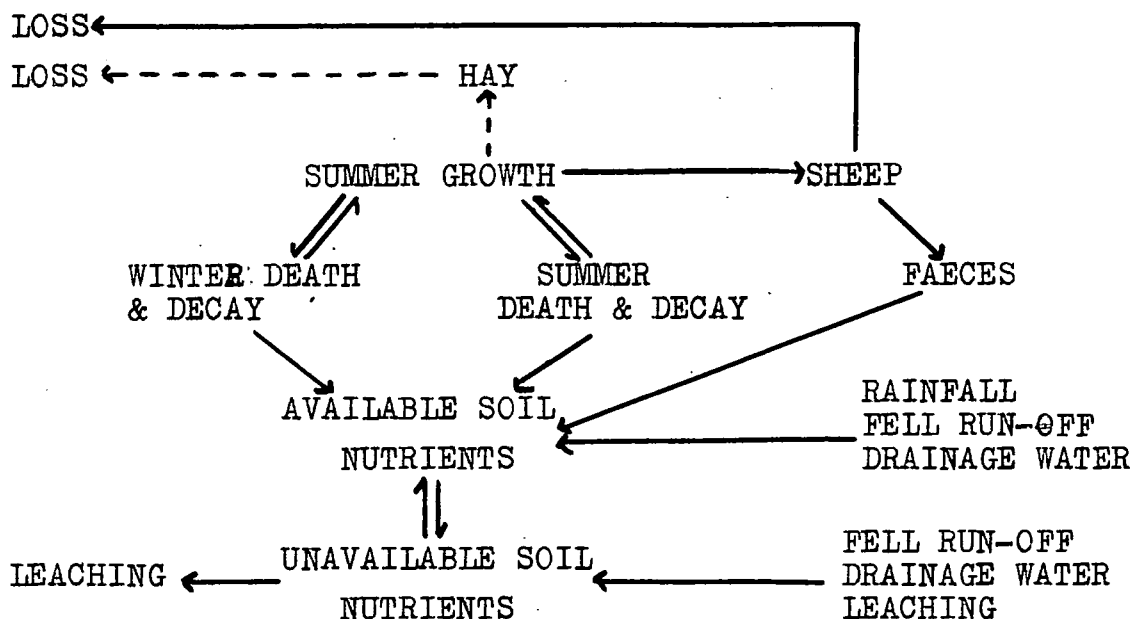
MINERAL CYCLE DIAGRAM OF AREA 5AREA 7

Representative of the inbyeland. This was formed by enclosing an area of rough grazing and moorland (outbyeland) about 15 years ago. For the first few years it was treated with annual applications of lime and artificial fertilizer (unfortunately no exact records are available), now it is grazed for most of the year and is unmown. The slope is irregular-varying around 25° .

AREA 8

This is higher up the Fell slope in the outbyeland, is lightly grazed all the year and has never had any

fertilizers or lime added. It may be assumed that water draining off the Fell and surface run-off cause considerable leaching of minerals at these three latter areas.

MINERAL CYCLE DIAGRAM OF AREAS 7 AND 8

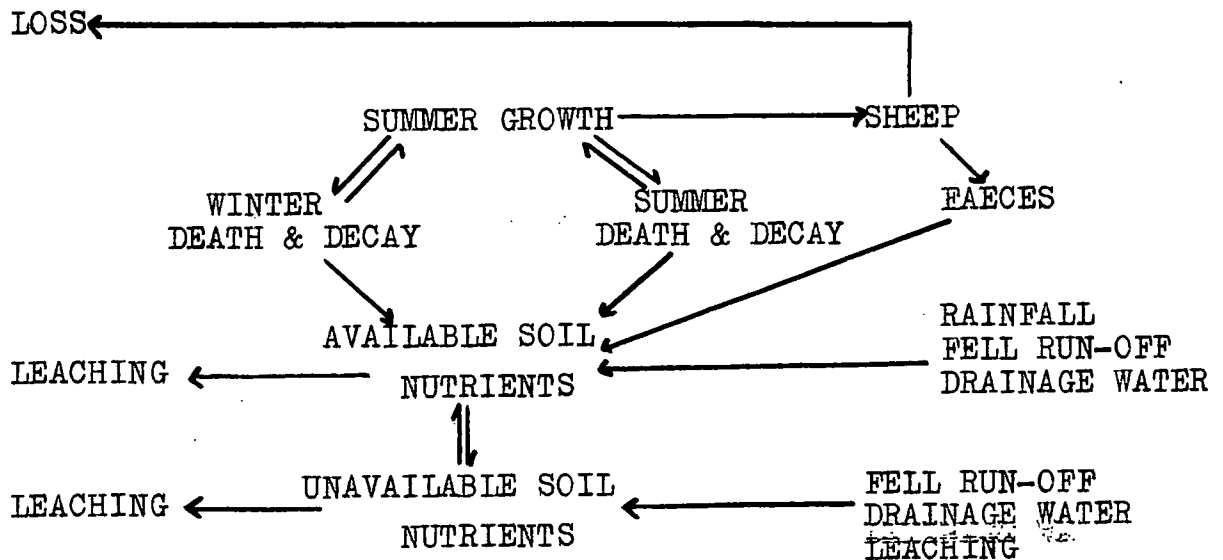

AREA 6

This area is situated away from the transect. It is in a hollow on the bank of glacial drift in the meadow. It is never mown or fertilized, but the flow of the water bringing leached minerals from higher up the slope is probably checked here—due to the sudden reduction in angle of slope—and hence, this area has probably an enriched soil. The soil is very wet but the water is not stagnant.

SOIL PROFILES

The soil of the farm was sampled and tested by Benham (M.Sc.Thesis 1969, see Appendix 1 for his results), and a very brief review of his findings will be given here. The soil samples were collected in May, before

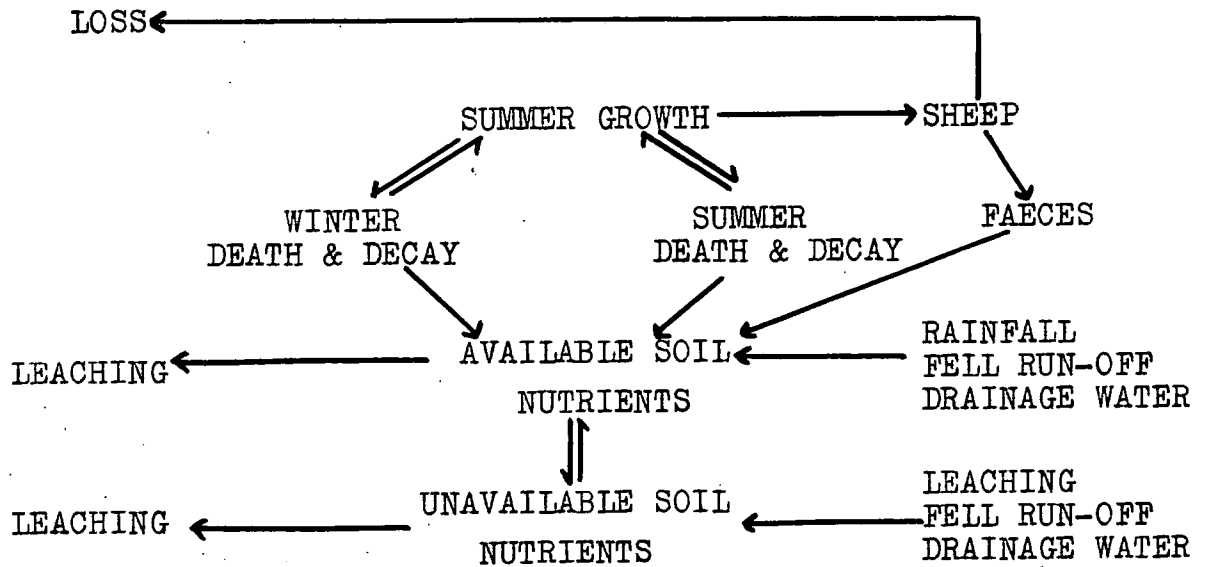
MINERAL CYCLE DIAGRAM OF AREA 6

any artificial fertilizer had been applied. At all areas plant roots only extended to a depth of 32 cm.

The pH values ranged from 5.0 to 6.8. The two most water-logged areas tested by Benham—areas 4 and 8—had the lowest pH values. This would be due to the high rainfall of the area (50–55 inches per year) both leaching the soil (Pigott 1956) and causing a reduction of the oxidation processes due to water-logging (Pearsall 1950). The soil at area 5 (pH 6.6) is leached but well aerated, and at area 2 (pH 6.8) is leached, well aerated and infrequently limed. Fig. 2 compares the oxygen status of these soils.

AREA 8

The soils of this area and of area 7 are gley soils. The profile changes rapidly from an upper humus-rich layer to a pale, rather anaerobic, boulder clay (Fig. 3), typical of gleyed soils (Pearsall 1950). The lower strata of clay are stained with humic material and ferrous salts. The parent material is impermeable clay and the flow of drainage water downhill is along the humus-rich, clay interface. Mineral analysis

FIGURE 2 Oxygen Status of the Soils.

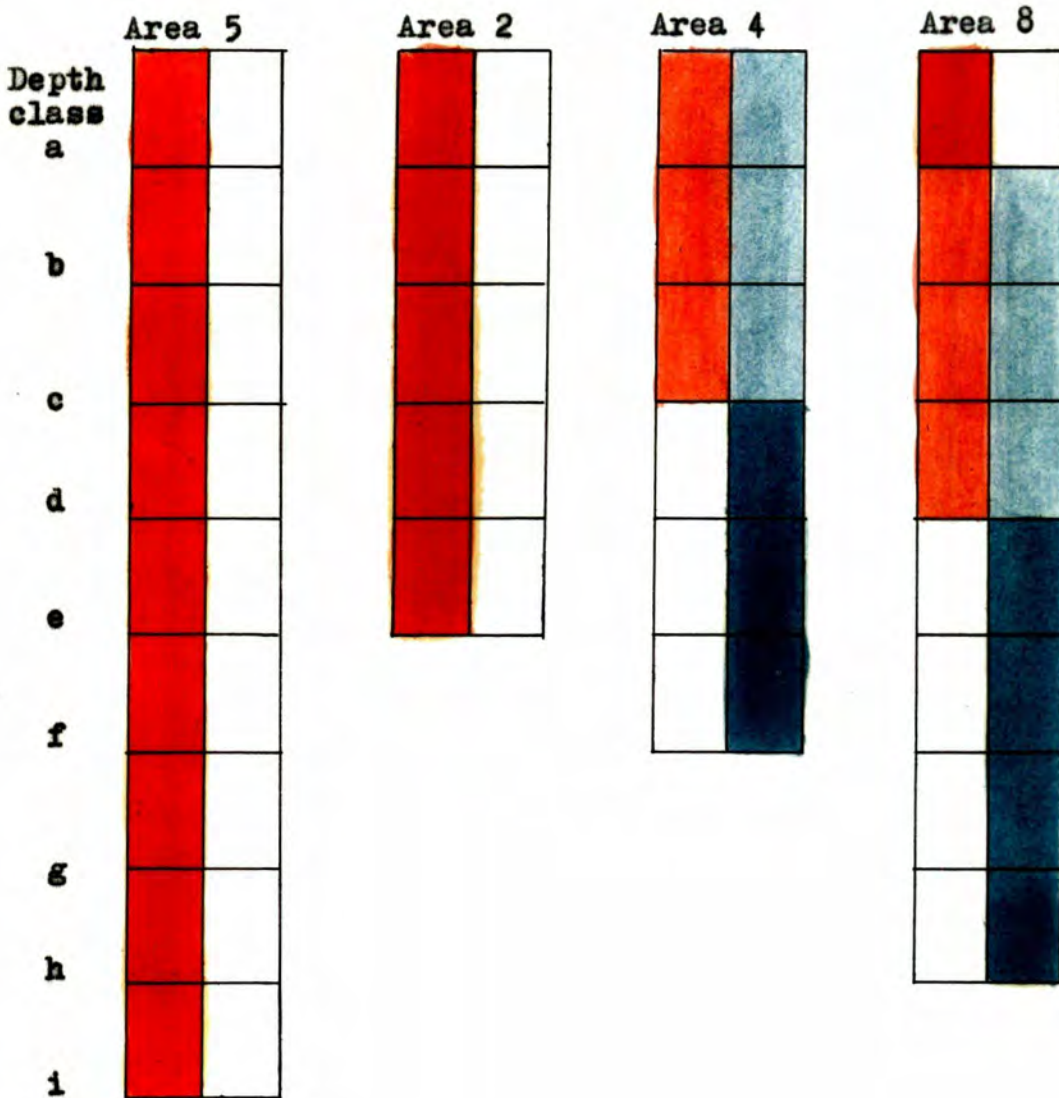
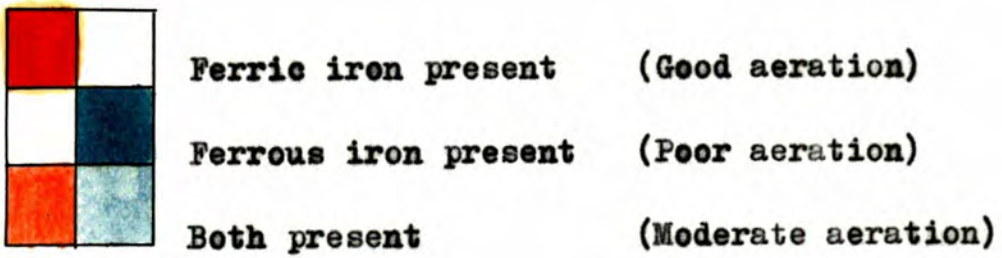

FIGURE 3

Soil Profile of Outbyeland-Area 8

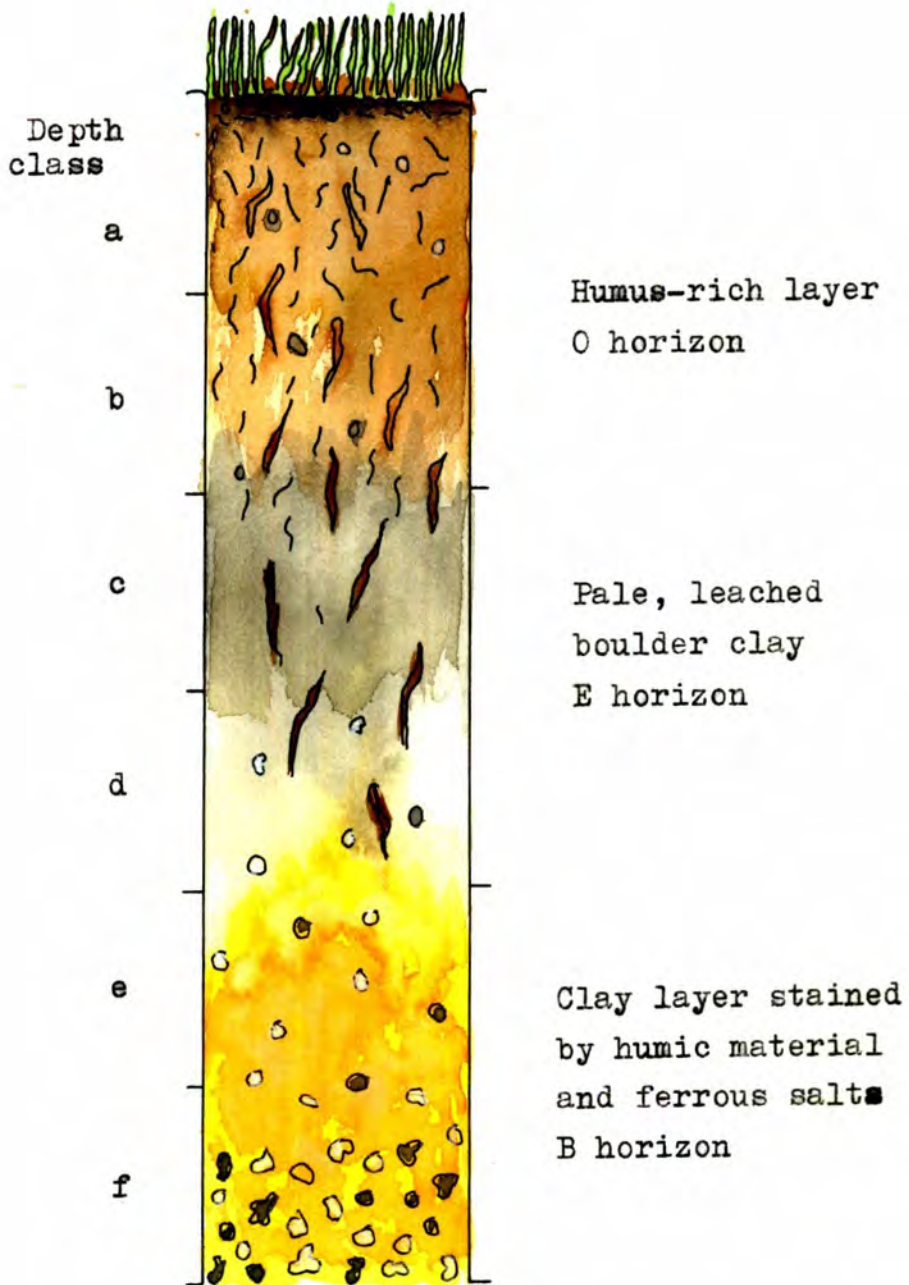

FIGURE 3 contd.

Soil Profile of Inbyeland-Area 7

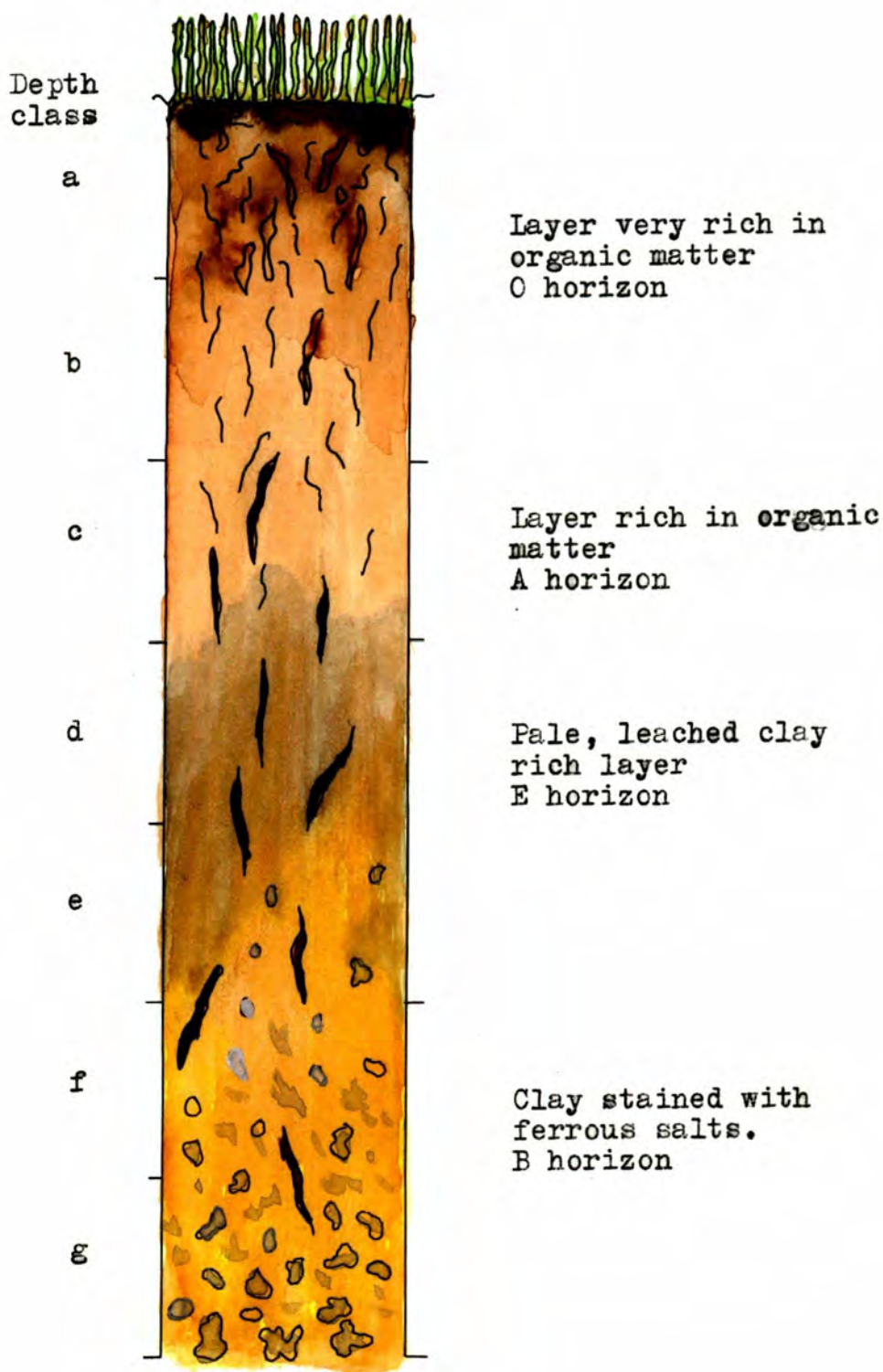
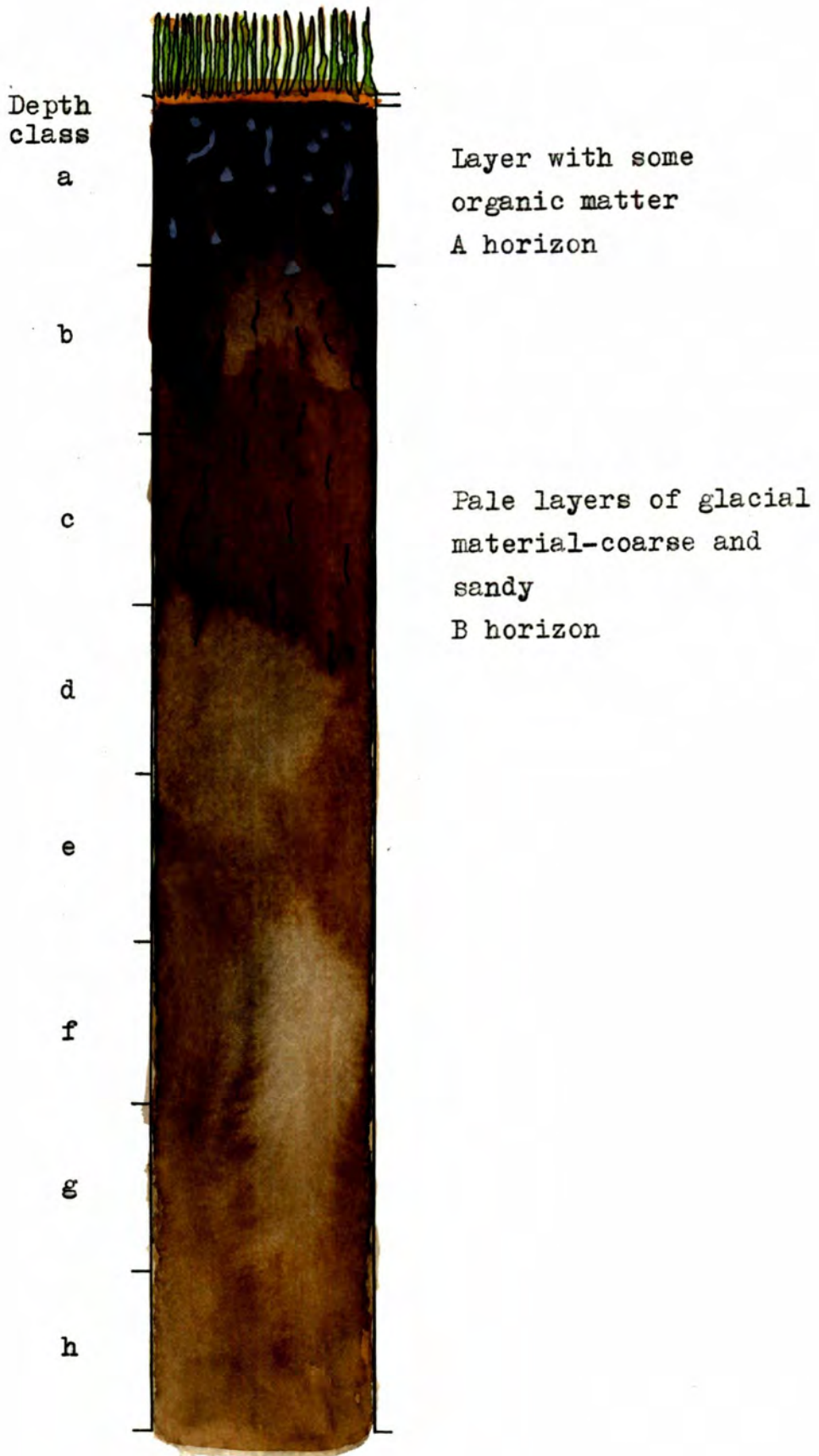

FIGURE 4

Soil Profile of Area 5



shows that there is less sodium, potassium and phosphorous at this interface than elsewhere. As this soil is heavily leached only small amounts of mineral nutrients are present, calcium, magnesium and carbonate ions are at very low levels in the humus-rich surface layers and abundant in the lower clay-rich layers, and nitrate is present in small amounts throughout.

AREA 5

The soil here resembles that of the present day river bank, it is aerobic, free-draining, and coarse, with little organic material. (Fig. 4) Calcium, magnesium and carbonate ion levels increase with depth, nitrate and potassium decrease, sodium and phosphorous show a slight decrease. The sudden drop in mineral content at about 60 cm. of all minerals tested could be due to the leaching effect of the drainage water percolating through the soil at this level, or because the soil has little organic material.

AREA 4

The soil profile (Fig. 5) shows a humus-rich layer overlying an anaerobic clay layer which shows signs of gleying. Under this there is a band of sand on top of a "fossilized meadow soil" developed on the rounded stones typical of a river bed. The soil is peaty, poorly drained with low mineral content. Calcium and carbonate ion contents increase with depth, magnesium and potassium decrease with depth, phosphorous repeats the pattern noted at area 8, and nitrate ions and sodium are in low amounts throughout the profile.

AREA 2

The meadow soil (areas 2 and 3) is shallow, alluvial,

FIGURE 5 Soil Profile of Area 4

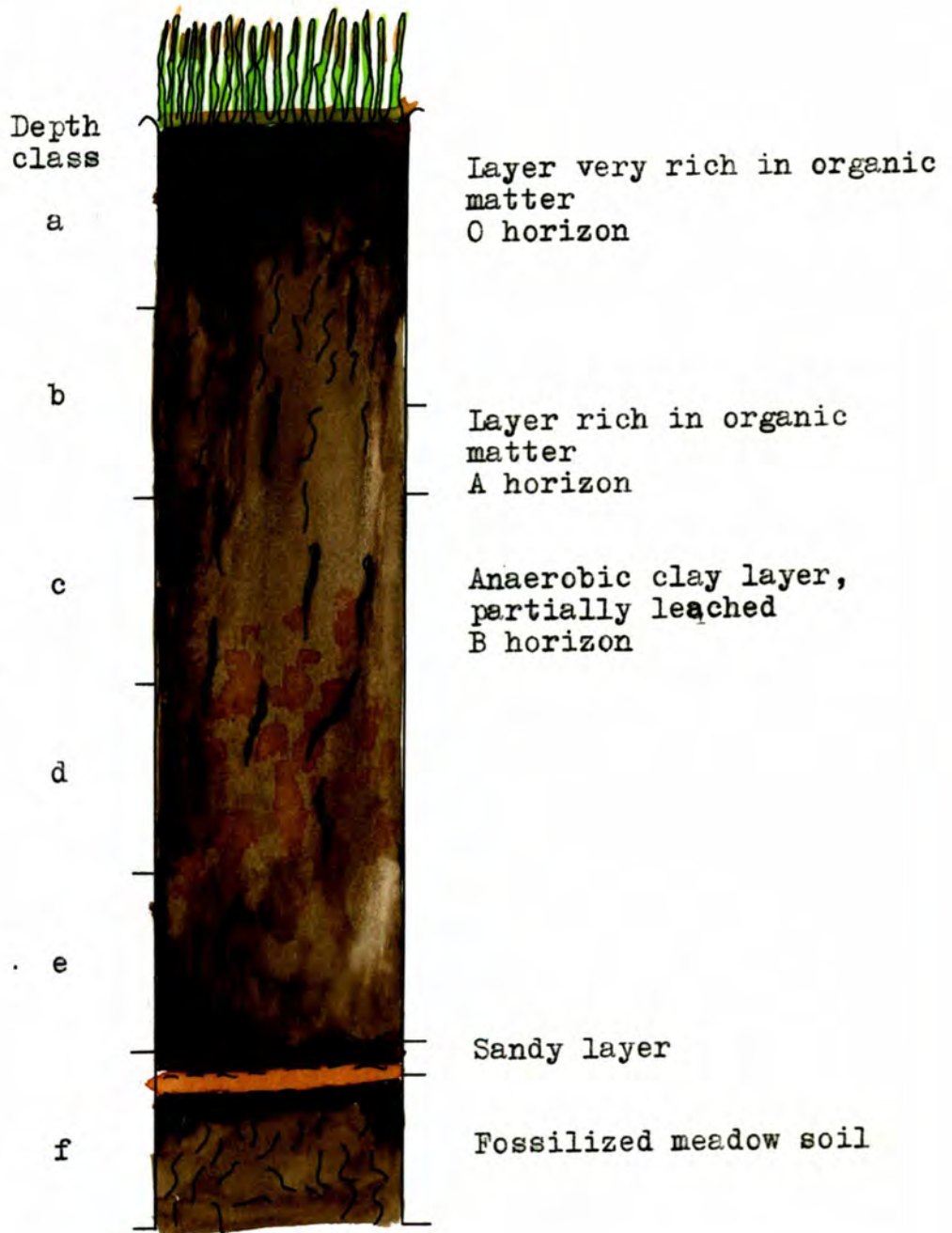

FIGURE 6 Soil Profile of Hay Meadow—Area 2

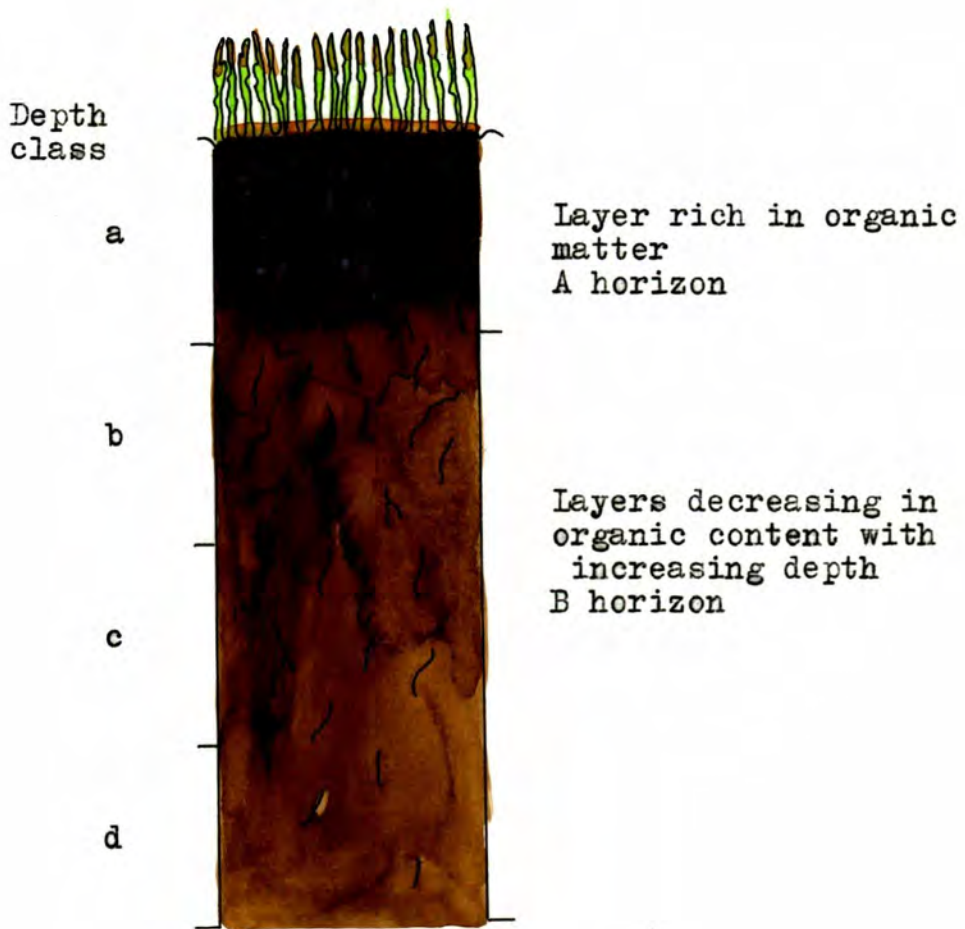
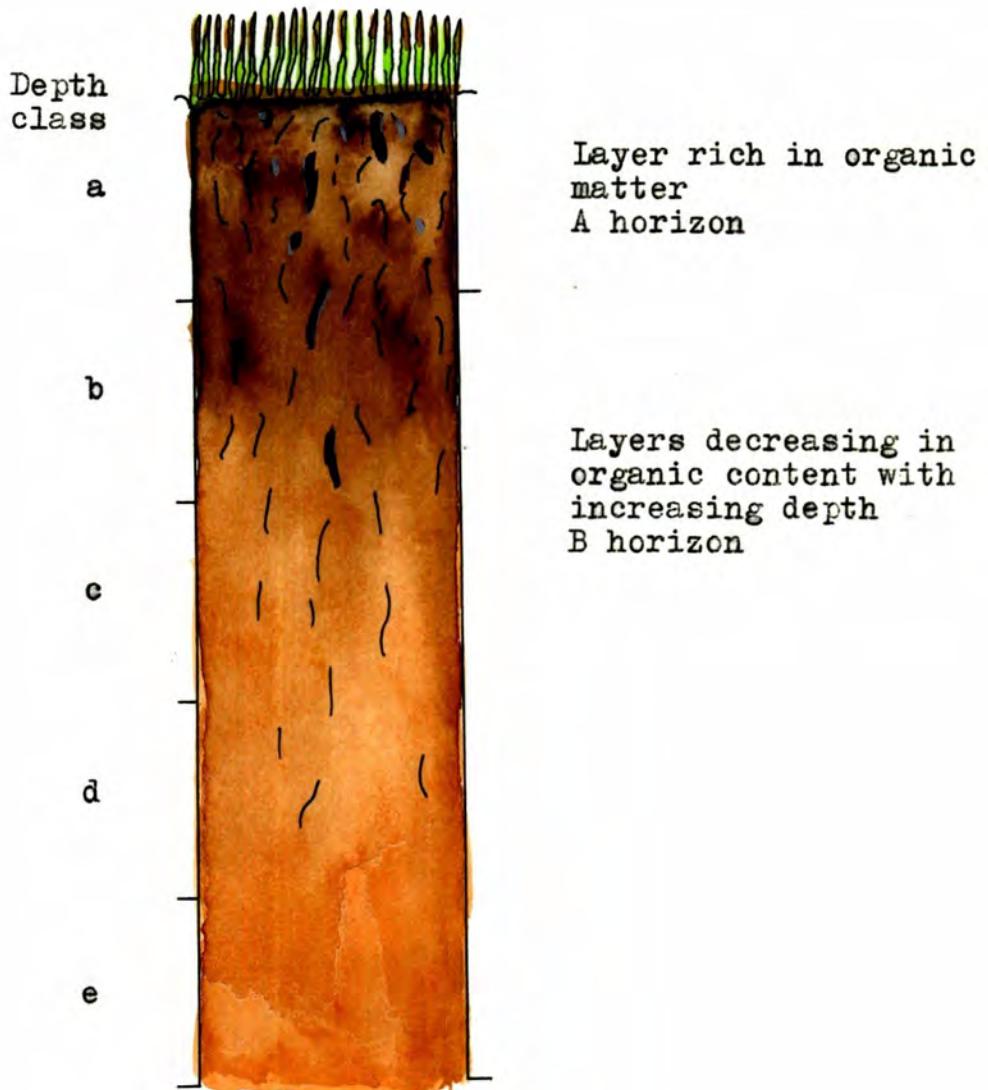

FIGURE 6 contd. Soil Profile of Hay Meadow—Area 3



free-draining and well aerated with a graded humus distribution throughout the profile (Fig. 6). Sodium and magnesium, the two minerals tested for which are not added in the fertilizer, increase with depth. Potassium, calcium, carbonate and phosphorous decrease with depth.

At all areas the percentage organic matter in the soil decreases with depth, it is very low throughout the profile of area 5, and is very high in the surface layers at areas 8, 7 and 4. At these three areas this is probably an important source of minerals.

FLORISTIC DIFFERENCES BETWEEN THE SIX AREAS

The main floristic differences between the six study areas are given in Table 1. Further analysis of the floristic data is given on pages 57 and 94, together with tentative naming of the units present using the nomenclature of the Zurich-Montpellier School of Phytosociology.

TABLE 1 Floristic Differences of the
Six Study Areas

Table of constant and characteristic species-i.e. those found at all four sample times, and the number of quadrats each species was found in on each sampling occasion (5 quadrats were studied at each time).

<u>SPECIES</u>	<u>AREA 2</u>	<u>AREA 3</u>	<u>AREA 4</u>	<u>AREA 5</u>	<u>AREA 7</u>	<u>AREA 8</u>
<i>Agrostis tenuis</i>	4522					
<i>Alopecurus pratensis</i>	1143	2553				
<i>Bromus mollis</i>	5451	2354				
<i>Holcus lanatus</i>	4555			5455	5453	
<i>Festuca rubra</i>	3523	5552		5555	5353	1141
<i>Cerastium holostæodes</i>	4453	3242		5442		
<i>Ranunculus bulbosus</i>	5325	5352		5555		
<i>Poa trivialis</i>	5455	5345		5333		
<i>Rumex acetosa</i>	5545	5554		2233		
<i>Rhinanthus minor</i>		2141		5515		
<i>Brachythecium rutabulum</i>		3143		3214		
<i>Luzula campestris</i>				2354		
<i>Carex caryophylla</i>				2444		
<i>Anemone nemorosa</i>				4334		
<i>Plantago lanceolata</i>				5555		
<i>Centaurea nigra</i>				2333		
<i>Acrocladium cuspidatum</i>				1431	3544	
<i>Anthoxanthum odoratum</i>				4555	4353	5543
<i>Poa pratensis</i>					2211	
<i>Festuca ovina</i>					5322	
<i>Prunella vulgaris</i>					1121	
<i>Rhynchospora squarrosa</i>					1355	5555
<i>Agrostis canina</i>					1332	5545
<i>Nardus stricta</i>					4322	4544
<i>Carex panicea</i>			5554		4352	5435
<i>Carex pulicaris</i>			5134		5225	
<i>Eriophorum angustifolium</i>			5525			
<i>Molinia caerulea</i>			5555			

TABLE 1 contd.

<u>SPECIES</u>	<u>AREA 2</u>	<u>AREA 3</u>	<u>AREA 4</u>	<u>AREA 5</u>	<u>AREA 7</u>	<u>AREA 8</u>
Thuidium tamariscinum						3324
Hylocomium splendens						3323
Lophocolea bidentata						5444

THE MAIN STUDY

AIMS

- (1) To calculate the productivity, measured as above ground net biomass increase-Part I.
- (2) To study the mineral regime of the communities-Part II.
- (3) To measure the performance, or net biomass increase of selected species.

METHODS

In order to be able to obtain the most useful data in the time available it was decided to restrict the study to the period of time during which the hay crop was developing in the meadows, and only to study the following minerals-sodium, potassium, magnesium and calcium. That is, it was decided to compare certain aspects of the production(net increase in the above ground standing crop, or biomass, and distribution of 4 cations within this crop) during the most agriculturally important period of development.

A. METHOD USED IN FIELD SEASON 1968

Each area was sampled at regular intervals throughout the growing season. Each sample consisted of 5 randomly placed 255 cm² round quadrats. The vegetation and its supporting column of soil was collected in each case using a post hole auger. Each quadrat sample was placed in a clean polythene bag and brought back to the laboratory for analysis. As it was impossible to positively identify all the components of the litter, all the dead leaves and surface plant debris removed from the 5 quadrats of each sample were bulked

together. Each plant individual was then harvested by cutting off at ground level. The plants from each sample were then sorted into species (or subcrops) and counted, each grass or creeping plant tiller or shoot being counted as one individual. Bryophytes were simply sorted into species.

Each subcrop was then dried to a constant weight in a forced air oven at 99°C. Wherever the dry weight exceeded 0.5 g the subcrop was analysed for minerals. All subcrops from one set of 5 quadrats which weighed less than 0.5 g were bulked for analysis. The minerals were extracted by wet digestion with concentrated nitric acid (10ml), perchloric (5ml) and hydrochloric acid (10ml) (Jefferies & Willis 1964). The clear solution obtained was diluted to 250ml and the concentration of sodium and potassium determined by flame photometry, and of magnesium and calcium by atomic absorption spectrophotometry.

B METHOD USED IN FIELD SEASON 1969

Sheep-proof exclosures were erected in 5 of the areas, 2, 5, 6, 7 and 8. They were 4 m² in size and the one situated in the hay meadow received the same fertilizer treatment as the area outside. From the results obtained by the above method, 5 species were selected (Holcus lanatus, Festuca rubra, Anthoxanthum odoratum, Rhinanthus minor and Trollius europaeus) and their increase in dry weight during the growing season was followed, both inside and outside the exclosures, by frequent cropping. A minimum of 20 individuals of each species were collected each time. They were cropped by cutting at ground level and all the dead leaves associated with each individual were also collected.

PART IPRODUCTION OF THE COMMUNITIESAIM:- MEASUREMENT OF ABOVE-GROUND STANDING CROP AND ESTIMATION OF PRODUCTION

Figures for the above-ground standing crop (designated as biomass below) for each component species at each site were obtained at intervals over the period 24th. May 1968 to 5th. August 1968. The results are expressed as g per m² per species, and the mean dry weight per plant in mg. Table 2 shows the change in biomass of the main components recorded over the study period. Areas 2 and 3 were mown in late July, hence no figures are presented for the August cropping. It is immediately obvious that figures calculated from single peak crop results are meaningless and that the fuller the actual analysis of the community by increment cropping and sorting of the species present, the more meaningful will be the production figures for comparative purposes. Table 2 does however show the importance of each component group of plants in the total community, showing for example that the Bryophytes are an important part of the ecosystem at area 8 and Dicotyledons at areas 5 and 2. The full biomass results of each species are presented in Tables 3, 4 and 5. Appendix 3 gives the number of individuals of each species per m².

The most abundant grass species in the mown parts of the meadow were Festuca rubra, Poa trivialis, Holcus lanatus, and Bromus mollis. Cerastium holostoides was the most common dicotyledon. In addition to these species, in area 5, Cynosurus cristatus, Ranunculus bulbosus, Rhinanthus minor and Plantago lanceolata were very numerous. Festuca ovina, Nardus stricta, Agrostis sanina and Carex pulicaris were common in

TABLE 2 Total dry weight (g per m²) and change in standing crop of each group of plants during the study period. (see Fig. 7 and Appendix 2)

Date	Dry weight (g per m ²)					Change in dry weight	
	24.5.68	7.5.68	21.6.68	11.7.68	5.8.68	24.5.68- 11.7.68	24.5.68- 5.8.68
AREA 2							
Grasses	55	74	165	203		+148	
Dicotyledons	24	37	127	84		+ 60	
Bryophytes	3	2	0	1		- 2	
Debris	76	64	46	58		- 18	
TOTAL	158	177	338	346		+208-20	
AREA 3							
Grasses	67	76	180	408		+341	
Dicotyledons	25	35	83	38		+ 13	
Bryophytes	6	4	2	1		- 5	
Debris	93	98	103	61		- 32	
TOTAL	191	213	368	508		+354-37	
AREA 4							
Grasses	18	20	26	63		+ 45	
Dicotyledons	1	2	0	3		+ 2	
Bryophytes	5	2	1	19		+ 14	
Sedges	54	58	86	95		+ 41	
Debris	115	87	181	137		+ 22	
TOTAL	193	169	294	317		+123	
AREA 5							
Grasses	24	35	61	76	67	+ 52	+ 43
Dicotyledons	52	41	79	139	198	+ 87	+146
Bryophytes	14	17	7	10	5	- 4	- 9
Sedges	46	38	29	2	44	- 42	- 2
Debris	54	84	84	80	97	+ 26	+ 43
TOTAL	190	215	260	307	411	+165-46	+232-11
AREA 7							
Grasses	32	28	52	34	54	+ 2	+ 22
Dicotyledons	7	14	22	27	33	+ 20	+ 26
Bryophytes	90	53	85	72	73	- 18	- 17
Sedges	57	43	46	44	64	- 13	+ 7
Debris	200	108	101	71	83	-129	-117
TOTAL	386	246	306	248	307	+22-160	+55-134
AREA 8							
Grasses	45	44	58	56	62	+ 11	+ 17
Dicotyledons	3	3	9	3	3	0	0
Bryophytes	47	41	90	135	132	+ 88	+ 85
Sedges	13	9	11	16	22	+ 3	+ 9
Debris	140	141	215	101	185	- 39	+ 45
TOTAL	248	238	383	311	404	+102-39	+156

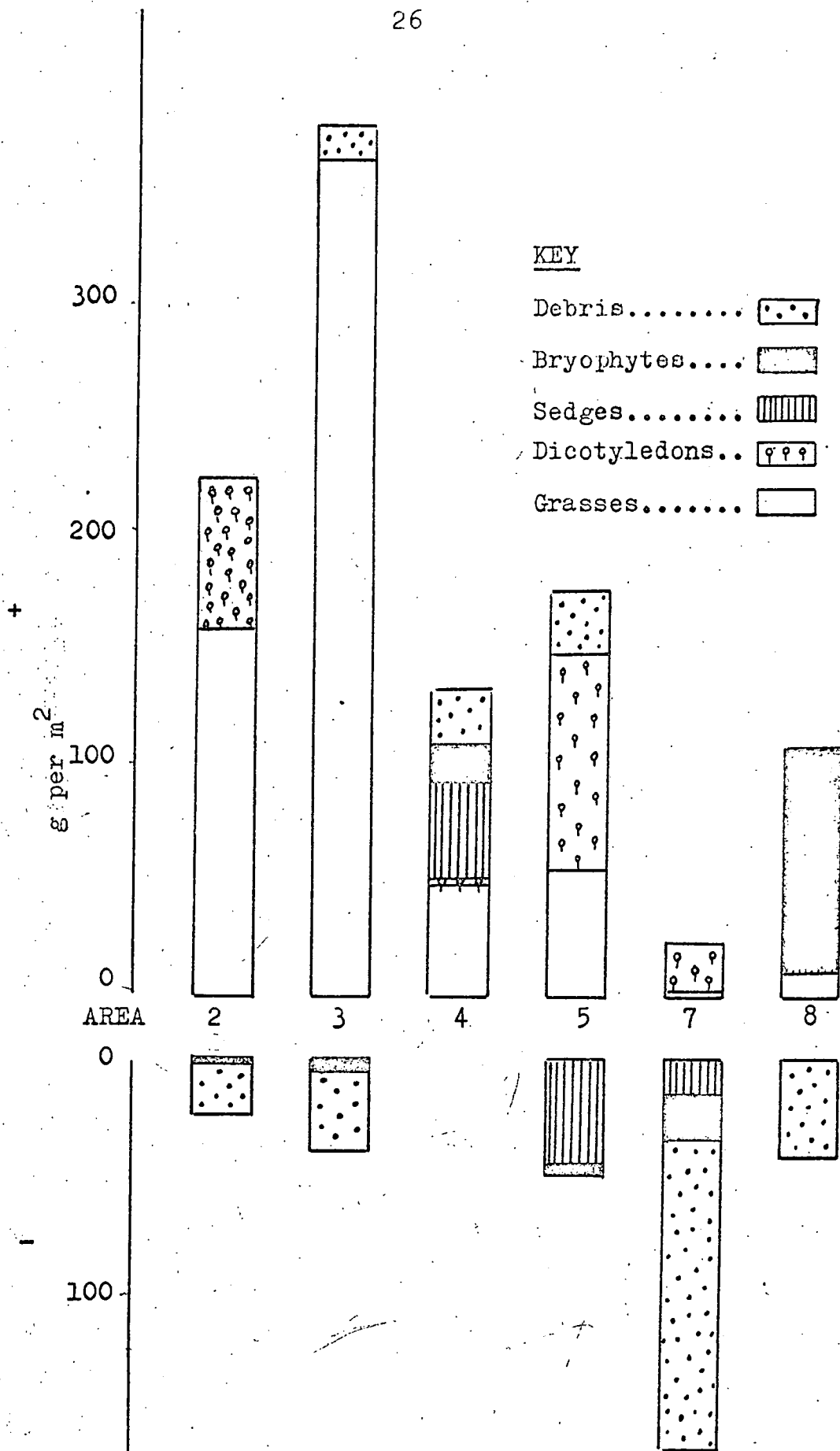

FIGURE 7 Change in dry weight (g per m²) of each component group of plants during the study period. (see Table 2)

TABLE 3

Mean Dry Weight per Plant at each Sample Time (mg)

Species	<u>24.5.68</u>	<u>7.6.68</u>	<u>21.6.68</u>	<u>11.7.68</u>	
Anthoxanthum odoratum	33.5	17.0		35.9	B
Holcus lanatus	6.3	8.8	35.6	63.6	⊖
Poa trivialis	6.4	6.0	10.9	5.8	⊖
Alopecurus pratensis	11.4	22.2	66.9	54.8	⊖
Agrostis tenuis	6.5	11.0	15.8	26.1	⊖
Festuca rubra	7.4	4.6	6.9	6.9	⊖
Bromus mollis	14.1	20.4	49.7	22.6	⊖
Cerastium holostæodes	6.5	10.2	66.4	23.2	⊖
Ranunculus bulbosus	90.1	113.0	121.2	190.7	⊖
Rumex acetosa	27.9	34.6	293.2	133.3	⊖
Conopodium majus	17.6	18.0	158.1		⊖
Trifolium repens	24.8	26.5		60.3	⊖
Rhinanthus minor		44.4	538.0	279.3	⊖
Helictotrichon pubescens	18.9		58.0	40.1	⊖
Holcus lanatus	9.4		35.8	363.8	⊖
Poa trivialis	5.6	5.7	12.5	7.0	⊖
Alopecurus pratensis	7.6	17.8	43.2	193.9	⊖
Festuca rubra	4.4	4.3	8.3	12.6	⊖
Bromus mollis	12.1	20.9	23.5	13.5	⊖
Cerastium holostæodes	8.7	12.1	37.6	24.7	⊖
Ranunculus bulbosus	238.6	266.3	158.7	49.3	E
Rumex acetosa	15.0	50.7	176.9	28.8	⊖
Conopodium majus	17.8	19.6	158.8		⊖
Rhinanthus minor	15.7	62.2	185.9	294.4	⊖
Achillea millefolium	39.8	78.0	210.2		⊖
Agrostis canina	25.2		13.2	0.5	E
Molinia caerulea	9.2	10.8	14.0	34.3	⊖
Eriophorum angustifolium	83.9	96.2	118.6	100.9	⊖
Carex pulicaris	19.9	14.1	19.9	6.2	B
Carex panicea	41.0	40.1	63.1	115.7	⊖
Carex pilulifera		12.0	43.8	5.3	⊖
Potentilla erecta	16.7	11.9		4.4	E

TABLE 3 contd.

	Species	24.5	7.6	21.6	11.7	5.8	
	<i>Helictotrichon pubescens</i>	39.5		29.2	36.6	35.5	B
	<i>Anthoxanthum odoratum</i>	7.5	7.7	21.2	24.8	20.0	*
	<i>Holcus lanatus</i>	3.7	6.2	9.3	18.1	11.9	*
	<i>Poa trivialis</i>	2.2	3.9	7.9	3.6	3.4	*
	<i>Poa pratensis</i>	11.2	12.9	31.9	10.4	18.8	*
	<i>Festuca rubra</i>	4.0	5.0	4.7	5.7	8.4	
	<i>Cynosurus cristatus</i>		7.6	19.5	23.3	19.4	*
	<i>Carex caryophylllea</i>	33.1	26.7	20.0		31.9	B
	<i>Luzula campestris</i>	20.9	35.1	38.1	33.9	19.4	*
	<i>Cerastium holostæodes</i>	17.2	13.3	10.3	4.4	8.3	E
	<i>Ranunculus bulbosus</i>	13.8	19.6	34.6	58.6	21.8	*
	<i>Rumex acetosa</i>	9.6	15.0	31.7	17.2	55.9	L
	<i>Trifolium repens</i>	16.7	21.9	34.4	48.0	32.0	*
	<i>Rhinanthus minor</i>	2.6	7.0	6.1	105.8	57.5	*
Area 5	<i>Succisa pratensis</i>	99.5		10.7	151.1		B
	<i>Anemone nemorosa</i>	49.6	46.2	41.0		36.0	E
	<i>Taraxacum paludosum</i>	12.1	6.2		166.0		*
	<i>Plantage lanceolata</i>	24.1	24.6	52.4	57.5	94.1	*
	<i>Centaurea nigra</i>	7.1	17.8	72.6	144.3	501.6	L
	<i>Leontodon hispidus</i>	23.6	23.6	24.6		253.5	L
	<i>Leontodon autumnalis</i>	17.8	40.1		50.9	89.2	L
	<i>Trollius europæus</i>	304.7	48.5		15.6	7.0	E
	<i>Potentilla erecta</i>		13.7	19.2		18.9	*
		<i>Euphrasia sp.</i>			13.1	16.1	25.2
Area 7	<i>Anthoxanthum odoratum</i>	10.0	10.0	10.5	12.0	14.5	L
	<i>Holcus lanatus</i>		6.1	8.2	13.0	7.8	*
	<i>Agrostis tenuis</i>	5.5			11.0	15.2	L
	<i>Festuca rubra</i>	5.7	3.7	6.7	4.1	8.2	
	<i>Molinia caerulea</i>	11.2	9.2			37.7	B
	<i>Agrostis canina</i>	4.2	2.9	5.3	3.4	6.1	
	<i>Festuca ovina</i>	3.7	2.3		13.3		
	<i>Briza media</i>		7.6	8.8	5.6		
	<i>Nardus stricta</i>	10.4	11.0	15.9	14.8	13.2	*

TABLE 3 contd.

		24.5	7.5	21.6	11.7	5.8	
Area 7 contd.	Species						
	Carex pulicaris	27.6			56.8	3.9	E
	Carex panicea	26.3	28.8	32.0	39.0	58.2	L
	Luzula campestris	11.6	20.7	22.1	22.1	9.4	*
	Potentilla erecta	24.8	19.2	41.8	19.6	21.9	*
	Galium saxatile	3.3	2.9	2.4		1.0	E
	Viola palustris	14.8	12.8		18.7		
	Trifolium repens			12.6	17.6	3.2	
	Anthoxanthum odoratum	13.1	10.0	8.2	9.2	12.7	B
	Holcus lanatus	6.0	6.6	22.1	10.4	7.1	*
Poa trivialis	4.5		3.1	3.1	0.8	E	
Poa pratensis	19.3	50.5	16.3				
Festuca fubra	6.2	5.1	8.3	3.6	8.3		
Molinia caerulea	21.4	18.2	15.7	14.3	25.6	B	
Agrostis canina	3.6	5.7	3.6		5.4		
Festuca ovina	4.1	0.6	2.3	3.9	4.6		
Briza media			10.6	7.4	103.3	L	
Nardus stricta	9.0	10.5	18.0	14.9	12.3	*	
Eriophorum angustifolium	45.2	41.8	32.3	67.4		B	
Carex pulicaris	15.1	14.1	9.9	7.5		E	
Carex panicea	27.5	40.5	42.2	49.4	63.3	L	
Juncus squarrosus	114.0	68.5	73.9	54.0	122.9	B	
Juncus articulatus	54.3		68.9	159.3	100.0	*	
Carex lepidocarpa		42.3	31.3		53.0	B	
Luzula campestris			19.9	18.7	20.2		
Area 8	Cerastium holostæodes	24.5		20.3	4.8	2.1	E
	Ranunculus bulbosus	44.2	26.7	44.8	75.0	98.9	B
	Cardamine flexuosa	24.6	18.3	24.5		3.2	E
	Ranunculus flammula	35.1	72.9			55.9	
	Campanula rotundifolia		31.9	0.1		2.3	E
	Trifolium repens		13.3	26.3	27.4	34.6	L
	Taraxacum paludosum		64.8	38.7	7.3		E
	Prunella vulgaris		29.2	50.1	72.3	95.3	L
	Potentilla erecta			19.8	15.8	14.2	E
	Leontodon autumnalis			70.2	142.6	47.5	*

TABLE 4

Dry Weight per square metre at each Sample Time of
Each Species (g per m²)

<u>Area & Species</u>	<u>24.5.68</u>	<u>7.6.68</u>	<u>21.6.68</u>	<u>11.7.68</u>	
Anthoxanthum odoratum	3.6	1.8		3.9	B
Holcus lanatus	8.2	11.5	46.6	83.2	⊗
Poa trivialis	14.2	13.2	24.1	12.8	⊗
Alopecurus pratensis	8.1	15.7	38.7	47.3	⊗
Agrostis tenuis	6.2	13.5	15.3	25.1	⊗
Festuca rubra	9.7	6.1	9.1	9.1	
Bromus mollis	7.1	10.3	25.0	11.4	⊗
Cerastium holostéodes	2.2	3.4	22.2	7.7	⊗
Ranunculus bulbosus	7.9	9.9	10.7	16.8	⊗
Rumex acetosa	3.8	4.7	39.9	18.1	⊗
Conopodium majus	3.4	3.4	30.3		⊗
Trifolium repens	6.4	6.8		15.5	⊗
Rhinanthus minor		1.9	23.2	12.0	⊗
Debris	76.0	64.0	46.0	58.0	
other species		6.4	7.0	24.4	
Bryophytes	3.0	2.0		1.0	E
TOTAL	158	117	338	346	
Helictotrichon pubescens	6.5		20.1	13.9	⊗
Holcus lanatus	3.2		12.1	122.9	⊗
Poa trivialis	8.3	10.0	21.6	12.2	⊗
Alopecurus pratensis	6.1	14.3	34.8	156.1	⊗
Festuca rubra	26.9	26.5	50.9	77.6	⊗
Bromus mollis	15.1	25.9	29.2	16.7	⊗
Cerastium holostéodes	2.2	2.3	10.0	6.6	⊗
Ranunculus bulbosus	15.8	17.6	10.5	3.3	E
Rumex acetosa	2.1	7.2	25.2	4.1	⊗
Conopodium majus	1.6	1.8	14.2		⊗
Rhinanthus minor	1.0	4.0	11.8	18.7	⊗
Achillea millefolium	1.4	2.7	7.2		⊗

TABLE 4 contd.

<u>Area & Species</u>		<u>24.5.68</u>	<u>7.6.68</u>	<u>21.6.68</u>	<u>11.7.68</u>		
other species		1.6	0.7	16.2	13.6		
Bryophytes		6.0	4.0	2.0		E	
Debris		93.0	98.0	103.0	60.0		
TOTAL		191	213	368	508		
Area 4	<i>Agrostis canina</i>	0.8		0.4	+	E	
	<i>Molinia caerulea</i>	16.7	19.6	25.3	62.3	*	
	<i>Eriophorum angustifolium</i>	34.1	39.1	48.2	41.1	*	
	<i>Carex pulicaris</i>	5.8	4.1	5.8	1.8	B	
	<i>Carex panicea</i>	14.4	14.1	22.1	40.6	*	
	<i>Carex pilulifera</i>		0.6	2.3	0.3	*	
	<i>Potentilla erecta</i>	0.7	0.5		0.2	E	
	other species	0.5	1.3	11.2	14.4		
	Debris	115.0	87.0	181.0	137.0		
	Bryophytes	5.0	2.0	1.0	19.0	*	
TOTAL		193	169	294	317		
Area 5		<u>24.5</u>	<u>7.6</u>	<u>21.6</u>	<u>11.7</u>	<u>5.8</u>	
	<i>Helictotrichon pubescens</i>	2.8		2.0	2.5	2.5	B
	<i>Anthoxanthum odoratum</i>	3.0	3.1	8.6	9.9	8.1	*
	<i>Holcus lanatus</i>	3.0	5.1	7.7	14.9	9.8	*
	<i>Poa trivialis</i>	1.9	3.9	6.8	3.1	2.9	*
	<i>Poa pratensis</i>	1.3	1.5	3.7	1.2	2.2	*
	<i>Festuca rubra</i>	11.8	14.5	13.9	16.8	24.7	
	<i>Cynosurus cristatus</i>		7.1	18.0	21.6	17.9	*
	<i>Carex caryophyllea</i>	44.9	36.2	27.1		43.2	B
	<i>Luzula campestris</i>	1.2	2.1	2.2	2.0	1.1	*
<i>Cerastium holostoides</i>	3.1	2.4	1.8	0.7	1.5	E	
<i>Ranunculus bulbosus</i>	4.6	6.5	11.5	19.4	7.2	*	
<i>Rumex acetosa</i>	0.7	1.2	2.4	1.3	4.3	L	
<i>Trifolium repens</i>	3.0	3.9	6.1	8.5	5.7	*	

TABLE 4 contd.

<u>Area & Species</u>	<u>24.5</u>	<u>7.6</u>	<u>21.6</u>	<u>11.7</u>	<u>5.8</u>	
Rhinanthus minor	1.0	2.7	2.4	40.7	22.1	*
Succisa pratensis	0.7		0.1	1.1		B
Anemone nemorosa	2.0	1.8	1.6		1.4	E
Taraxacum paludosum	0.4	0.2		4.8		*
Plantago lanceolata	17.4	17.8	37.8	42.4	67.9	*
Centaurea nigra	0.8	2.0	8.0	15.8	55.1	L
Leontodon hispidus	0.5	0.5	0.8		5.3	L
Leontodon autumnalis	0.3	0.8		1.0	1.7	L
Trollius europaeus	17.5	2.8		0.9	0.4	E
Potentilla erecta		0.7	1.0		1.0	*
Euphrasia sp.			2.1	2.6	4.1	L
other species	0.1	0.9	4.0	1.3	9.9	
Debris	53.0	84.0	84.0	80.0	97.0	
Bryophytes	14.0	17.0	7.0	10.0	5.0	E
TOTAL	190	215	260	377	411	
Anthoxanthum odoratum	2.8	2.9	3.0	3.1	3.4	L
Holcus lanatus		0.8	1.0	1.6	1.0	*
Agrostis tenuis	1.0			2.0	2.8	L
Festuca rubra	2.0	1.3	2.4	1.5	2.9	
Molinia caerulea	2.4	1.9			7.9	B
Agrostis canina	5.3	3.7	6.7	4.4	7.8	
Festuca ovina	3.0	1.8		2.6		
Briza media		1.9	2.2	1.4		
Nardus stricta	28.3	30.1	43.5	40.5	36.2	*
Carex pulicaris	5.6			1.4	1.2	E
Carex panicea	6.5	7.1	7.9	9.7	14.4	L
Luzula campestris	0.4	0.7	0.8	0.8	0.3	*
Potentilla erecta	1.8	1.4	3.1	1.4	1.6	*
Galium saxatile	1.0	0.8	0.7		0.3	E
Viola palustris	0.6	0.5			0.7	
Trifolium repens			0.8	1.1	0.2	
other species	0.4	0.4	5.6	5.0	7.6	

TABLE 4 contd.

<u>Area & Species</u>	<u>24.5</u>	<u>7.6</u>	<u>21.6</u>	<u>11.7</u>	<u>5.8</u>	
Bryophytes	47.0	41.0	90.0	135.0	132.0	
Debris	140.0	141.0	215.0	101.0	185.0	
TOTAL	248	238	383	311	404	
Anthoxanthum odoratum	4.2	3.2	2.6	2.9	4.0	B
Holcus lanatus	4.7	5.2	17.2	8.1	5.5	*
Poa trivialis	0.8			0.5	0.1	E
Poa pratensis	0.7	1.9	1.3			
Festuca rubra	6.3	5.1	8.3	3.6	8.3	
Molinia caerulea	2.5	2.1	1.8	1.6	2.9	B
Agrostis canina	2.2	3.5	2.2		3.3	
Festuca ovina	4.5	0.7	3.5	4.3	5.1	B
Briza media			1.6	1.1	16.0	L
Nardus stricta	6.0	7.1	12.1	10.0	8.3	*
Eriophorum angustifolium	2.6	2.4	1.9	3.9		B
Carex pulicaris	5.2	4.9	3.4	2.6		E
Carex panicea	6.5	9.6	10.0	11.7	15.0	L
Juncus squarrosus	40.2	24.2	26.1	19.1	43.4	B
Juncus articulatus	2.2		2.8	6.5	4.1	*
Carex lepidocarpa		1.0	0.7		1.2	B
Luzula campestris			0.7	0.6	0.7	
Cerastium holostèodes	0.4		0.3	0.1	+	B
Ranunculus bulbosus	4.9	3.0	5.0	8.4	11.0	*
Cardamine flexuosa	1.1	0.8	1.1		0.1	B
Ranunculus flammula	0.9	1.9			1.5	
Campanula rotundifolia		0.2	+		+	E
Trifolium repens		4.2	8.3	8.7	11.0	L
Taraxacum paludosum		2.0	1.2	0.2		E
Prunella vulgaris		2.0	3.5	5.0	6.6	L
Potentilla erecta			0.8	0.6	0.6	E
Leontodon autumnalis			1.7	3.4	1.1	*
other species	0.6	2.2	2.7	0.4	1.1	
Bryophytes	90.0	53.0	86.0	72.0	73.0	E
Debris	200.0	108.0	101.0	71.0	83.0	
TOTAL	386	245	306	248	307	

Area 8

TABLE 5

Bryophyte Dry Weight at each Sample Time
g per m² per species.

<u>Area and Species</u>	24.5	7.6	21.6	11.7	5.8	
Area 2						
Brachythecium rutabulum	0.8	0.5		0.2		E
Eurynchium swartzii	2.3	1.1		0.5		E
TOTAL	3.1	1.6		0.7		
Area 3						
Acrocladium cuspidatum				+		
Mnium punctatum	+					
Brachythecium rutabulum	1.6	0.5	2.2	0.3		B
Eurynchium swartzii	3.8	4.0	0.2			E
Rhytidiadelphus squarrosus	0.4			+		E
TOTAL	5.8	4.5	2.4	0.3		
Area 4						
Acrocladium cuspidatum		0.7	1.0	19.0		*
Pseudoscleropodium purum				+		
Rhytidiadelphus squarrosus	2.0	0.2				
Hylocomium splendens	2.5	0.7				E
Lophocolea bidentata	0.4					
Brachythecium rutabulum				+		
Calypogeia trichomanis				0.3		
TOTAL	4.9	1.6	1.0	19.3		
Area 5						
Acrocladium cuspidatum	4.1	8.0	0.3	2.1	1.2	E
Mnium punctatum		0.9	+	0.5		E
Thuidium tamariscinum		4.3				
Mnium undulatum	2.5	0.3		0.4	1.7	B
Brachythecium rutabulum	7.0	3.1	0.4	5.8		B
Eurynchium swartzii	0.4		1.7	7.8	1.9	*
Rhytidiadelphus squarrosus			2.7			
Pseudoscleropodium purum				+		

TABLE 5 contd.

<u>Area and Species</u>	24.5	7.6.	21.6	11.7	5.8	
Area 5 contd.						
Lophocolea bidentata	0.1		2.1		0.3	
Calypogeia trichomanis		0.3	0.1			
Scapania undulata		0.2				
TOTAL	14.1	17.1	7.4	10.1	5.1	
Area 7						
Acrocladium cuspidatum	50.2	46.1	57.5	6.2	51.8	
Aulocomnium palustre				34.5		
Mnium punctatum	0.3	0.7			+	
Mnium undulatum		0.4	8.3	8.3	0.8	*
Thuidium tamariscinum			2.6	1.5	2.8	
Brachythecium rutabulum	1.8	0.8	2.1		0.6	
Eurynchium swartzii	5.6	0.3	0.7	0.3		E
Pleurozium schreberi	27.5					
Hypnum cupressiforme	3.9	0.2			0.6	E
Rhytidiadelphus squarrosus		0.5	11.3	9.5	10.7	
Hylocomium splendens			0.6	6.8	4.1	*
Philonotis fontana		1.4		+		
Thuidium delicatulum		1.3	0.2	0.9	+	
Pseudoscleropodium purum			2.6	0.6	1.0	
Fissidens sp.			0.3			
Dicranum scoparium				3.8		
Riccardia pinguis					0.3	
Lophocolea bidentata		0.2	0.2	0.1	+	
Calypogeia trichomanis	0.6	1.3				
Scapania undulata		0.1				
TOTAL	89.9	53.3	86.3	72.5	72.8	
Area 8						
Acrocladium cuspidatum			47.7	37.1	0.6	E
Aulocomnium palustre	3.2	2.7		60.3	11.2	*
Pseudoscleropodium purum		0.8	24.0	1.6	6.2	
Mnium punctatum		0.7		13.8	4.0	
Mnium undulatum			1.2		0.2	

TABLE 5 contd.

<u>Area and Species</u>	24.5	7.6	21.6	11.7	5.8	
Area 8 contd.						
Thuidium tamariscinum	18.2	8.0	5.1	3.1	17.1	B
Brachythecium rutabulum			1.0			
Pleurozium schreberi	1.0	0.4				
Hypnum cupressiforme	7.9	4.3	2.8			
Rhytidiadelphus squarrosus	3.4	10.0	4.2		76.5	
Hylocomium splendens	2.3	3.6	2.9	3.5	10.6	L
Dicranum scoparium		1.1		1.4	0.6	
Polytrichum commune	0.3	2.6			4.0	
Climacium dendroides				5.8		
Riccardia pinguis		0.1		1.6	+	
Lophocolea bidentata	1.2	7.6	0.8	1.8	0.3	
Calypogeia trichomanis		0.1		+	0.7	L
Scapania undulata		0.3				
Thallose liverwort				5.3		
TOTAL	47.5	37.7	89.8	135.4	132.3	

areas 7 and 8, also abundant in areas 7 were Holcus lanatus, Festuca rubra and Trifolium repens, and in area 8 Galium saxatile. Molinia caerulea was common only in area 4.

The majority of species studied can be regarded as "conformist", that is they show the expected increase in dry weight over the study period, all these species are marked by an asterisk in Tables 3, 4 and 5. All those marked E would appear to have their main period of development in the spring and over the study period show a continuous decrease in dry weight. These include the Bryophytes, except at area 8, spring flowers, e.g. Anemone nemorosa and Cerastium holostæodes, and the montane species Trollius europæus. In the arctic-alpine communities of the upper dale Trollius europæus develops almost a month later (pers. comm. C. Marshall). "Late-developers", marked L, include Leontodon spp., Carex panicea and Centaurea nigra. A number of species, marked B, show an early and a late peak. These include the Carices, like Carex lepidocarpa and Carex caryophyllea, also Juncus squarrosus and Molinia caerulea. This raised a problem of interpretation of results when dealing with species which are biennial-perennials. That is species which produce vegetative tillers in the first year that overwinter and flower in the second year (Rieley 1967). When cropping it is often difficult to distinguish between the two types of shoots. Mixtures of the two types of shoots are probably responsible for the bimodal type of curve under discussion. It is also obvious that in perennials which produce their new shoots (i.e. next year shoots) in the late summer or which store food in some above ground part (e.g. Molinia caerulea stores nutrients in the basal internode—Loach 1968, Jeffries 1915), other difficulties will be encountered unless great care is taken during sorting. Taking all

these points into consideration a series of production figures were calculated from Tables 2 and 4 using the following methods.

(A) Taking the actual overall increase in standing crop (including debris) during the experimental period, i.e. differences between first and last standing crop figures.

(B) Adding the peak standing crop of each species and subtracting from this the minimum dry weight of each species.

(C) Adding to the figures from (B) the difference between maximum and minimum dry weight of debris during the season, as this must represent a season's litter fall.

(D) Using the peak standing crop of each component group of plants, including the season's litter, rather than the final standing crop, and subtracting the minimum standing crops.

The results are shown in Tables 6(A) and 6(B).

A study of the changes in biomass of individual species easily explains the results of Table 6 and also of Table 2. The total grass dry weight increases in all areas up to the time of mowing. Bromus mollis, Poa trivialis and Helictotrichon pubescens in the hay meadow, being early summer grasses, showed a decrease before cutting, but this loss was compensated for by the continued increase of Holcus lanatus, Alopecurus pratensis, Agrostis tenuis and also by Festuca rubra in area 3. Most of the dicotyledons in areas 2 and 3 had finished flowering by the end of June and this explained the decrease in total dicotyledon dry weight between 21.6.68 and 11.7.68 (Table 2).

The fact that different species attained their peak dry weight at different times easily explains why

TABLE 6A(i)

Production Figures calculated by the Four Methods A, B, C and D, of the Communities between 24.5.68 and 11.7.68 (48 days) in g per m² (see Fig.83).

AREA	METHOD			
	A	B	C	D
2	188	315	344	283
3	217	460	503	446
4	123	125	273	196
5	119	206	242	234
7	-138	136	275	224
8	63	130	244	235

TABLE 6A(ii)

Production Figures of Areas 5, 7 and 8 between 24.5.68 and 5.8.68 (73 days)

AREA	METHOD			
	A	B	C	D
5	221	284	327	308
7	-79	156	285	239
8	156	150	264	245

TABLE 6B(i)

Rate of Production calculated by the Four Methods A, B, C and D, of the Communities between 24.5.68 and 11.7.68 (48 days) in g per m² per day.

AREA	METHOD			
	A	B	C	D
2	3.9	6.6	7.2	5.9
3	4.5	9.6	10.5	9.3
4	2.6	2.6	5.7	4.1
5	2.5	4.3	5.0	4.9
7	-2.9	2.8	5.7	4.7
8	1.3	2.7	5.1	4.9

TABLE 6B(ii)

Rate of Production of Areas 5, 7 and 8 between 24.5.68 and 5.8.68 (73 days)

AREA	METHOD			
	A	B	C	D
5	3.0	3.9	4.5	4.2
7	-1.1	2.1	3.9	3.3
8	2.1	2.0	3.6	3.5

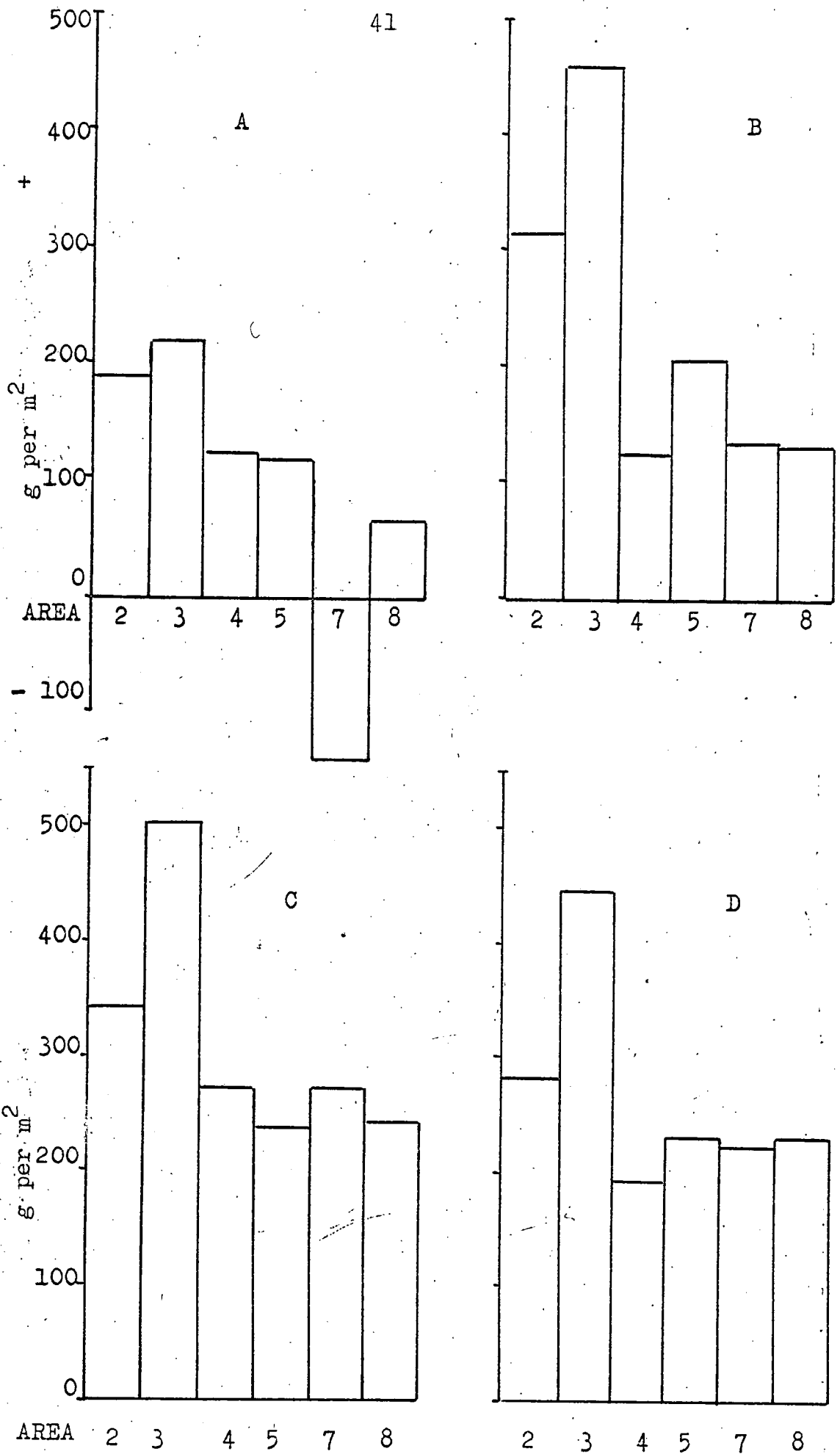

FIGURE 8 Production ($g \text{ per } m^2$) at the six study areas as calculated by 4 different methods-A, B, C, & D. (see Table 6A(i))

production as calculated by methods (B), (C) and (D) usually exceeds that by method (A), and again shows that the more detailed the cropping programme and analysis the more meaningful the production figures will be.

The much higher final increase in biomass of certain species at area 3, (e.g. Holcus lanatus), than at area 2, is reflected in the higher production figures. All methods show that area 3 is the most productive area studied.

As calculated by methods (C) and (D) (Table 6A(i) and B(i)), production of areas 4, 5, 7 and 8 are very similar, but comparison of results of methods (B) and (C) indicates that in the wet, more natural areas, i.e. areas 4, 7 and 8 which are never mown, nearly half of this production passes rapidly to the litter. The majority of plants from areas 4, 7 and 8 have thick cuticles and would decay only slowly, the wet conditions also hindering decay. At area 7 the large decrease in litter biomass during the study period explains the negative production figure as calculated by method (A). Here, litter accumulates when the plants die in the autumn. The total litter in areas 4, 5 and 8 tends to increase then decrease. The presence of many dicotyledons growing at different times of the year explains why production at area 5 as calculated by method (B) was higher than at areas 4, 7 and 8. The low figure for area 8, as calculated by method (A), could be due to the fact that here the Bryophytes are the dominant group of plants, and the most productive ones. Thus even though the communities may be different and different groups of plants may be important, the total production may be the same, depending on the method of calculation.

Tables 6B(ii) and A(ii) show that by extending the

experimental period a slightly different picture is obtained. The production ($\text{g/m}^2/\text{day}$) as calculated by methods (B), (C) and (D) has decreased and by method (A) has increased, as compared with the results in Tables 6A(i) and B(i). This could indicate that the last sample was taken when the growing season was nearly finished, the growth rate of the plants decreasing and the rate of accumulation of litter increasing.

Table 7 shows the biomass of all the major component species expressed as percentage of the maximum total above ground living organic matter attained at any of the areas (area 3, 11, 7, 68). This simply allows comparison of the role of each species in the vegetation complex, i.e. a direct comparative measure of "cover" as biomass. Holcus lanatus and Alopecurus pratensis formed the largest part of the hay meadow communities, Plantago lanceolata and Centaurea nigra at area 5, Molinia caerulea area 4, and the Bryophytes at areas 7 and 8. The most important species, from the point of view of standing crop for fodder, can therefore be identified for each cropping time and a crude "production phenology" can be built up in this way. It is suggested that such information could be of use in the planning of new seed mixtures for improving these areas by reseeding, and of determining the best time for mowing.

Table 8 shows the percentage increase in dry weight of each species, allowing the species with the optimum potential development in each community to be picked out. Species showing definite "preference", estimated as maximum performance during the study period, for each area are listed below:-

<u>AREA 2</u>	Agrostis tenuis
	Bromus mollis

TABLE 7

Dry Weight of each Species expressed as a Percentage of 447--the Maximum Total Dry Weight of Living Material Found (11.7.68, Area 3)

<u>Area & Species</u>	<u>Date</u>				
Area 2	24.5	7.6	21.6	11.7	5.8
Holcus lanatus	1.8	2.6	10.5	18.7	
Alopecurus pratensis	1.8	3.5	8.7	10.6	
Conopodium majus	0.8	0.8		6.8	
Agrostis tenuis	1.4	3.0	3.4	5.6	
Rumex acetosa	0.8	1.1	0.0	4.1	
Ranunculus bulbosus	1.8	2.2	2.4	3.8	
Trifolium repens	1.4	1.5		3.5	
Poa trivialis	3.2	3.0	5.4	2.9	
Rhinanthus minor		0.4	5.2	2.7	
Bromus mollis	1.6	2.3	5.6	2.6	
Festuca rubra	2.2	1.4	2.0	2.0	
Cerastium holostæodes	0.5	0.8	5.0	1.7	
Anthoxanthum odoratum	0.8	0.4		0.9	
Bryophytes	0.7	0.4		0.2	
other species		1.4	1.6	5.5	
TOTAL	18.7	25.3	65.6	64.9	
Area 3					
Alopecurus pratensis	1.4	3.2	7.8	35.0	
Holcus lanatus	0.7		2.7	27.6	
Festuca rubra	6.0	5.9	11.4	17.4	
Rhinanthus minor	0.2	0.9	2.7	4.2	
Bromus mollis	3.4	5.8	6.6	3.7	
Rumex acetosa	0.5	1.6	5.7	0.9	
Ranunculus bulbosus	3.5	4.0	2.4	0.7	
Conopodium majus	0.4	0.4	3.2		
Helictotrichon pubescens	1.5		4.5	3.1	

TABLE 7 contd.

<u>Area & Species</u>	24.5	7.6	21.6	11.7	5.8
Area 3 contd.					
Poa trivialis	1.9	2.2	4.8	2.7	
Achillea millefolium	0.3	0.6	1.6		
Cerastium holostéodes	0.5	0.5	2.2	1.5	
Bryophytes	1.3	0.9	0.4		
other species	0.4	0.2	3.6	3.1	
TOTAL	22.0	26.0	60.0	100.0	
Area 4					
Molinia caerulea	3.7	4.4	5.7	13.9	
Eriophorum angustifolium	7.6	8.7	10.8	9.2	
Carex panicea	3.2	3.1	4.9	9.1	
Bryophytes	1.1	0.5	0.2	4.3	
Carex pulicaris	1.3	0.9	1.3	0.4	
Carex pilulifera		0.1	0.5	0.1	
Potentilla erecta	0.2	0.1		0.1	
Agrostis canina	0.2		0.1		
other species	0.1	0.3	2.5	3.2	
TOTAL	17.4	18.3	25.2	40.2	
Area 5					
Plantago lanceolata	3.9	4.0	8.4	9.5	25.2
Carex nigra	0.2	0.5	1.8	3.5	12.3
Carex caryophyllea	10.0	8.1	6.1		9.7
Festuca rubra	2.6	3.2	3.1	3.7	5.5
Rhinanthus minor	0.2	0.6	0.5	9.1	4.9
Cynosurus cristatus		1.6	4.0	4.8	4.0
Holcus lanatus	0.7	1.1	1.7	3.3	2.2
Anthoxanthum odoratum	0.7	0.7	1.9	2.2	1.8
Ranunculus bulbosus	1.0	1.4	2.6	4.3	1.6
Trifolium repens	0.7	0.9	1.4	1.9	1.3

TABLE 7 contd.

<u>Area & Species</u>	24.5	7.6	21.6	11.7	5.8
Area 5 contd.					
Leontodon hispidus	0.1	0.1	0.2		1.2
Taraxacum paludosum	0.1	+		1.1	
Bryophytes	3.1	3.8	1.6	2.2	1.1
Rumex acetosa	0.2	0.3	0.5	0.3	1.0
Euphrasia sp.			0.5	0.6	0.9
Poa trivialis	0.4	0.8	1.5	0.7	0.6
Helictotrichon pubescens	0.6		0.5	0.6	0.6
Poa pratensis	0.3	0.3	0.8	0.3	0.5
Leontodon autumnalis	0.1	0.2		0.2	0.4
Luzula campestris	0.3	0.5	0.5	0.5	0.3
Cerastium holostæodes	0.7	0.5	0.4	0.2	0.3
Anemone nemorosa	0.5	0.4	0.4		0.3
Succisa pratensis	0.2		+	0.2	
Potentilla erecta		0.2	0.2		0.2
Trollius europæus	3.9	0.6		0.2	0.1
other species	+	0.2	0.9	0.3	2.2
TOTAL	30.4	29.3	39.3	50.7	70.2
Area 7					
Bryophytes	20.1	11.9	19.2	16.1	16.3
Juncus squarrosus	9.0	5.4	5.8	4.3	9.7
Briza media			0.4	0.2	3.6
Carex panicea	1.4	2.1	2.2	2.6	3.4
Juncus bulbosus	1.1	0.7	1.1	1.9	2.5
Trifolium repens		0.9	1.9	1.9	2.5
Festuca rubra	1.4	1.1	1.9	0.8	1.9
Nardus stricta	1.3	1.6	2.7	2.2	1.9
Prunella vulgaris		0.5	0.8	1.1	1.5
Holcus lanatus	1.0	1.2	3.8	1.8	1.2
Festuca ovina	1.0	0.2	0.6	0.9	1.1
Anthoxanthum odoratum	0.9	0.7	0.6	0.6	0.9
Eriophorum angustifolium	0.6	0.5	0.4	0.9	

TABLE 7 contd.

<u>Area & Species</u>	24.5	7.6	21.6	11.7	5.8
Area 7 contd.					
<i>Juncus articulatus</i>	0.5		0.6	1.5	0.9
<i>Agrostis canina</i>	0.5	0.8	0.5		0.7
<i>Molinia caerulea</i>	0.6	0.5	0.4	0.4	0.6
<i>Carex pulicaris</i>	1.2	1.1	0.8	0.6	
<i>Carex lepidocarpa</i>		0.2	0.2		0.3
<i>Ranunculus flammula</i>	0.2	0.4			0.3
<i>Leontodon autumnalis</i>			0.4	0.8	0.3
<i>Poa pratensis</i>	0.2	0.4	0.3		
<i>Luzula campestris</i>			0.2	0.2	0.2
<i>Potentilla erecta</i>			0.2	0.2	0.2
<i>Poa trivialis</i>	0.2			0.1	+
<i>Cerastium holostéodes</i>	0.1		0.1	+	+
<i>Cardamine flexuosa</i>	0.2	0.2	0.2		+
<i>Campanula rotundifolia</i>		+	+		+
<i>Viola palustris</i>		0.5	0.3	+	
other species	0.2	0.5	0.6	0.1	0.2
TOTAL	41.6	72.4	45.8	39.5	50.1
Area 8					
Bryophytes	10.5	9.2	20.1	30.2	30.1
<i>Nardus stricta</i>	6.3	6.7	9.7	9.1	8.1
<i>Carex panicea</i>	1.5	1.6	1.8	2.2	3.2
<i>Agrostis canina</i>	1.2	0.8	1.5		1.8
<i>Molinia caerulea</i>	0.5	0.4			1.8
<i>Anthoxanthum odoratum</i>	0.6	0.6	0.7	0.7	0.8
<i>Agrostis tenuis</i>	0.2			0.5	0.6
<i>Festuca rubra</i>	0.5	0.3	0.5	0.3	0.6
<i>Festuca ovina</i>	0.7	0.4		0.6	
<i>Potentilla erecta</i>	0.4	0.3	0.7	0.3	0.4
<i>Briza media</i>		0.4	0.5	0.3	
<i>Carex pulicaris</i>	1.2			0.3	0.3
<i>Viola palustris</i>	0.2	0.1			0.2

TABLE 7 contd.

<u>Area & Species</u>	24.5	7.6	21.6	11.7	5.8
Area 8 contd.					
Holcus lanatus		0.2	0.2	0.4	0.2
Luzula campestris	0.1	0.2	0.2	0.2	0.1
Trifolium repens			0.2	0.2	+
Galium saxatile	0.2	0.2	0.2		0.1
other species	0.1	0.1	1.3	1.2	1.7
TOTAL	24.1	21.7	37.5	46.9	48.9

TABLE 8

PERCENTAGE INCREASE IN DRY WEIGHT OF EACH SPECIES

$$\left(\frac{\text{maximum dry weight} - \text{minimum dry weight}}{\text{minimum dry weight}} \right) \times 100$$

Species	Area 2	Area 3	Area 4	Area 5	Area 7	Area 8
<i>Anthoxanthum odoratum</i>	111			<u>228</u>	60	45
<i>Holcus lanatus</i>	909	<u>3933</u>		<u>350</u>	267	117
<i>Poa trivialis</i>	89	140		300	<u>463</u>	
<i>Alopecurus pratensis</i>	487	<u>2325</u>				
<i>Agrostis tenuis</i>	<u>301</u>					176
<i>Festuca rubra</i>	<u>240</u>	<u>186</u>		100	100	100
<i>Bromus mollis</i>	<u>257</u>	<u>93</u>				
<i>Helictotrichon pubescens</i>		<u>205</u>		33		
<i>Agrostis canina</i>			25		56	<u>100</u>
<i>Molinia caerulea</i>			278		86	<u>322</u>
<i>Poa pratensis</i>				220	213	
<i>Festuca ovina</i>					<u>583</u>	61
<i>Briza media</i>					<u>1371</u>	57
<i>Nardus stricta</i>					<u>100</u>	45
<i>Cynosurus cristatus</i>				187		
<i>Carex pilulifera</i>			780			
<i>Carex pulicaris</i>			235		100	<u>600</u>
<i>Carex panicea</i>			<u>190</u>		133	<u>123</u>
<i>Carex caryophylla</i>				65		
<i>Carex lepidocarpa</i>					71	
<i>Eriophorum angustifolium</i>			42		<u>109</u>	
<i>Juncus squarrosus</i>					128	
<i>Juncus articulatus</i>					194	
<i>Luzula campestris</i>				100	9	<u>134</u>
<i>Cerastium holostæodes</i>	1000	322		325	<u>1100</u>	
<i>Ranunculus bulbosus</i>	121	<u>443</u>		321	259	
<i>Rumex acetosa</i>	946	<u>1080</u>		460		
<i>Conopodium majus</i>	778	<u>783</u>				
<i>Trifolium repens</i>	140			182	170	<u>450</u>
<i>Rhinanthus minor</i>	1100	1738		<u>3433</u>		
<i>Achillea millefolium</i>		425				
<i>Potentilla erecta</i>			325	36	43	32
<i>Cardamine flexuosa</i>					733	
<i>Ranunculus flammula</i>					109	
<i>Campanula rotundifolia</i>					1500	
<i>Taraxacum paludosum</i>				<u>2666</u>	829	
<i>Prunella vulgaris</i>					228	
<i>Leontodon autumnalis</i>				<u>395</u>	204	
<i>Succisa pratensis</i>				1273		
<i>Anemone nemorosa</i>				31		
<i>Plantago lanceolata</i>				292		
<i>Centaurea nigra</i>				7071		
<i>Leontodon hispidus</i>				954		
<i>Trollius europæus</i>				4257		
<i>Euphrasia spp.</i>				169		
<i>Galium saxatile</i>						230
<i>Viola palustris</i>						46

<u>AREA 3</u>	Holcus lanatus Alopecurus pratensis Festuca rubra Helictotrichon pubescens Ranunculus bulbosus Rumex acetosa Conopodium majus
<u>AREA 4</u>	Carex panicea Potentilla erecta
<u>AREA 5</u>	Anthoxanthum odoratum Rhinanthus minor Taraxacum paludosum + other dicotyledons
<u>AREA 7</u>	Poa trivialis Festuca ovina Briza media Nardus stricta Eriophorum angustifolium Juncus spp. Cerastium holostæodes
<u>AREA 8</u>	Agrostis canina Molinia caerulea Carex pulicaris Luzula campestris Trifolium repens

Again, although only crude, these figures allow at least a statement to be made concerning the community which offers the best niche for the development of each species.

Table 9 shows the data expressed in another way. Here the maximum dry weight attained by each species in each area is shown, again helping to identify their best niche within the community complex. The optimum

TABLE 9 Showing the maximum average dry weight (mg per plant) attained by some species during the experimental period.

<u>SPECIES</u>	<u>AREA</u>					
	8	7	5	4	3	2
<u>Anthoxanthum odoratum</u>	14.5	13.1	24.6			25.9
Holcus lanatus	13.0	22.1	18.1		363.8	63.6
<u>Nardus stricta</u>	15.9	18.0				
Festuca rubra	11.4	8.3	8.4		12.6	7.4
Molinia caerulea	37.7	25.6		34.3		
<u>Poa trivialis</u>		4.5	7.9		12.5	18.6
<u>Carex panicea</u>	58.2	63.3		115.7		
Carex pulicaris	27.6	15.1		19.9		
<u>Eriophorum angustifolium</u>		67.4		118.6		
Rumex acetosa			55.9		176.9	293.2
Cerastium holostæodes			17.2		32.6	66.4
Ranunculus bulbosus		98.9	58.6		266.3	190.7
<u>Trifolium repens</u>	17.6	34.6	48.0			60.3
Rhinanthus minor			105.8		294.4	538.0

The underlined species attained a higher dry weight the lower they grew on the Fall Slope.

niche for these species as indicated by this method is only the same as by the previous method in the cases of the underlined species in the following list.

<u>AREA 2</u>	<u>Anthoxanthum odoratum</u> <u>Poa trivialis</u> <u>Rumex acetosa</u> <u>Cerastium holostæodes</u> <u>Trifolium repens</u> <u>Rhinanthus minor</u>
<u>AREA 3</u>	<u>Holcus lanatus</u> <u>Festuca rubra</u> <u>Ranunculus bulbosus</u>
<u>AREA 4</u>	<u>Carex panicea</u> <u>Eriophorum angustifolium</u>
<u>AREA 7</u>	<u>Nardus stricta</u>
<u>AREA 8</u>	<u>Molinia caerulea</u> <u>Carex pulicaris</u>

The percentage increase in dry weight is considered a better indication of performance than maximum dry weight. This table also shows that the maximum biomass of some species was higher, the lower they grew on the Fell slope, e.g. Carex panicea and Trifolium repens. Such species are underlined in Table 9.

This line of work was enlarged upon in the second year of the study. Exclosures were erected and the development of Holcus lanatus, Festuca rubra, Anthoxanthum odoratum, Rhinanthus minor and Trollius europæus was followed in detail over the growing season, both inside and outside the exclosures. The full data are given in Appendix 4, and is summarised below (Table 10 and Table 11).

TABLE 10

Increase in Dry Weight (mg per plant), and Rate of Increase (mg per plant per day x 1000) of 5 Selected Species between 1.5.69 and 11.7.69, (72 days) and between 1.5.69 and 5.8.69 (97 days).

n.r.=no record

<u>Area</u>	Increase in 72 days mg/plant	Rate of increase x 1000 mg/day	Increase between days 72 & 97 mg	Rate of increase x1000 bet. day 72 & 97	Increase in 97 days mg/plant	Rate of increase x1000 in 97 days
<u>HOLCUS LANATUS</u>						
in 2	123.2	1710	37.2	1488	160.4	1650
out 2	68.1	945	n.r.	n.r.	n.r.	n.r.
3	43.8	608	n.r.	n.r.	n.r.	n.r.
in 5	68.5	951	47.9	1916	116.4	1190
out 5	64.7	898	101.1	4040	165.8	1710
in 6	92.4	1283	152.8	6110	245.2	2520
out 6	77.9	1081	40.4	1616	118.3	1210
in 7	82.4	1144	29.7	1188	112.1	1150
out 7	58.6	813	48.3	1940	107.1	1100
in 8	n.r.	n.r.	n.r.	n.r.	85.9	885
out 8	24.0	333	55.2	2208	79.2	816
<u>FESTUCA RUBRA</u>						
in 2	18.2	252	8.3	332	26.5	273
out 2	24.0	333	n.r.	n.r.	n.r.	n.r.
3	21.5	298	n.r.	n.r.	n.r.	n.r.
in 5	17.4	241	6.3	252	23.7	244
out 5	14.5	201	26.2	1048	40.7	419
in 6	13.3	184	8.9	356	22.2	228
out 6	42.1	584	15.8	632	57.9	596
in 7	25.4	352	8.7	348	34.1	351
out 7	21.6	298	21.4	856	43.0	443

TABLE 10 contd.ANTHOXANTHUM ODORATUM

in 2	51.5	715	40.7	1628	92.2	950
out 2	54.5	756	n.r.	n.r.	n.r.	n.r.
in 5	63.6	883	35.2	1408	98.8	1018
out 5	39.8	552	52.8	2112	92.6	954
in 6	51.6	715	73.8	2952	125.4	129
out 6	47.9	665	60.6	2424	108.5	111
in 7	n.r.	n.r.	n.r.	n.r.	45.5	469
out 7	n.r.	n.r.	n.r.	n.r.	104.3	1070
in 8	50.1	696	8.0	320	58.1	598
out 8	70.1	973	29.0	1160	99.1	102

RHINANTHUS MINOR

out 2	214.3	3000	n.r.	n.r.	n.r.	n.r.
3	146.7	2000	n.r.	n.r.	n.r.	n.r.
in 5	105.9	1500	n.r.	n.r.	n.r.	n.r.
out 5	58.6	800	8.5	340	67.1	730
out 6	168.9	2300	41.7	1680	210.6	2160

TROLLIUS EUROPAEUS

Area	day number with maximum biomass mg per plant	increase in bio- mass mg per plant	rate of increase mg per plant per day
out 5	82	1571.6	19.2
out 6	91	1760.9	19.5

in 2 = inside enclosure at area 2

out 2 = outside enclosure at area 2.

TABLE 11

Comparing Productivity of Three Grass Species
in each of the Areas (A) Over 72 Days, and
(B) Over 97 Days.

<u>SPECIES</u>	AREA	Rate of increase mg/day x 1000	AREA	Rate of increase mg/day x 1000
<u>Holcus</u>	2	1328	6	1865
<u>lanatus</u>	6	1182	2	1650
	7	979	5	1450
	5	925	7	1125
	3	608	8	851
	8	333		
<u>Festuca</u>	6	384	6	412
<u>rubra</u>	7	325	7	397
	3	298	5	332
	2	293	2	273
	5	221		
<u>Anthoxanthum</u>	8	835	5	986
<u>odoratum</u>	2	736	2	950
	5	718	7	770
	6	690	8	350
			6	120

The above rates were calculated as a mean of the rates
inside and outside the exclosures at each area.

Thus by using what are very crude methods it is possible:-

- (i) to begin to understand the phenology of development of each farm unit, and
- (ii) to identify what could be optimum niches for each species within the farm system.

SUMMARY

Table 12 shows the floristic and "performance" characteristics of each vegetation type studied. The widespread presence and dominance of Holcus lanatus, Festuca rubra, Cerastium holostæodes, Poa trivialis, Rumex acetosa, Plantago lanceolata, Anthoxanthum odoratum and Prunella vulgaris (all underlined in Table 12), which are all character species of the class MOLINIO-ARRHENATHERETEA R.Tx 1937 (see Oberdorfer 1956 and Westoff et al. 1969), indicate that the vegetation complex belongs primarily to that class, and to the order MOLINIETALIA W.Koch 1926.

The communities of areas 2 and 3 on the better drained alluvial soils show an affinity to the associations of the order ARRHENATHERETALIA Pawlowski 1928. These communities are the most productive, at area 2 the maximum standing crop is 346g per m² and the net above ground production 7.2 g per m² per day, and at area 3 the maximum standing crop is 508 g per m² per day and the production 10.5 g per m² per day. The species showing their maximum production, as calculated by percentage dry weight increase and maximum dry weight attained, in these areas are marked in Table 12.

The Fell slopes (areas 7 and 8) support a mixture of communities. Associations of the alliance MOLINION W.Koch 1926 mixed with species of the two classes NARDO-CALLUNETEA Prsg. 1949 and OXYCOCO-SPHAGNETEA Br.Bl. and R.Tx 1943. Associations of these latter two classes are widespread higher on the Fell slope which has been less affected by man. At area 7-the inbyeland-maximum standing crop is 386 g per m² and production 5.7 g per m² per day, and at area 8-the outbyeland-maximum standing crop is 383 g per m² and production 5.1 g per m² per day.

TABLE 12 Showing (a) constancy of each species. All sets of quadrats at each area bulked (20 quadrats), and the percentage of times that a species was found was calculated, 5 = 80-100%, 4 = 60-80%, 3 = 40-60%, 2 = 20-40%, 1 = 5-20%, + = 1-5%. Roman numerals indicate species found at every sample time.

(b) the area in which certain species show maximum performance,

(i) as calculated by % dry weight increase (*),

(ii) as calculated by maximum dry weight attained (x).

and (c) the character species of the class MOLINIO-ARRHENATHERETEA R.Tx 1937 (these are underlined).

<u>SPECIES</u>	<u>AREA 2</u>	<u>AREA 3</u>	<u>AREA 4</u>	<u>AREA 5</u>	<u>AREA 7</u>	<u>AREA 8</u>
<i>Agrostis tenuis</i>	IV *	2		1	+	2
<i>Alopecurus pratensis</i>	III	IV *		+	1	+
<i>Bromus mollis</i>	IV *	IV		2		
<u><i>Holcus lanatus</i></u>	V	3 x *		V	V	2
<u><i>Festuca rubra</i></u>	IV	IV *x		V	V	II
<u><i>Cerastium holostéodes</i></u>	V x	IV		IV	2 *	+
<i>Ranunculus bulbosus</i>	IV	IV *x		V	3	
<u><i>Poa trivialis</i></u>	V x	IV			V *	
<u><i>Rumex acetosa</i></u>	V x	V *		III		
<i>Rhinanthus minor</i>	2 x	III		V *		
<i>Brachythecium rutabulum</i>	1	III		III	2	+
<i>Luzula campestris</i>			+	IV	1	2 *
<i>Carex caryophyllea</i>				IV		
<i>Anemone nemorosa</i>		1		IV		1
<u><i>Plantago lanceolata</i></u>	1	1	1	V	1	
<i>Centaurea nigra</i>		1		III		
<i>Acrocladium cuspidatum</i>			2	III	V	3
<u><i>Anthoxanthum odoratum</i></u>	1 x	1	+	V *	V	V
<i>Poa pratensis</i>	3	3		3	II	
<i>Festuca ovina</i>			1		IV *	3
<u><i>Prunella vulgaris</i></u>				1	II	
<i>Rhytidadelphus squarrosus</i>		+	2	2	IV	IV
<i>Agrostis canina</i>			2	1	III	V *
<i>Nardus stricta</i>			2		III *x	V

TABLE 12 contd.

<u>SPECIES</u>	<u>AREA 2</u>	<u>AREA 3</u>	<u>AREA 4</u>	<u>AREA 5</u>	<u>AREA 7</u>	<u>AREA 8</u>
<i>Carex panicea</i>			V *x		IV	V
<i>Carex pulicaris</i>			IV		IV	3 *x
<i>Eriophorum angustifolium</i>			V x		2 *	1
<i>Molinia caerulea</i>			V		3	2 *x
<i>Thuidium tamariscinum</i>				1	2	IV
<i>Hylocomium splendens</i>			2		1	III
<i>Lophocolea bidentata</i>			+	2	2	V
<i>Hieracium pilosella</i>	1					
<i>Conopodium majus</i>	3	3 *		1		
<i>Trifolium repens</i>	2 x	1		4	4	2 *
<i>Achillea millefolium</i>	2	3				
<i>Trisetum flavescens</i>	1	1				
<i>Geranium sylvaticum</i>	1					
<i>Dactylis glomerata</i>	1	1				
<i>Vicia cracca</i>	1	1				
<i>Eurhynchium swartzii</i>	+					
<i>Lathyrus pratensis</i>	1			1		
<i>Taraxacum paludosum</i>	1			1 *	2	
<i>Eurhynchium praelongum</i>	3	3		2	2	1
<i>Helictotrichon pubescens</i>		2 *		2		+
<i>Saxifraga granulata</i>		1	1	1		
<i>Alchemilla glabra</i>		1				
<i>Veronica chamaedrys</i>		1				
<i>Trifolium pratense</i>		+				
<i>Myosotis arvensis</i>		1		2		
<i>Carex pilulifera</i>			2			
<i>Campanula rotundifolia</i>			1	1	1	
<i>Potentilla erecta</i>			3 *	3	2	2
<i>Succisa pratensis</i>			1	1	+	
<i>Carex nigra</i>			1			
<i>Viola palustris</i>			1		+	3
<i>Juncus articulatus</i>			+		2	1
<i>Deschampsia caespitosa</i>			1		1	
<i>Sphagnum palustre</i>			2			2
<i>Carex echinata</i>			1			1

TABLE 12 contd.

<u>SPECIES</u>	<u>AREA 2</u>	<u>AREA 3</u>	<u>AREA 4</u>	<u>AREA 5</u>	<u>AREA 7</u>	<u>AREA 8</u>
<i>Juncus bulbosus</i>		+				
<i>Sphagnum recurvum</i>		2				
<i>Pseudoscleropodium purum</i>		+	1	2		2
<i>Calypogeia trichomanis</i>		+	1	2		1
<i>Leontodon hispidus</i>			2	+		
<i>Briza media</i>			1	2	*	
<i>Leontodon autumnalis</i>			2			
<i>Trollius europaeus</i>			2			
<i>Trifolium arvense</i>			+			
<i>Helictotrichon pratensis</i>			1			
<i>Ajuga reptans</i>			1			
<i>Lotus corniculatus</i>			1			
<i>Viola lutea</i>			2			
<i>Euphrasia</i> spp.			1			
<i>Bellis perennis</i>			1	+		
<i>Brachythecium rivulare</i>			1	+		
<i>Scapania undulata</i>			1	+		1
<i>Mnium punctatum</i>			2	2		2
<i>Galium saxatile</i>			1			2
<i>Hypnum cupressiforme</i>			1			2
<i>Montia fontana</i>				+		
<i>Cardamine flexuosa</i>				1		
<i>Sagina procumbens</i>				1		
<i>Carex flacca</i>				1		
<i>Juncus squarrosus</i>				2		
<i>Philonotis fontana</i>				1		
<i>Fissidens</i> sp.				+		
<i>Thuidium delicatulum</i>				+		
<i>Ranunculus flammula</i>				2		1
<i>Lysimachia nemorum</i>				+		+
<i>Carex demissa</i>				1		+
<i>Achillea ptarmica</i>				1		1
<i>Cynosurus cristatus</i>				2		+
<i>Aulocomnium palustre</i>				2		3

TABLE 12 contd.

<u>SPECIES</u>	<u>AREA 2</u>	<u>AREA 3</u>	<u>AREA 4</u>	<u>AREA 5</u>	<u>AREA 7</u>	<u>AREA 8</u>
Mnium undulatum					3	2
Dicranum scoparium					1	+
Pleurozium schreberi						+
Polytrichum commune						1
Climacium dendroides						1
Riccardia pinguis						1
Juncus conglomerata						1
Cirsium palustre						1

The wet "swamp" communities of area 4 have character species of both the order MOLINIETALIA W.Koch 1926 and of the class SCHEUCHZERIETEA Den Held, Barkman and Westoff cl. nov. Here are found some of the purest MOLINION W.Koch 1926 communities present in the study areas. The maximum standing crop is 317 g per m², and production is 5.7 g per m² per day.

The species-rich area 5 on the bank of glacial soil in the meadow belongs to the order MOLINITALIA W.Koch 1926 with affinities to the order ARRHENATHERETALIA Pawlowski 1928. Here, however, Luzula campestris, Carex caryophylla, Anemone nemorosa, Plantago lanceolata, Centaurea nigra, Acrocladium cuspidatum and Anthoxanthum odoratum are more abundant and other additional species (see Table 12) are present. Species characteristic of the alliance FILIPENDULION (Duvien 1946) Segal 1966 are found here. The maximum standing crop is 307 g per m² and production—the lowest of all the areas studied—is 5.0 g per m² per day.

All the above figures for maximum standing crop and production are calculated from results obtained from cropping experiments during the 1968 growing season. For a further account of the phytosociology of areas 4, 5 and along the river bank, based on a more detailed survey of the area, see page 94 and Appendix 10.

PART IIMINERAL REGIME OF THE COMMUNITIESAIM:- TO STUDY THE MINERAL REGIME OF THE COMMUNITIES

The complete results of the mineral analyses for each cropping date, expressed as

- (a) mineral content in mg per g dry weight per species,
 - (b) mean mineral content in mg per plant x 1000,
 - (c) mineral content in mg per m² per species, and
 - (d) mineral content of each species expressed as a percentage of the total mineral content of the community,
- are presented in Appendix 5, and (a) and (c) are plotted, with dry weight and increase in dry weight for comparison as graphs.

To compare the mineral balance of each ecosystem the total content of each mineral (mg per m²) at each sampling time of

- (a) the whole community,
- (b) the living plant material, and
- (c) the plant debris

were calculated and are presented in Appendix 6.

Table 6.1 is regarded as presenting the above ground standing crop of each mineral at each cropping time. The mineral content of each ecosystem increased during the study period, there was some fluctuation at areas 7 and 8. A high proportion of the minerals at all areas was present in the dead plant material, and in areas 7 and 8 between 20% and 25% of the minerals in the living plant material was present in the cryptogams.

A similar picture is obtained from Appendix 7, which presents the mineral content as a percentage of the maximum total of all four minerals found during the study period (area 3, 11.7.68 in the cases of the

whole community and living plant material, and area 3, 21.6.68 in the case of the dead plant material).

Appendix 8 shows the proportion of each mineral present in the whole community, the living plant material, and the plant debris, expressed as a ratio x 10.

Appendix 9 compares the above ground biomass and mineral contents of 5 hay meadow communities just prior to mowing.

When primary production of each community, as measured in PART I, was compared with either the maximum standing crop of any mineral or the uptake of any mineral (Table 13, calculated from Table 6.1 by subtracting the lowest mineral content of the whole community from the maximum mineral content) little correlation was seen. The best correlation being with potassium. (Table 14).

It is interesting to note that the two communities-areas 4 and 8-which have the lowest standing crops of potassium, are the ones which receive the least management. Of all the areas studied these come nearest to associations of the class SCHEUCHZERIETEA cl. nov. This class includes vegetation of poor fen and extreme poor fen where the nutrient supply is low and hence the ecosystem must rely on efficient mineral retention and recycling (Sjors 1950).

The above correlation of production with potassium uptake appears to indicate that management aids in making more potassium available to the community. Table 13 shows that the ecosystem at area 4 tends to remove less mineral nutrients from the mineral store-i.e. the minerals contained in the soil, also

TABLE 13

Maximum standing crop (mg per m²) of each mineral in the whole plant community.

Area	Sodium	Potassium	Calcium	Magnesium
2	938	5511	2264	1052
3	591	6818	5510	1879
4	203	1830	1925	857
5	907	3063	4195	1693
7	850	3359	2614	1205
8	309	1816	4642	4642

Uptake of each mineral (mg per m²) during the study period.

Area	Sodium	Potassium	Calcium	Magnesium	Total Uptake
2	740	3110	1530	627	6007
3	300	4756	2823	1391	9270
4	92	408	499	438	1437
5	701	665	2465	715	4546
7	571	1750	1467	556	4344
8	119	479	4052	537	5087

TABLE 14 Comparing Productivity, Maximum standing crop of potassium and Potassium uptake of each area

Area	Productivity mg per m ² per day	Maximum standing crop of K g per m ²	Potassium uptake mg per m ²
3	10.3	6818	4756
2	7.2	5511	3110
7	5.7	3359	1750
5	5.0	3063	665
4	5.7	1830	408
8	5.1	1816	479

the plant debris can be regarded as part of the mineral store--than do the more highly managed ones at areas 2 and 3. Table 15 shows tentative figures for the "efficiency"--the number of mg of each mineral required to produce 1 g dry weight of living plant material--for each community. These were estimated by dividing the figures calculated from Table 5.3 for the actual uptake of minerals into the living material by the production figures as obtained by method (B) (see page 38, litter being regarded as part of the mineral store).

Potassium is efficiently utilized by the "unmanaged" communities--areas 4 and 8. The ecosystem at area 4 is also very efficient in the utilization of sodium and calcium. Thus it would appear that increased production is obtained at the expense of "efficiency" in relation to an important nutrient, which may under natural conditions be in short supply or be unavailable. Benham's results (Appendix 1) show that potassium concentration in the soil is only slightly lower in the "unmanaged" areas, although the soil was sampled before any fertilizer had been applied to it.

The results show a lack of really distinct differences in mineral content at the level of the total community. A larger number of samples needed to be taken from each area. Any differences at the level of component species are unlikely to be statistically valid in the present study. Unfortunately there was not enough time available to collect and analyse a significantly sized number of samples. The following analysis is therefore simply presented in an attempt to explore the possibility of a more detailed study.

Table 16 shows "concentration"--mg per g dry weight--of each mineral in the total standing crop, the living plant material, and the dead plant material. Unfortun-

TABLE 15 Drain on Mineral Store

(A) Actual increment of each mineral into the live standing crop between 24.5.68 and 11.7.68 (mg per m²)

AREA	Sodium	Potassium	Magnesium	Calcium
2	805.0	5115.2	844.3	1547.4
3	731.9	6013.4	1802.3	5224.9
4	52.4	857.2	286.5	408.1
5	733.8	2161.3	990.5	2269.8
7	499.5	2027.4	679.7	1967.5
8	221.2	1173.3	529.4	2440.7

(B) Actual increment of each mineral into the live standing crop between 24.5.68 and 5.8.68 (mg per m²)

AREA	Sodium	Potassium	Magnesium	Calcium
5	822.3	2635.6	1687.3	2868.3
7	517.2	2492.6	952.4	2955.1
8	290.8	1547.7	718.2	3182.7

Production Figures as Calculated by Method (B)-total of maximum increase in dry weight of all species.

AREA	(a) in 48 days	(b) in 73 days (mg per m ²)
2	315	
3	460	
4	125	
5	206	284
7	136	156
8	130	150

Actual uptake of each mineral was calculated by subtracting the sum of the minimum mineral contents from the sum of the maximum mineral contents (mg per m²) of the species present-Appendix 5, Table 5.3.

TABLE 15 contd.

"Efficiency" of each system-mg used to produce
1 g dry weight of live standing crop.

(a) between 24.5.68 and 11.7.68, i.e. 48 days

AREA	Sodium	Potassium	Magnesium	Calcium
2	2.55	16.23	2.68	4.91
3	1.59	13.07	3.91	11.35
4	0.42	6.86	2.29	3.26
5	3.56	10.49	4.81	11.01
7	3.67	14.90	5.00	14.46
8	1.70	9.02	4.07	18.77

(b) between 24.5.68 and 5.8.68, i.e. 73 days

AREA	Sodium	Potassium	Magnesium	Calcium
5	2.90	9.28	5.94	10.09
7	3.32	15.97	6.11	18.94
8	1.94	10.31	4.79	21.21

TABLE 16 Individual and Total Mineral "Concentration"
(mg per g dry weight) of the Whole Community.

Area & Date	Mineral "concentration" mg per g dry weight			"Concentration" of total minerals mg/g	
	Sodium	Potassium	Magnesium	Calcium	
AREA 2					
24.5.68	1.3	15.1	2.7	4.6	25.7
7.6.68	2.5	16.8	2.9	5.4	27.6
21.6.68	2.0	16.3	3.1	6.6	28.1
11.7.68	2.7	14.5	2.8	4.4	24.4
AREA 3					
24.5.68	1.6	10.8	2.5	18.2	33.1
7.6.68	2.2	12.2	4.0	12.6	30.9
21.6.68	2.0	19.4	7.0	20.6	49.0
11.7.68	1.2	13.5	3.1	8.7	26.4
AREA 4					
24.5.68	0.8	8.0	2.2	10.0	21.0
7.6.68	0.8	8.5	3.0	11.4	23.7
11.7.68	0.6	5.8	2.7	4.5	13.6
AREA 5					
24.5.68	1.9	13.6	5.4	9.1	30.0
7.6.68	1.6	13.3	4.5	11.4	30.8
21.6.68	2.5	9.2	6.5	12.3	30.5
11.7.68	2.9	10.0	4.9	13.7	31.9
5.8.68	2.1	9.5	5.6	7.9	25.1
AREA 7					
24.5.68	2.2	5.5	3.1	6.7	17.5
7.6.68	1.5	6.5	3.1	4.7	15.8
21.6.68	0.9	10.9	3.5	6.4	21.7
11.7.68	1.1	7.8	2.6	4.8	16.3
5.8.68	1.0	10.2	3.6	12.4	27.2
AREA 8					
24.5.68	0.8	5.4	1.5	7.4	15.1
7.6.68	0.8	6.7	1.3	2.5	11.3
21.6.68	0.8	4.7	2.2	12.1	19.8
11.7.68	0.8	5.2	2.3	6.9	15.2
5.8.68	1.0	4.2	1.5	8.2	14.9

TABLE 16 contd. Individual and Total Mineral "Concentration"
(mg per g dry weight) of the Living Plant
Material.

Date & Area	Mineral "concentration" mg per g dry weight				"Concentration" of total minerals mg/g
	Sodium	Potassium	Magnesium	Calcium	
AREA 2					
24.5.68	1.8	24.1	3.1	5.2	34.1
7.6.68	3.3	22.5	3.2	5.1	34.1
21.6.68	2.1	17.3	3.1	6.0	28.5
11.7.68	2.9	16.3	2.7	3.9	25.8
AREA 3					
24.5.68	2.1	17.7	3.0	20.5	43.3
7.6.68	2.6	16.4	5.0	14.4	38.4
21.6.68	1.4	18.0	2.6	12.6	34.6
11.7.68	1.3	14.6	3.2	8.4	27.6
AREA 4					
24.5.68	1.2	17.1	3.0	11.0	32.2
7.6.68	0.9	16.0	3.0	10.0	29.9
11.7.68	0.7	9.1	2.9	3.8	16.3
AREA 5					
24.5.68	1.3	16.5	6.3	9.3	33.4
7.6.68	2.2	19.2	5.6	15.5	42.5
21.6.68	3.5	11.7	7.6	8.7	31.5
11.7.68	3.7	12.7	5.6	13.8	35.8
5.8.68	2.6	11.7	6.1	7.2	27.6
AREA 7					
24.5.68	3.0	8.3	3.8	9.1	24.2
7.6.68	2.1	9.9	3.6	5.4	21.0
21.6.68	1.0	13.8	3.6	7.9	26.3
11.7.68	1.3	9.8	2.8	4.3	18.3
5.8.68	1.2	12.3	4.2	13.6	31.3
AREA 8					
24.5.68	0.9	8.7	1.8	7.7	19.1
7.6.68	1.1	10.0	2.0	4.2	17.3
21.6.68	0.9	7.9	2.5	13.6	24.9
11.7.68	1.0	6.4	2.5	7.3	17.2
5.8.68	1.1	6.1	2.3	8.8	18.3

TABLE 16 contd. Individual and Total Mineral "Concentration"
(mg per g dry weight) of the Plant Debris.

Area & Date	Mineral "concentration" mg per g dry weight				"Concentration" of total minerals mg/g
	Sodium	Potassium	Magnesium	Calcium	
AREA 2					
24.5.68	0.7	5.0	2.2	3.9	11.8
7.6.68	1.0	6.8	2.3	5.8	15.9
21.6.68	1.6	8.8	2.8	11.3	24.5
11.7.68	1.7	6.2	3.1	6.8	17.8
AREA 3					
24.5.68	0.9	3.5	2.1	15.8	22.3
7.6.68	1.7	7.1	2.7	10.3	21.8
21.6.68	1.6	4.0	8.8	20.9	35.3
11.7.68	0.3	4.7	2.0	11.0	18.0
AREA 4					
24.5.68	0.6	1.9	1.6	9.2	13.4
7.6.68	0.7	1.5	2.7	12.8	17.7
11.7.68	0.6	1.4	2.4	5.5	9.9
AREA 5					
24.5.68	0.5	6.1	3.1	8.7	18.4
7.6.68	0.8	4.4	2.8	5.0	13.0
21.6.68	1.5	3.7	3.6	19.2	28.0
11.7.68	1.2	2.9	3.4	14.1	21.6
5.8.68	0.8	3.2	4.8	11.1	19.9
AREA 7					
24.5.68	1.5	2.8	2.4	4.5	11.2
7.6.68	0.7	2.1	2.4	3.6	8.8
21.6.68	0.7	5.0	3.4	3.2	12.3
11.7.68	0.6	2.8	2.0	6.0	11.4
5.8.68	0.6	4.5	1.8	9.3	16.2
AREA 8					
24.5.68	0.7	2.8	1.2	7.1	11.8
7.6.68	0.6	4.6	0.9	1.2	7.3
21.6.68	0.8	2.2	2.0	10.9	15.9
11.7.68	0.5	2.7	1.7	6.0	10.9
5.8.68	0.8	2.1	0.5	7.6	11.0

TABLE 16 contd.

"Concentration" of Sodium, Potassium, Calcium and Magnesium in (A) the Phanerogams and (B) the Cryptogams at areas 7 and 8 in mg per g dry weight.

Phanerogams

AREA	DATE	Sodium	Potassium	Magnesium	Calcium
7	24.5.68	23.2	10.9	3.7	6.2
	7.6.68	2.7	12.5	3.6	4.4
	21.6.68	1.2	18.8	3.8	6.8
	11.7.68	1.6	12.5	2.5	2.9
	5.8.68	1.4	14.7	3.9	9.7
8	24.5.68	0.8	11.9	1.4	7.8
	7.6.68	1.3	12.6	1.9	4.6
	21.6.68	1.0	12.7	2.3	7.6
	11.7.68	2.0	12.3	2.8	4.7
	5.8.68	1.6	9.6	2.8	6.4

Cryptogams

AREA	DATE	Sodium	Potassium	Magnesium	Calcium
7	24.5.68	2.7	5.3	4.0	12.2
	7.6.68	1.0	5.4	3.7	6.7
	21.6.68	0.8	6.7	3.2	9.5
	11.7.68	0.9	5.9	3.3	6.4
	5.8.68	0.7	7.2	4.7	21.5
8	24.5.68	1.0	4.4	2.4	7.6
	7.6.68	0.8	6.2	2.0	3.7
	21.6.68	0.7	3.7	2.6	18.8
	11.7.68	0.7	4.8	2.8	9.4
	5.8.68	0.7	3.7	1.9	10.4

ately the values for the "concentration" of these minerals within the plant material fluctuate a good deal so that it is difficult to pick out overall trends. This fluctuation must of course be in part due to the variability in the mineral content of the subcrops—the species themselves (Table 5.1). However, if a particular community or species was under the stress of limited supplies of a particular nutrient then it might be expected that either

(a) the "concentration" of that nutrient within the plant material would diminish, or
 (b) the "concentration" would remain the same, productivity being retarded. Only at areas 4 and 5 is there an overall reduction in the "concentration" of potassium. At areas 3 and 7 there is a sustained increase in "concentration" of potassium throughout development pointing to abundant available potassium, whereas at areas 2 and 8 there is simply slight fluctuation in the level of this mineral. Potassium "concentration" of the individual plant species (Table 5.1) shows much variation, the limited data gained from a broad study of this type not allowing conclusions to be drawn. However, possible fruitful lines of future research are indicated.

From Appendix 5 the average "concentration" of each mineral for a range of species over the study period was calculated and the results given in Table 17, and for the whole community in Table 17B. At each area the species which show their maximum performance (percentage increase in dry weight) are underlined, and those characterising the community type are marked with an asterisk. The maximum and minimum values for the "concentration" of each mineral are ringed. Again there are no strong correlations, but this kind of analysis, if carried out on a statistically sound number of samples, could indicate the species between which maximum competition for each nutrient might be expected.

TABLE 17 Average Mineral "Concentration" of Various Species During the Study Period. (mg per g dry weight) Plants showing their maximum performance (as calculated by percentage increase in dry weight) in each area are underlined. Character species are marked *. Maximum and minimum values are bracketed.

<u>Species & Area</u>	<u>Sodium</u>	<u>Potassium</u>	<u>Magnesium</u>	<u>Calcium</u>
<u>Area 2</u>				
<u>Holcus lanatus</u> *	2.8	23.6	2.3	4.1
<u>Poa trivialis</u> *	1.2	23.1	2.7	5.1
<u>Alopecurus pratensis</u> *	1.9	25.2	2.1	(2.9)
<u>Agrostis tenuis</u>	3.2	19.5	3.0	3.7
<u>Festuca rubra</u> *	(0.7)	21.9	(1.8)	3.2
<u>Bromus mollis</u>	2.5	(12.1)	2.4	3.0
<u>Ranunculus bulbosus</u>	4.5	12.3	3.9	6.5
<u>Rumex acetosa</u> *	(4.8)	(25.3)	(4.6)	7.5
<u>Trifolium repens</u> *	4.1	21.7	4.2	(10.3)
<u>Rhinanthus minor</u>	2.9	22.5	4.1	8.3
<u>Area 3</u>				
<u>Holcus lanatus</u> *	3.1	18.5	2.9	10.7
<u>Poa trivialis</u> *	1.0	21.2	3.4	15.2
<u>Alopecurus pratensis</u> *	1.6	15.7	3.7	17.3
<u>Festuca rubra</u> *	(0.6)	22.8	2.2	12.1
<u>Bromus mollis</u>	1.6	(7.9)	4.6	(7.5)
<u>Helictotrichon pubescens</u>	0.4	16.7	(2.0)	8.6
<u>Ranunculus bulbosus</u>	(5.1)	17.0	(5.8)	17.8
<u>Rhinanthus minor</u>	1.3	18.7	5.1	(21.3)
<u>Cerastium holosteodes</u> *	2.4	(24.4)	4.8	19.0
<u>Area 4</u>				
<u>Molinia caerulea</u>	(0.7)	14.6	(2.2)	8.4
<u>Eriophorum angustifolium</u>	(1.2)	(14.2)	2.9	(6.2)
<u>Carex panicea</u>	0.8	(17.4)	(3.9)	(10.4)

TABLE 17 contd.

<u>Species & Area</u>	<u>Sodium</u>	<u>Potassium</u>	<u>Magnesium</u>	<u>Calcium</u>
<u>Area 5</u>				
<u>Anthoxanthum odoratum</u> *	1.5	14.7	3.3	9.0
Holcus lanatus *	3.0	14.8	4.0	11.9
Poa trivialis *	1.3	(16.0)	4.2	8.3
Festuca rubra *	(0.7)	15.6	2.9	8.4
Cynosurus cristatus	2.8	14.4	(2.5)	(5.4)
Ranunculus bulbosus	3.5	15.1	4.4	15.9
Rumex acetosa *	2.1	12.8	7.5	14.7
Trifolium repens	2.9	10.6	6.1	(19.2)
Plantago lanceolata *	(5.3)	(8.6)	(9.5)	13.2
<u>Area 7</u>				
<u>Anthoxanthum odoratum</u> *	0.9	19.6	3.2	7.2
Holcus lanatus *	1.3	(23.3)	3.2	6.7
Festuca rubra *	(0.6)	16.3	3.1	5.1
<u>Nardus stricta</u>	0.7	10.7	2.1	4.9
Carex pulicaris	0.7	14.8	3.5	5.2
Carex panicea	0.9	18.6	3.7	8.9
<u>Juncus squarrosus</u>	2.6	(10.4)	(2.1)	(2.1)
Ranunculus bulbosus	(5.2)	17.9	7.1	(17.7)
Trifolium repens	2.5	14.9	(9.8)	14.6
<u>Area 8</u>				
Festuca rubra *	1.1	9.8	1.8	(7.8)
Nardus stricta	1.3	(9.3)	(1.4)	(1.9)
<u>Agrostis canina</u>	(1.5)	12.4	2.6	6.3
Carex panicea	(0.9)	(14.2)	(3.0)	6.3

TABLE 17B

Average Mineral "Concentration" (mg per g dry weight) of the Debris

AREA	Sodium	Potassium	Magnesium	Calcium
2	1.2	6.7	2.6	6.9
3	1.1	4.8	3.9	14.5
4	0.6	1.6	2.2	9.2
5	1.0	4.1	3.9	9.6
7	0.8	3.4	2.4	5.3
8	0.7	2.9	1.3	6.6

Average Mineral "Concentration" (mg per g dry weight) of the Whole Community

AREA	Sodium	Potassium	Magnesium	Calcium
2	2.1	15.7	2.9	5.2
3	1.7	14.0	4.2	15.0
4	0.7	7.4	2.7	8.6
5	2.2	11.1	5.4	10.9
7	1.3	10.2	3.2	6.7
8	0.9	5.2	2.2	7.4

Average Mineral "Concentration" (mg per g dry weight) of the Living Plant Material

AREA	Sodium	Potassium	Magnesium	Calcium
2	2.5	20.1	3.0	5.1
3	1.7	16.7	3.5	14.0
4	0.9	14.1	3.0	8.3
5	2.7	14.5	6.2	10.9
7	1.7	10.8	3.6	8.1
8	1.0	7.8	2.3	8.3

When the average "concentration" of the four minerals were totaled, and the results from species occurring in more than one area were compared, it was noted that these totals were similar (Table 18). On the supposition given above, it would appear that there is an excess, or greater ease of obtaining, certain of the minerals for Festuca rubra and Poa trivialis at area 3, and that certain nutrients are in short supply for Carex panicea and Nardus stricta in area 8 when compared with area 7. From Table 18B it seems that calcium is that mineral nutrient. Potassium and magnesium also seem more readily available at area 7 than area 8. Banham's results (Appendix 1) show that the meadow soils are richer in calcium than the other soils. Soil from area 7 was not tested but it has been limed in the past.

Calculation of the ratios of the average "concentration" of each mineral in each plant (Table 19) and comparison of the results of plants from different areas could also indicate if, and in which community, a particular mineral was less readily available for certain species. Table 20 comparing the mineral ratios of the four above mentioned species leads to the same conclusions as Table 18B. It also shows that there can be some similarity in the proportions of the four minerals for a species in different ecosystems, e.g. Ranunculus bulbosus. Table 20 also compares total average mineral "concentration", percentage dry weight increase, and maximum dry weight per plant for certain species. There is a marked correlation between all three values in the cases of Rumex acetosa, Carex panicea and Nardus stricta, and some correlation between these values for Ranunculus bulbosus, Festuca rubra, Poa trivialis and Holcus lanatus.

The "efficiency" with which the various plant species can utilize the different minerals at each area would also be data useful in the understanding of the

TABLE 18

Total "Concentration" of the Four Minerals (mg per g dry weight). in Certain Species.

<u>SPECIES</u>	<u>AREA 2</u>	<u>AREA 3</u>	<u>AREA 4</u>	<u>AREA 5</u>	<u>AREA 7</u>	<u>AREA 8</u>
Holcus lanatus	32.8	35.2		33.7	34.5	
Poa trivialis	32.1	40.8		29.8		
Festuca rubra	27.6	37.7		27.6	25.1	
Carex panicea			32.5		32.1	24.4
Nardus stricta					17.7	13.9
Ranunculus bulbosus	27.2	45.6		38.9	47.9	
Alopecurus pratensis	32.1	38.3				
Bromus mollis	20.0	21.6				
Rumex acetosa	42.2	46.4		37.1		
Trifolium repens	40.3			38.8	41.8	
Rhinanthus minor	37.8	46.4				
Anthoxanthum odoratum				28.5	30.9	

TABLE 18B

Average "concentration" (mg per g dry weight) of each mineral in Poa trivialis, Festuca rubra, Carex panicea, and Nardus stricta during the study period.

Poa trivialis

Area	Sodium	Potassium	Magnesium	Calcium
2	1.2	23.1	2.7	5.1
3	1.0	21.2	3.4	15.2
5	1.3	16.0	4.2	8.3

Festuca rubra

Area	Sodium	Potassium	Magnesium	Calcium
2	0.7	21.9	1.8	3.2
3	0.6	22.8	2.2	12.1
5	0.7	15.6	2.9	8.4
7	0.6	16.3	3.1	5.1

Carex panicea

Area	Sodium	Potassium	Magnesium	Calcium
4	0.8	17.4	3.9	10.4
7	0.9	18.6	3.7	8.9
8	0.9	14.2	3.0	6.3

Nardus stricta

Area	Sodium	Potassium	Magnesium	Calcium
7	0.7	10.7	2.1	4.9
8	1.3	9.3	1.4	1.9

TABLE 19:

RATIOS OF THE AVERAGE MINERAL CONCENTRATION X 10

	Na	K	Mg	Ca
<u>AREA 2</u>				
Holcus lanatus	12	103	<u>10</u>	18
Poa trivialis	<u>10</u>	193	23	43
Alopecurus pratensis	<u>10</u>	133	11	24
Agrostis tenuis	11	65	<u>10</u>	12
Festuca rubra	<u>10</u>	312	26	46
Bromus mollis	<u>10</u>	50	<u>10</u>	13
Ranunculus bulbosus	11	32	<u>10</u>	17
Rumex acetosa	10	55	<u>10</u>	16
Trifolium repens	<u>10</u>	53	10	25
Rhinanthus minor	<u>10</u>	78	14	29
<u>AREA 3</u>				
Holcus lanatus	11	64	<u>10</u>	37
Poa trivialis	<u>10</u>	212	<u>34</u>	152
Alopecurus pratensis	<u>10</u>	98	23	108
Festuca rubra	<u>10</u>	380	37	201
Bromus mollis	<u>10</u>	49	29	47
Helictotrichon pubescens	<u>10</u>	418	50	21
Ranunculus bulbosus	<u>10</u>	33	11	35
Rhinanthus minor	<u>10</u>	144	49	164
Cerastium holostoides	<u>10</u>	102	20	79
<u>AREA 4</u>				
Molinia caerulea	<u>10</u>	209	31	120
Eriophorum angustifolium	<u>10</u>	118	24	52
Carex panicea	<u>10</u>	218	49	130
<u>AREA 5</u>				
Anthoxanthum odoratum	<u>10</u>	98	22	60
Holcus lanatus	<u>10</u>	49	13	40
Poa trivialis	<u>10</u>	123	32	64
Festuca rubra	<u>10</u>	223	41	120
Cynosaurus cristatus	11	58	<u>10</u>	22
Ranunculus bulbosus	<u>10</u>	43	<u>13</u>	45
Rumex acetosa	<u>10</u>	61	36	70
Trifolium repens	<u>10</u>	36	21	66
Plantago lanceolata	<u>10</u>	16	18	25

TABLE 192 contd.

	<u>Na</u>	<u>K</u>	<u>Mg</u>	<u>Ca</u>
<u>AREA 7</u>				
Anthoxanthum odoratum	<u>10</u>	218	36	80
Holcus lanatus	<u>10</u>	179	25	51
Festuca rubra	<u>10</u>	272	52	85
Nardus stricta	<u>10</u>	153	30	70
Carex pulicaris	<u>10</u>	212	50	74
Carex panicea	<u>10</u>	207	41	99
Juncus squarrosus	<u>12</u>	50	<u>10</u>	<u>10</u>
Ranunculus bulbosus	<u>10</u>	34	<u>14</u>	<u>34</u>
Trifolium repens	<u>10</u>	60	39	58
<u>AREA 8</u>				
Festuca ovina	<u>10</u>	89	16	71
Nardus stricta	<u>10</u>	72	10	15
Agrostis canina	<u>10</u>	83	17	42
Carex panicea	<u>10</u>	158	33	70

TABLE 19 contd.RATIOS OF TOTAL AVERAGE MINERAL CONCENTRATION IN DEBRIS

	<u>Na</u>	<u>K</u>	<u>Mg</u>	<u>Ca</u>
Area 2	<u>10</u>	56	22	57
Area 3	<u>10</u>	44	35	132
Area 4	<u>10</u>	27	37	153
Area 5	<u>10</u>	41	39	96
Area 7	<u>10</u>	43	30	66
Area 8	<u>10</u>	41	20	94

RATIOS OF TOTAL AVERAGE MINERAL CONCENTRATION IN WHOLE COMMUNITY

Area 2	<u>10</u>	75	14	25
Area 3	<u>10</u>	79	24	87
Area 4	<u>10</u>	106	39	123
Area 5	<u>10</u>	50	25	50
Area 7	<u>10</u>	78	25	52
Area 8	<u>10</u>	58	20	82

RATIOS OF TOTAL AVERAGE MINERAL CONCENTRATION IN LIVING PART OF COMMUNITY

Area 2	<u>10</u>	80	12	20
Area 3	<u>10</u>	89	18	78
Area 4	<u>10</u>	157	33	92
Area 5	<u>10</u>	54	23	40
Area 7	<u>10</u>	63	21	48
Area 8	<u>10</u>	78	23	83

TABLE 20

(i) Compares the ratios of mineral "concentration" between areas for certain species.

(ii) Shows the correlation between maximum dry weight, total average mineral "concentration" and percentage increase in dry weight.

(iii)

Species	Area	Mineral ratio x 10				Maximum dry weight per plant mg	Total ave- rage min. "conc".	% increase in dry weight.
		Na	K	Mg	Ca			
Ranunculus bulbosus	2	11	32	10	17	190.7	27.2	121
	3	10	33	11	35	266.2	45.6	443
	5	10	43	13	45	58.6	38.9	321
	7	10	34	14	34	98.9	47.9	259
Festuca rubra	2	10	312	26	46	7.4	27.6	40
	3	10	380	37	201	12.6	37.7	180
	5	10	223	41	120	8.4	27.6	100
	7	10	172	52	85	8.3	25.1	100
Poa trivialis	2	10	193	23	43	18.6	32.1	89
	3	10	212	34	152	12.5	40.8	140
	5	10	123	32	64	7.9	29.8	300
Holcus lanatus	2	12	103	10	18	63.6	32.8	909
	3	11	64	10	37	363.8	35.2	3933
	5	10	49	13	40	18.1	33.7	350
	7	10	179	25	55	22.1	34.5	267
Rumex acetosa	2	10	55	10	16	293.2	42.2	946
	5	10	61	36	70	55.9	37.1	460
Carex panicea	4	10	818	49	130	115.7	32.5	190
	7	10	207	41	99	63.3	32.1	133
	8	10	158	33	70	58.2	24.4	123
Nardus stricta	7	10	153	30	70	18.0	17.7	100
	8	10	72	10	15	15.9	13.9	45

community. Also the uptake ability of the component species is one of the important factors determining the amount of minerals in the standing crop. Table 21 presents the "efficiency" of Carex panicea, Festuca rubra and Ranunculus bulbosus.

Carex panicea shows its maximum development, or production "efficiency" (percentage increase in dry weight) at area 4. This is correlated with maximum "efficiency" in relation to the utilization of sodium, calcium and to a lesser extent potassium, and to an overall total "efficiency".

Festuca rubra shows its maximum production "efficiency" at area 3. This is correlated with an "efficient" use of calcium. It has already been shown that at this area this plant has a higher calcium "concentration" than elsewhere.

Ranunculus bulbosus shows its maximum production "efficiency" at area 3. This is correlated with "inefficient" mineral utilization.

As already pointed out much more intensive work is necessary before such results could be accepted as anything more than indications. It is suggested that the work could be developed by detailed study of simple communities which would permit the collection and analysis of a statistically sound number of replicates. It must however be realised that any measurements of this kind must be viewed in relation to the overall mineral "budget" of each farm unit studied. This is attempted below with the results obtained from this study.

TABLE 21

Dry Weight Increment, Percentage Increase in Dry Weight, Nutrient Uptake and "Efficiency" of Carex panicea, Festuca rubra and Ranunculus bulbosus.

CAREX PANICEA

		Area		
		4	7	8
Dry Weight increment		26.5	8.5	7.9
g per m ²				
% increase in dry weight		190	133	123
Nutrient ₂ uptake	Na	2.4	4.5	9.3
mg per m ²	K	238.0	125.0	48.0
	Mg	94.6	10.7	15.1
	Ca	39.5	109.6	48.6
"Efficiency"	Na	0.09	0.53	1.18
mg per g dry weight	K	8.98	14.7	6.07
	Mg	3.57	1.25	1.91
	Ca	1.49	12.8	6.15
TOTAL "EFFICIENCY"		14.13	29.28	15.31

FESTUCA RUBRA

		Area			
		2	3	5	7
Dry Weight increment		3.6	51.1	12.9	4.7
g per m ²					
% increase in dry weight		40	180	100	100
Nutrient ₂ uptake	Na	3.2	19.4	11.5	0.9
mg per m ²	K	99.0	1100.7	143.8	67.2
	Mg	5.9	100.0	36.0	10.0
	Ca	19.4	184.4	270.7	19.1
"Efficiency"	Na	0.89	0.38	0.89	0.19
mg per g dry weight	K	27.50	21.50	11.14	14.29
	Mg	1.64	1.95	2.79	2.12
	Ca	5.38	3.6	20.98	4.06
TOTAL "EFFICIENCY"		35.41	27.43	35.80	20.66

TABLE 21 contd.RANUNCULUS BULBOSUS

		Area			
		2	3	5	7
Dry Weight increment		8.9	14.3	14.8	5.4
g per m ²					
% increase in dry		121	443	321	259
weight					
Nutrient ₂ uptake	Na	109.7	124.2	72.2	28.9
mg per m ²	K	135.9	277.6	154.0	70.3
	Mg	72.2	199.9	129.7	6.2
	Ca	153.6	349.4	336.3	45.5
"Efficiency"	Na	12.3	8.68	4.88	3.35
mg per g dry	K	15.2	19.41	10.4	13.01
weight	Mg	8.11	13.97	8.76	1.15
	Ca	17.2	24.43	22.72	8.42
TOTAL "EFFICIENCY"		52.81	67.49	46.76	27.93

MINERAL "BUDGET" OF EACH COMMUNITY

Once the "drain"-~~actual~~ uptake of each mineral by the living plants-on the "mineral store" has been calculated it is possible to draw up a "mineral balance sheet" (Table 23). As the values used for minerals leached by rain (Park et al. 1962), contained in the soil (Benham 1969), supplied in sheep dung (Park et al. 1962), by rain (Gore 1956), and by manure (Hemingway 1961, Boyd et al. 1961) are not the results of analyses carried out during 1968 in Upper Teesdale, this table can only give some idea as to the mineral balance of each ecosystem.

Areas 2 and 3 are sometimes flooded in the spring when the snow melts, the extent and duration of flooding is very variable, in March 1968 the river rose up to the level of Cronkley Bridge. It is very difficult to estimate the amount of minerals deposited in the silt. Figures presented by Crisp (1966) for the analysis of water and suspended peat from Rough Sike (NY 758329) are given in Table 22. These could be

TABLE 22

Stream water output, the amount of suspended peat and the quantities of five elements contained in this water and peat estimated for 1963.

	Quantity	Elements					(Kg per year)
		Na	K	Ca	P	N	
Stream	1368 m ³						
water	x 10	3755	744	6461	33	244	
Suspended	9306 Kg						
peat	dry weight	23	171	401	37	1214	

some indication as to the proportions of the various minerals in the waters of the River Tees, and do show that flood water would be a rich source of minerals.

TABLE 23

MINERAL BALANCE SHEET

Area	NPK Fert.	INPUT			STORE		OUTPUT		
		Rain	Sheep Dung	F.Y.M.	Debris	Soil	Leach- ing	"Drain"	
SODIUM	2		2.19			0.1	15.10	0.8	
	3		2.19			0.2		0.7	
	4		2.19			0.1	12.63	0.05	
	5		2.19			0.1	16.44	0.7	
	7		2.19			0.3		0.5	
	8		2.19			0.2	14.15	0.2	
POTASSIUM	2	2.67	0.16	0.29	1.29	0.4	10.13	0.20	5.1
	3	2.67	0.16	0.29	1.29	0.7		0.20	6.0
	4		0.16			0.2	9.35	0.20	0.9
	5		0.16	0.29		0.4	10.95	0.20	2.2
	7		0.16	0.29		0.6		0.20	2.0
	8		0.16	0.29		0.6	8.72	0.20	1.2
MAGNESIUM	2		0.31		0.34	0.2	42.40		0.8
	3		0.31		0.34	0.9			1.8
	4		0.31			0.3	23.74		0.3
	5		0.31			0.5	66.38		1.0
	7		0.31			0.5			0.7
	8		0.31			0.4	25.03		0.5
CALCIUM	2		0.65		0.74	0.5	309.41	3.34	1.5
	3		0.65		0.74	2.2		3.34	5.2
	4		0.65			1.1	138.12	3.34	0.4
	5		0.65			1.6	384.91	3.34	2.3
	7		0.65			1.0		3.34	2.0
	8		0.65			2.3	90.80	3.34	2.4

Most of the figures presented in this balance sheet had to be corrected to g per m² per year. The soil mineral content was estimated by totaling the minerals present in the top 32cm (Benham 1969, plant roots were not found at a greater depth).

For the quantity of minerals stored in the plant debris the maximum value found at each area during the experimental period was used.

Park et al. (1962) in their paper give the average amount of minerals contained in sheep dung deposited on a known area of Festuca-Agrostis sward near Moor House in 1957. By assuming that grazing pressures were comparable these figures could show the quantity of minerals available from this source. In the meadow sheep would graze areas 2 and 3 preferentially, and area 4 only lightly. For 2-3 months in the summer the sheep are absent from the meadows, and during the harder winter months they are absent from areas 7 and 8. Also given in this paper were the values for the amounts of minerals leached from the soil during 1959 and 1960:-

	<u>1959</u>	<u>1960</u>	
Ca	2.24	4.44	Corrected
K	0.21	0.18	to g per
P	0.02	0.02	m ² per
Total N	0.01	0.02	year.

An average of these two years' results was used. This can only be used as very rough approximation due to the soil differences between the two areas.

Gore's (1956) figures for the mineral analysis of rain water were used in preference to Crisp's (1966), as they were the result of several years' work.

The mineral content of farmyard manure (Hemingway 1961)

was calculated by analysing partly rotted manure from byres in West Scotland. The quantity of manure applied to Upland farms varies between 1.4-2.5 tons per acre (Boyd et al 1961) and in this table it is assumed that about 2 tons per acre was the quantity used.

The above account illustrates the basic problems of all studies of production ecology, showing the crudity of the estimates, and emphasising the need for much more basic research before conclusions can be drawn.

CONCLUSIONS

The aim of the study was to obtain data relating to the floristic composition, productivity and mineral regime of the main component ecosystems of a typical farm in Upper Teesdale. The floristic data has been summarised in Table 12, on page 57 and in more detail on page 94. The production and mineral regimes are summarised in Table 24.

The main conclusions are that production and mineral regime are related to the amount of "management"-grazing, fertilization, mowing and drainage. "Management" results in increase in productivity, not only in terms of increased production of biomass, but also of the type of biomass. The more palatable grasses, typical of the *ARRHENATHERETALIA* Pawloski 1928, replacing the abundant cryptograms of the *MOLINIETALIA* W.Koch 1926. As only above ground biomass was sampled the production as calculated in this study may only be $\frac{1}{3}$ of the total-above and below ground-production of plant material (Malmer 1969).

Increased production is accomplished at the expense of production "efficiency", especially in relation to potassium utilization. The more rapid turn-over of organic and inorganic nutrients accompanying increased production must cause a breakdown of the natural retention and recycling of nutrients by the more natural ecosystems. Available nutrients can limit plant growth, Malmer (1969) noted that potassium, nitrogen and phosphorous were the main limiting mineral macro-elements for meadow production in South Sweden. Hence in order to maintain productivity man must provide sufficient nutrients to compensate for those removed, and to satisfy the demand.

Although the results presented here are not statistically

TABLE 24 Summary of the Production and Mineral Regime of the Six Study Areas.

Area		2	3	4	5	7	8
Maximum standing of plant material							
g dry weight per m ²		346	508	317	307	386	383
Productivity							
g per m ² per day		7.2	10.5	5.7	5.0	5.7	5.1
Maximum standing crop of each mineral							
mg per m ²	K	5511	6818	1830	3063	3359	1816
	Na	938	591	203	907	850	309
	Mg	1052	1879	857	1693	1205	851
	Ca	2264	5510	1925	4195	2614	4642
Overall uptake of each mineral							
mg per m ²	K	5115	6013	857	2161	2027	1173
	Na	805	732	52	734	500	221
	Mg	844	1802	287	991	680	529
	Ca	1547	5225	408	2270	1968	2441
"Efficiency" of utilization of each mineral							
mg per g dry weight	K	16.23	13.07	6.86	10.49	14.90	9.02
	Na	2.55	1.59	0.42	3.56	3.67	1.70
	Mg	2.68	3.91	2.29	4.81	5.00	4.07
	Ca	4.91	11.35	3.26	11.01	14.46	18.77

sound they do indicate that this is a useful line for a more detailed future investigation. The results obtained could eventually be used to improve the hay crop and grazing swards by suggesting new seed mixtures and improving the added fertilizers.

PHYTOSOCIOLOGICAL SURVEY OF UNMOWN AREAS OF MEADOW

To further investigate the vegetation of the valley bottom, and especially that of the alluvial meadows, the floristic composition of 137, 2m x2m quadrats was analysed. All quadrats were placed in areas of the alluvial meadow which are not mown for hay, either because they are too near ditches and streams, or the slope is too great, or the soil too wet (see map, Fig.10.1). It is thought that the vegetation of the whole alluvial area may have been the same, or similar, to that of these areas before "management".

Association analysis (Williams and Lambert, 1959) of the data was done using a computer. χ^2 (with Yates' correction) was used as a test of significance. Species with the highest $\sum \chi^2$ (without Yates' correction, and all χ^2 values were considered whether they were significant or not) were used to divide the quadrat groups. When the highest χ^2 value (with Yates' correction) was less than 3.841 (regarded as non-significant) or the number of quadrats was less than 8 the group was not subdivided, and was considered as a "final group". This resulted in 35 "final groups", but as some of these were very similar, or consisted of a small number of quadrats, they were clumped together to form 17 groups. (Fig 10.2). Only presence and absence data were used in this method and it is possible that spurious groupings may have been formed. The percentage frequency of occurrence of each species in each of the 17 quadrat groups was also calculated by the computer (Table 10.1).

The table (Table 10.1) shows that the vegetation belongs primarily to the class MOLINIO-ARRHENATHERETEA R.Tx.1937, order MOLINIETALIA W.Koch 1926, and alliance MOLINION CAERULEAE W.Koch 1926. As the survey was very detailed over a small area it is very difficult to name the

vegetation types present. However, it does appear that there are three communities present.

The quadrat groups A-H (not C) show affinity to the order ARRHENATHERETALIA Pawloski 1928, and are characterised by the absence of Molinia caerulea. The quadrats belonging to these groups were all situated in the drier unmown meadow areas, e.g. the river bank.

The remaining quadrat groups, situated in damp to wet areas, are characterised by the presence of Molinia caerulea and are more typical of the order MOLINIETALIA W.Koch 1926. They can be divided into two varieties:-

(a) groups C,I,J and K possessing most of the differential species, e.g. Centaurea nigra and Alchemilla glabra, and

(b) groups L-Q lacking most of the differential species but Festuca ovina and Viola palustris are very constant.

Much more phytosociological work must be undertaken on the grasslands of Teesdale in Britain before further conclusions are possible. However, it does seem safe to conclude that the communities on the lower Fell slopes and the valley bottoms, which developed when the forests were destroyed (Pigott 1956), can be classified within the great pan-European class of grasslands. Anemone nemorosa, Conopodium majus, Mnium hornum, Thuidium tamariscinum and Holcus mollis are probably the last remnants of the woodland flora.

REFERENCES

- BELLAMY, D.J., BRIDGEWATER, P., MARSHALL, C & TICKLE, W.M.,
1969. Status of the Teesdale Rarities.
Nature Vol.222, No. 5190.
- BLACKHOUSE, J.&J. 1843. An account of a visit to
Teesdale in the summer of 1843.
Phytologist 1:892-5.
- BOYD, D.A., CHURCH, B.M. & HILLS, M.G. 1961. Fertilizer
practice in England and Wales. I. General
features of fertilizer consumption 1956-7.
Emp.J.Expt.Agric. 29:35-44.
- CRISP, D.T. 1966. Input and Output of minerals for
an area of Pennine moorland: the
importance of precipitation, drainage,
peat erosion and animals.
J.App.Ecol. 3:327-347.
- GORE, A.J.P. 1968. The supply of 6 elements by
rain to an upland peat area.
J.Ecol. 56:483-95.
- HEMINGWAY, R.G. 1961. The mineral composition of
Farmyard manure.
Emp.J.Expt.Agric. 29:14-19.
- JEFFERIES, R.L. & WILLIS, A.J. 1964. Studies on the
Calcicole-Calcifuge habit. I. Methods
of Analysis of soil and plant tissues
and some results of investigations on
4 species.
J.Ecol. 52:121-138.
- JEFFRIES, T.A. 1915. Ecology of the Purple Heath
Grass (Molinia caerulea).
J.Ecol. 3:93-109.

- LOACH, K. 1968. Seasonal Growth and Nutrient uptake
in a Molinietum.
J.Ecol. 56:433-444.
- MALMER, N. 1969. Organic matter and cycling of minerals
in virgin and present ecosystems.
Oikos Suppl. 12:79-86.
- PARK, K.J.F., RAWES, M. & ALLEN, S.E. 1962. Grassland
studies on the Moor House National Nature
Reserve.
J.Ecol. 50:53-62.
- PEARSALL, W.H. 1950. Mountains and Moorlands.
London.
- PEARSALL, W.H. & MASON, F.A. 1925. Middleton-in-Teesdale
and its natural history.
Naturalist. pp.249-52.
- PIGOTT, C.D. 1956. The vegetation of Upper Teesdale.
J.Ecol. 44:545-85.
- RIELEY, J.O. 1967. The Ecology of *Carex flacca* Schreb.
and *Carex panicea* L.
Ph.D. Thesis (Durham)
- SJORS, H. 1950. Regional studies in North Swedish
mire vegetation.
Bot.Not.Lund pp.173-222.
- TANSLEY, A.G. 1911. Types of British Vegetation.
p.268.
- WILLIAMS, W.T. & LAMBERT, J.M. 1959. Multivariate
methods in plant ecology. I. Association
analysis in plant communities.
J.Ecol. 47:83-101.
- BLACKHOUSE, J. 1844. Notes on a botanical ramble
in Yorkshire etc., in the summer 1844.
Phytologist 1:1065-9.
- BENHAM, B. 1969. Studies on marginal farm
ecosystems in Upper Teesdale
M.Sc Thesis (Durham)

SITE 5A

Depth Class	Carbonate gms./m. ²	Potassium gms./m. ²	Sodium gms./m. ²	Calcium gms./m. ²	Magnesium gms./m. ²	Phosphorous gms./m. ²	Nitrate Nitrogen gms./m. ²
a	324.77	4.19	3.97	82.27	15.6 ^{1b}	0.65	0.51
b	326.45	2.49	4.66	83.94	16.71	0.66	0.93
c	394.44 ⁹	2.46	4.11	119.96	19.72	0.38	0.33
d	394.49	1.81	3.70	88.74	14.79	0.44	0.25
e	474.67	1.66	3.54	105.76	19.57	0.35	0.25
f	512.97	1.97	3.85	137.65	24.79	0.26	0.17
g	468.34	1.97	3.90	130.64	22.18	0.23	0.16
h	311.78	2.40	3.60	106.33	19.59	0.40	0.32
i	65.95	0.32	0.60	13.00	2.50	0.22	0.12

SITE 2A

a	429.95	2.71	3.03	95.72	7.68	11.32	1.54
b	375.89	2.80	3.46	91.40	8.11	0.99	0.74
c	354.71	2.44	4.53	70.94	12.61	0.37	0.55
d	280.08	2.18	4.08	51.35	14.00	0.32 ²⁷	0.47
e	46.68	0.52	1.35	9.80	2.10	0.17	0.10

Depth Class	Carbongte gms./m ² .	Potassium gms./m ² .	Sodium ₂ gms./m	Calcium gms./m ² .	Magnesium gms./m ² .	Phosphorous gms./m ² .	Nitrate ₂ Nitrogen gms./m ² .
a	162.11	3.80	3.46	627.24	9.29	0.07	0.17
b	167.62	2.51	3.20	32.25	7.17	0.06	0.20
c	221.85	1.59	2.84	36.40	3.98	0.03	0.17
d	237.55	1.45	3.13	42.23	3.30	0.02	0.20
e	231.56	1.48	3.02	51.01	3.36	0.08	0.20
f	279.53	1.58	3.76	47.30	5.02	0.88	0.14
<u>SITE 8</u>							
a	213.63	4.07	3.63	18.02	6.68	0.12	0.20
b	274.21	2.36	4.66	20.18	7.24	0.10	0.23
c	277.82	0.97	2.42	20.63	5.05	0.02	0.21
d	264.59	1.32	3.44	31.97	6.06	0.01	0.22
e	367.12	2.22	4.26	64.52	11.12	0.12	0.23
f	389.37	2.45	4.45	65.26	11.87	0.57	0.24
g	433.86	2.67	4.82	78.62	14.09	0.62	0.22
h	456.11	2.67	4.45	92.71	17.80	0.85	0.22

The soil profile was divided into "depth classes"-
each 8 cm deep.

APPENDIX 12, TABLE 112

Sample depth	Fresh wt. (gms.)	Dry wt. (gms.)	Water content (% fresh) (wt.)	Ash wt. (gms.)	Organic matter (% dry) (wt.)
<u>SITE 5</u>					
0- 8cms.	28.0	18.2	35	16.5	9.3
8-16cms.	29.0	21.3	30	19.9	6.6
16-24cms.	28.5	21.2	26	20.1	6.1
24-32cms.	34.5	25.5	26	24.0	5.9
32-40cms.	20.9	15.6	25	14.8	5.1
40-48cms.	30.7	23.6	23	22.6	4.2
48-56cms.	28.4	21.0	26	19.9	5.2
56-64cms.	30.0	21.6	28	20.4	5.5

SITE 2

0- 8cms.	16.4	8.2	50	7.0	17.0
8-16cms.	16.4	11.8	28	11.1	6.3
16-24cms.	17.0	13.1	23	12.5	5.0
24-32cms.	18.6	14.2	24	13.6	4.0

APPENDIX 1 Table 1.2 contd.SITE 3

Sample depth	Fresh wt. (gms.)	Dry wt. (gms.)	Water content (% fresh) (wt.)	Ash wt. (gms.)	Organic matter (% dry) (wt.)
0- 8cms.	36.1	18.0	50	15.5	14.0
8-16cms.	19.0	13.4	35	12.5	6.7
16-24cms.	21.9	15.8	32	14.8	6.3
24-32cms.	14.4	10.2	29	9.6	5.9
32-40cms.	23.0	16.7	27	15.7	6.0

SITE 4

0- 8cms.	20.6	7.8	62	6.0	23.1
8-16cms.	17.0	7.7	55	6.3	18.2
16-24cms.	24.2	12.2	50	10.6	13.9
24-32cms.	23.3	13.4	42	12.4	7.5
32-40cms.	21.1	12.5	41	11.4	8.8
40-48cms.	28.5	17.9	37	16.8	6.1



APPENDIX 1 Table 1.2 contd.SITE 7

Sample depth	Fresh wt. (gms.)	Dry wt. (gms.)	Water content (%fresh) (wt.)	Ash wt. (gms.)	Organic matter (% dry) (wt.)
0- 8cms.	18.2	6.0	67	4.1	31
8-16cms.	19.5	9.3	52	7.8	16
16-24cms.	18.9	9.0	52	7.7	14
24-32cms.	19.0	10.1	47	8.9	12
32-40cms.	23.0	15.5	33	14.4	7
40-48cms.	24.9	18.5	26	17.7	4
48-56cms.	32.0	23.5	27	22.5	4

SITE 8F

0- 8cms.	13.5	3.9	71	2.5	36
8-16cms.	16.3	6.2	62	5.0	19
16-24cms.	15.4	6.4	58	5.2	19
24-32cms.	15.9	8.8	45	8.0	9
32-40cms.	15.2	11.2	26	10.9	3
40-48cms.	14.2	10.5	26	10.2	3

FIGURE 1.1 Total alkalinity of areas 5, 2, 4 and 8
(Expressed as Carbonate)

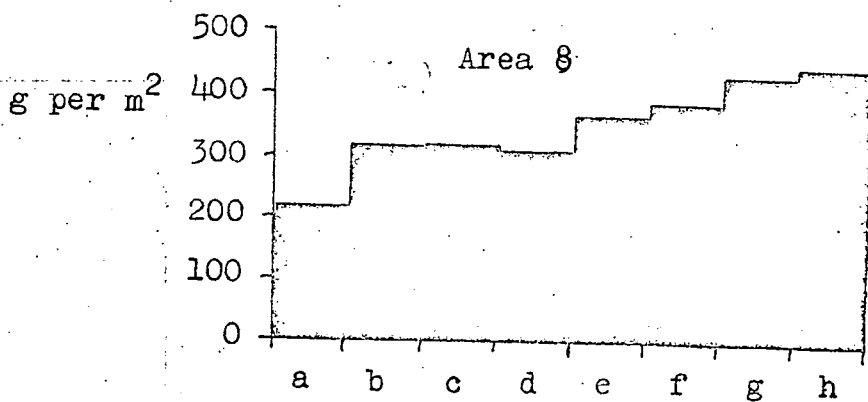
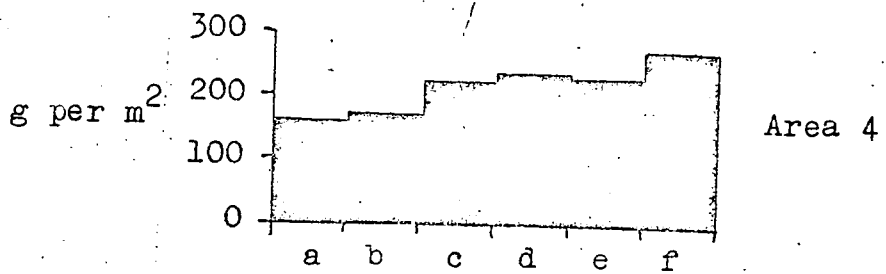
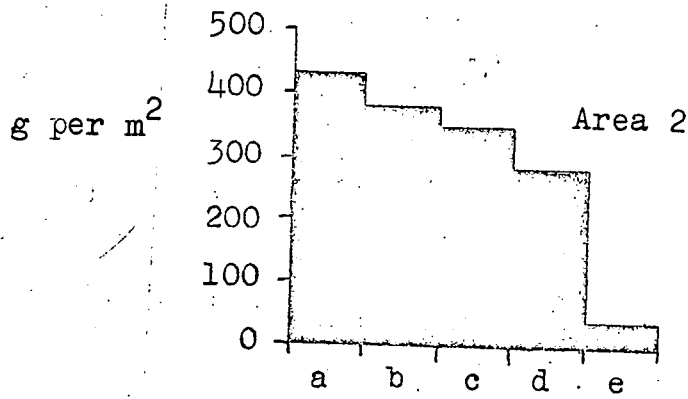
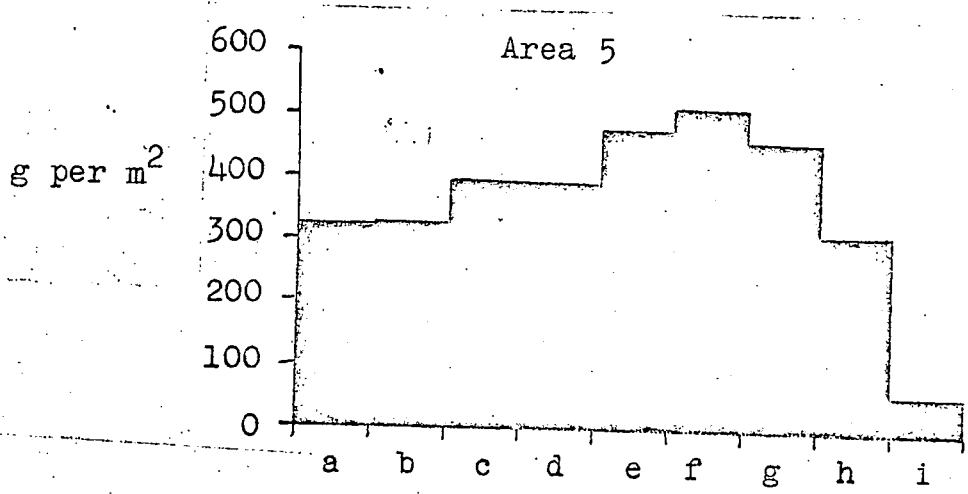

FIGURE 1.2 Potassium levels of the soil at areas 5, 2, 4 and 8

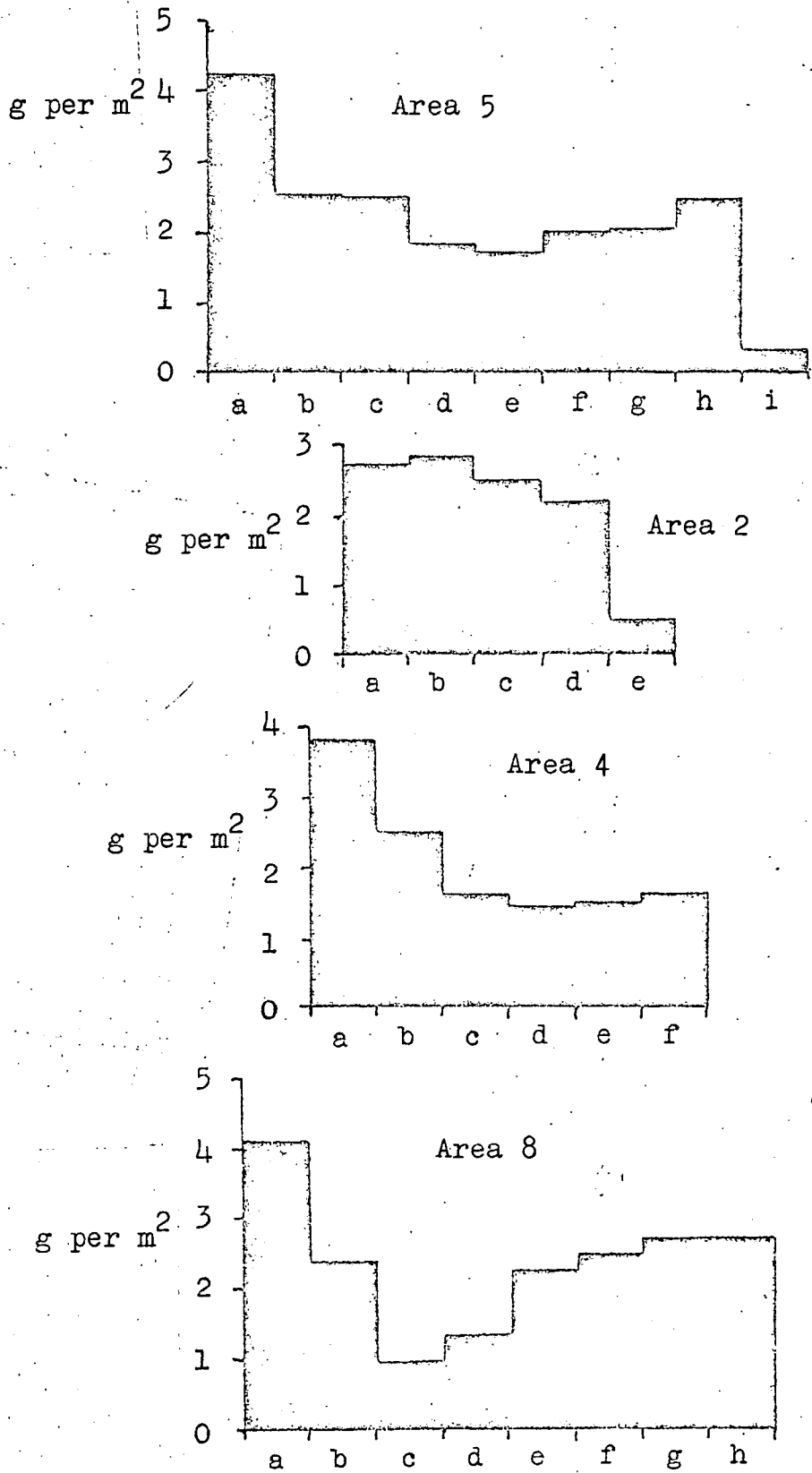

FIGURE 1.3 Sodium levels of the soil at areas 5, 2, 4 and 8

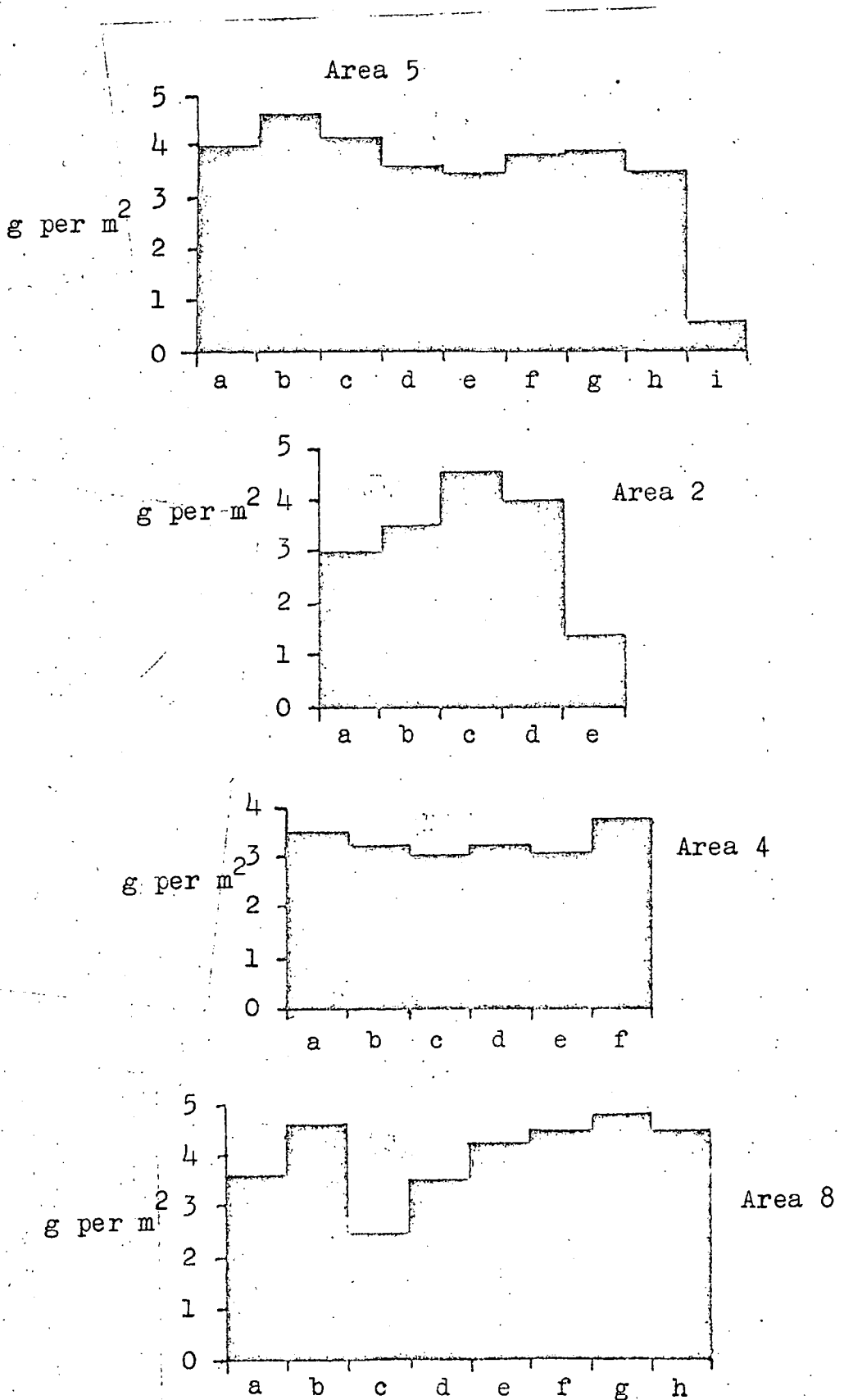

FIGURE 1.4 — Magnesium levels of the soil
at areas 5, 2, 4 and 8

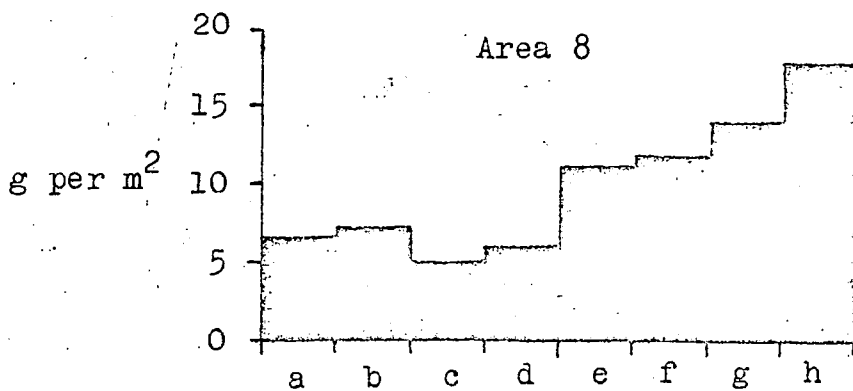
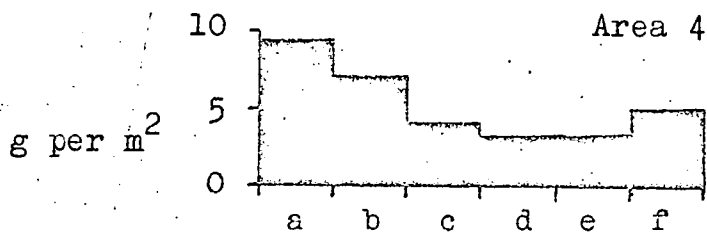
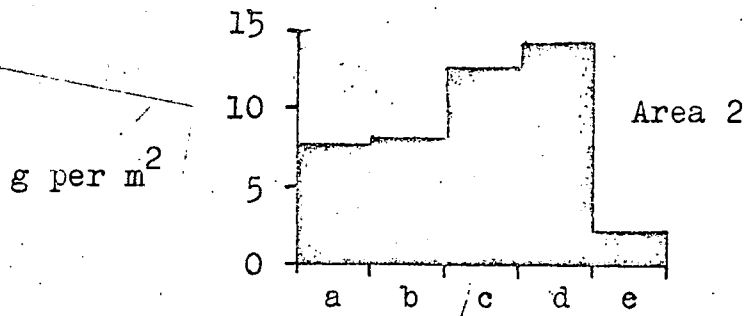
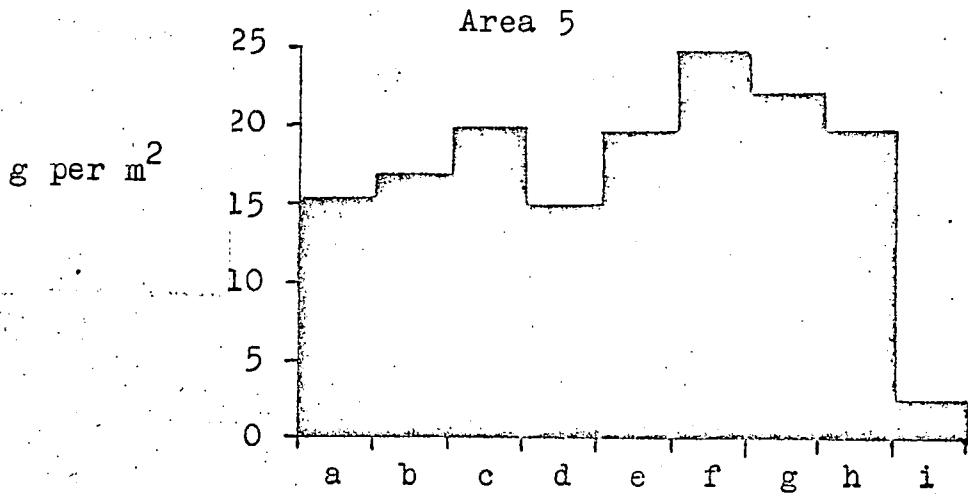

FIGURE 1.5 Calcium levels of the soil at areas 5, 2, 4 and 8

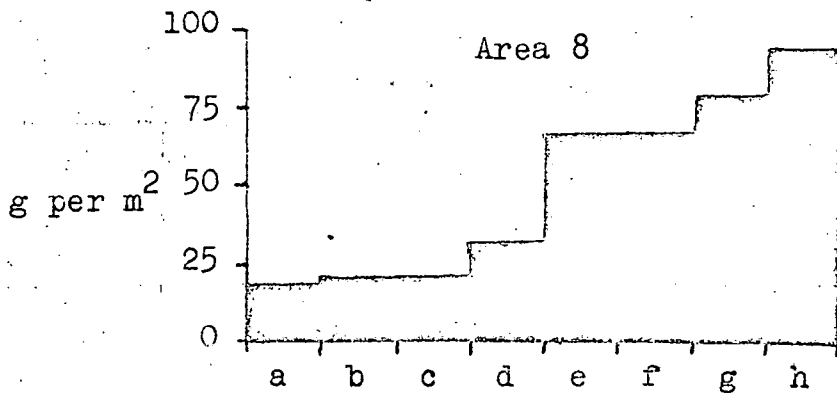
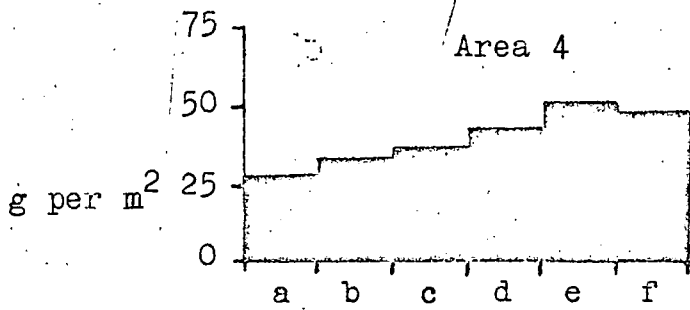
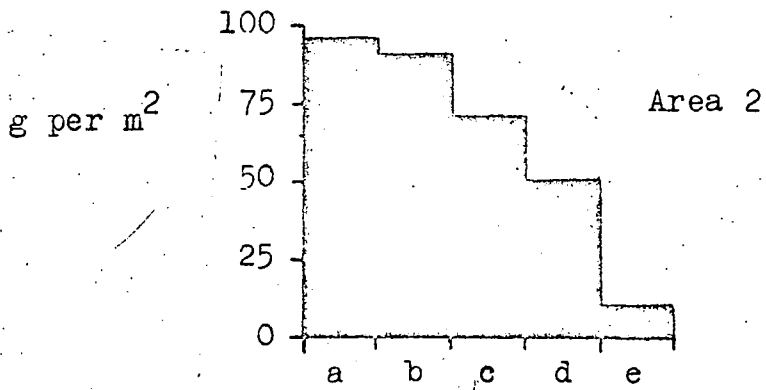
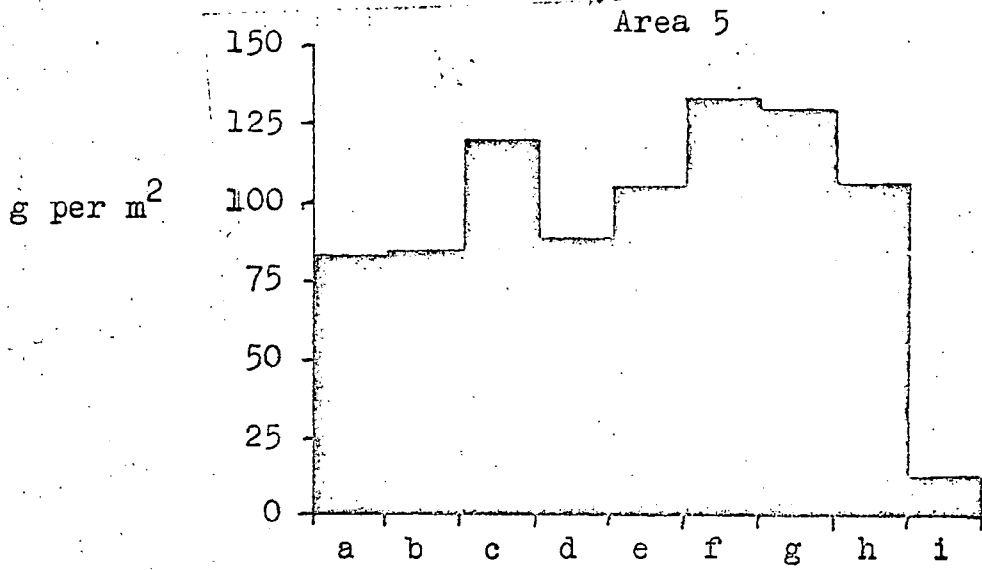

FIGURE 1.6 Phosphorus levels of the soil at areas 5, 2, 4 and 8 (log. scale)

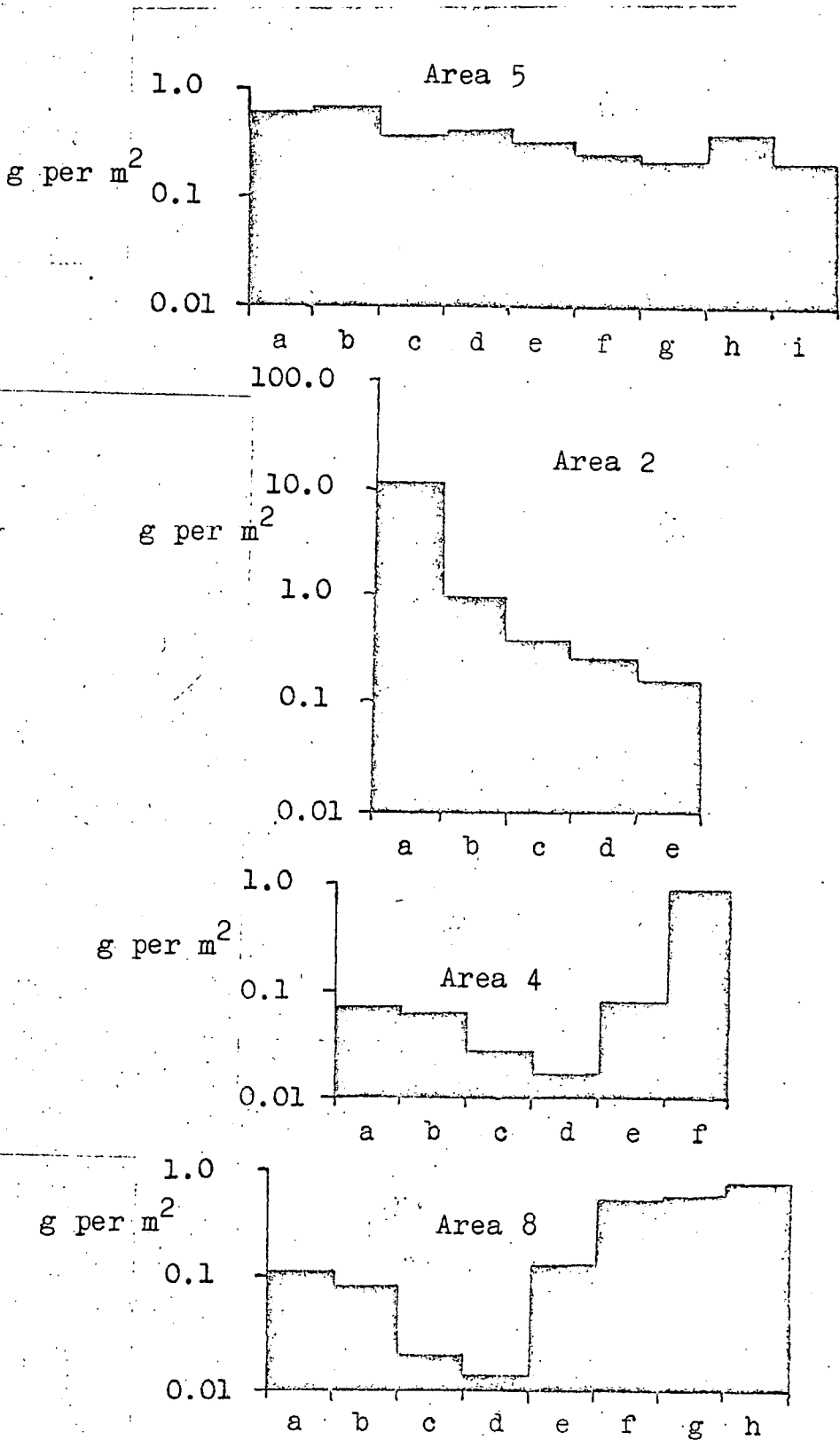

FIGURE 1.7 Nitrate nitrogen levels in the soil at areas 5, 2, 4 and 8

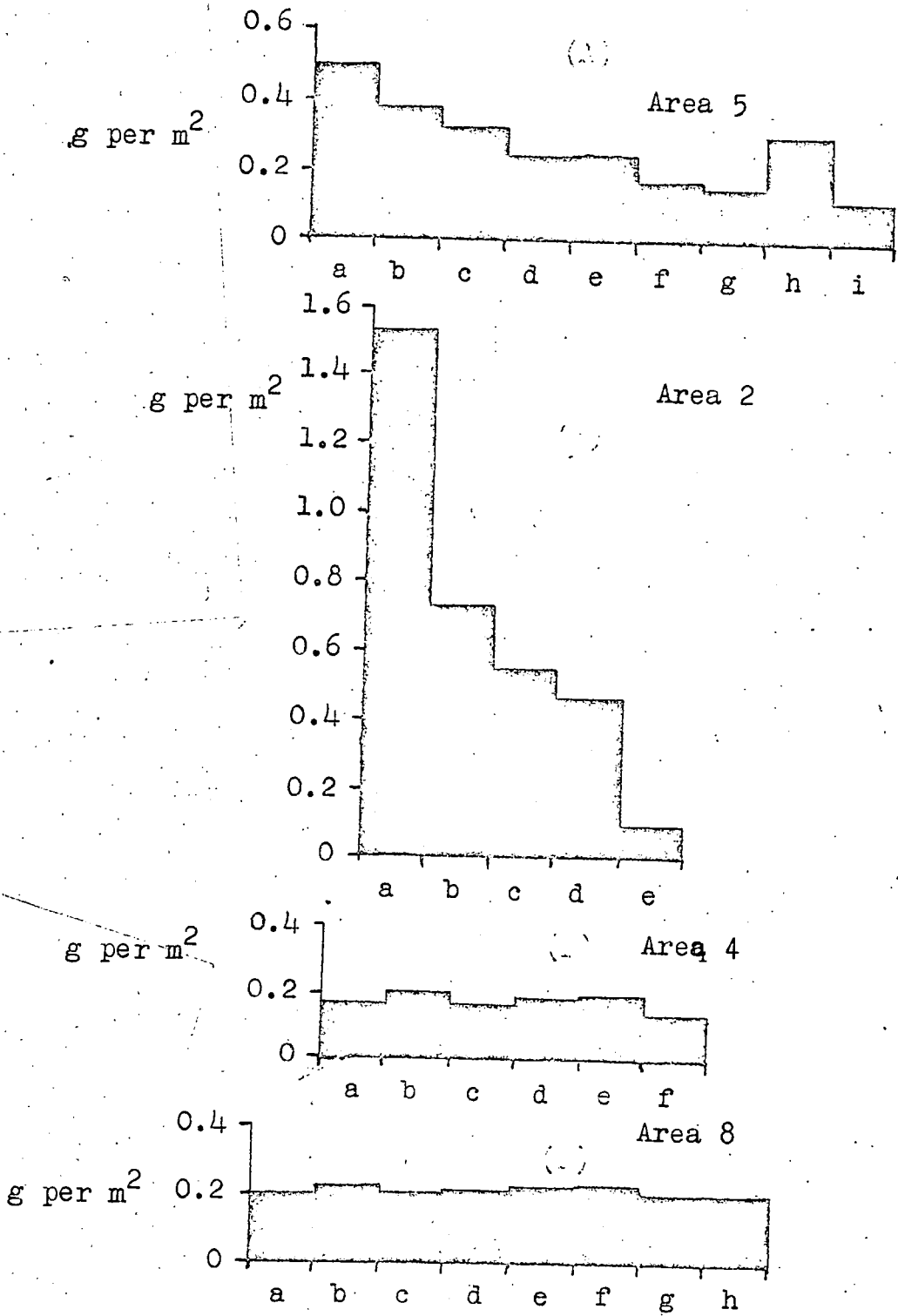

FIGURE 1.8 Percentage Water Content of soil samples from the six study areas.

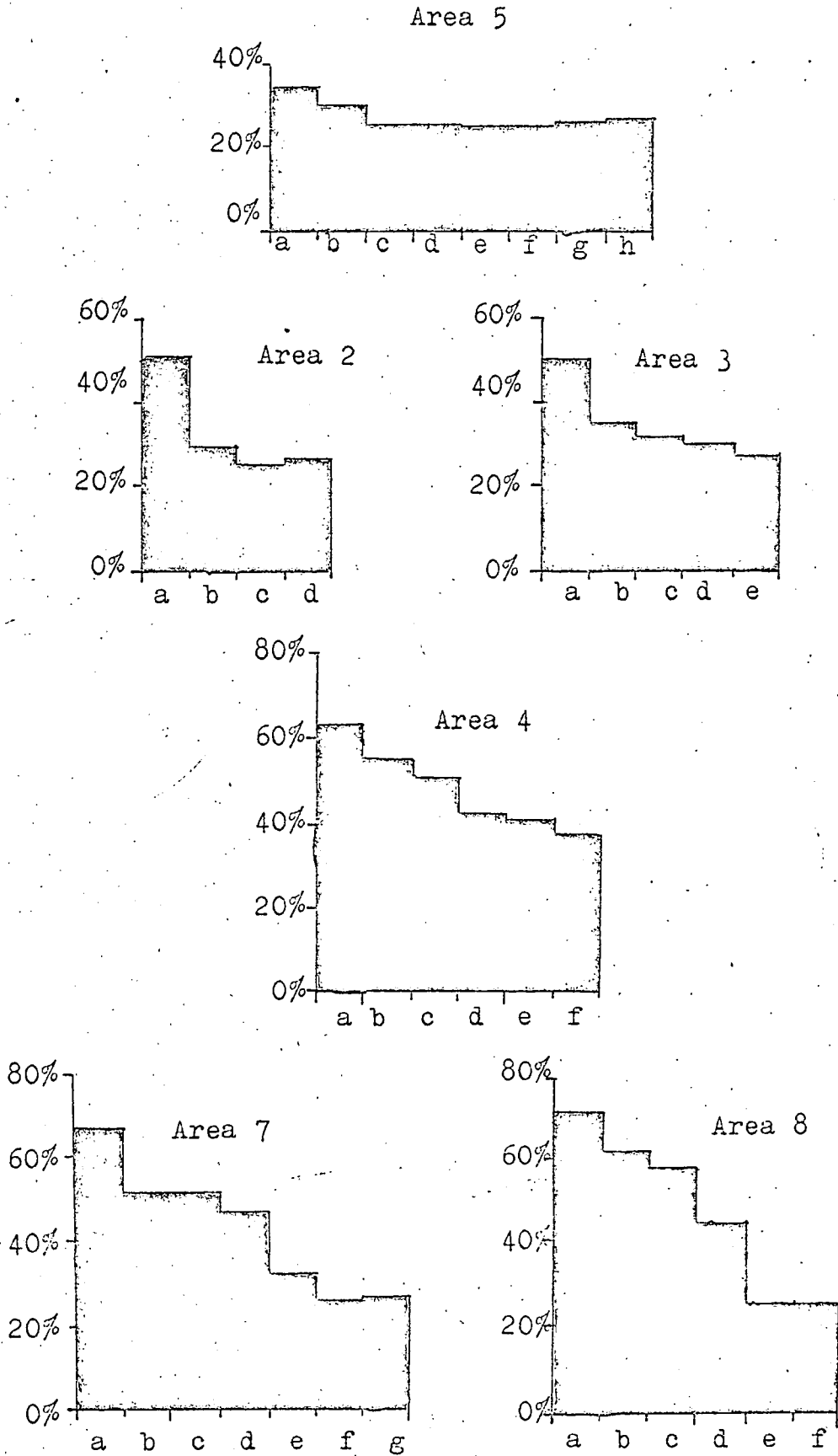

FIGURE 1.9 Percentage Organic Matter in soil samples from the six study areas.

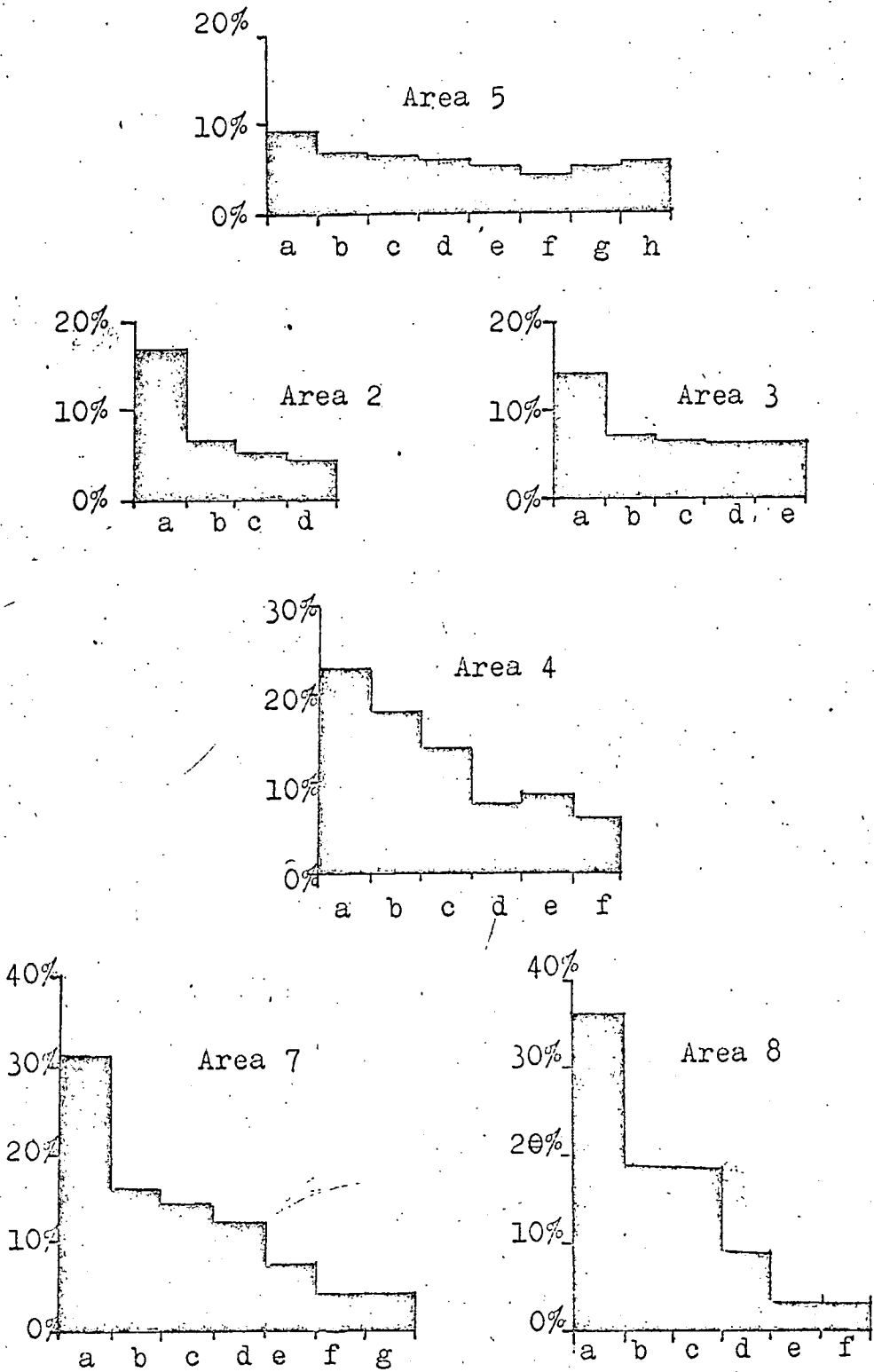
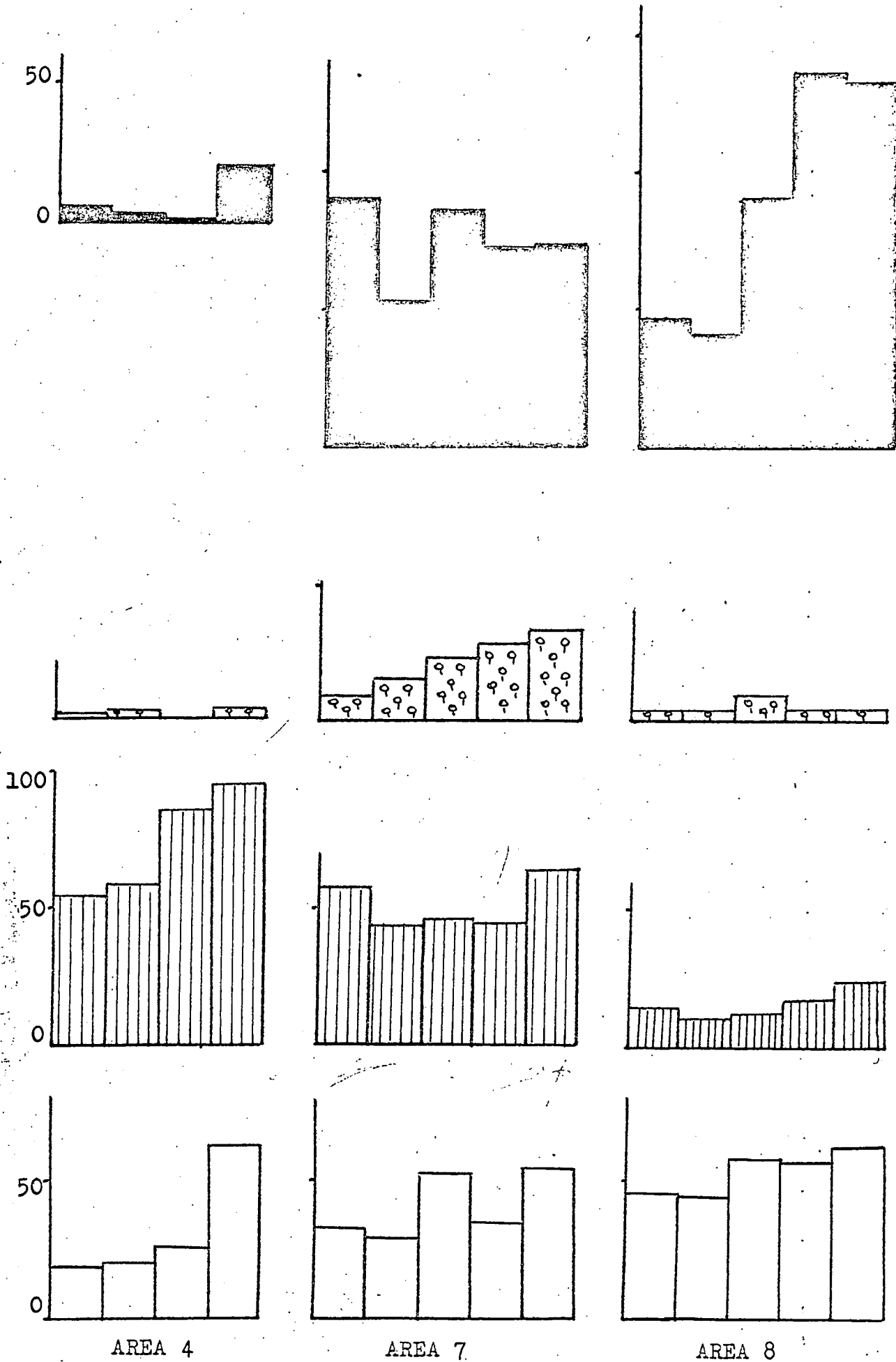

FIGURE 2.1 Dry weight (g per m²) of each component group of plants at each sample date. (see Table 2)



AREA 4

AREA 7

AREA 8

KEY

- Bryophytes..... [white box]
- Dicotyledons.. [box with circles]
- Sedges..... [box with vertical lines]
- Grasses..... [white box]

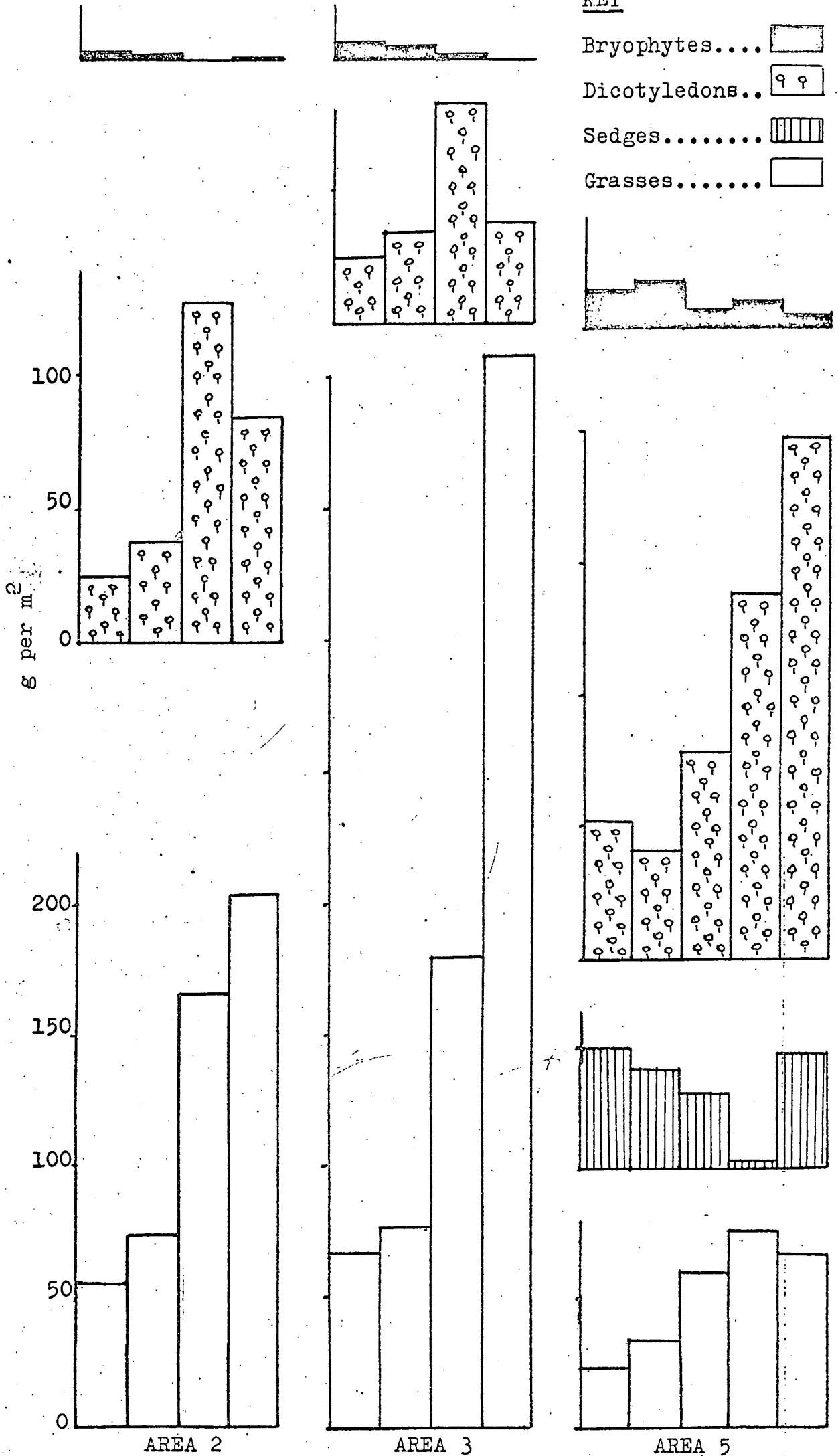

FIGURE 2.2 Total dry weight (g per m²) of living and dead plant material at each sample date.
(see Table 2)

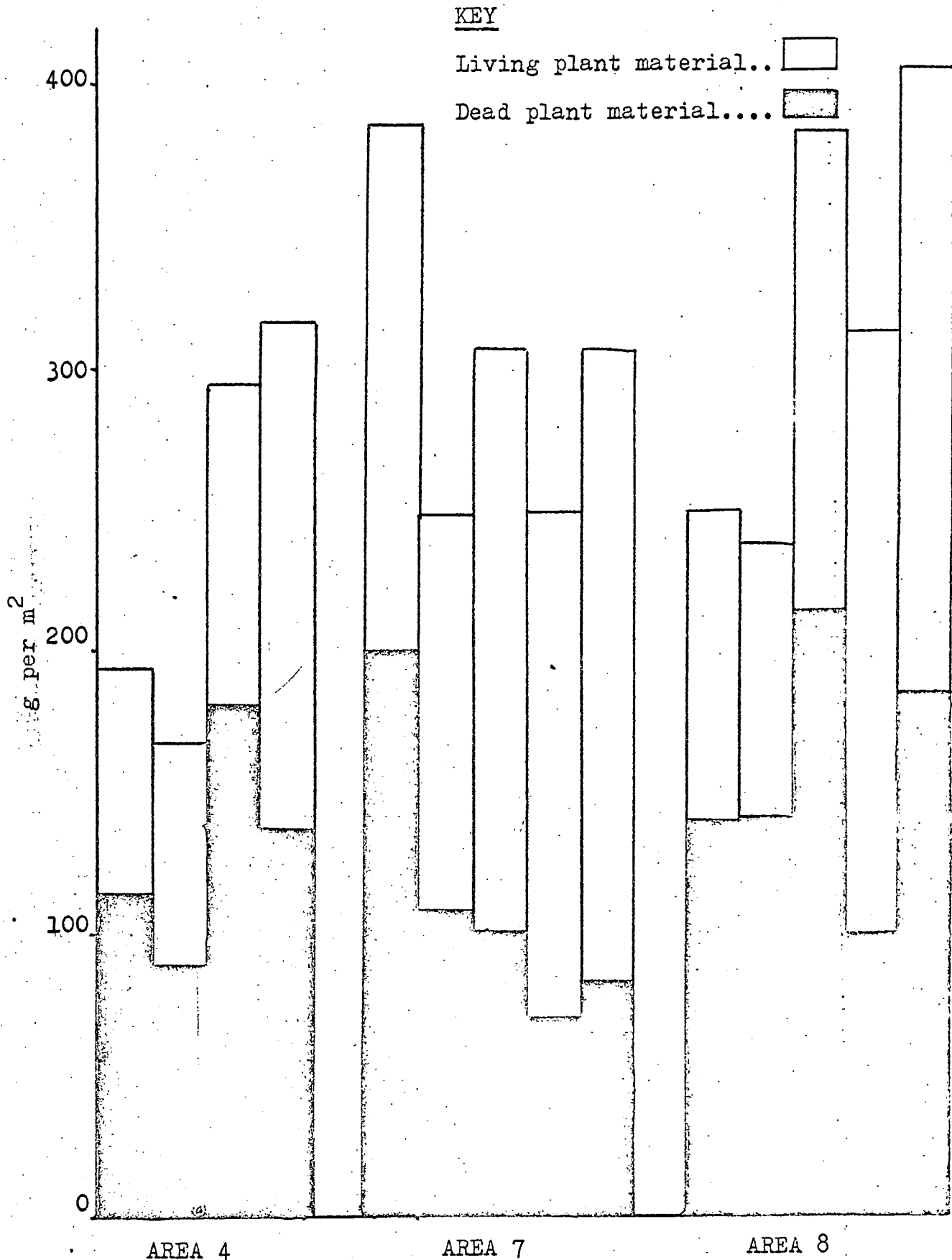
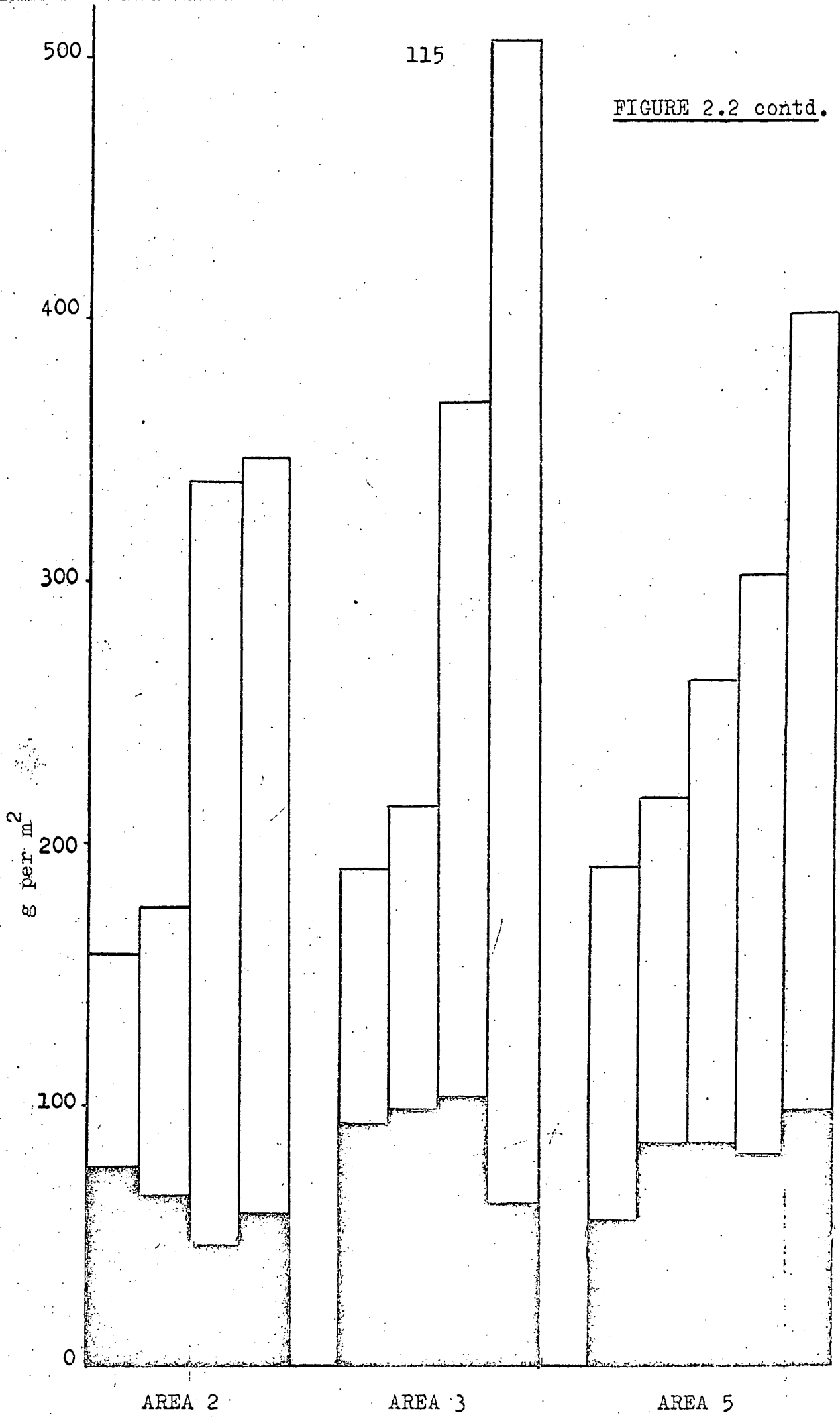

FIGURE 2.2 contd.



APPENDIX 3 Table 3.1

Number of Individuals of each Species per
Square Metre.

<u>SPECIES</u>	<u>AREA 2</u>	<u>AREA 3</u>	<u>AREA 4</u>	<u>AREA 5</u>	<u>AREA 7</u>	<u>AREA 8</u>
<i>Anthoxanthum odoratum</i>	108			404	317	249
<i>Holcus lanatus</i>	1309	338		825	779	124
<i>Poa trivialis</i>	2208	1736		853	174	
<i>Alopecurus pratensis</i>	706	805				
<i>Agrostis tenuis</i>	965					182
<i>Festuca rubra</i>	1316	6146		2931	1002	353
<i>Bromus mollis</i>	504	1242				
<i>Helictotrichon pubescens</i>		346		70		
<i>Agrostis canina</i>			32	611	1611	1279
<i>Molinia caerulea</i>			1814		115	210
<i>Poa pratensis</i>				116	38	
<i>Festuca ovina</i>					1106	806
<i>Briza media</i>					55	255
<i>Nardus stricta</i>					671	2732
<i>Cynosurus cristatus</i>				925		
<i>Carex pilulifera</i>			53			
<i>Carex pulicaris</i>			292		347	304
<i>Carex panicea</i>			350		237	247
<i>Carex caryophylllea</i>				115		
<i>Carex lepidocarpa</i>					23	
<i>Eriophorum angustifolium</i>			407		58	
<i>Juncus squarrosus</i>					353	
<i>Juncus articulatus</i>					41	
<i>Luzula campestris</i>				59	33	34
<i>Cerastium holosteodes</i>	334	267		178	16	
<i>Ranunculus bulbosus</i>	88	66		332	112	
<i>Conopodium majus</i>	191	90				
<i>Rumex acetosa</i>	136	143		57		
<i>Trifolium repens</i>	257			177	318	61
<i>Rhinanthus minor</i>	43	64		384		

APPENDIX 3 Table 3.1 contd.

<u>SPECIES</u>	<u>AREA 2</u>	<u>AREA 3</u>	<u>AREA 4</u>	<u>AREA 5</u>	<u>AREA 7</u>	<u>AREA 8</u>
<i>Achillea millefolium</i>		34				
<i>Potentilla erecta</i>			34	52	41	73
<i>Cardamine flexuosa</i>					43	
<i>Ranunculus flammula</i>					26	
<i>Campanula rotundifolia</i>					6	
<i>Taraxacum paludosum</i>				29	31	
<i>Prunella vulgaris</i>					69	
<i>Leontodon autumnalis</i>				19	23	
<i>Succisa pratensis</i>				7		
<i>Anemone nemorosa</i>				39		
<i>Plantago lanceolata</i>				721		
<i>Centaurea nigra</i>				110		
<i>Leontodon hispidus</i>				21		
<i>Trollius europaeus</i>				57		
<i>Euphrasia sp.</i>				161		
<i>Galium saxatile</i>						293
<i>Viola palustris</i>						39
other species	382	741	569	1661	204	583

The "performance" of 5 selected species

Species	Area	Day No.	Average dry weight of dead leaves perplant mg.	Average dry weight of live parts/plant mg.	Increase in dry weight of dead leaves between sampling times mg.	Increase in dry weight of live parts between sampling times mg.	Appendix 4	
HOLCUS LANATUS	Inside pen 2	1	21.1	7.4				
		5	14.3	7.8	-6.8	+0.4		
		28	14.8	15.9	+0.5	+8.1		
		72	11.7	130.1	+118.4	+114.1		
		82	13.5	139.7	+1.8	+9.6		
		97	20.1	158.9	+6.6	+19.2		
		Outside pen 2	1	13.7	4.9			
		7	9.5	5.2	-4.2	+0.3		
		15	10.2	8.6	+0.7	+3.4		
		20	10.2	10.0	0.0	+1.4		
28	12.5	12.7	+2.3	+2.7				
36	5.0	14.0	-7.5	+1.3				
55	8.7	59.7	+3.7	+45.7				
72	6.5	62.4	-2.2	+1.7				
3		1	10.8	3.3				
		7	10.9	5.0	+0.1	+1.7		
		15	12.7	6.4	+1.8	+1.4		
		20	13.0	7.4	+0.3	+1.0		
		28	4.4	10.9	-8.6	+3.5		
		36	5.6	10.2	+1.2	-0.7		
		55	4.0	45.2	-1.2	+35.0		
		72	5.8	38.6	+1.8	-6.6		
Inside pen 5		1	26.3	9.3				
		15	23.7	10.7	-2.6	+1.4		
		28	7.9	16.6	-15.8	+5.9		
		72	9.7	76.0	+1.8	+59.4		
		82	15.6	118.0	+5.9	+42.0		
		97	13.1	101.1	-2.5	-16.9		
Outside pen 5		1	22.0	4.3				
		7	6.6	7.7	-15.4	+3.4		
		15	12.0	8.4	+5.4	+0.7		
		20	15.4	12.0	+3.4	+4.6		
		28	10.4	16.3	-5.0	+4.3		
		36	14.4	19.2	+4.0	+2.9		
		55	16.2	37.3	+1.8	+18.1		
		72	9.1	54.4	-7.1	+17.1		
		82	8.5	44.8	-0.6	-19.6		
		91	16.2	138.2	+7.7	+93.4		
		97	10.7	65.4	-6.5	-72.8		

Inside	1	38.8	10.5		
pen 6	15	19.9	15.2	-18.9	+4.7
	36	16.0	30.0	-3.9	+14.8
	72	11.0	102.9	-5.0	+72.9
	82	11.1	121.3	+0.1	+18.4
	97	31.8	234.9	+20.7	+113.6

Outside	1	25.6	4.9		
pen 6	7	9.2	8.2	-14.4	+3.3
	15	7.4	8.7	-1.8	+0.5
	20	13.1	13.0	+5.7	+4.3
	28	12.0	17.0	-1.1	+4.0
	36	10.3	19.8	-1.7	+2.8
	55	9.5	52.3	-0.8	+32.5
	72	6.5	77.1	-3.0	+24.8
	82	11.6	88.7	+5.1	+11.6
	91	14.8	109.2	+3.2	+20.5
	97	13.0	111.0	-1.8	+1.8

Inside	1	11.2	5.6		
pen 7	5	8.3	7.2	+7.1	+1.6
	36	11.6	10.0	+3.3	+2.8
	72	10.6	77.6	-1.0	+67.6
	82	13.7	101.1	+3.1	+23.5
	97	16.8	88.1	+3.1	-13.0

Outside	1	18.2	6.6		
pen 7	9	10.5	4.4	-7.7	-2.2
	15	7.2	8.0	-3.3	+3.6
	20	8.7	6.9	+1.5	-1.1
	34	5.9	6.5	-2.8	-0.4
	55	9.3	22.1	+3.4	+15.6
	72	8.5	60.3	-0.8	+48.2
	82	11.4	81.5	+2.9	+21.2
	91	9.2	51.8	-2.2	-29.7
	97	10.6	74.8	+1.4	+23.0

Inside	1	7.8	7.2		
pen 8	15	12.3	8.2	+4.5	+1.0
	36	23.5	27.8	+11.2	+19.6
	82	16.8	72.4	-6.7	+44.6
	97	21.8	37.9	+5.0	-34.5

Outside	1	14.5	3.5		
pen 8	20	11.9	11.7	-3.4	+8.2
	36	7.7	11.1	-4.2	-0.6
	55	8.8	23.5	+1.1	+13.4
	72	7.9	26.4	-0.9	+2.9
	91	12.1	70.3	+4.2	+43.9
	97	19.2	44.4	+7.1	-25.9

FESTUCA	Inside	1	3.8	6.8		
RUBRA	pen	15	5.7	7.1	+1.9	+1.7
		28	4.3	8.0	-1.4	+0.9
		72	4.6	21.4	+0.3	+13.4
		82	3.4	20.3	-1.2	-1.1
		97	6.9	25.1	+3.5	+4.8

Outside	1	3.9	4.1		
pen 2	7	4.7	4.7	+0.8	+0.6
	15	6.4	5.9	+1.7	+1.2
	20	4.5	4.8	-0.9	-1.1
	28	4.8	9.0	+0.3	+4.2
	36	5.9	12.5	+1.1	+3.5
	55	2.4	10.0	-3.5	-2.5
	72	5.1	17.9	+2.7	+7.9

FESTUCA	1	3.1	3.3	3.2		
RUBRA	7	4.7	4.2	4.4	+1.2	+0.1
	15	3.4	3.4	3.7	-0.7	-0.1
AREA 3	20	6.5	7.6	7.6	+3.9	+0.6
	28	1.2	3.2	3.2	-4.4	-0.7
	36	3.2	5.2	5.2	+2.0	+0.2
	55	5.9	10.9	10.9	+5.7	+0.1
	72	3.3	7.7	7.7	-3.2	-0.2

Inside	1	4.2	6.0		
pen 5	15	7.2	8.3	+3.0	+2.3
	28	2.4	7.0	-4.8	-1.3
	72	6.5	15.0	+4.1	+8.0
	82	4.6	14.5	-1.9	-0.5
	97	4.9	20.5	+0.3	+6.0

Outside	1	6.3	5.5		
pen 5	7	5.9	6.2	-0.4	+0.7
	15	4.5	8.1	-1.4	+1.9
	20	5.9	11.0	+1.4	+2.9
	28	4.7	8.8	-1.2	-2.2
	36	5.0	7.5	+0.3	-1.3
	55	6.7	9.8	+1.7	+2.3
	72	9.2	10.6	+2.5	+0.8
	82	3.8	13.2	-5.4	+2.6
	91	11.8	28.8	+8.0	+15.6
	97	4.7	14.2	-7.1	-14.6

Outside	1	7.7	9.3		
pen 6	15	10.9	12.1	+3.2	+2.8
	36	6.2	18.8	-4.7	+6.7
	72	6.8	16.8	+0.6	-2.0
	82	4.2	24.6	-2.6	+7.8
	97	5.3	22.4	+1.1	-2.2

Outside	910	9.0	7.7		
pen 6	7	6.2	7.5	-2.8	-0.2
	15	6.4	7.6	+0.4	+0.1
	20	4.7	7.1	-1.7	-0.5
	28	5.2	12.9	+0.5	+5.8
	36	12.5	18.4	+7.3	+5.5
	55	3.1	9.3	-9.4	-9.1
	72	10.6	24.3	+7.5	+15.0
	82	3.1	17.4	-7.5	-6.9
	91	8.2	28.1	+5.1	+10.7
	97	4.6	18.0	-3.6	-10.0

Inside	1	6.5	8.1		
pen 7	15	8.6	9.7	+2.1	+1.6
	36	15.4	14.3	+6.8	+4.6
	72	9.7	24.6	-5.7	+10.3
	82	6.8	24.4	-2.9	-0.2
	97	7.5	32.4	+0.7	+8.0

Outside	1	6.8	5.0		
pen 7	9	5.8	4.3	-1.0	-0.7
	15	5.9	9.8	+0.1	+5.5
	20	5.7	7.1	-0.2	-2.7
	34	4.6	6.9	-1.1	-0.2
	55	9.4	18.1	+4.8	+11.2
	72	3.3	12.9	-6.1	-5.2
	82	5.2	15.6	+1.9	+2.7
	91	3.2	27.2	-2.0	+11.6
	97	8.4	24.2	+5.2	-3.0

Outside	9	6.2	6.7		
pen 8	36	22.7	19.2	+16.5	+12.5
	82	9.0	23.3	-13.7	+4.1

ANTHOXANTHUM	Outside	1	15.7	7.7		
ODORATUM	pen 2	7	18.7	3.8	+3.0	-3.7
		20	19.7	15.4	+1.0	+11.6
		28	13.0	12.6	-6.7	-2.8
		36	3.9	18.9	-9.1	+5.3
		55	1.6	20.9	-2.3	+2.0
		72	2.2	51.9	+0.6	+31.0

3	7	25.2	9.3		
	20	9.2	12.7	+3.4	-2.0
	36	2.1	12.2	-0.5	-0.5

Inside	1	11.8	9.1		
pen 5	15	16.4	12.0	+4.6	+2.9
	28	7.5	18.6	-8.9	+6.6
	72	3.2	68.1	-4.3	+49.5
	82	4.3	40.1	+1.1	-28.0
	97	7.5	71.0	+3.2	+30.9

Outside	1	16.5	9.9		
pen 5	7	14.5	7.3	-2.0	-2.7
	15	10.8	10.1	-3.7	+2.8
	28	9.5	15.7	-1.3	+5.6
	36	8.1	19.1	-1.4	+3.4
	55	5.4	41.8	-2.7	+22.7
	72	7.1	45.4	+1.7	+3.6
	82	7.6	48.4	+0.5	+3.0
	91	10.4	94.9	+2.8	+46.5
	97	7.1	54.8	-3.5	-40.1

Inside	1	16.5	4.1		
pen 6	15	14.1	14.3	-2.4	+10.2
	36	7.1	24.6	-7.0	+10.3
	72	4.7	55.7	-2.4	+31.1
	82	4.5	78.8	-0.2	+23.1
	97	11.6	122.4	+7.1	+43.6

Outside	7	14.2	11.0		
pen 6	15	12.4	12.6	-1.8	-1.6
	20	10.9	14.2	-1.5	+1.6
	28	11.2	20.5	+0.3	+6.3
	36	12.8	28.5	+1.6	+8.0
	55	9.7	34.7	-3.1	+6.2
	72	3.3	57.0	-6.4	+22.3
	82	4.0	80.9	+0.7	+23.9
	91	12.2	108.7	+8.2	+27.8
	97	7.1	80.4	-5.1	-28.3

Inside	1	7.3	8.5		
pen 7	15	8.0	8.8	+0.7	+0.3
	36	9.3	19.6	+1.3	+10.8
	82	6.8	46.2	-2.5	+26.6
	97	12.6	40.5	+5.8	-5.7

Outside	1	10.0	4.0		
pen 7	9	7.3	5.1	-2.7	+1.1
	15	6.2	12.0	-1.1	+6.9
	20	6.9	10.5	+0.7	-1.5
	34	4.4	7.8	-2.5	-2.7
	55	5.5	41.1	+1.1	+33.3
	82	9.2	79.5	+3.7	+38.4
	91	7.9	39.3	-1.3	-40.2
	97	9.4	56.9	+1.5	+17.6

Inside	1	11.4	7.0		
pen 8	15	13.7	9.9	+2.3	+2.9
	36	6.0	15.9	-7.7	+6.0
	72	7.1	53.7	+1.1	+37.8
	82	6.5	61.7	-0.6	+8.0
	97	5.4	55.4	-1.1	-6.3

Outside	1	15.4	11.5		
pen 8	9	12.7	7.3	-2.7	-3.2
	15	4.5	10.7	-8.2	+3.4
	20	15.1	12.3	+10.6	+1.6
	36	15.1	15.7	-	+3.4
	55	15.7	63.6	+0.6	+47.9
	72	18.3	60.7	+2.6	-2.9
	82	6.7	55.5	+11.6	-5.2
	91	10.4	48.5	+3.7	-7.0
	97	7.7	62.2	-2.7	+13.7

ANTHOXANTHUM
ODORATUM

Inside					
pen 2	1	20.0	9.7	-5.0	+17.7
	15	15.0	27.4	-0.7	+ 4.4
	28	14.3	31.8	-5.9	+29.4
	72	8.4	61.2	-1.5	+40.7
	97	6.9	101.9		

SPECIES	AREA	Day No.	Dryweight per plant mgm	Increase in dry weight/plant	Rate of increase mgm/day	Increase between day 1 and 72	Rate of increase between day 1 and 72 mgm per day
RHINANTHUS MINOR	2 out	1	0.6				
		7	1.9	+1.3	+0.2		
		15	4.0	+2.1	+0.3		
		20	8.0	+4.0	+0.8		
		28	8.0				
		36	33.7	+25.7	+3.2		
		55	88.8	+55.1	+2.9		
		72	214.9	+126.1	+7.4	214.3	3.0
	3	1	0.4				
		7	1.3	+0.9	+0.1		
		15	3.4	+2.1	+0.3		
		20	5.9	+2.5	+0.5		
		28	7.2	+1.3	+0.2		
		36	19.2	+12.0	+1.5		
		55	120.6	+101.4	+5.3		
		72	147.1	+26.5	+1.5	146.7	2.0
	Inside pen 5	1	0.4				
		15	1.3	+0.9	+0.1		
		28	2.9	+1.6	+0.1		
		72	71.5	+68.6	+1.6		
		82	106.3	+34.8	+3.5	105.9	1.5
	Outside pen 5	1	0.5				
		7	1.1	+0.6	+0.1		
		15	1.9	+0.8	+0.1		
		20	1.5	-0.4	-0.1		
		28	2.5	+1.0	+0.1		
		36	6.7	+4.2	+0.5		
		55	36.4	+29.7	+1.6		
		72	59.1	+22.7	+1.3		
		82	78.1	+19.0	+1.9		
		91	137.7	+59.6	+6.6		
		97	133.5	-4.2	-0.7	58.6	0.8
	Outside pen 6	1	0.5				
		7	1.3	+0.8	+0.1		
		15	2.2	+0.9	+0.1		
		20	3.8	+1.6	+0.3		
		28	3.8				
		36	11.2	+7.4	+0.9		
		55	48.3	+37.1	+2.6		
		72	169.4	+121.1	+7.2		
		82	336.3	+166.9	+16.7		
		91	561.4	+225.1	+25.0		
		97	424.1	-137.3	-22.9	168.9	2.3

SPECIES	AREA	DAY	D.W./PLANT	INC. IN D.W.	RATE OF INC.
TROLLIUS EUROPEAUS	Outside pen 5	1	70.4		
		7	92.4	+22.0	+3.1
		15	198.3	+95.9	+12.0
		20	258.5	+60.2	+12.0
		28	363.7	+105.2	+13.1
		36	508.5	+144.8	+18.1
		55	1191.2	+682.7	+36.5
		72	1382.3	+191.1	+11.4
		82	1642.0	+259.7	+26.0
		91	1180.0	-462.0	-51.3
		97	1174.2	-5.8	-0.1

Outside pen 5

Rate of growth between day 1 and day with maximum dry weight (82)=
 $\frac{(1642.0 - 70.4)}{82}$ mgm per day = 19.2 mgm per day.

Outside pen 6	1	52.4		
	7	101.0	+48.6	+6.9
	15	183.2	+82.2	+10.3
	20	180.2	-3.0	-0.6
	28	456.9	+276.7	+34.6
	36	640.0	+183.0	+22.9
	55	857.3	+217.3	+12.1
	72	1769.9	+892.6	+52.5
	82	1775.6	+5.7	+0.6
	91	1823.3	+47.7	+5.5
	97	1812.9	+10.4	-1.7

Outside pen 6

Rate of growth between dayland day with maximum dry weight (91)=
 $\frac{(1823.3 - 52.4)}{91}$ mgm per day = 19.5 mgm per day.

	SODIUM			POTASSIUM			MAGNESIUM			CALCIUM					
AREA 2	24.5	7.6	21.6	11.7	5.8	24.5	7.6	21.6	11.7	5.8	24.5	7.6	21.6	11.7	5.8

Holcus lanatus	1.0	4.1	3.0	3.1	27.8	34.6	13.6	18.3	2.4	3.0	2.1	1.8	4.2	5.0	4.9	2.2
Poa trivialis	0.6	1.6	1.4	1.3	25.2	23.4	22.4	21.3	2.1	2.6	2.8	3.4	3.7	4.4	7.6	4.5
Alopecurus pratensis	3.1	1.7	1.3	1.3	30.4	29.3	21.8	19.3	2.3	1.9	1.7	2.5	3.7	2.8	2.3	2.9
Agrostis tenuis	2.3	5.9	2.7	1.8	20.3	21.8	21.0	14.7	3.6	3.3	3.2	2.0	4.9	3.0	4.9	2.1
Festuca rubra	0.7		0.9	0.5	23.0	21.1	26.8	15.8	1.5		2.2	1.6	2.8	3.0	4.5	2.3
Bromus mollis		3.1	1.9	2.4		14.8	12.9	8.7		2.9	2.1	2.3		3.4	2.9	2.7
Ranunculus bulbosus	0.6	5.2	5.2	6.8	9.3	15.8	12.2	12.5	1.6	4.7	4.3	5.1	2.4	4.8	8.6	10.3
Rumex acetosa	9.2	5.6	2.3	2.2	43.7	22.2	20.1	15.3	8.1	5.3	4.8	4.2	13.7	6.4	5.4	4.6
Trifolium repens	1.7	4.1		6.4	28.4	20.8		16.4	4.4	4.1		4.1	11.3	11.0		8.5
Rhinanthus minor		4.0	1.2	3.4		30.8	22.4	15.0		4.3	3.5	4.5		10.0	7.4	7.5
Debris	0.7	1.0	1.6	1.7	5.4	6.8	8.8	6.2	2.2	2.3	2.8	3.1	3.9	5.8	11.3	6.8

AREA 3

Holcus lanatus	3.6		3.1	2.5	18.6	2	20.2	17.0	3.3		2.7	2.6	18.1		7.2	6.9
Poa trivialis	1.0	1.3	1.0	0.5	21.3	25.3	19.2	19.0	3.2	4.2	3.2	3.0	21.3	20.6	12.4	6.5
Alopecurus pratensis	2.2	0.7	2.4	1.0	14.7	14.7	22.4	14.9	3.5	2.9	3.1	5.4	20.7	11.9	6.7	12.7
Festuca rubra	0.8	0.5	0.6	0.4	22.9	17.4	30.7	20.2	2.3	1.9	2.5	1.9	16.6	9.9	5.9	3.9
Bromus mollis		2.3	1.3	1.2		9.4	9.4	5.0		5.3	6.8	2.2		9.8	7.8	4.8
Helictotrichon pubescens	0.5		0.5	0.2	22.8		17.1	10.3	2.7		2.1	1.1	12.9		9.8	3.1
Ranunculus bulbosus	5.0	8.0	2.2	5.2	14.1	17.6	8.2	10.1	3.1	12.4	2.0	5.8	12.1	22.9	17.4	18.1
Rhinanthus minor		1.5	1.7	0.7		23.5	15.3	17.2		5.7	6.0	3.7		31.3	26.6	6.1
Cerastium holostoides		3.0	3.1	1.2		27.2	24.1	21.5		5.7	5.2	3.4		26.2	22.9	7.9
Debris	0.9	1.7	1.6	0.3	3.5	7.1	4.0	4.7	2.1	2.7	8.8	2.0	15.8	10.3	20.9	11.0

AREA 4

Molinia caerulea	1.0	0.9		0.3	19.4	14.9		9.5	1.7	2.2		2.8	13.4	10.2		1.8
Eriophorum angustifolium	1.1	0.8		1.7	18.9	15.3		8.5	2.8	3.0		3.0	7.1	7.9		3.5
Carex panicea	1.0	1.0		0.4	18.5	21.5		12.4	3.8	4.1		3.7	11.7	14.7		4.7
Debris	0.6	0.7		0.6	1.9	1.5		1.4	1.6	2.7		2.4	9.3	12.8		5.5

Table 5.1 contd.

	SODIUM			POTASSIUM			MAGNESIUM			CALCIUM											
AREA 5																					
Anthoxanthum odoratum	24.5	7.6	21.6	11.7	5.8	24.5	7.6	21.6	11.7	5.8	24.5	7.6	21.6	11.7	5.8						
Holcus lanatus		1.5	1.1	2.4	0.9		19.0	11.0	13.9	14.7	3.7	2.6	4.0	2.9	14.9	6.4	9.9	4.9			
Poa trivialis			3.3	3.4	2.3		16.3	10.8	17.1		4.6	3.8	3.7		17.8	11.1	6.7				
Festuca rubra	0.4	1.1	0.5	0.8	0.9		13.1	17.5	17.4		4.0	4.4	4.1		7.1	11.5	6.2				
Ranunculus bulbosus	2.0	1.3	2.2	4.2	7.9	21.0	21.3	14.2	12.9	6.3	2.3	2.5	4.0	7.2	3.4	3.1	1.7	11.2	6.6	17.3	5.1
Cynosurus cristatus			2.5	3.0	2.4		13.0	14.2	17.4	13.1		2.1	2.3	2.5	3.0	3.0		3.1	5.4	8.4	4.6
Rumex acetosa			1.9	2.0	2.3		14.7	9.6	14.0			7.6	5.8	9.2		9.2			18.0	14.4	11.8
Trifolium repens			2.1	3.2	3.4		9.2	11.6	10.9			6.0	7.2	5.1		5.1			28.4	19.5	9.7
Plantago lanceolata	3.1	4.3	7.4	6.6	5.0	8.0	16.4	7.3	6.3	5.0	13.8	8.3	13.4	7.1	5.0	6.7	15.2	24.0	11.1	9.0	
Debris	0.5	0.8	1.5	1.2	0.8	6.1	4.4	3.7	2.9	3.2	3.1	2.8	3.6	3.4	4.8	8.7	5.0	19.2	14.1	11.1	
AREA 7																					
Anthoxanthum odoratum		0.7	0.9	1.0			20.5	18.8	19.6		3.5	4.0	2.1		6.9	7.7	7.0				
Holcus lanatus		1.0	1.6	1.3			28.5	19.9	21.5		3.9	3.5	2.1		7.4	3.1	9.7				
Festuca rubra		0.4	0.7	0.7			14.8	15.5	18.5		2.4	2.7	4.1		3.3	2.3	9.8				
Nardus stricta	1.1	0.8	0.3	0.5	0.6	10.6	7.7	15.9	10.5	8.6	3.4	1.7	1.8	2.0	1.7	14.9	2.5	2.2	2.1	3.2	
Carex pulicaris		0.9	0.6	0.6			10.4	15.9	18.1		3.8	3.6	3.2		3.5	6.4	5.9				
Carex panicea	1.2	1.0	0.5	0.6	1.1	18.7	17.7	20.2	21.2	15.3	4.8	3.8	3.0	3.5	3.4	21.1	5.1	2.8	5.3	10.2	
Juncus squarrosus	4.3	4.0	1.1	2.5	1.1	5.9	9.3	14.2	13.3	9.2	2.9	2.5	2.2	1.8	1.0	1.6	1.3	3.8	1.0	2.6	
Ranunculus bulbosus	9.9		4.0		1.8	12.1	26.0		15.8	8.0		6.7		6.5	9.4		18.3		25.5		
Trifolium repens		3.2	1.9	3.1	1.7		12.8	17.0	12.7	16.9		7.2	10.9	6.9	13.3		9.2	19.0	6.7	23.5	
Rhytidadelphus squarrosus		0.7	0.7	0.6	0.6		5.6	4.2	5.9			2.9	2.8	3.2		8.7		8.7	2.8	11.5	
Acrocladium cuspidatum	0.8	1.0	0.8	0.7	0.8	5.1	5.2	6.6	5.7	7.7	3.8	3.7	3.2	3.2	5.3	17.1	6.3	10.6	6.1	24.3	
Debris	1.5	0.7	0.7	0.6	0.6	2.8	2.1	5.0	2.8	4.5	2.4	2.4	3.4	2.0	1.8	4.5	3.6	3.2	6.0	9.3	
AREA 8																					
Festuca ovina	1.4	0.7		1.2		11.3	11.5		6.5		2.1	1.3		2.1		17.8	1.7		4.0		
Nardus stricta	0.8	1.1	0.6	1.9	2.0	10.9	10.3	11.8	7.6	6.1	1.5	1.6	1.4	1.4	1.0	0.9	0.8	3.5	2.4	1.9	
Agrostis canina	1.9	2.1	1.1	0.7	1.9	13.6	14.6	12.0	11.3	10.4	3.2	2.3	2.5	2.0	2.8	7.9	2.4	8.1	4.7	8.7	
Carex panicea	2.0	0.5	0.7	0.6	0.6	19.7	17.3	10.7	13.7	9.5	3.3	2.8	2.2	3.4	3.2	8.7	2.1	8.0	3.0	9.5	
Thuidium tamariscinum	0.9	1.0	0.8		0.8	5.9	4.4	3.9		5.4	2.8	1.9	2.5		2.8	13.3	3.0	15.6		12.4	
Hypnum cupressiforme	0.6	0.7	1.1		0.5	2.8	4.8	4.8		3.8	1.2	2.1	3.1		2.0	9.6	2.6	23.0		9.5	
Rhytidadelphus squarrosus	1.1	0.4	0.6	1.0	0.9	3.3	3.5	4.6	4.3	5.3	2.3	1.5	2.2	2.5	2.3	14.0	2.3	10.6	8.3	11.0	

AREA 2 24.5 7.6 21.6 11.7 5.8 24.5 7.6 21.6 11.7 5.8 24.5 7.6 21.6 11.7 5.8 24.5 7.6 21.6 11.7 5.8 24.5 7.6 21.6 11.7 5.8

Holcus lanatus	6.3	36.1	105.7	195.2	174.8	226.4	141.0	1163.6	15.0	26.0	73.6	112.5	26.4	44.1	175.0	141.2
Poa trivialis	3.8	9.6	15.3	7.7	161.8	139.4	244.8	122.2	13.4	15.3	30.3	19.9	23.9	26.1	82.4	25.9
Alopecurus pratensis	35.8	38.7	72.4	87.0	346.6	651.1	1194.8	1292.4	26.8	41.4	90.5	168.0	42.1	62.0	126.6	192.8
Agrostis tenuis	14.8	82.2	43.0	45.6	131.5	305.2	331.9	384.2	23.1	46.6	50.8	52.1	31.5	69.8	76.8	54.4
Festuca rubra	5.2		6.0	3.6	170.0		184.6	109.3	10.9		15.3	11.3	20.7	30.8	16.0	
Bromus mollis			92.5	54.6		301.5	631.0	196.3			58.1	101.8	51.0	68.8	142.1	61.9
Ranunculus bulbosus	55.7	583.0	626.1	1302.3	836.4	1694.3	1473.9	2380.1	146.6	527.2	518.2	967.0	215.9	546.6	1037.5	1961.4
Rumex acetosa	256.6	89.0	674.3	300.0	1220.6	768.4	5883.4	2044.1	225.0	280.7	2175.0	858.0	589.8	342.0	2447.7	946.6
Trifolium repens	40.9	109.7		385.6	704.3	552.1		987.9	108.6	114.0		245.5	279.8	292.2		514.4
Rhinanthus minor		176.7	667.4	946.5		1369.8	12044.2	4204.7		190.7	1886.0	1265.1		441.9	3976.7	2090.7

AREA 3

Holcus lanatus	33.7		110.1	923.11	174.6		717.5	6189.6	31.4		97.0	926.9	170.1		256.8	2508.0
Poa trivialis	4.7	7.5	12.4	3.8	101.7	144.9	239.4	113.9	15.1	24.1	40.0	20.9	101.7	118.1	154.0	45.4
Alopecurus pratensis	16.5	11.6	105.0	155.7	111.3	398.8	644.0	2109.9	26.8	51.1	135.7	882.4	156.6	211.3	289.6	2462.9
Festuca rubra	3.5	2.1	5.2	5.3	99.7	75.0	253.2	253.5	9.8	8.1	20.8	24.3	72.5	42.6	48.8	48.7
Bromus mollis		48.2	30.8	15.9		195.2	221.8	67.2		112.2	159.1	29.9		204.3	183.3	64.3
Helictotrichon pubescens	10.1		27.5	7.5	430.9		992.8	414.7	51.2		120.2	43.3	244.2		571.4	123.1
Ranunculus bulbosus	1189.4	2137.9	345.5	256.1	3377.3	4704.5	1304.5	498.5	739.4	3313.6	310.6	284.8	2897.0	6131.8	2777.3	898.5
Rhinanthus minor		93.8	309.4	205.0		1454.7	2834.3	5048.4		351.6	1103.1	1071.9		1939.1	4917.2	1798.4
Cerastium holosteoides		24.7	114.6	30.3		228.1	906.0	538.6		47.6	196.6	83.1		219.9	858.4	194.4

AREA 4

Molinia caerulea	9.5	10.2		10.6	177.9	161.3		327.6	15.77	23.4		95.1	123.4	110.4		60.7
Eriophorum angustifolium	95.6	79.9		171.5	1582.8	1466.3		858.2	234.9	289.2		300.5	591.4	755.3		361.9
Carex lanicea	40.6	39.4		46.3	760.0	864.4		1440.0	154.9	163.4		425.1	478.6	591.4		545.7

Anthoxanthum odoratum

11.4 22.8 59.7 18.0 146.0 260.1 341.8 294.0 28.5 54.2 98.5 58.0 114.4 135.4 242.1 98.0

Holcus lanatus 30.8 61.2 26.8 151.2 151.9 195.4 203.4 42.8 68.6 44.7 166.1 200.6 79.3

Poa trivialis 13.1 5.2 2.9 103.8 103.8 164.0 59.0 31.9 16.1 13.7 55.9 42.0 21.1

Festuca rubra 1.7 5.5 4.5 3.8 46.2 95.3 72.4 84.4 144.0 7.4 17.9 11.5 19.7 26.4 6.9 55.3 31.4 99.2 43.4

Cynosurus cristatus 19.1 58.6 83.1 45.7 99.0 277.1 404.6 253.2 16.0 44.8 58.9 57.6 23.4 104.6 196.6 88.5

Ranunculus bulbosus 28.0 25.9 75.6 243.4 416.9 491.0 753.9 136.1 31.3 47.9 139.5 422.0 78.3 83.7 372.0 831.0 1096.7 254.2

Rumex acetosa 59.7 35.1 129.9 462.3 163.6 776.6 237.7 100.0 510.4

Trifolium repens 73.4 153.7 110.2 317.5 558.8 349.2 205.1 344.6 163.8

Plantago lanceolata 74.7 105.8 387.8 379.5 470.5 192.8 403.4 8382.5 362.2 470.5 332.6 204.2 702.2 408.2 470.5 161.5 393.9 1257.6 638.2 846.9

AREA 7 Anthoxanthum odoratum 6.0 8.2 12.6 167.8 172.9 249.2 28.4 36.6 26.8 56.8 70.7 89.0

Holcus lanatus 22.1 16.2 9.4 629.4 207.2 152.2 88.5 35.5 14.8 162.5 32.5 68.8

Festuca rubra 3.3 2.4 5.4 123.5 56.3 53.2 19.7 9.7 33.8 27.4 8.3 81.1

Nardus stricta 9.4 8.6 7.6 6.7 94.9 80.4 285.0 155.3 105.4 30.4 17.7 31.8 28.9 21.4 133.2 25.9 38.8 31.1 39.0

Carex pulicaris 11.8 5.5 4.9 145.2 157.9 136.6 36.0 23.9 21.7 581.9 205.1 119.4 260.3 645.6

Carex panicea 13.3 38.4 19.4 29.1 67.9 515.2 717.7 853.2 1042.6 968.4 130.8 153.6 127.0 172.2 217.7 581.9 205.1 119.4 260.3 645.6

Juncus squarrosus 1.8 271.1 80.5 137.1 128.9 676.8 636.8 1052.1 718.7 1127.8 332.6 170.5 162.6 99.4 120.4 177.6 89.0 279.3 54.7 321.8

Ranunculus bulbosus .4 180.4 173.2 534.8 1162.5 1559.8 35217 297.3 284.9 189.9 460.7 413.4 819.6 2152.5

Trifolium repens 42.5 50.3 85.3 60.1 169.5 445.0 347.5 584.3 94.7 284.9 189.9 460.7 122.0 498.4 183.3 811.3

AREA 8 Festuca ovina 1.6 3.8 26.5 41.9 26.3 187.6 112.4 89.6 7.7 3.0 6.7 13.8 9.3 8.5 55.0 35.0 25.1

Nardus stricta 2.2 9.4 27.9 113.0 113.3 63.2 38.7 63.6 13.4 6.6 21.3 13.8 9.3 8.5 55.0 35.0 25.1

Agrostis canina .2 5.6 2.4 11.5 56.3 42.4 63.2 38.7 63.6 13.4 6.6 21.3 13.8 9.3 8.5 55.0 35.0 25.1

Carex panicea .7 22.3 21.5 36.8 517.4 499.2 341.3 535.6 553.4 86.2 81.8 71.7 132.8 184.6 220.0 259.5 256.3 116.2 553.4

AREA 5

<i>Anthoxanthum odoratum</i>	24.5	7.6	21.6	11.7	5.8	24.5	7.6	21.6	11.7	5.8	24.5	7.6	21.6	11.7	5.8
<i>Holcus lanatus</i>		11.4	22.8	59.7	18.0		146.0	260.1	341.8	294.0		28.5	54.2	98.5	58.0
<i>Poa trivialis</i>			30.8	61.2	26.8		151.2	151.9	195.4	203.4			42.8	68.6	44.7
<i>Festuca rubra</i>	1.7	5.5	2.5	4.5	3.8	46.2	95.3	72.4	84.4	144.0	7.4	17.9	11.5	19.7	26.4
<i>Cynosurus cristatus</i>		19.1	58.6	83.1	45.7		99.0	277.1	404.6	253.2		16.0	44.8	58.9	57.6
<i>Ranunculus bulbosus</i>	28.0	25.9	75.6	243.4	170.8	290.1	416.9	491.0	753.9	136.1	31.3	47.9	139.5	422.0	78.3
<i>Rumex acetosa</i>			59.7	35.1	129.9		462.3	163.6	776.6				237.7	100.0	510.4
<i>Trifolium repens</i>			73.4	153.7	110.2		317.5	558.8	349.2				205.1	344.6	163.8
<i>Plantago lanceolata</i>	74.7	105.8	387.8	379.5	470.5	192.8	403.4	8382.5	362.2	470.5	332.6	204.2	702.2	408.2	470.5

AREA 7

<i>Anthoxanthum odoratum</i>			6.0	8.2	12.6		167.8	172.9	249.2				28.4	36.6	26.8
<i>Holcus lanatus</i>			22.1	16.2	9.4		629.4	207.2	152.2				86.5	36.5	14.8
<i>Festuca rubra</i>			3.3	2.4	5.4		123.5	56.3	53.2				19.7	9.7	33.8
<i>Nardus stricta</i>	9.4	8.6	5.8	7.6	6.7	94.9	80.4	285.0	156.3	105.4	30.4	17.7	31.8	28.9	21.4
<i>Carex pulicaris</i>		11.8	5.5	4.9			145.2	157.9	136.6			52.7	36.0	23.9	
<i>Carex panicea</i>	33.3	38.4	19.4	29.1	67.9	515.2	717.7	853.2	1042.6	968.4	130.8	153.6	127.0	172.2	217.7
<i>Juncus squarrosus</i>	489.8	271.1	80.5	137.1	128.9	676.8	636.8	1052.1	718.7	1127.8	332.6	170.5	162.6	99.4	120.4
<i>Ranunculus bulbosus</i>	438.4		180.4		173.2	534.8		1162.5		1559.8	352.7		297.3		638.4
<i>Trifolium repens</i>		42.5	50.3	85.3	60.1		169.5	445.0	347.5	584.3		94.7	284.9	189.9	460.7

AREA 8

<i>Festuca ovina</i>	5.3	1.6		3.8		41.9	26.3	21.2			7.7	3.0		6.7	4.0
<i>Nardus stricta</i>	8.3	12.2	9.4	27.9	26.5	113.0	113.3	187.6	112.4	89.6	15.6	17.6	23.0	21.3	13.8
<i>Agrostis canina</i>	7.7	6.2	5.6	2.4	11.5	56.3	42.4	63.2	38.7	63.6	13.4	6.6	13.2	6.96	17.8
<i>Carex panicea</i>	52.6	15.0	22.3	21.5	36.8	517.4	499.2	341.3	535.6	553.4	86.2	81.8	71.7	132.8	184.6

DATE	SODIUM					POTASSIUM					MAGNESIUM					CALCIUM					
	24.5	7.6	21.6	11.7	5.8	24.5	7.6	21.6	11.7	5.8	24.5	7.6	21.6	11.7	5.8	24.5	7.6	21.6	11.7	5.8	
AREA 2																					
Holcus lanatus	8.3	47.3	138.8	255.5	228.8	296.3	184.6	1523.1	19.6	34.0	96.4	147.3	34.6	57.7	229.1	184.8					
Poa trivialis	8.4	21.3	33.7	17.1	357.3	307.9	540.6	247.8	29.5	33.7	67.0	43.9	52.8	57.6	181.9	57.1					
Alopecurus pratensis	25.3	27.3	51.1	61.4	244.7	459.7	843.5	912.4	18.9	29.2	63.9	118.6	29.7	43.8	99.4	136.1					
Agrostis tenuis	14.3	79.3	41.5	44.0	126.9	294.5	320.3	370.8	22.3	45.0	49.0	50.3	30.4	67.4	74.1	52.5					
Festuca rubra	6.9		7.9	4.7	223.7		242.9	143.9	14.3		20.2	14.9	27.2		40.5	21.1					
Bromus mollis		31.4	46.6	27.5		151.7	318.0	98.9		29.3	51.3	25.7		34.7	71.6	31.2					
Ranunculus bulbosus	4.9	51.3	55.1	114.6	73.6	149.1	129.7	209.5	12.9	46.4	45.6	85.1	19.0	48.1	91.3	172.6					
Rumex acetosa	34.9	12.1	91.7	40.8	166.0	104.5	800.0	278.0	30.6	24.7	191.4	75.5	51.9	30.1	215.4	83.3					
Trifolium repens	10.5	28.2		99.1	181.0	141.9		253.9	27.9	29.3		63.1	71.9	75.1	132.2						
Rhinanthus minor		7.6	28.7	40.7		58.9	517.9	180.8		8.2	81.1	54.4		19.0	171.6	89.9					
other species	33.7	67.9	119.5	131.8	418.0	472.5	1209.8	460.5	83.9	83.2	256.1	112.0	121.6	147.7	583.7	170.1					
Debris	51.4	63.5	72.3	101.1	380.7	432.6	403.5	361.0	165.4	148.7	129.9	179.9	295.4	369.2	515.1	396.1					
TOTAL	198	437	686	938	2401	2969	5511	5040	425	512	1052	971	734	950	2264	1527					
AREA 3																					
Holcus lanatus	11.4		37.2	312.0	59.0		242.5	2092.1	10.6		32.8	313.3	57.5		86.8	847.7					
Poa trivialis	8.1	13.1	21.6	6.6	176.5	251.5	415.6	232.4	26.3	41.9	69.4	36.2	176.5	205.0	267.3	78.9					
Alopecurus pratensis	13.3	9.3	84.5	125.3	89.6	321.0	518.4	1698.5	21.6	41.1	109.2	710.3	126.1	170.1	233.1	1982.6					
Festuca rubra	21.5	13.2	32.1	32.6	614.3	462.0	1560.8	1562.7	60.4	49.8	128.2	149.8	446.7	262.3	300.8	300.3					
Bromus mollis		59.9	38.2	19.7		242.4	275.5	83.5		139.4	197.6	37.1		253.8	227.6	72.8					
Helictotrichon pubescens	3.5		9.5	2.6	149.1		343.5	143.5	17.7		41.6	15.0	84.5		197.7	42.6					
Ranunculus bulbosus	78.5	141.1	22.8	16.9	222.9	310.5	86.1	32.9	48.8	218.7	20.5	18.8	191.2	404.7	183.3	59.3					
Rhinanthus minor		6.0	19.8	13.1		93.1	181.4	323.1		22.5	70.6	68.6		124.1	314.7	115.1					
Cerastium holostæodes		6.6	30.6	8.1		60.9	241.9	143.8		12.8	52.5	22.2		58.7	229.2	51.9					
other species	72.2	49.9	83.4	21.6	425.5	158.9	914.5	218.9	107.0	54.8	247.8	61.9	924.3	197.3	1307.3	232.0					
Debris	82.1	164.7	168.6	32.1	325.6	692.0	417.9	286.2	195.0	266.6	909.2	119.8	1476.8	1011.5	2162.7	663.8					
TOTAL	291	464	548	591	2062	2592	5198	6818	488	848	1879	1553	3483	2687	5510	4434					

DATE	SODIUM					POTASSIUM					MAGNESIUM					CALCIUM					
	24.5	7.6	21.6	11.7	5.8	24.5	7.6	21.6	11.7	5.8	24.5	7.6	21.6	11.7	5.8	24.5	7.6	21.6	11.7	5.8	
AREA 4																					
<i>Molinia caerulea</i>	17.2	18.5		19.3		322.8	292.6		594.3		28.6	42.4		172.5		223.8	200.3		110.2		
<i>Eriophorum angustifolium</i>	38.9	32.5		69.8		644.2	596.8		349.3		95.6	117.7		122.3		240.7	307.4		147.3		
<i>Carex panicea</i>	14.2	13.8		16.2		266.0	302.6		504.0		54.2	57.2		148.8		167.5	207.0		191.0		
other species	15.2	8.7		4.6		87.5	102.8		110.1		41.4	28.4		49.7		128.5	98.3		34.0		
Debris	70.3	59.8		83.4		214.3	127.4		195.6		187.8	261.0		333.7		1070.1	1106.7		750.9		
TOTAL	161	133		203		1547	1422		1830		419	507		897		1925	1920		1426		

DATE	SODIUM					POTASSIUM					MAGNESIUM					CALCIUM					
	24.5	7.6	21.6	11.7	5.8	24.5	7.6	21.6	11.7	5.8	24.5	7.6	21.6	11.7	5.8	24.5	7.6	21.6	11.7	5.8	
AREA 5																					
<i>Anthoxanthum odoratum</i>		4.6	9.2	24.1	7.3		59.0		105.1	138.1	119.0		11.5	21.9	39.8	23.5		46.2	54.7	97.8	39.6
<i>Holcus lanatus</i>			25.4	50.5	22.1				125.3	161.2	167.8			35.3	56.6	36.9			137.0	165.5	65.4
<i>Poa trivialis</i>			11.2	4.4	2.5				88.5	54.6	50.3			27.2	13.7	11.7			47.7	35.8	18.0
<i>Festuca rubra</i>	4.6	16.1	7.4	13.3	11.1	135.4	279.2	212.2	247.5	422.1	21.6	52.4	33.6	57.6	77.4	20.1	162.1	92.0	290.8	127.2	
<i>Cynosurus cristatus</i>		17.7	54.2	76.9	42.3		91.8	256.3	374.3	243.3		14.8	41.4	54.5	53.3		21.6	96.8	181.9	81.9	
<i>Ranunculus bulbosus</i>	9.3	8.6	25.1	80.8	56.7	96.3	138.4	163.0	250.3	45.3	10.4	15.9	46.3	140.1	26.0	27.8	123.5	275.9	364.1	84.4	
<i>Rumex acetosa</i>			4.6	2.7	10.0			35.6	12.6	59.8			18.3	7.7	39.3			43.4	19.0	50.3	
<i>Trifolium repens</i>			13.0	27.2	19.5			56.2	98.9	61.8			36.3	61.0	29.0			173.4	166.0	54.9	
<i>Plantago lanceolata</i>	68.7	96.3	356.0	349.5	433.0	177.5	371.0	352.0	333.0	433.0	305.0	193.0	746.0	386.0	433.0	148.5	362.0	1159.0	587.0	777.0	
other species	84.4	59.7	25.4	178.7	178.7	1767.2	1477.9	644.9	1127.6	1950.4	461.3	390.8	368.6	486.9	1105.4	1000.8	1109.9	855.0	1067.0	1454.9	
Bryophytes	11.4	88.1	7.2	5.3	4.4	71.9	83.7	49.9	33.1	37.3	61.8	59.2	18.2	19.2	22.8	91.1	202.4	108.9	89.1	49.6	
Debris	27.0	66.7	123.1	93.1	72.5	331.3	374.0	307.8	232.0	305.6	169.4	239.8	299.3	268.9	463.2	468.4	419.7	1619.8	1132.8	1075.4	
TOTAL	206	356	662	987	860	2578	2875	2397	3063	3887	1030	978	1693	1511	2321	1730	2448	3205	4195	3268	

DATE	SODIUM					POTASSIUM					MAGNESIUM					CALCIUM					
	24.5	7.6	21.6	11.7	5.8	24.5	7.6	21.6	11.7	5.8	24.5	7.6	21.6	11.7	5.8	24.5	7.6	21.6	11.7	5.8	
AREA 7																					
<i>Anthoxanthum odoratum</i>			1.9	2.6	4.0				53.2	54.8	79.0		9.0	11.6	8.5			18.0	22.4	28.2	
<i>Holcus lanatus</i>			17.2	12.6	7.3				490.3	161.4	118.6		67.4	28.4	11.5			126.6	25.3	53.6	
<i>Festuca rubra</i>			3.3	2.4	5.4				123.5	56.3	153.2		19.7	9.7	33.8			27.4	8.3	81.1	
<i>Nardus stricta</i>	6.3	5.8	3.9	5.1	4.5	63.8	54.0	191.5	105.0	70.8	20.4	11.9	21.4	19.4	14.4	89.5	17.4	26.1	20.9	26.2	
<i>Carex pulicaris</i>		4.1	1.9	1.7					50.4	47.4		18.3	12.5	8.3			17.0	22.0	15.4		
<i>Carex panicea</i>	7.9	9.1	4.6	6.9	16.1	122.1	170.1	202.2	247.1	229.5	30.0	36.4	30.1	40.8	51.6	137.9	48.6	28.3	61.7	153.0	
<i>Juncus squarrosus</i>	172.9	95.7	28.4	48.4	45.5	238.9	224.8	371.4	253.7	398.1	117.4	60.2	57.4	35.1	42.5	62.7	31.4	98.6	19.3	113.6	

Table 5.3 contd.

DATE	SODIUM					POTASSIUM					MAGNESIUM					CALCIUM					
	AREA	7 contd.	7.6	21.6	11.7	5.8	24.5	7.6	21.6	11.7	5.8	24.5	7.6	21.6	11.7	5.8	24.5	7.6	21.6	11.7	5.8
	Ranunculus bulbosus	24.5	7.6	21.6	11.7	5.8	24.5	7.6	21.6	11.7	5.8	24.5	7.6	21.6	11.7	5.8	24.5	7.6	21.6	11.7	5.8
	Trifolium repens	49.1		20.2	27.3	19.4	59.9		130.2	174.7	39.5		33.3		71.5	46.3		91.8		281.4	
	other species		13.5	16.0	19.1	19.1		53.9	141.5	185.8		30.1	90.6	60.4	146.5		38.8	158.5	58.3	258.0	
	Rhytidadelphus squarrosus	74.7	107.5	48.4	67.0	75.2	580.2	541.6	523.9	807.4	146.9	155.9	129.1	55.9	216.4	264.8	234.2	224.1	75.1	494.6	
	Acrocladium cuspidatum			7.5	7.0	5.9			62.8	63.7			32.5	23.6	34.0			97.6	27.0	123.2	
	other mosses	37.7	45.3	43.2	4.1	38.8	255.6	241.2	377.6	399.6	191.8	169.7	183.0	19.4	272.3	859.8	290.1	611.2	37.9	1258.8	
	Debris	203.5	7.5	14.4	51.4	10.2	223.6	47.4	132.3	65.2	169.6	26.6	60.1	194.2	40.6	244.7	65.3	103.3	393.0	168.7	
	TOTAL	298.0	80.3	74.7	42.4	47.6	568.1	225.6	503.8	200.0	374.6	488.1	254.9	340.3	143.0	153.5	908.1	393.8	327.1	426.8	771.6
	AREA 8	850	369	286	279	318	2112	1609	3359	1944	3120	1205	764	1086	649	1097	2614	1137	1961	1191	3812
	Pestuca ovina	4.3	1.3		3.1		33.8	21.2		17.1	6.2	22.4		5.4		53.5	3.2		10.6		
	Nardus stricta	22.7	33.4	25.7	76.1	72.3	308.8	309.5	512.5	307.1	220.2	42.5	48.1	62.7	58.3	37.6	25.5	23.2	150.2	95.5	68.7
	Agrostis canina	9.8	7.9	7.1	3.0	14.6	71.7	54.0	80.5	49.3	80.9	17.0	8.4	16.8	8.8	22.1	41.5	9.0	53.7	20.2	67.5
	Carex panicea	13.0	3.7	5.5	5.3	9.1	127.8	123.3	84.3	132.3	136.7	21.3	20.2	17.7	32.8	45.6	56.8	14.7	63.3	28.7	136.7
	other species	0.8	11.2	38.8	27.7	66.4	197.6	209.0	327.9	197.1	242.9	2.3	16.5	74.1	53.5	96.8	65.9	213.2	330.3	115.1	289.8
	Thuidium tamariscinum	15.8	7.6	4.2		13.6	106.4	34.8	20.1		92.4	50.8	15.1			47.5	241.7	24.2	80.1		212.8
	Hypnum cupressiforme	5.0	3.0	3.0		42.2	22.1	20.3	13.5		292.4	9.8	9.1			153.1	75.3	11.2	64.7		730.1
	Rhytidadelphus squarrosus	14.5	3.9	2.6	3.3	9.1	44.0	33.9	19.2	14.9	30.4	14.5	9.1	8.8	8.5	24.3	187.2	22.0	44.5	28.8	116.7
	Hylacomium splendens	6.7	2.4	3.4			5.1	10.9	7.3		4.5	5.5				48.0	8.5	48.4			
	other mosses	5.4	18.1	53.8	86.3	22.5	27.9	155.3	271.7	639.3	136.9	15.6	40.0	193.9	363.1	69.0	43.3	85.6	1462.4	1240.7	315.9
	Debris	98.0	81.7	165.3	54.5	152.0	392.0	645.3	478.7	273.5	381.9	168.0	119.8	433.6	173.6	94.6	994.0	174.7	2344.1	606.5	1401.6
	TOTAL	196	190	309	259	402	1337	1617	1816	1631	1716	369	314	851	704	591	1833	590	4642	2146	3340

DATE	SODIUM			POTASSIUM			MAGNESIUM			CALCIUM						
	24.5	7.6	27.6	11.7	5.8	24.5	7.6	21.6	11.7	5.8	24.5	7.6	21.6	11.7	5.8	
AREA 2																
Holcus lanatus	4.2	10.8	20.1	27.2	9.5	10.0	3.4	30.2	4.6	6.6	9.2	15.1	4.7	6.1	10.1	12.1
Alopecurus pratensis	12.8	6.2	7.4	6.5	10.2	15.5	15.3	18.8	4.4	5.7	6.1	12.2	4.0	4.6	3.9	8.9
Poa trivialis	4.2	4.8	4.9	1.8	14.9	10.4	9.8	14.9	6.9	6.6	6.4	14.5	7.2	6.1	8.0	3.7
Agrostis tenuis	7.2	18.1	6.4	4.7	5.3	9.9	5.8	7.3	5.2	8.8	4.7	5.3	4.1	7.1	3.3	3.4
Festuca rubra	3.5		1.1	0.5	9.3		4.4	2.8	3.4		1.9	1.5	3.7		1.8	1.4
Bromus mollis		7.2	6.8	2.9		5.1	5.8	2.0	5.7	4.9	2.6			3.6	3.2	2.0
Ranunculus bulbosus	2.5	11.7	8.0	12.2	0.3	5.0	2.3	4.2	3.0	9.1	4.3	8.8	2.6	5.1	4.0	11.3
Rumex acetosa	17.6	2.7	13.4	4.3	6.9	3.5	14.5	5.5	7.2	4.8	18.2	7.8	7.1	3.2	9.5	5.5
Trifolium repens	5.3	6.4		10.6	7.5	4.8		5.0	6.6	5.7		6.5	9.8	7.9		8.6
Rhinanthus minor		1.7	4.2	4.3		2.0	9.4	3.6		1.6	7.7	5.6		2.0	7.6	5.9
other species	17.0	15.5	17.4	14.0	17.4	15.9	21.9	9.1	19.7	16.2	24.3	11.5	16.5	15.5	25.8	11.1
Debris	25.9	14.5	10.5	10.7	15.9	14.6	7.3	7.2	38.9	29.0	12.3	18.5	40.2	38.8	22.7	25.9
AREA 3																
Holcus lanatus	3.9		6.8	52.7	2.9		4.7	30.6	2.2		1.7	20.2	1.6		1.6	19.1
Poa trivialis	2.8	2.8	4.7	1.1	8.5	9.7	8.0	3.4	5.4	4.9	3.7	2.3	5.1	7.6	4.8	1.8
Alopecurus pratensis	4.6	2.0	15.4	21.2	4.3	12.4	10.0	24.9	4.4	4.8	5.8	45.7	3.6	6.3	4.2	44.7
Festuca rubra	7.4	2.8	5.8	5.5	29.8	17.8	30.0	22.9	12.4	5.9	6.8	9.6	12.8	9.8	5.4	6.8
Bromus mollis		12.9	7.0	3.3		9.3	5.3	1.2		16.4	10.5	2.4		9.4	4.1	1.8
Helictotrichon pubescens	1.2		1.7	0.4	7.2		6.6	2.1	3.6		2.2	0.1	2.4		3.6	1.0
Ranunculus bulbosus	27.0	30.4	4.2	3.8	10.8	12.0	1.7	0.5	10.0	25.7	1.1	0.1	5.5	15.1	3.3	1.3
Rhinanthus minor		1.3	3.6	2.2	4.0	4.0	3.5	4.7		2.6	3.8	4.4		4.6	5.7	2.6
Cerastium holostedoides		1.4	5.6	1.4		2.3	4.6	2.1		1.5	2.8	1.4		2.2	4.1	1.2
other species	24.8	10.7	15.2	3.6	20.6	6.1	17.6	3.2	21.9	6.5	13.2	4.0	26.5	7.3	23.7	5.2
Debris	28.2	35.4	30.7	5.4	15.8	26.7	8.0	4.2	39.9	31.4	48.4	7.7	42.4	37.6	39.2	15.0
AREA 4																
Molinia caerulea	10.7	13.9		9.5	20.9	20.6		32.5	6.8	8.4		19.2	11.6	10.4		7.7
Eriophorum angustifolium	24.2	24.4		34.4	41.6	42.0		19.1	22.8	23.2		13.6	12.5	16.0		10.3
Carex panicea	8.8	10.4		8.0	17.2	21.3		27.5	12.9	11.3		16.5	8.7	10.8		13.4
other species	9.4	6.5		0.2	5.7	7.2		6.0	10.0	5.6		5.5	6.7	5.1		2.4
Debris	43.7	45.0		41.1	13.8	8.9		10.7	44.8	57.4		37.2	55.5	57.6		52.6

Table 5.4 contd.

	SODIUM				POTASSIUM				MAGNESIUM				CALCIUM			
	24.5	7.6	21.6	11.7	5.8	24.5	7.6	21.6	11.7	5.8	24.5	7.6	21.6	11.7	5.8	
AREA 5																
Anthoxanthum odoratum		1.3	1.4	2.6	0.8		2.0	4.4	4.5	3.1		1.2	1.3	2.6	1.0	
Holcus lanatus			3.8	5.6	2.6			5.2	5.3	4.3			2.1	3.7	1.6	
Poa trivialis			1.7	0.5	0.5			3.7	1.8	1.3			1.6	0.9	0.5	
Festuca rubra	2.2	4.5	1.1	1.5	1.3	5.2	9.7	8.8	8.1	10.8	2.1	5.3	2.0	3.8	3.3	
Cynosurus cristatus		5.0	8.2	8.5	4.9		3.2	10.7	12.2	6.0		1.5	2.4	3.6	2.3	
Ranunculus bulbosus	4.5	2.4	3.8	8.9	6.6	3.7	4.8	6.8	8.2	1.2	1.0	1.6	2.7	9.3	1.1	
Rumex acetosa			0.7	0.3	1.2			1.5	4.1	1.5			0.4	0.5	1.7	
Trifolium repens			2.0	3.0	2.3			2.3	3.2	1.6		2.1	4.0	1.2		
Plantago lanceolata	34.3	27.0	53.7	30.5	50.3	6.9	12.9	14.7	10.9	11.1	29.6	19.7	44.1	25.5	18.6	
other species	42.2	16.8	3.8	19.7	20.7	68.5	51.4	26.9	36.8	50.1	44.8	39.9	21.8	25.9	47.6	
Bryophytes	5.7	24.7	1.1	0.6	0.5	2.8	2.9	2.1	1.1	1.0	6.0	6.0	0.4	1.3	1.0	
Debris	13.0	18.7	18.5	10.3	8.4	12.8	13.0	12.8	7.6	7.9	16.4	24.6	17.7	17.8	20.0	

AREA 7

Anthoxanthum odoratum		0.7	0.9	1.3		1.6	2.8	2.5		0.8	1.8	0.8		0.9	1.9
Holcus lanatus		6.0	4.5	2.3		14.6	8.3	3.8		6.2	4.4	1.0		6.4	2.1
Festuca rubra		1.1	0.9	1.7		3.7	2.9	4.9		1.8	1.5	3.1		1.4	0.7
Nardus stricta	0.7	1.6	1.2	1.8	1.4	3.0	3.4	5.7	5.4	2.3	1.7	1.5	2.0	3.0	3.4
Carex pullicaris		1.1	0.7	0.6		3.1	1.6	2.4		2.3	1.1	1.3		1.5	1.1
Carex panicea	0.9	2.5	1.6	2.5	5.1	5.8	10.5	6.0	12.7	7.3	2.6	4.8	2.8	6.4	4.7
Juncus squarrosus	20.3	25.9	10.0	17.3	14.3	11.3	14.0	11.0	13.1	12.7	9.7	7.9	5.3	5.4	3.9
Ranunculus bulbosus	5.8		7.1		6.1	2.8		3.9		5.6	3.3		3.1		6.5
Trifolium repens		3.6	5.6	10.0	6.1		3.4	4.2	5.7	5.9		3.9	8.3	9.3	13.3
other species	8.8	29.1	16.9	24.0	23.6	27.5	33.7	15.6	9.6	25.9	12.2	20.4	11.9	8.6	19.7
Rhytidiadelphus squarrosus			2.6	2.5	1.8			1.9	2.1	2.0			0.3	3.6	3.1
Acrocladium cuspidatum	4.4	12.3	15.1	1.5	12.2	12.1	15.0	11.2	1.8	12.8	15.9	22.2	16.8	3.0	24.8
other mosses	23.9	2.0	5.1	18.4	3.2	10.6	2.9	3.9	17.8	2.1	14.1	3.5	5.5	29.9	3.7
Debris	35.0	21.8	26.1	15.2	15.0	26.9	14.0	15.0	10.3	12.0	40.5	33.3	31.3	21.8	14.0

Table 5.4 contd.

AREA	SODIUM					POTASSIUM					MAGNESIUM					CALCIUM				
Festuca ovina	24.5	7.6	21.6	11.7	5.8	24.5	7.6	21.6	11.7	5.8	24.5	7.6	21.6	11.7	5.8	24.5	7.6	21.6	11.7	5.8
Nardus stricta	2.2	0.7		1.2		2.5	1.3		1.1		1.7	0.8		0.8		2.9	0.5		0.5	
Agrostis canina	11.6	17.6	8.3	29.4	18.0	23.1	19.1	28.2	18.8	12.8	11.5	15.3	7.4	8.3	6.4	1.4	3.9	3.2	4.4	2.1
Carex panicea	5.0	4.2	2.3	1.2	3.6	5.4	3.3	4.4	3.0	4.7	4.6	3.7	2.0	1.2	3.7	2.3	1.5	1.2	0.9	2.0
other species	6.6	1.9	1.8	2.0	2.3	9.5	7.6	4.6	8.1	8.0	5.8	6.4	2.1	4.6	7.7	3.1	2.5	1.4	1.3	4.1
Thuidium tamariscinum	0.4	5.9	12.6	10.7	16.5	14.8	12.9	18.0	12.1	14.1	0.7	5.2	8.7	7.6	16.4	3.6	36.1	7.1	5.4	8.7
Hypnum cupressiforme	8.1	4.0	1.4		3.4	7.9	2.1	1.1		5.4	13.8	4.8	1.5		8.0	13.1	4.1	1.7		6.4
Rhytidiadelphus squarrosus	2.5	1.6	1.0		10.5	1.6	1.3	0.7		17.0	2.6	2.9	1.0		25.9	4.1	1.9	1.4		21.8
Hylacomium splendens	7.4	2.0	0.8	1.3	2.3	3.3	2.1	1.0	0.9	3.3	8.2	4.6	1.1	1.2	4.1	10.2	3.7	1.0	1.3	2.8
other mosses	3.4	1.3	1.1		0.4	0.8	0.8	0.4		1.2	1.7	0.7			2.6	1.4	1.4	1.0		
Debris	2.8	9.5	17.4	33.3	5.6	2.1	9.6	15.0	39.2	8.0	4.2	12.7	22.7	51.5	11.7	2.4	14.5	31.5	57.8	9.4
	50.0	43.0	53.4	21.0	37.8	29.3	39.9	26.4	16.8	22.2	45.5	38.1	50.9	24.6	16.0	24.2	29.6	50.4	28.3	41.9

KEY FOR FIGURES 5.1-5.23

—△—	Calcium
—□—	Sodium
—○—	Potassium
—■—	Magnesium
————	Dry weight of species (g per m ²)
-----	Mean change in dry weight per plant (mg)

Scale	A	Dry weight per square metre of plant material (g per m ²)
	B	Mineral content in mg per m ²
	C	Mean change in dry weight per plant (mg)
	D	Mineral content in mg per g dry weight of plant material

Figure	5.1	<i>Agrostis canina</i>
	5.2	<i>Agrostis tenuis</i>
	5.3	<i>Alopecurus pratensis</i>
	5.4	<i>Anthoxanthum odoratum</i>
	5.5	<i>Bromus mollis</i>
	5.6	<i>Carex panicea</i>
	5.7	<i>Carex pulicaris</i>
	5.8	<i>Cerastium holostéodes</i>
	5.9	<i>Cynosurus cristatus</i>
	5.10	<i>Eriophorum angustifolium</i>
	5.11	<i>Festuca ovina</i>
	5.12	<i>Festuca rubra</i>
	5.13	<i>Helictotrichon pubescens</i>
	5.14	<i>Holcus lanatus</i>
	5.15	<i>Juncus squarrosus</i>
	5.16	<i>Molinia caerulea</i>
	5.17	<i>Nardus stricta</i>
	5.18	<i>Plantago lanceolata</i>
	5.19	<i>Poa trivialis</i>

5.20	Ranunculus bulbosus
5.21	Rhinanthus minor
5.22	Rumex acetosa
5.23	Trifolium repens

FIGURE 5.1

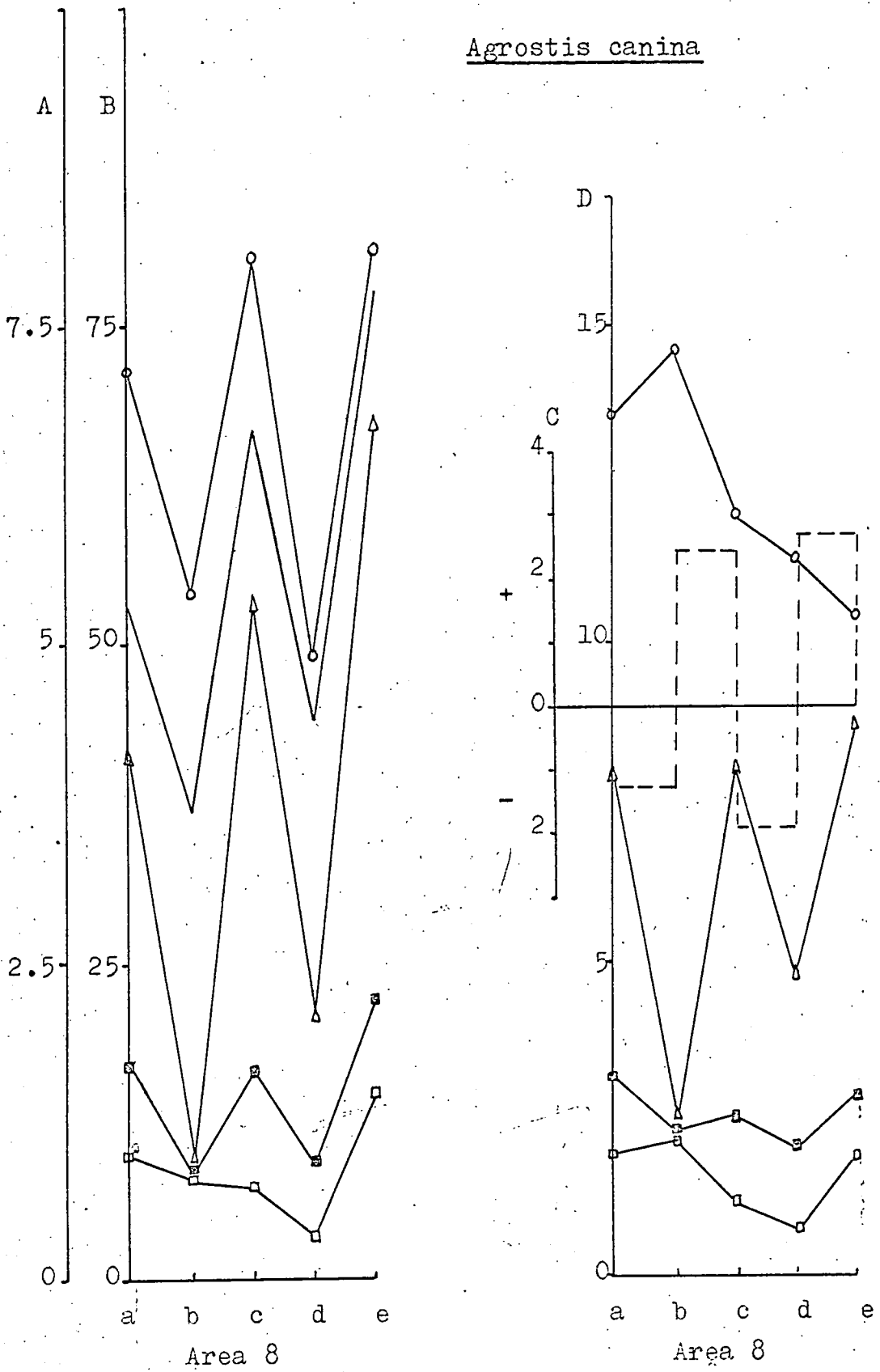

FIGURE 5.2

Agrostis tenuis

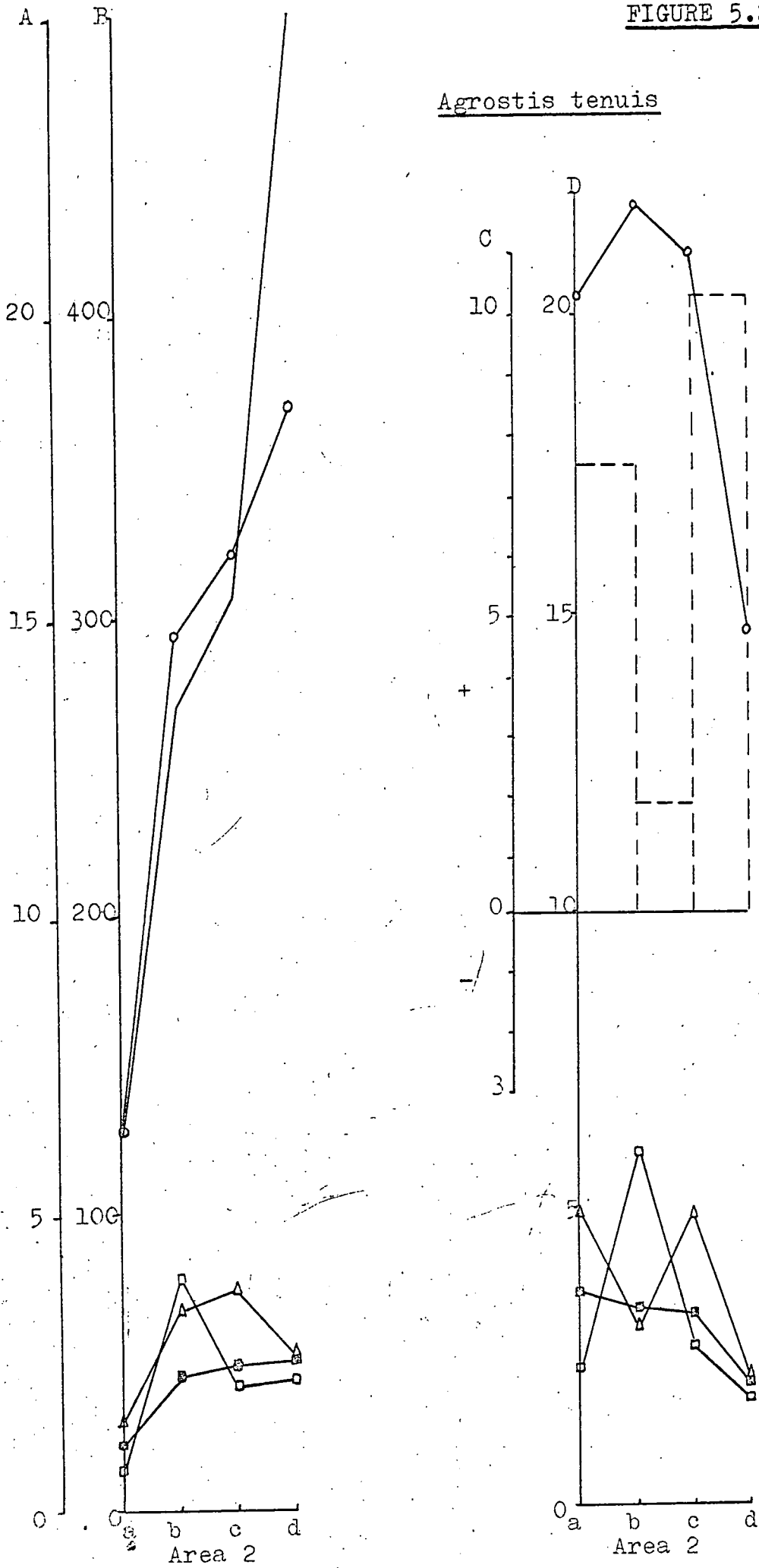
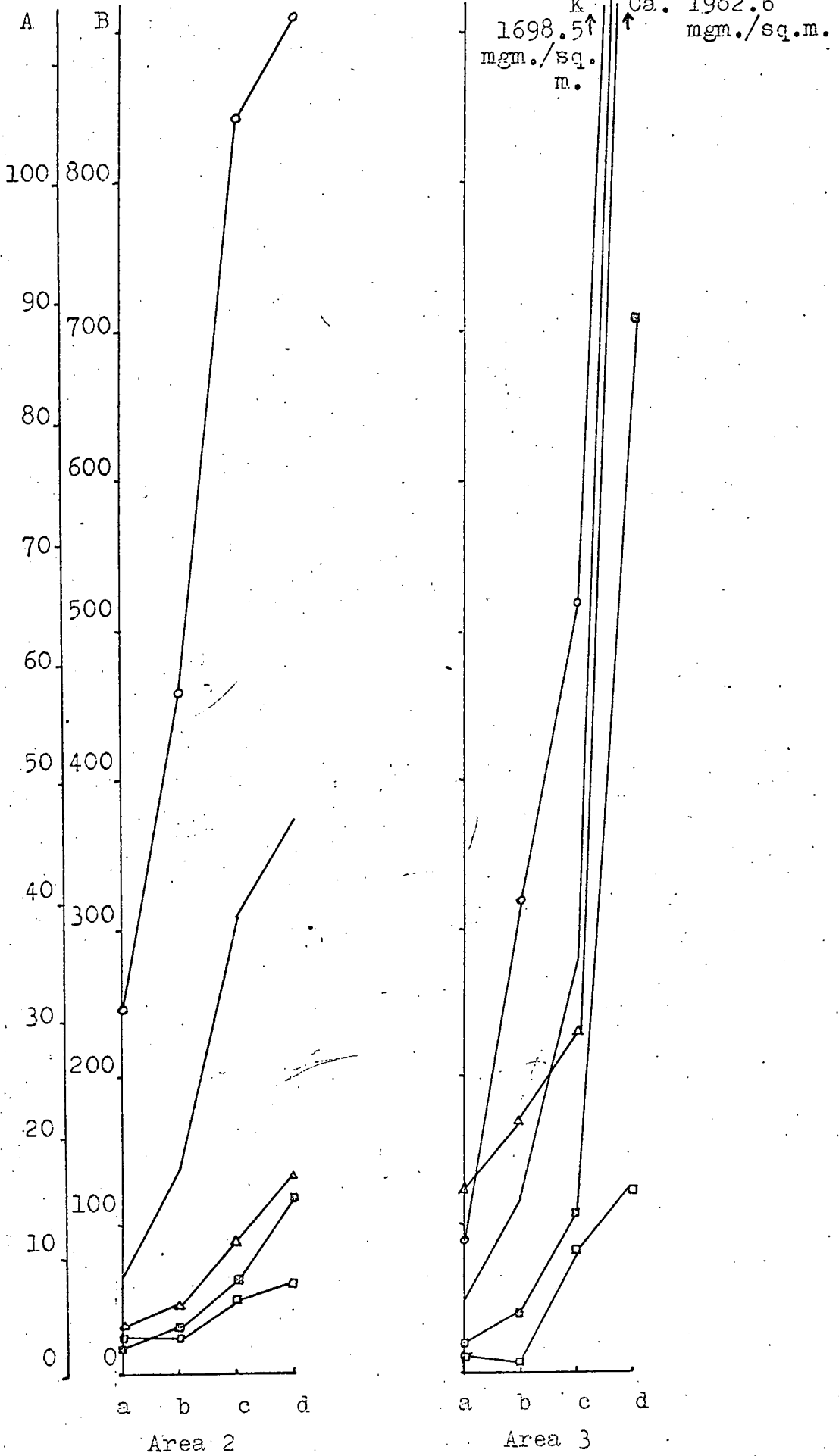
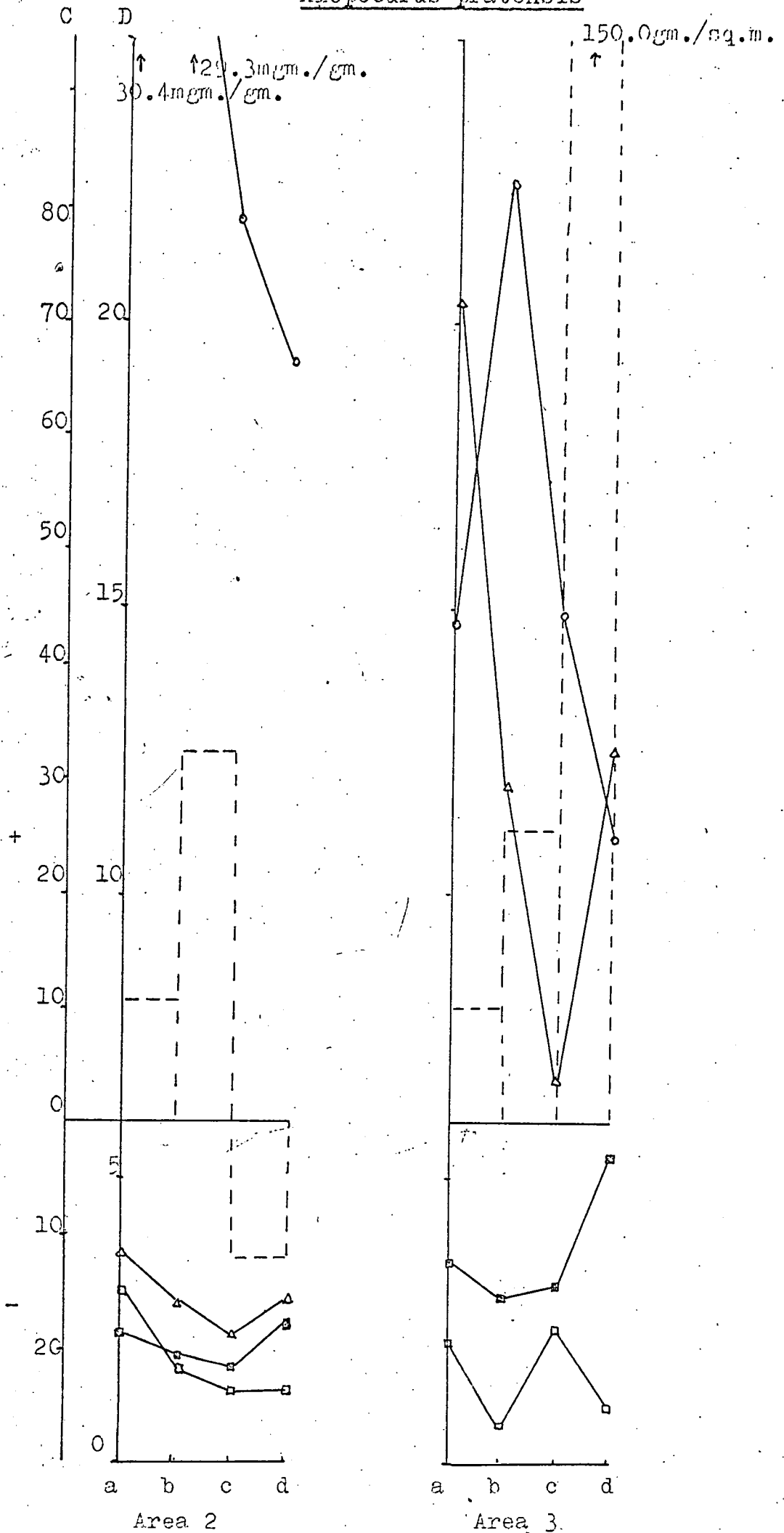

FIGURE 5.3

Alopecurus pratensis



Alopecurus pratensis



Anthoxanthum odoratum

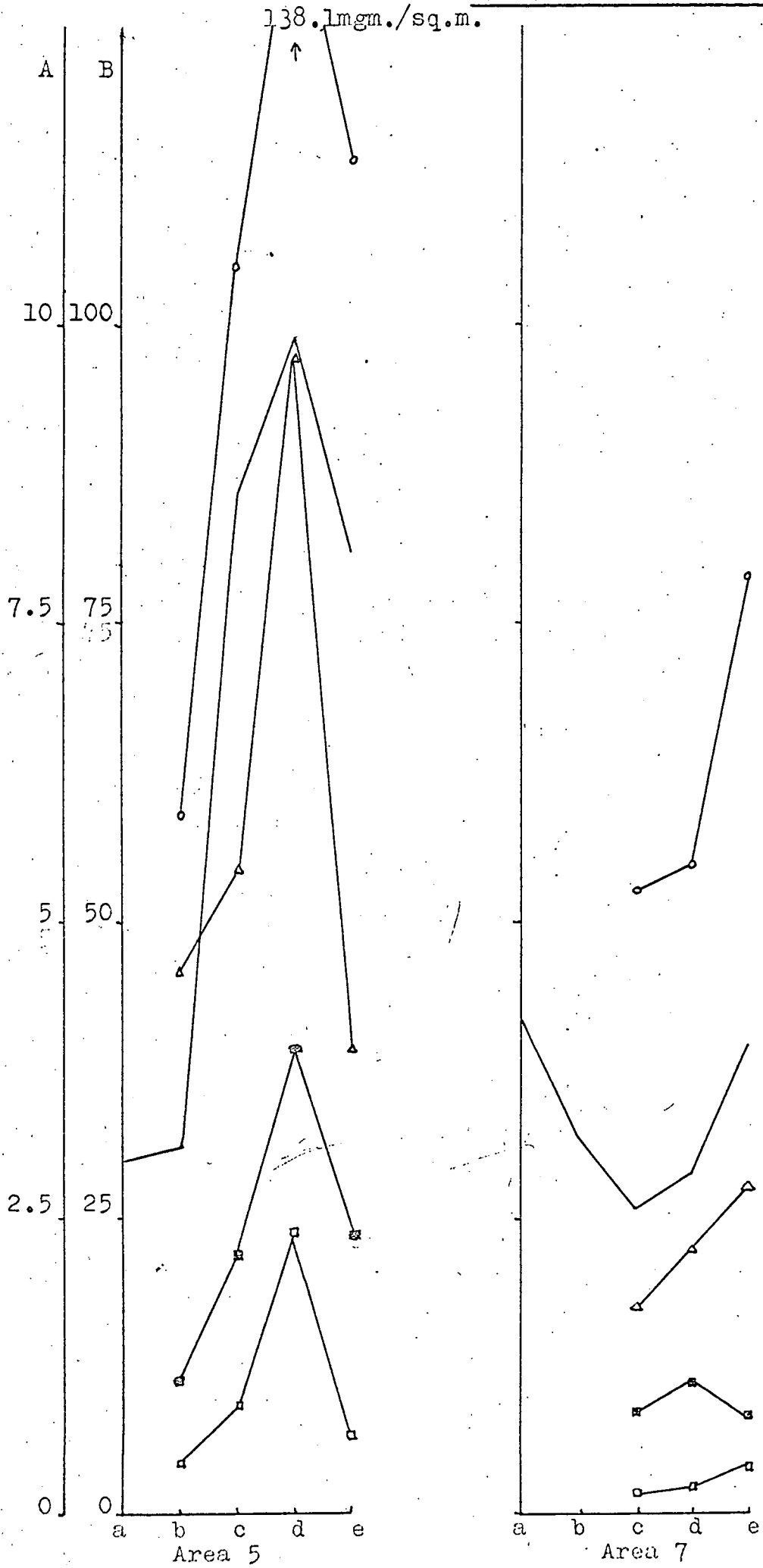

Anthoxanthum odoratum

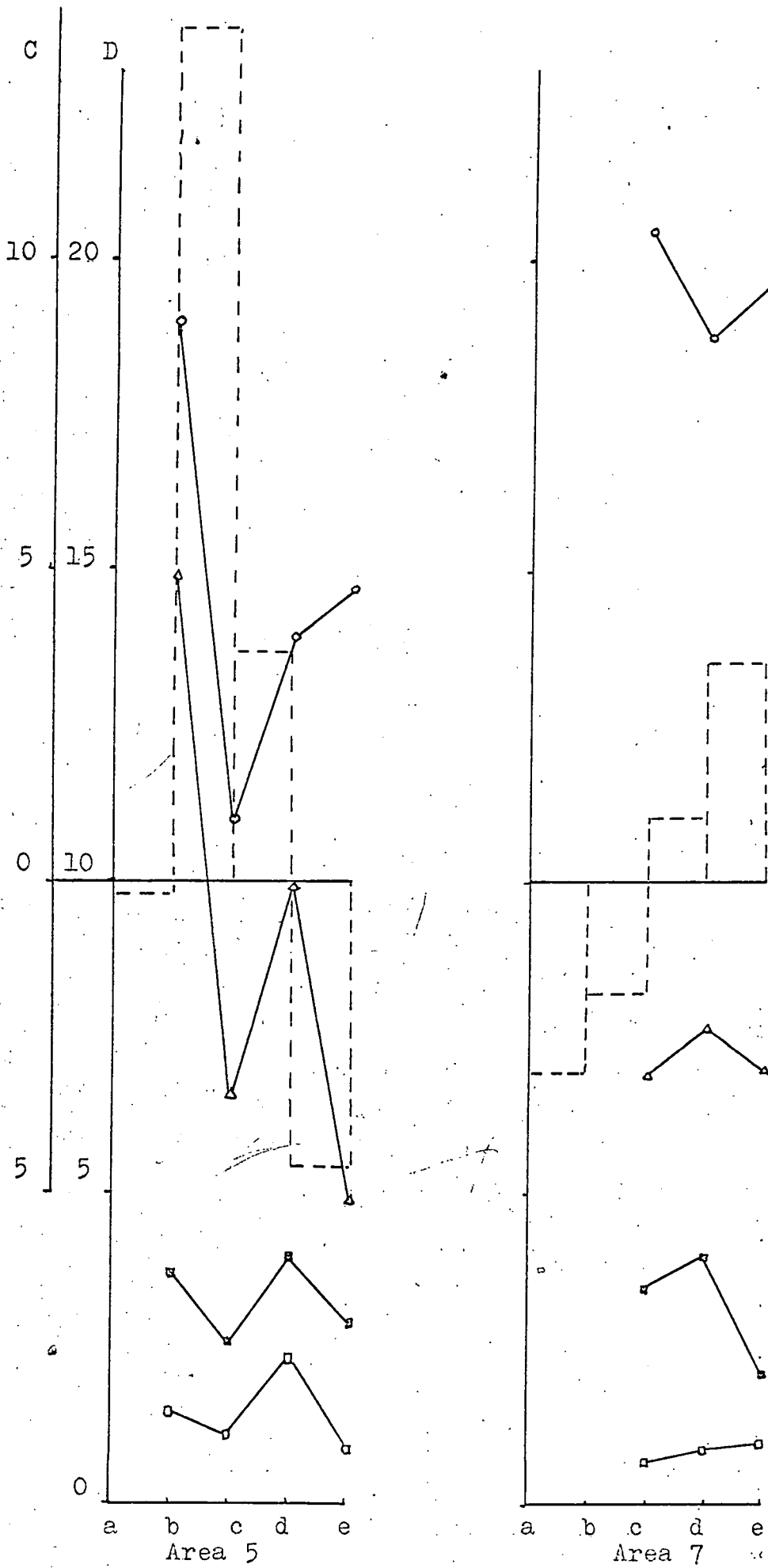

Bromus mollis

FIGURE 5.5

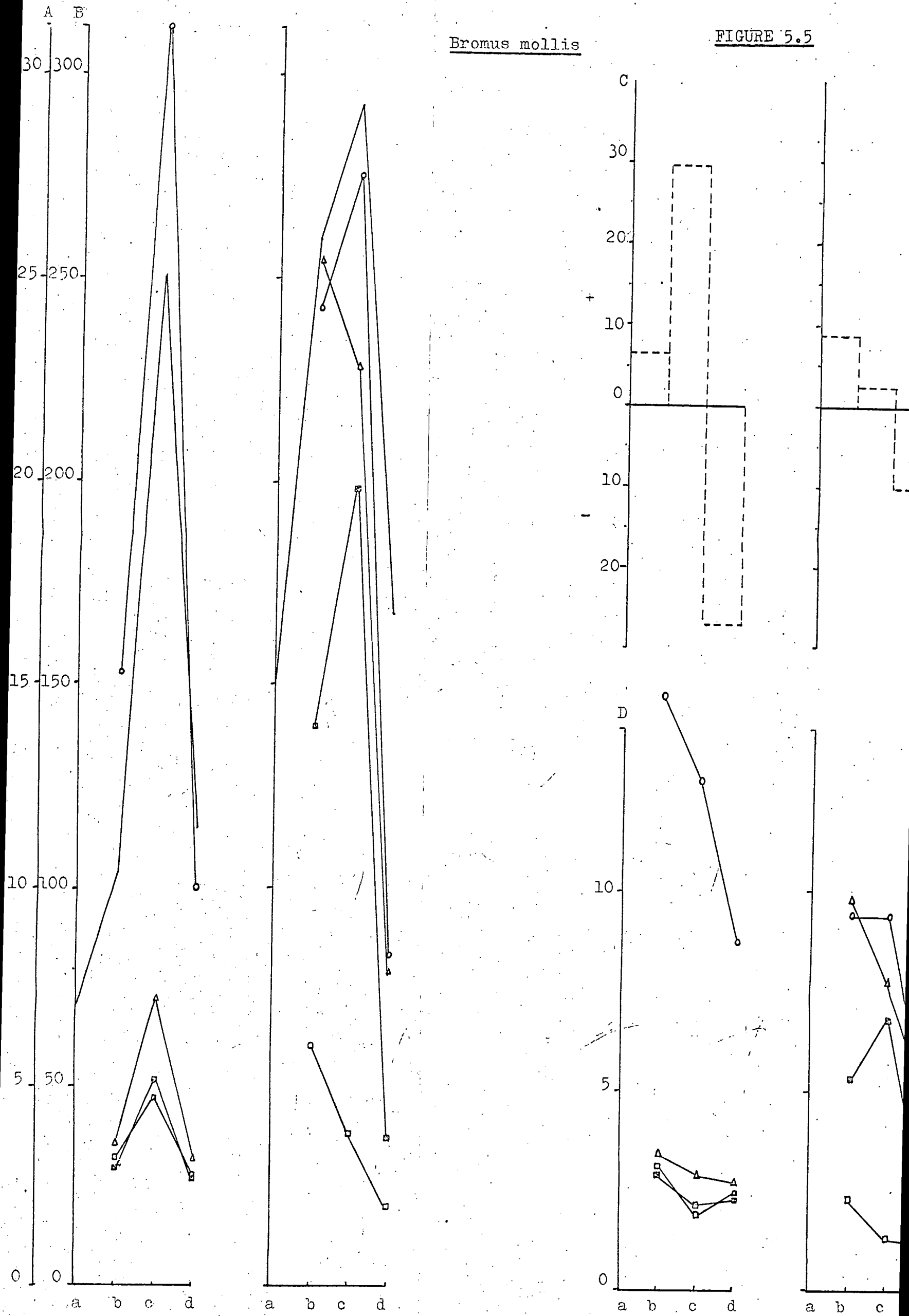

FIGURE 5.6

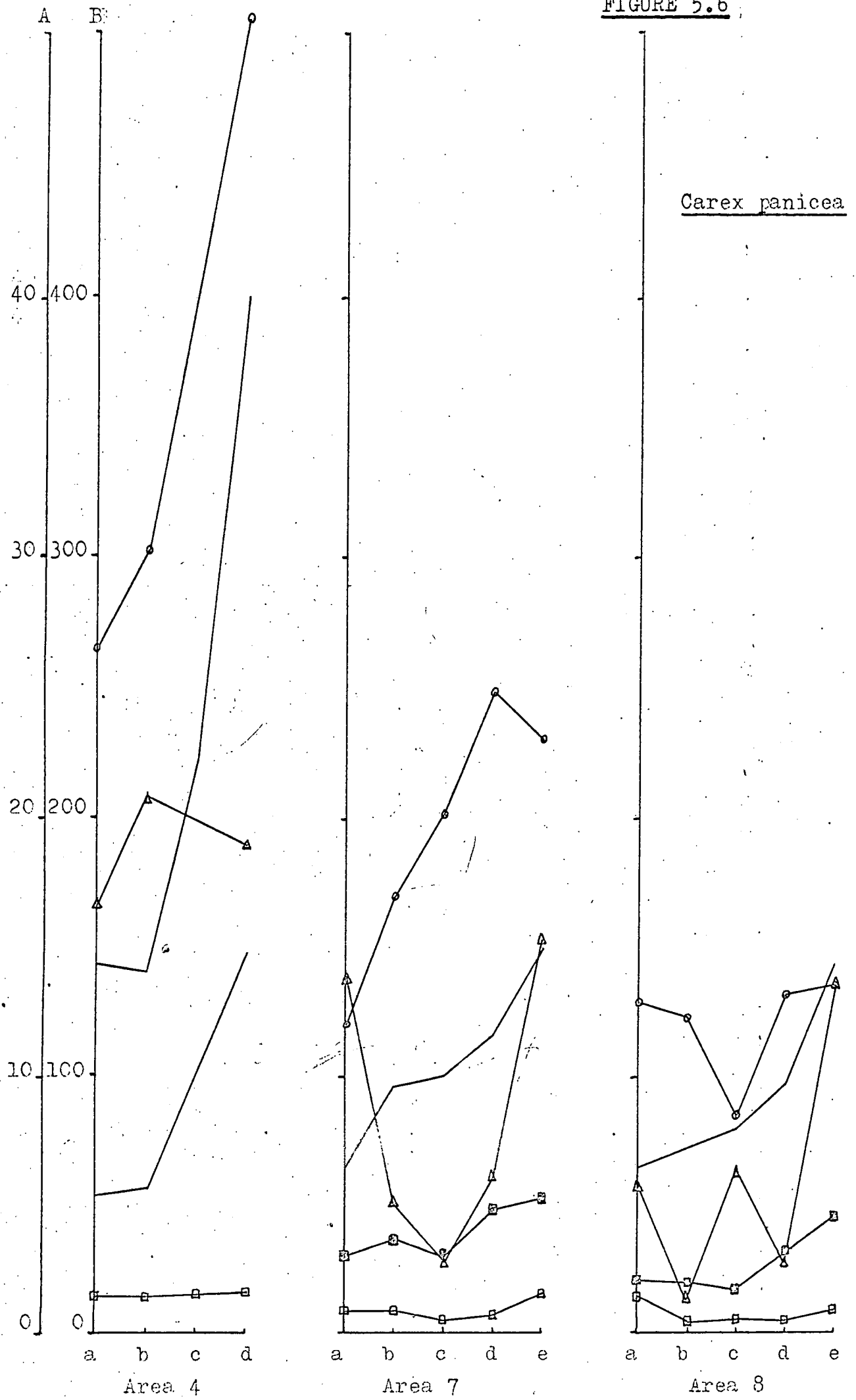

FIGURE 5.6 contd.

Carex panicea

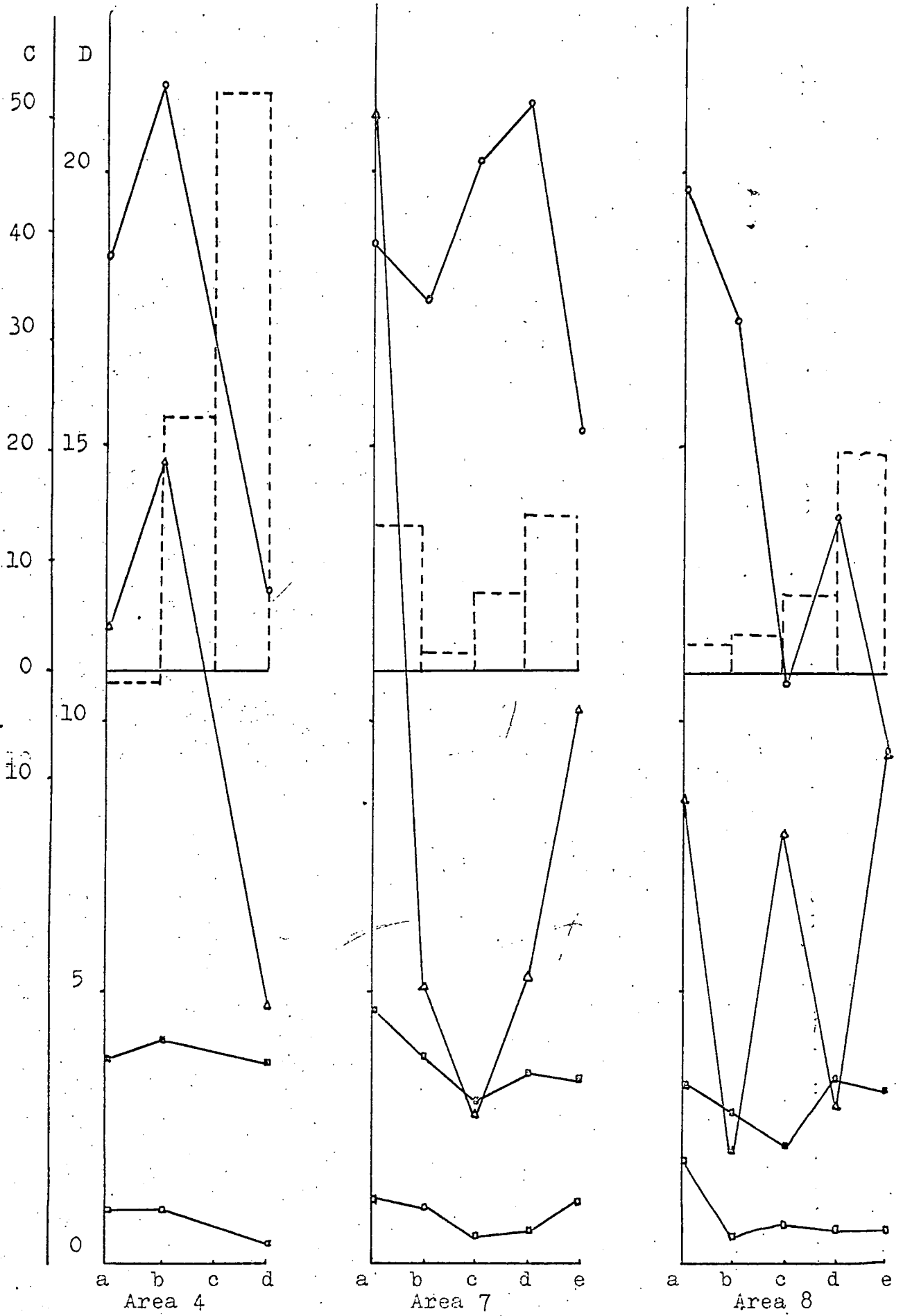
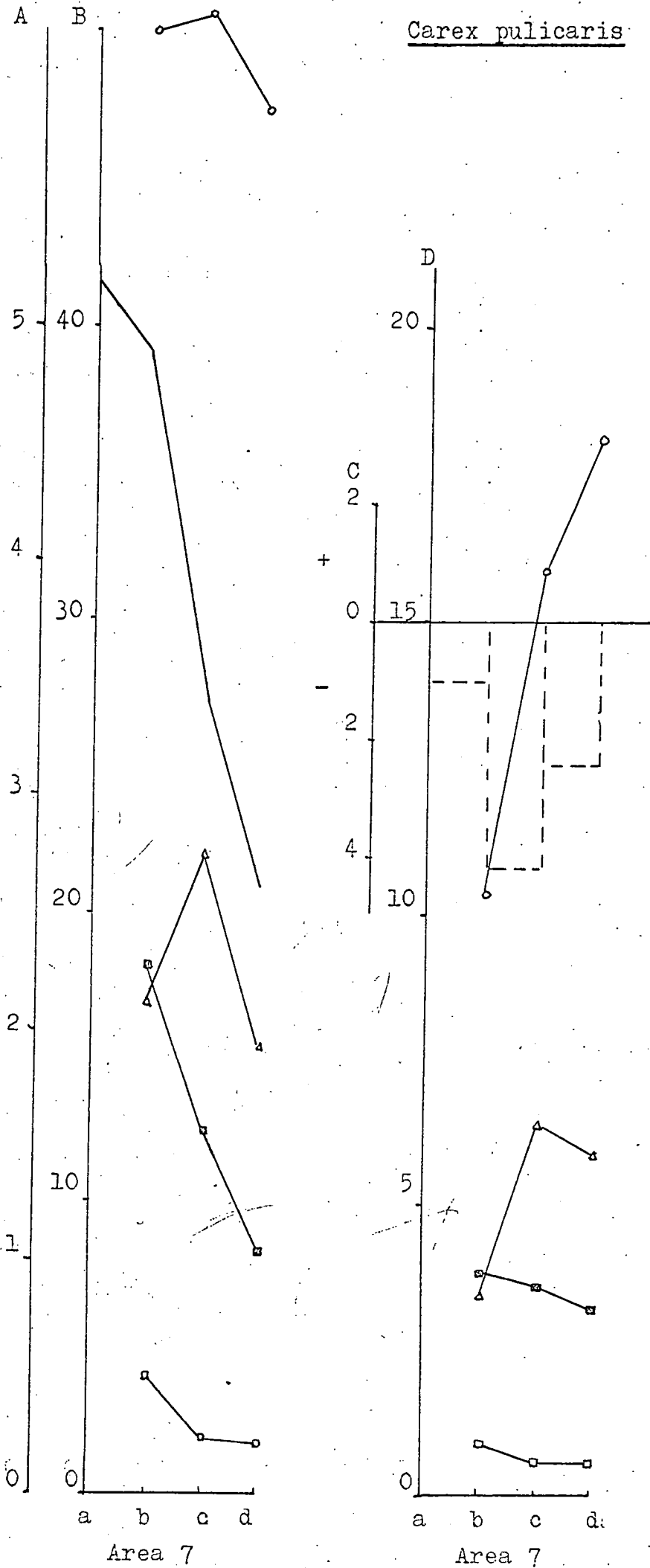

FIGURE 5.7

Carex pullicaris



Cerastium holostoides

FIGURE 5.8

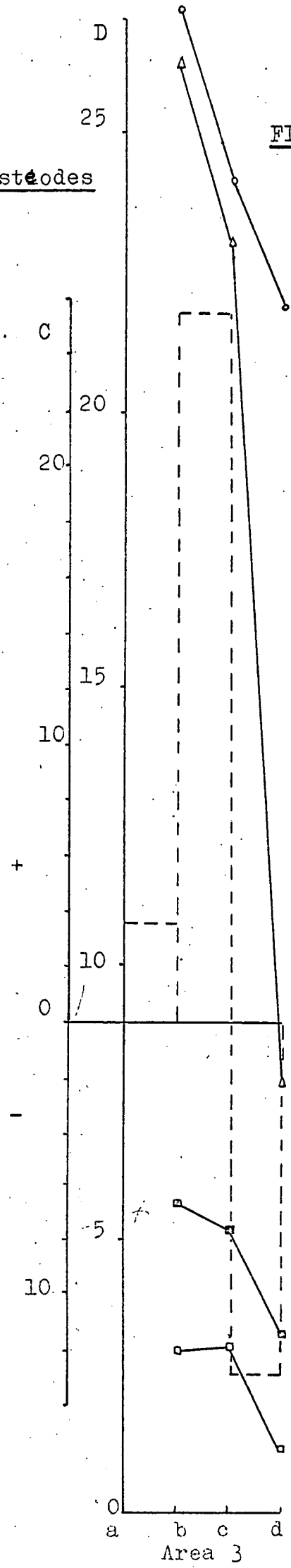
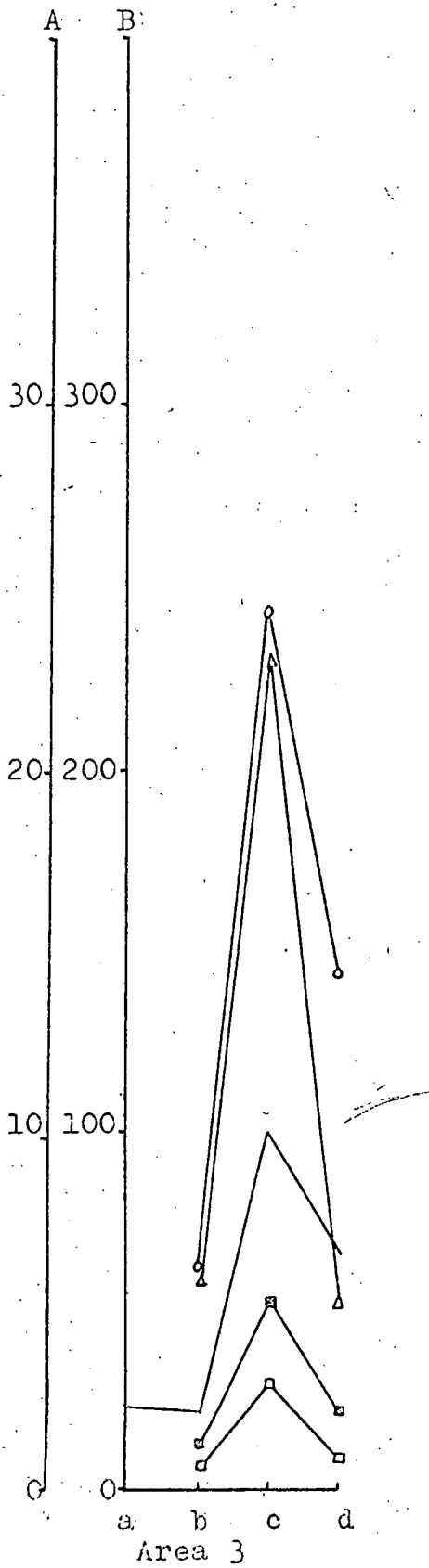

FIGURE 5.9

Cynosaurus cristatus

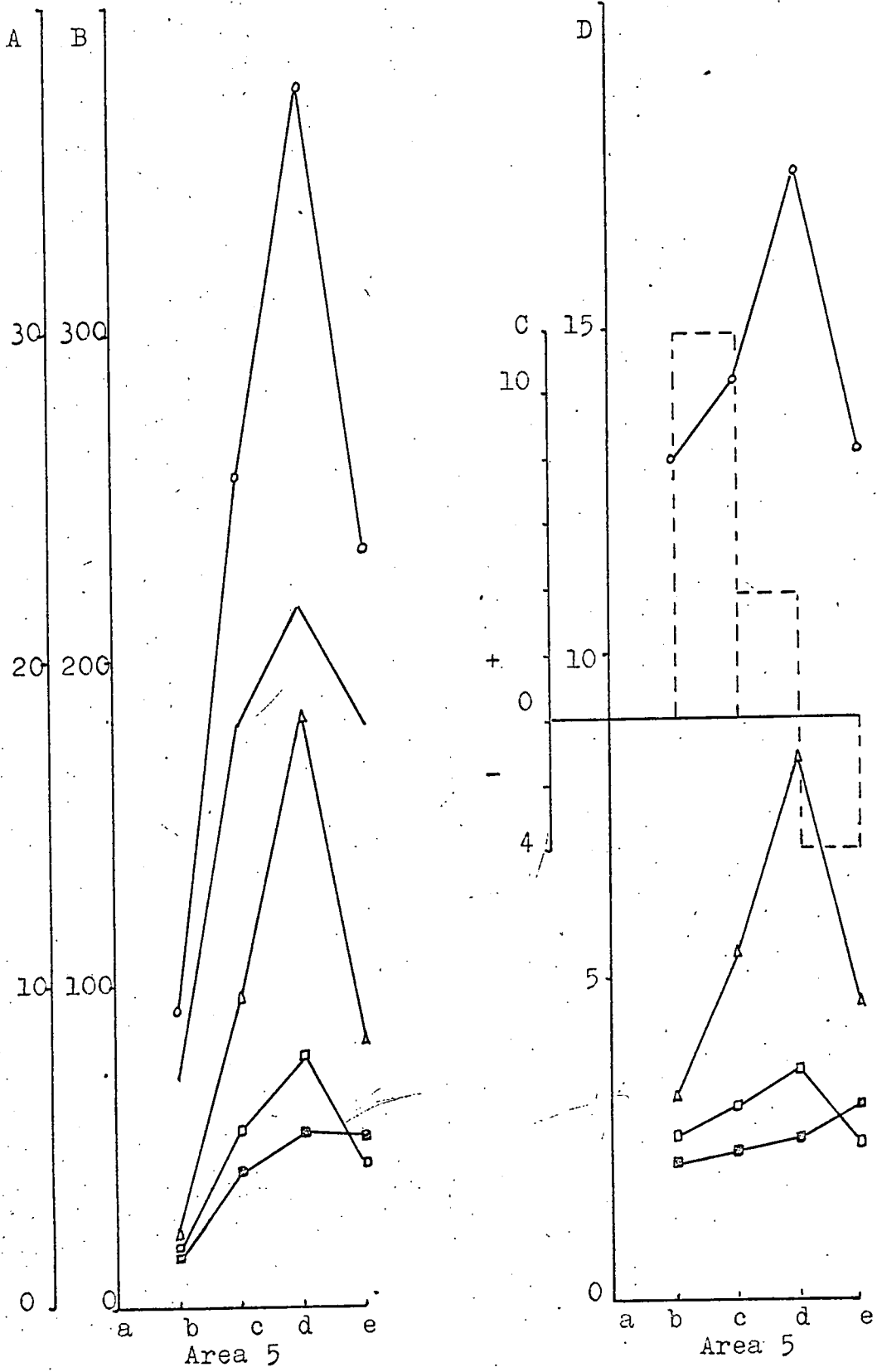

FIGURE 5.10

Eriophorum angustifolium

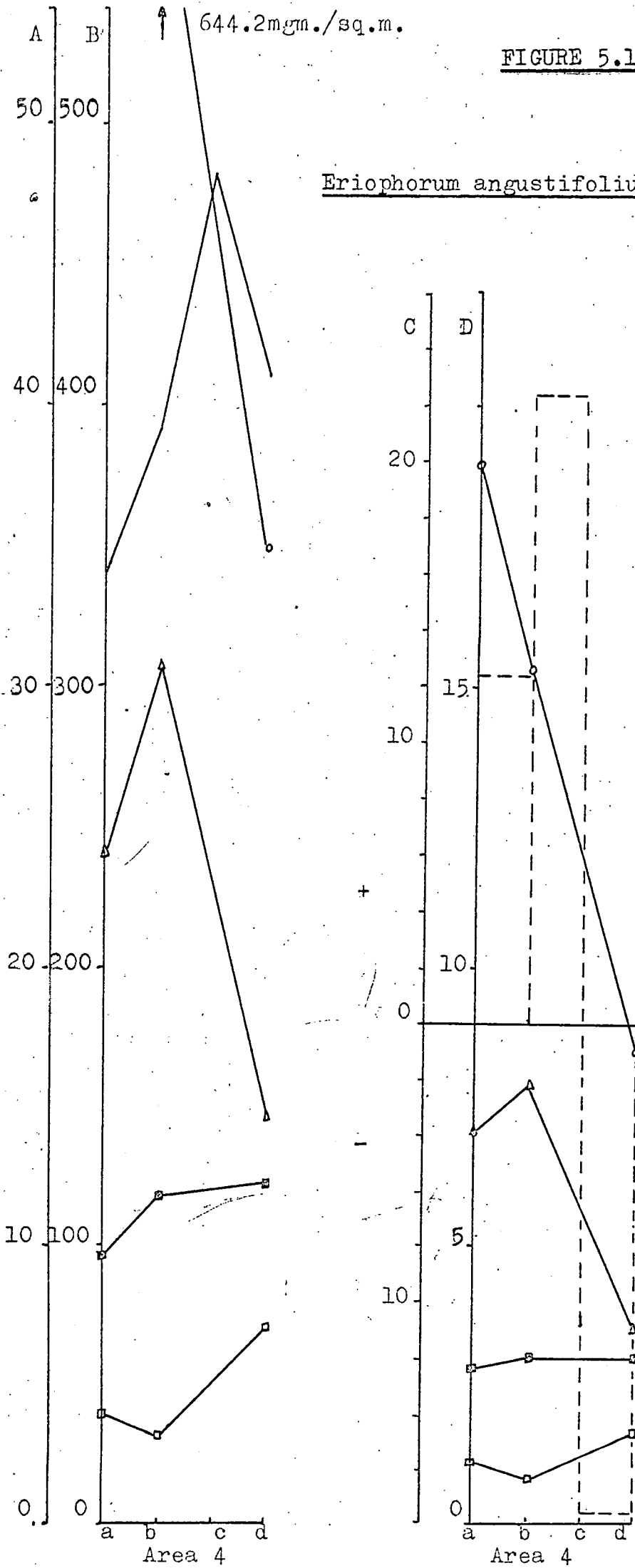
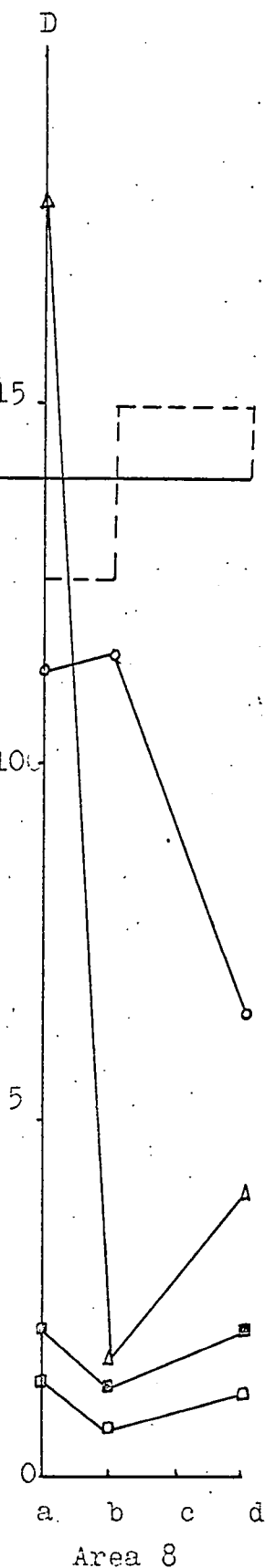
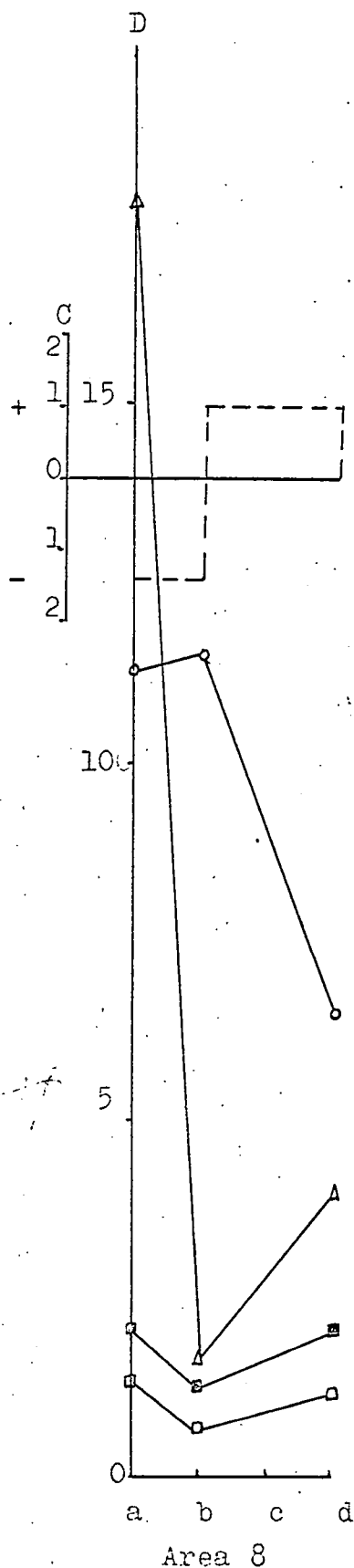
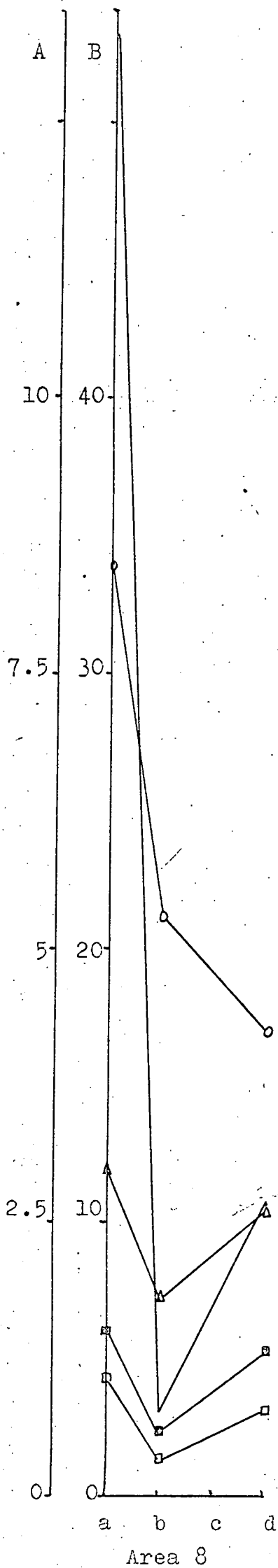
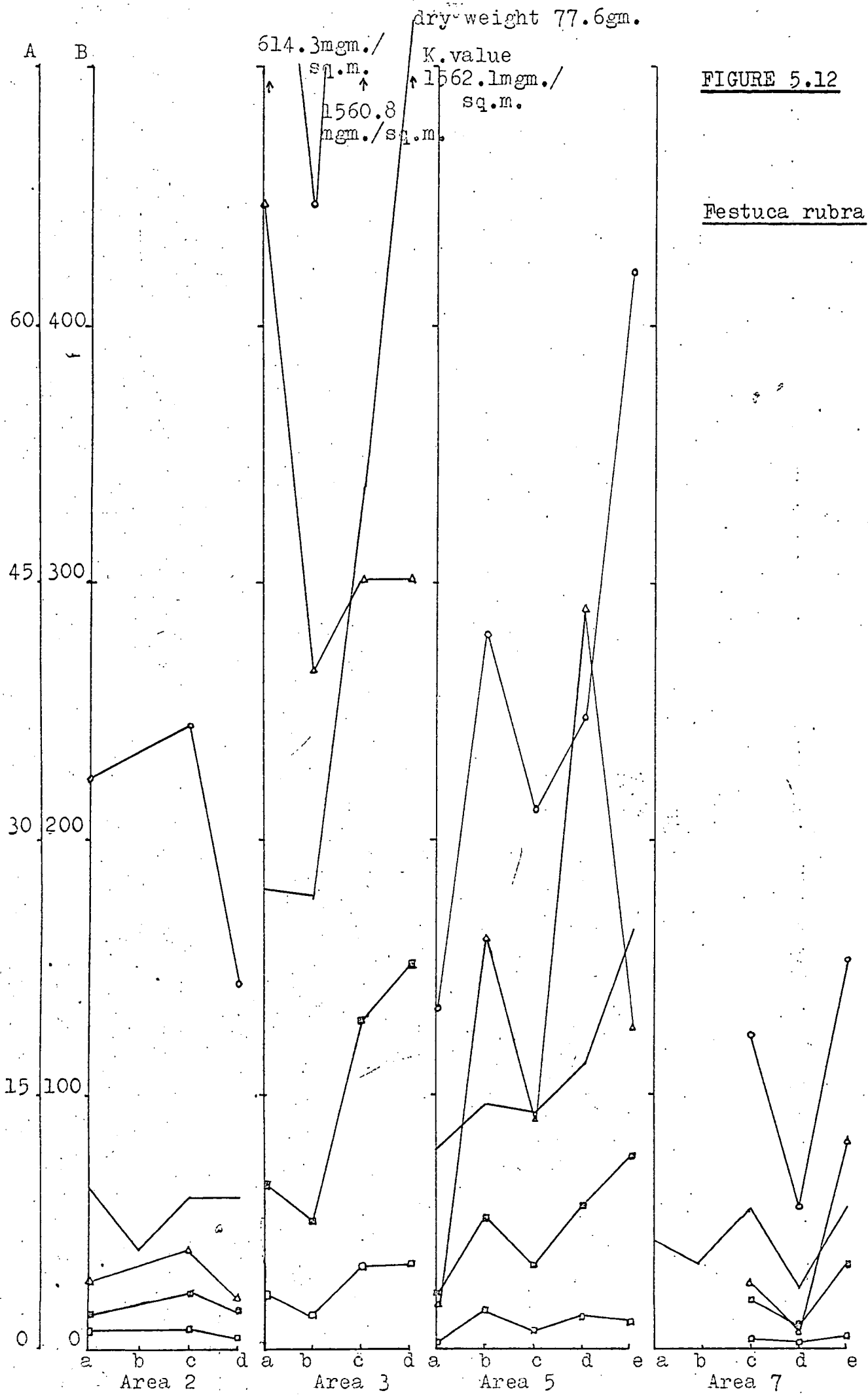

FIGURE 5.11

Festuca ovina





Festuca rubra

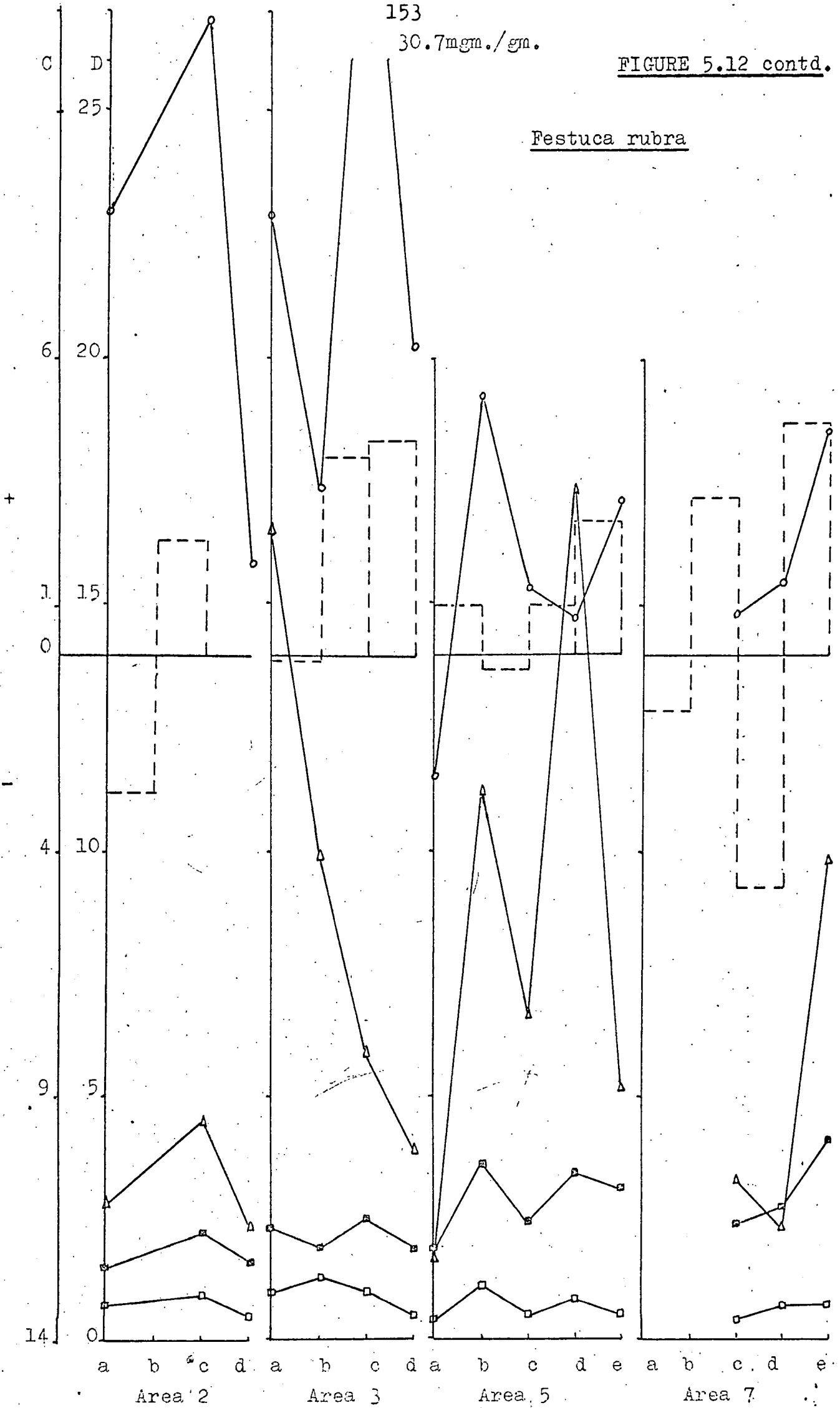
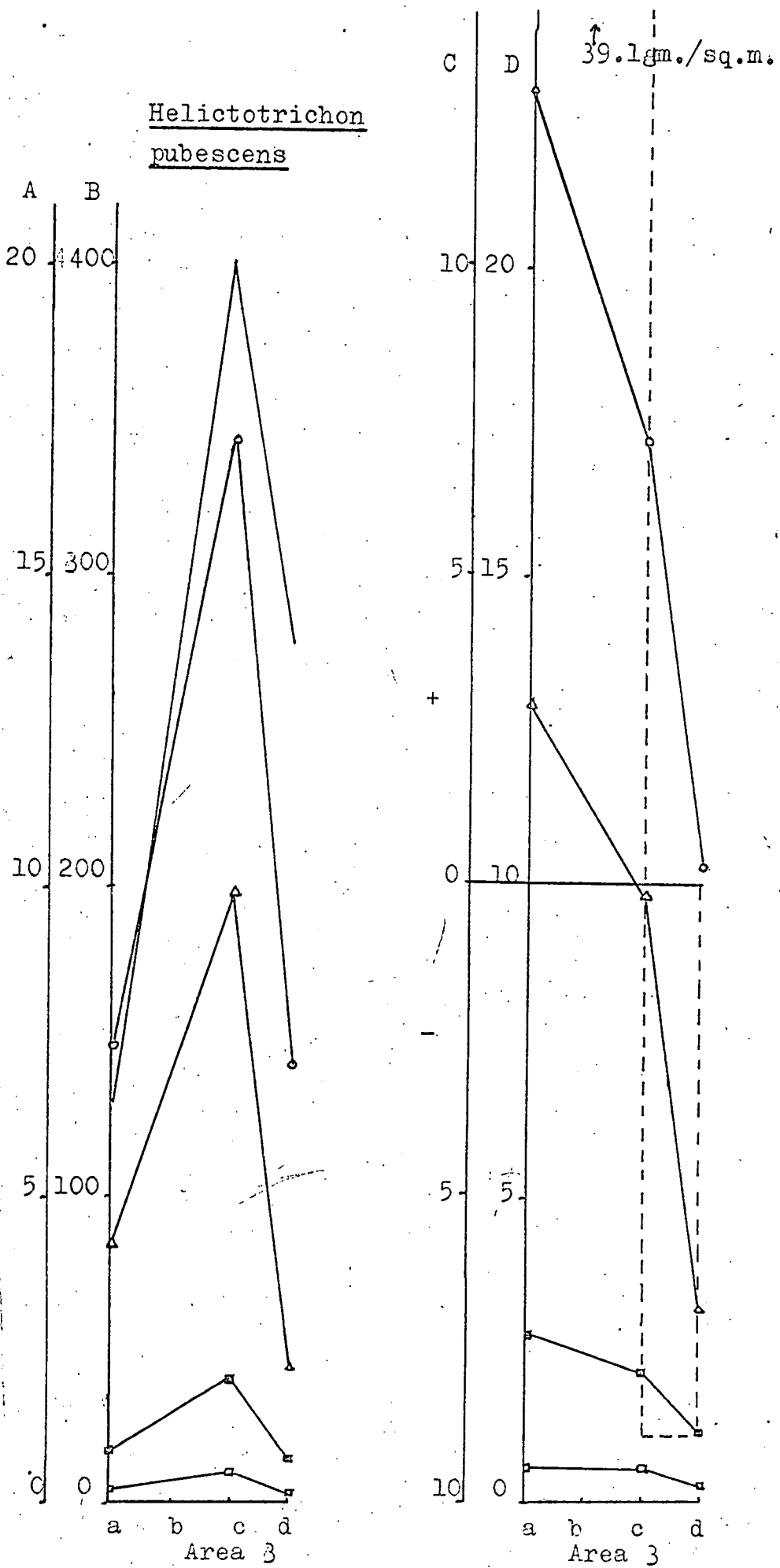
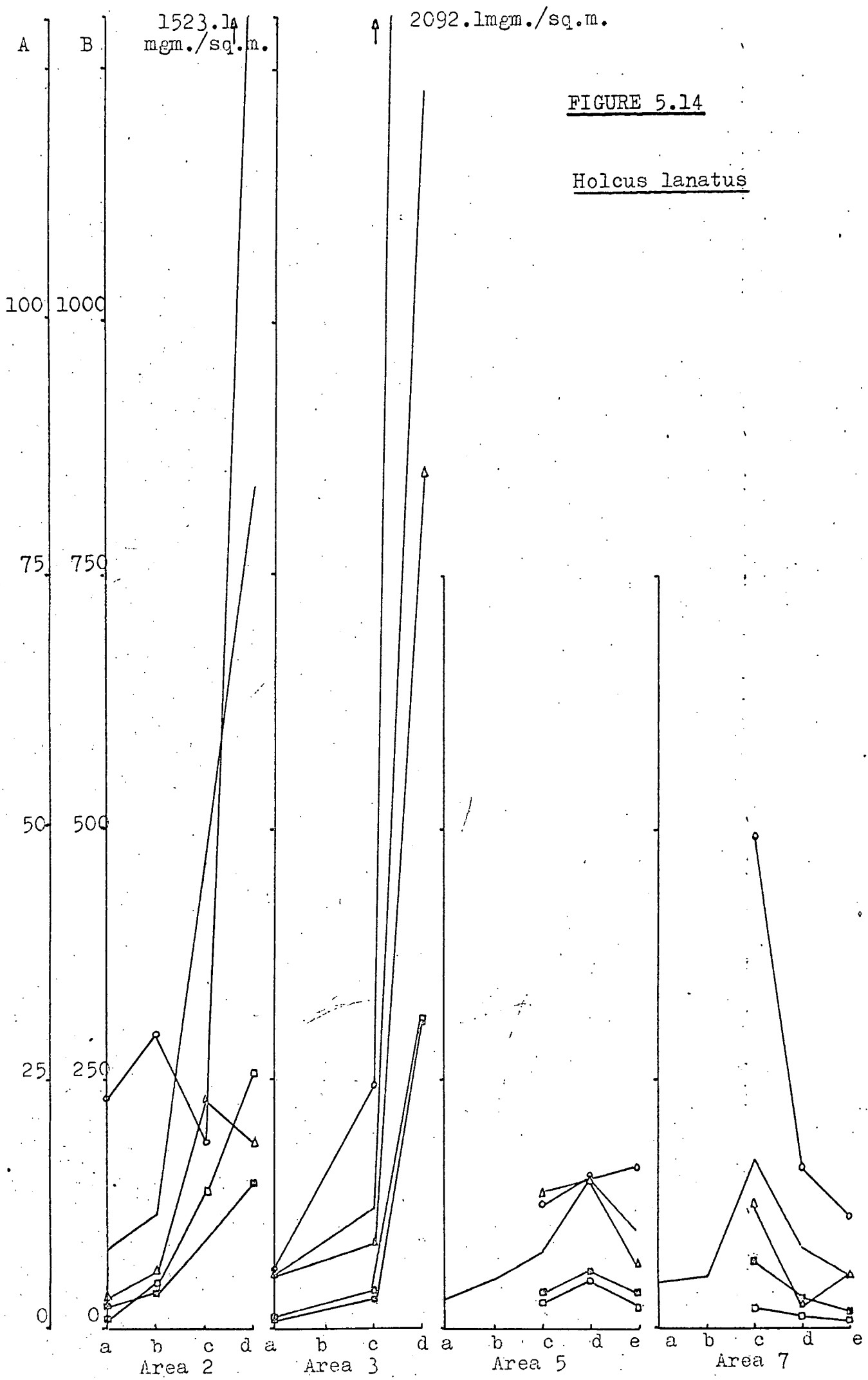
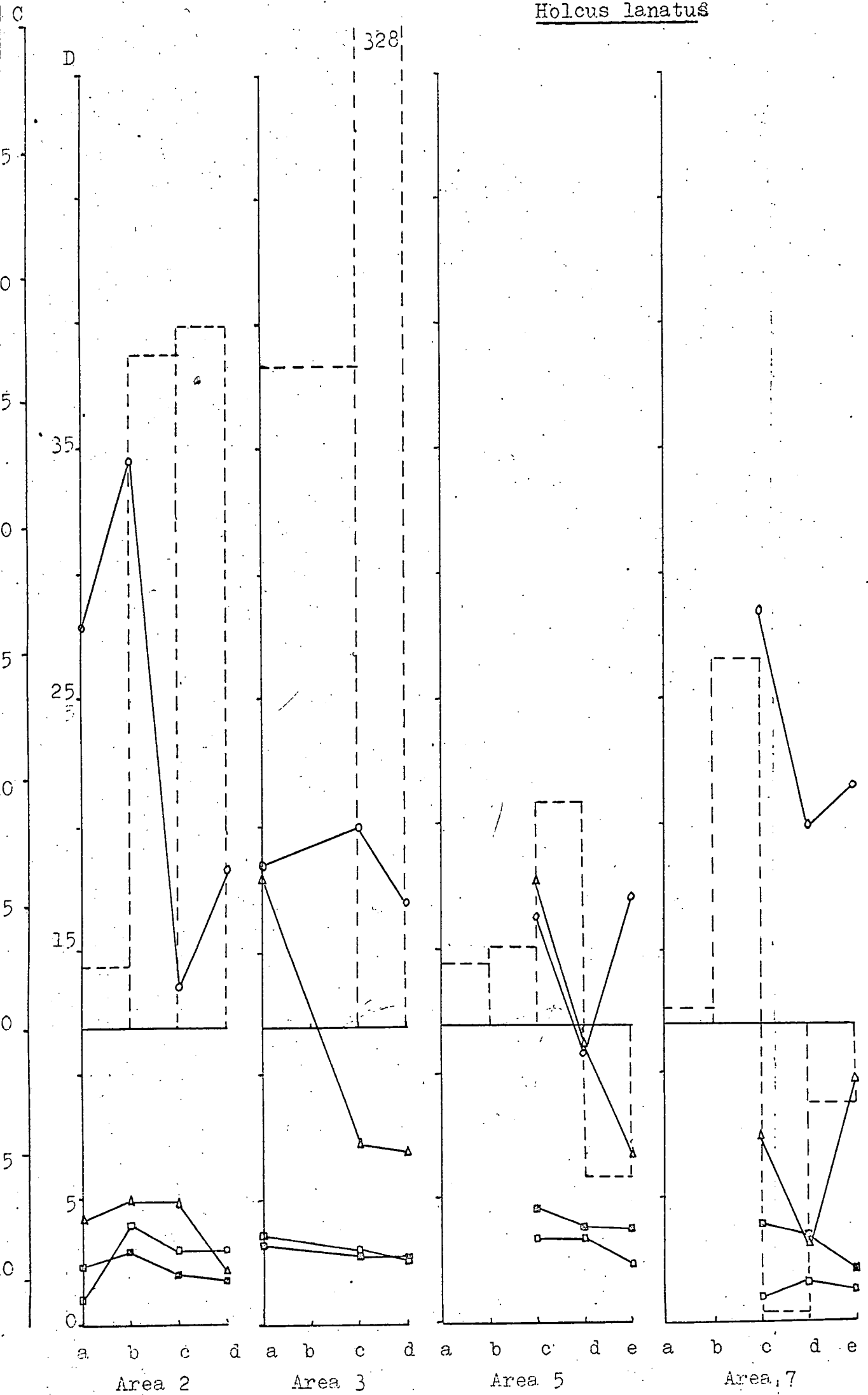

FIGURE 5.13





Holcus lanatus



Juncus squarrosus

FIGURE 5.15

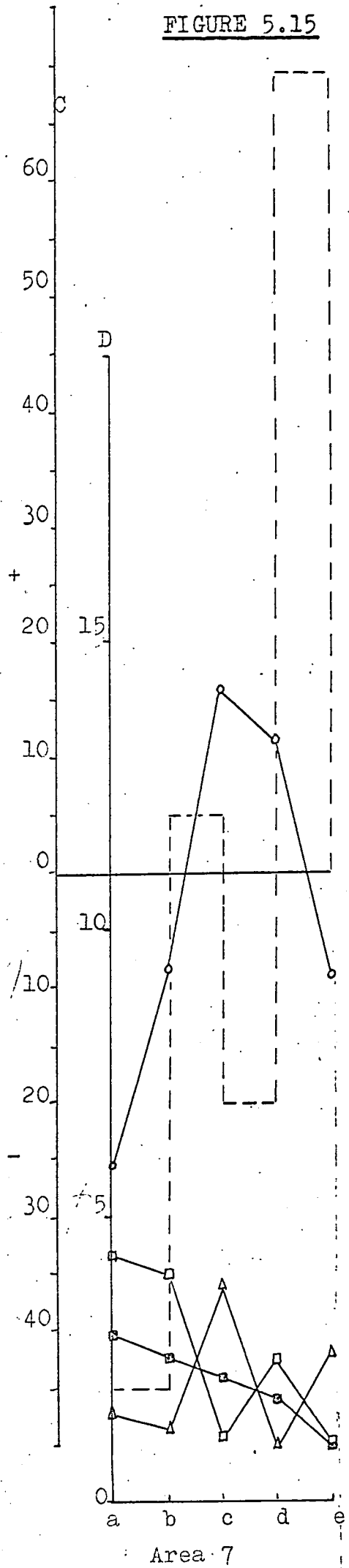
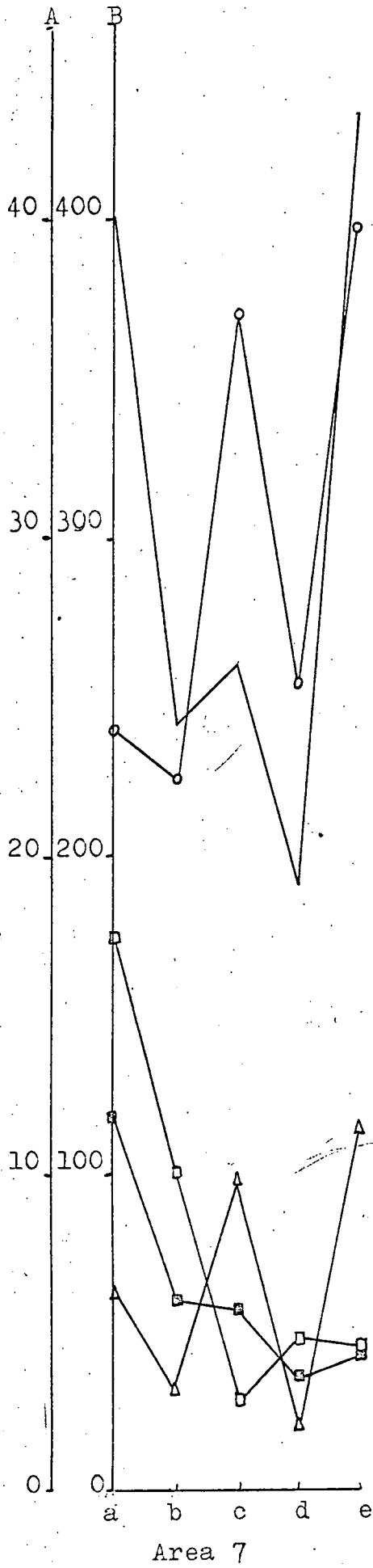

Molinia caerulea

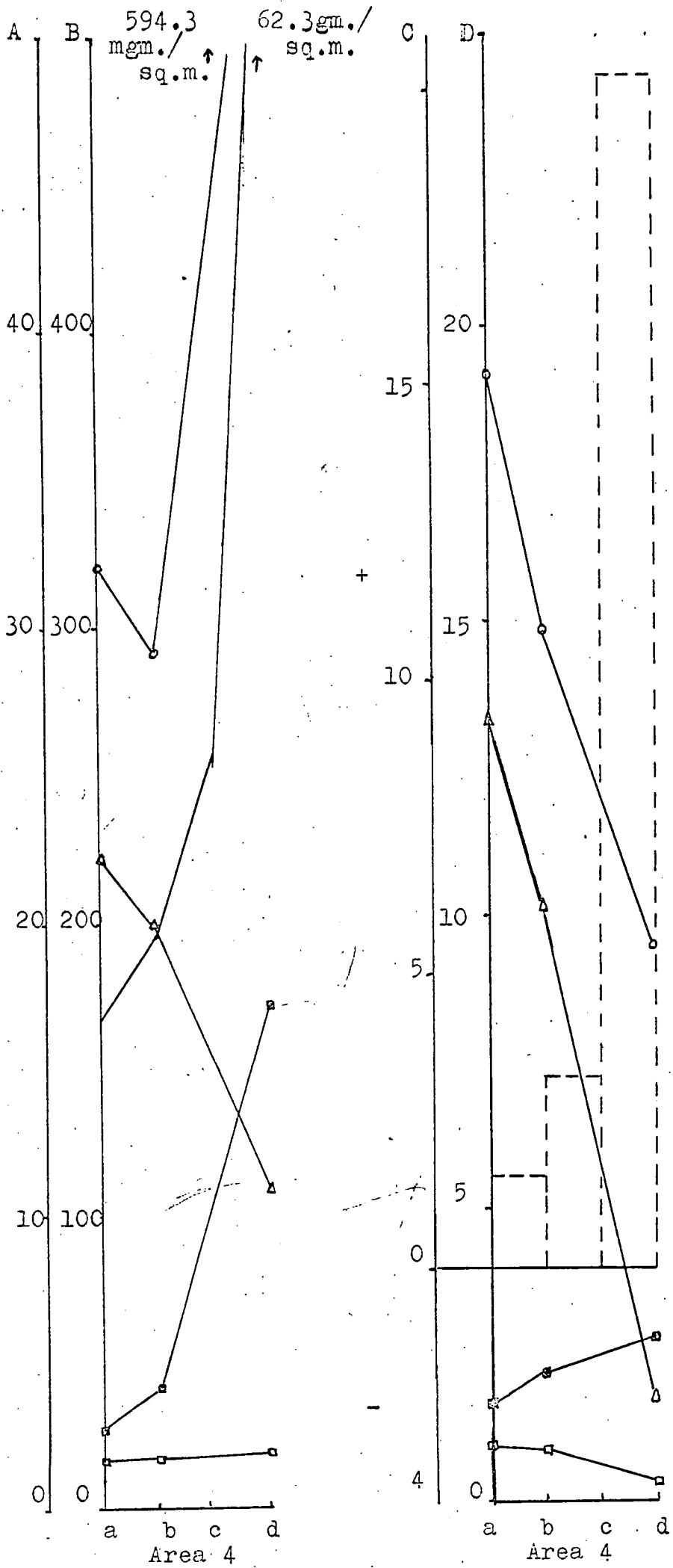

FIGURE 5.17

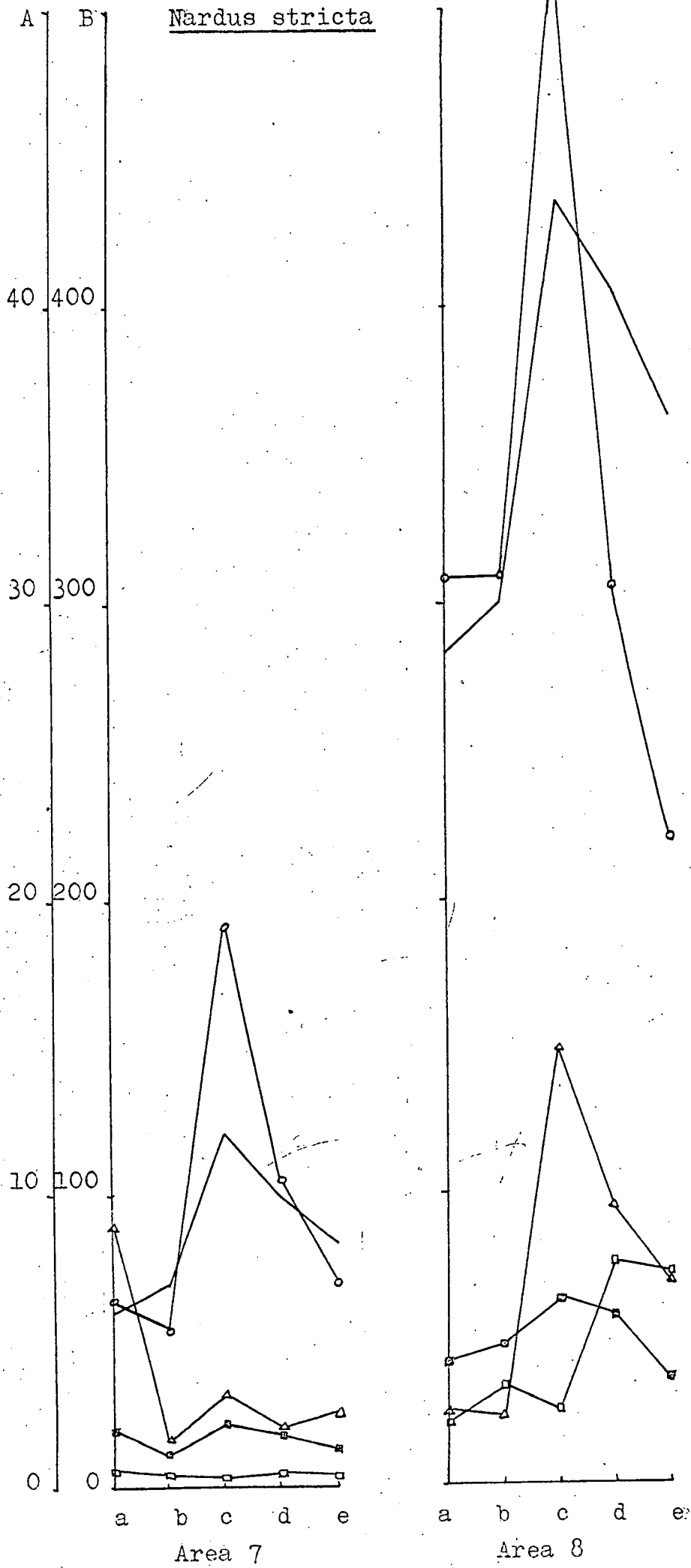
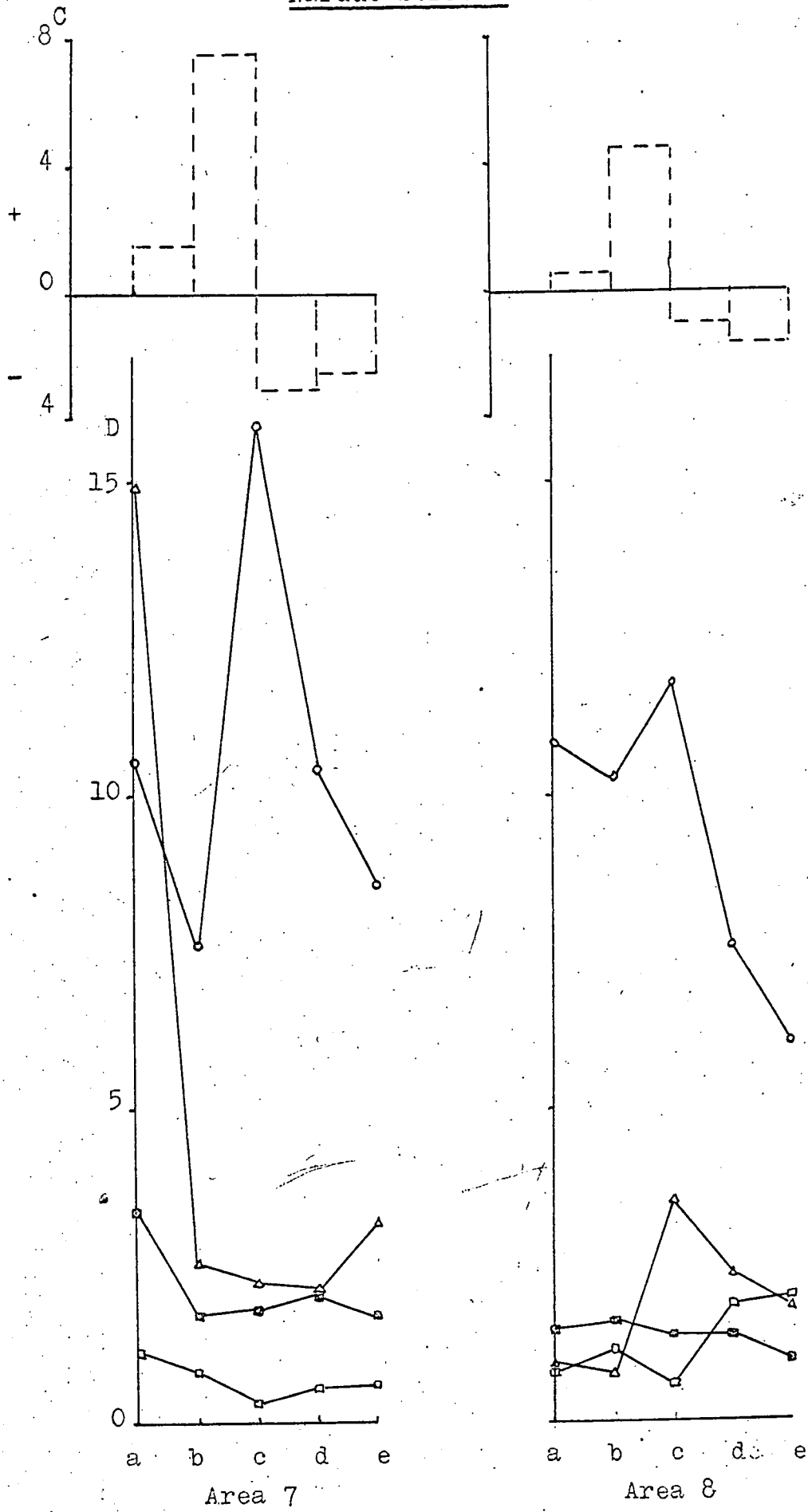
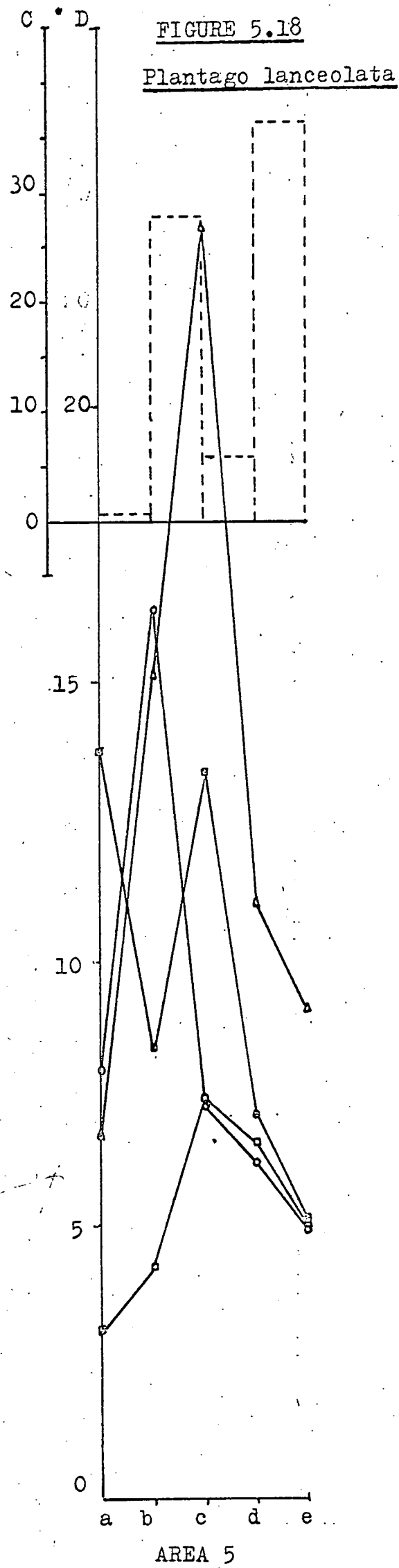
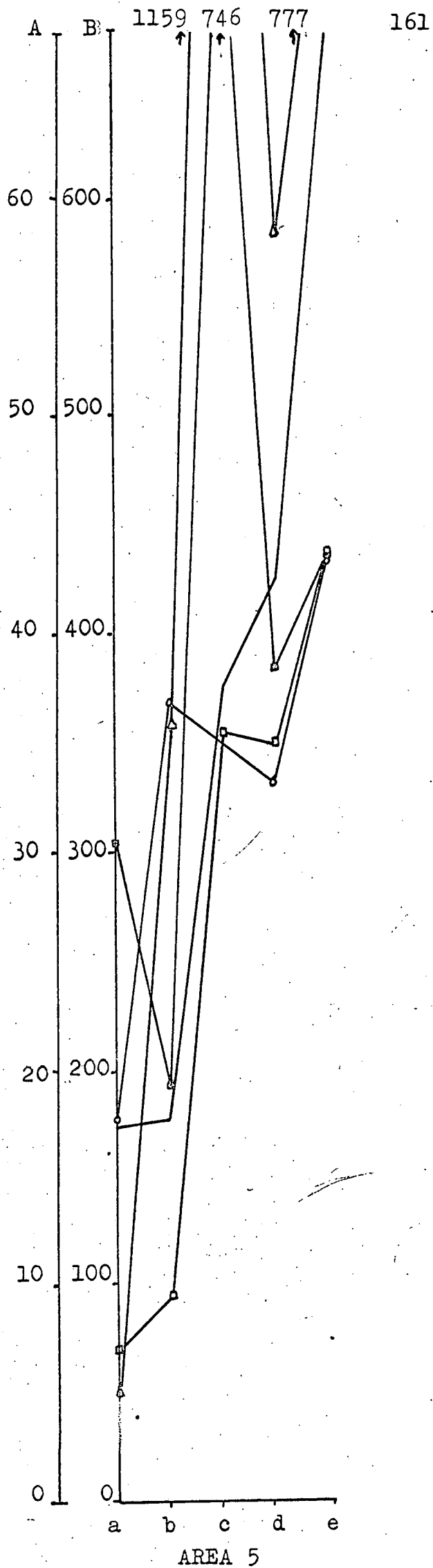

FIGURE 5.17 contd.

Nardus stricta





Poa trivialis

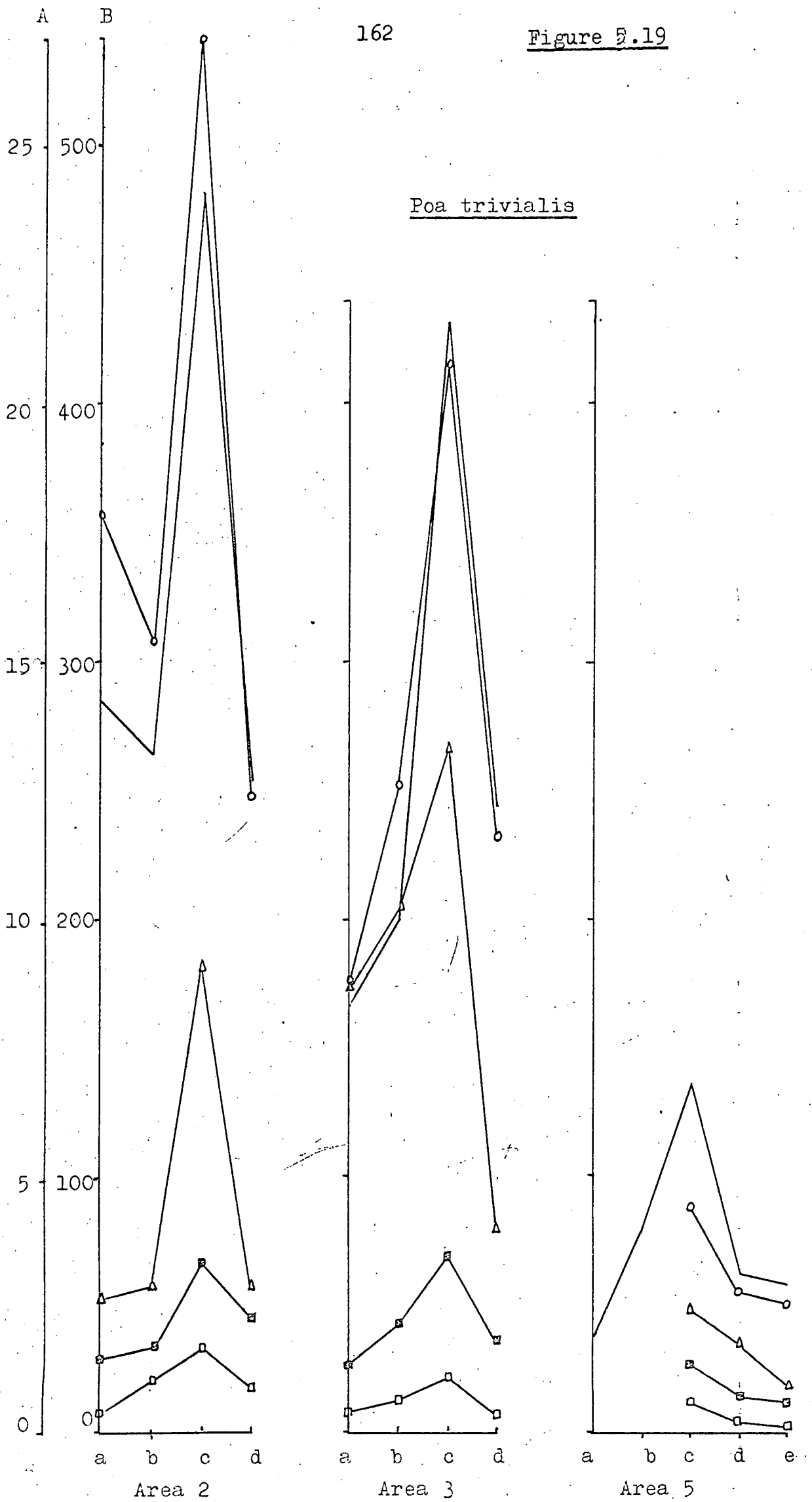

Poa trivialis

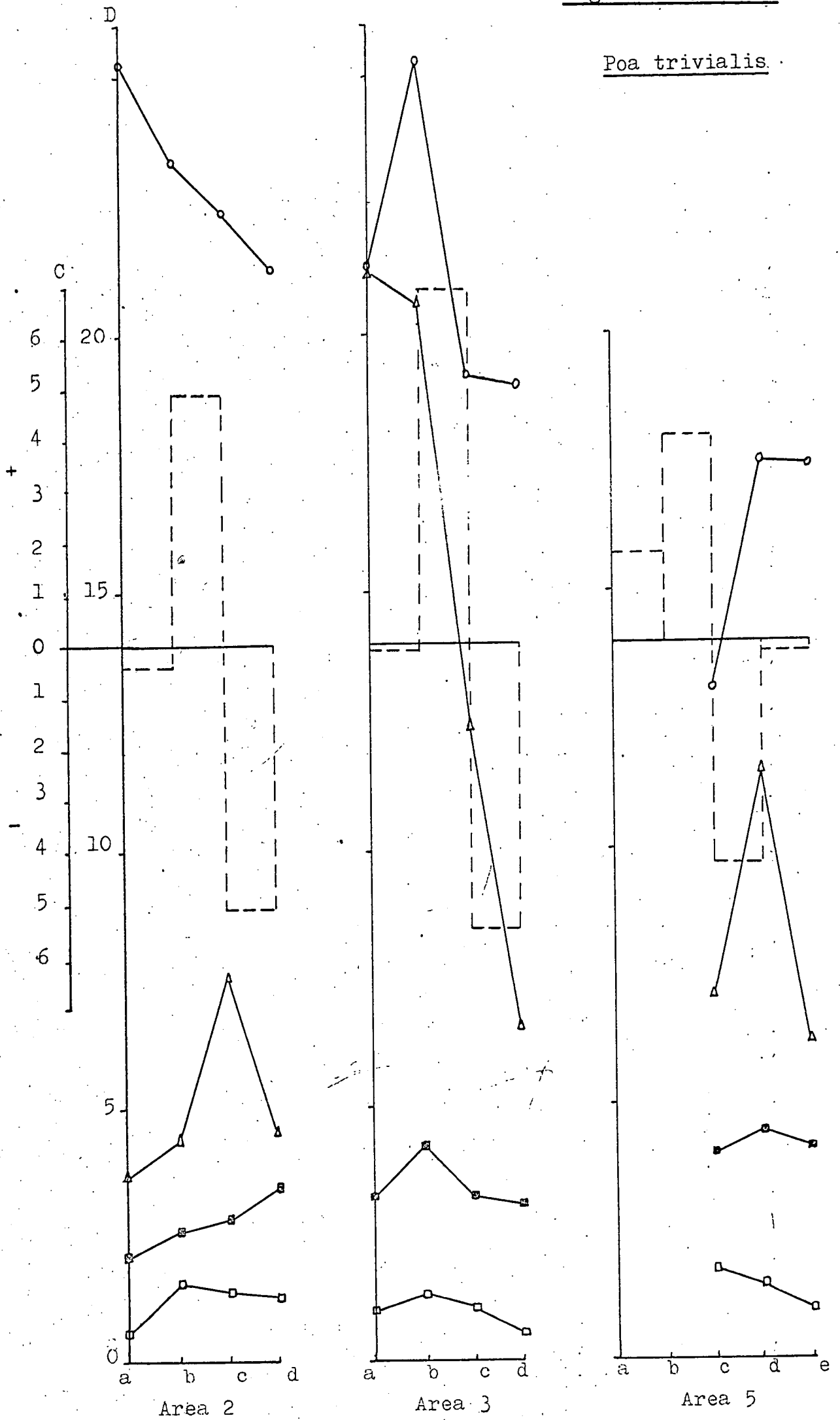

Ranunculus bulbosus

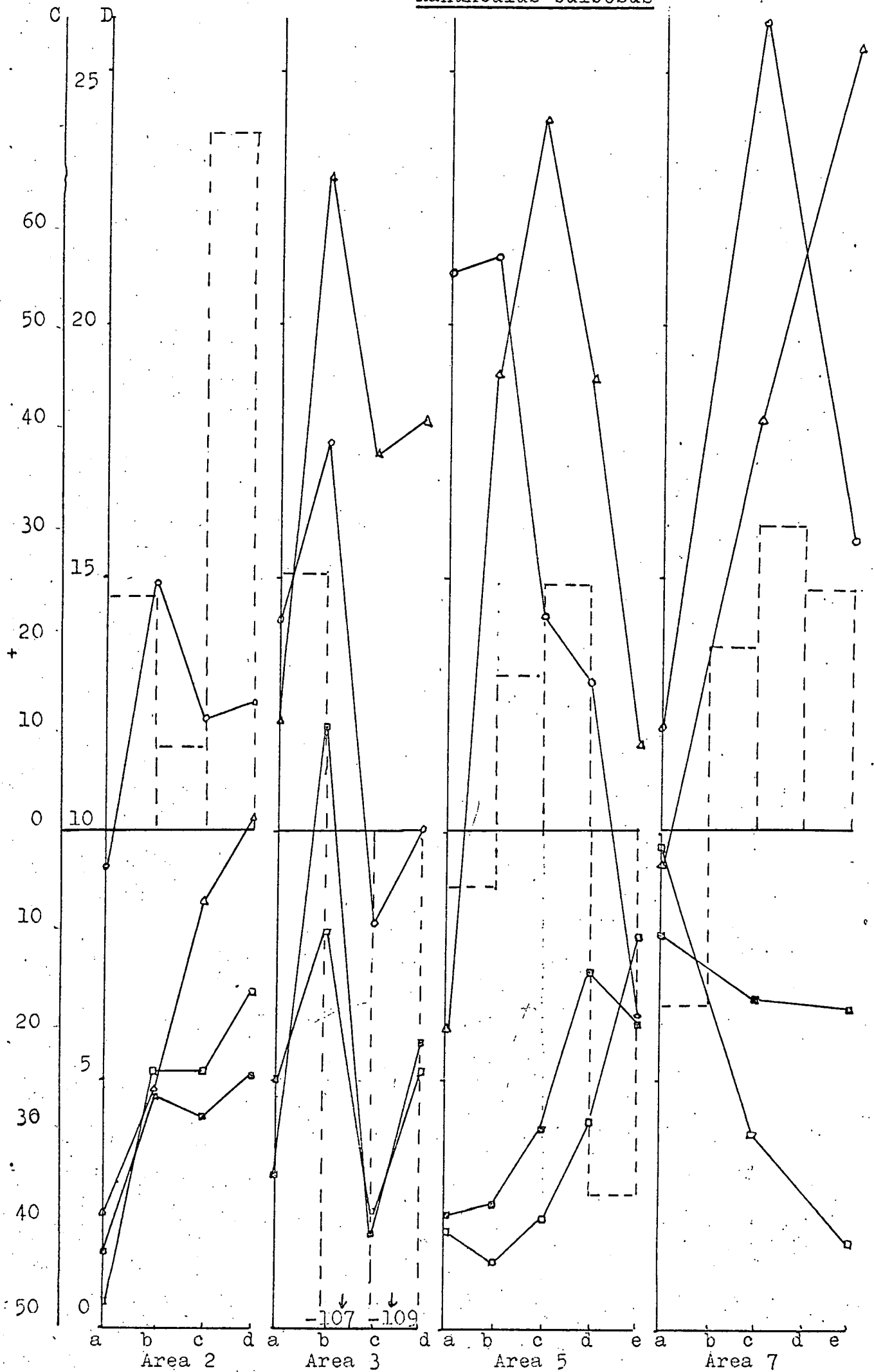

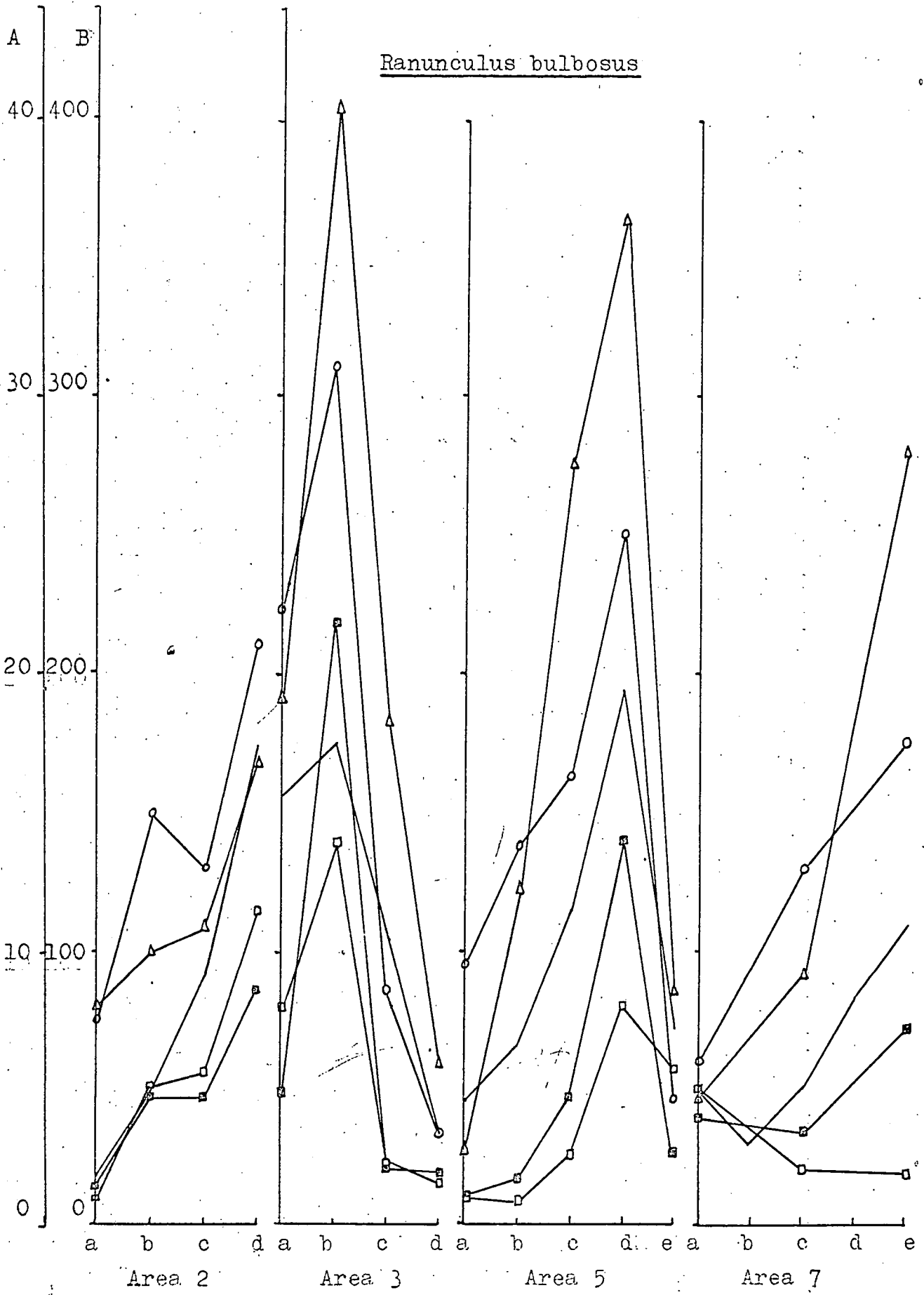
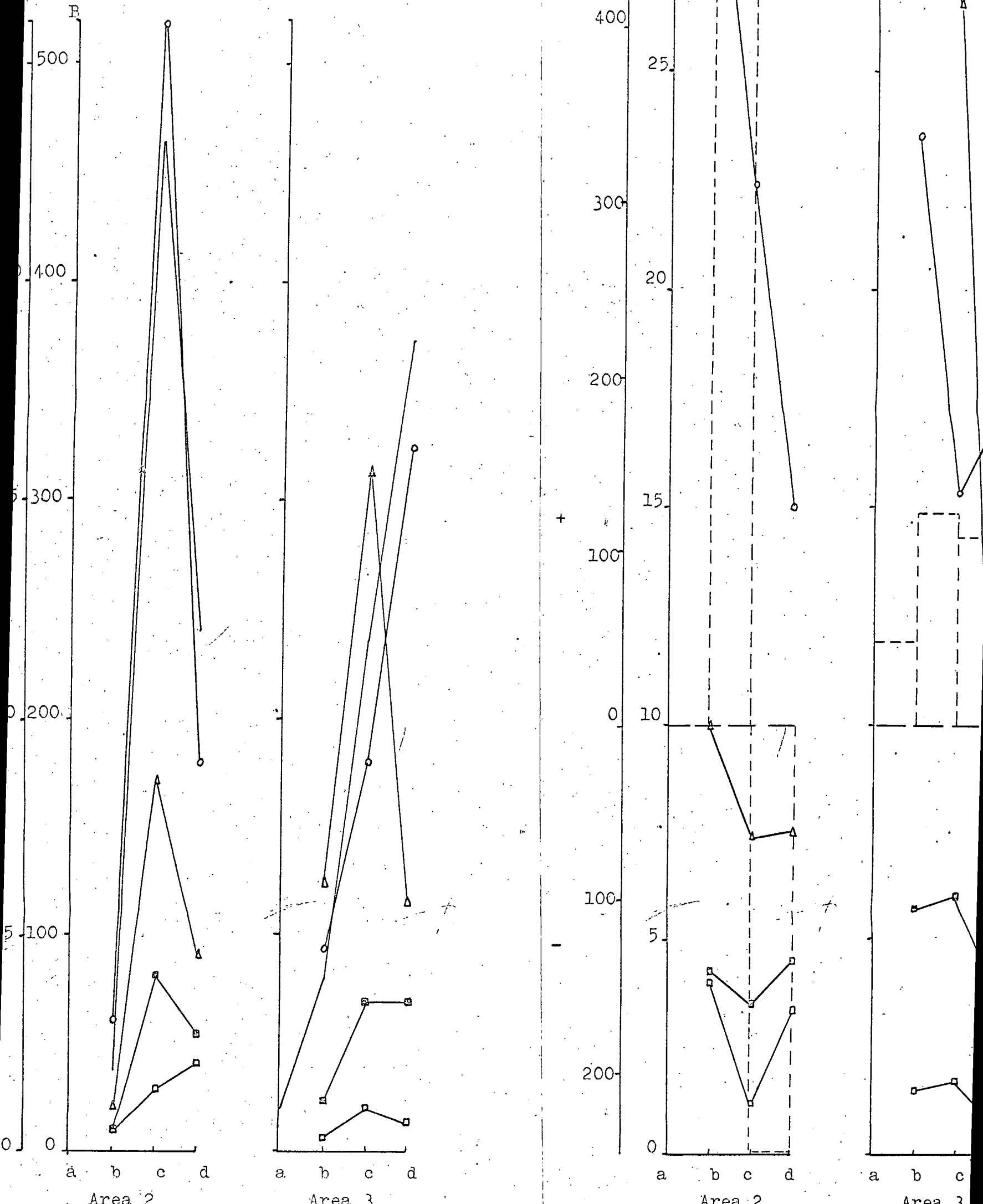
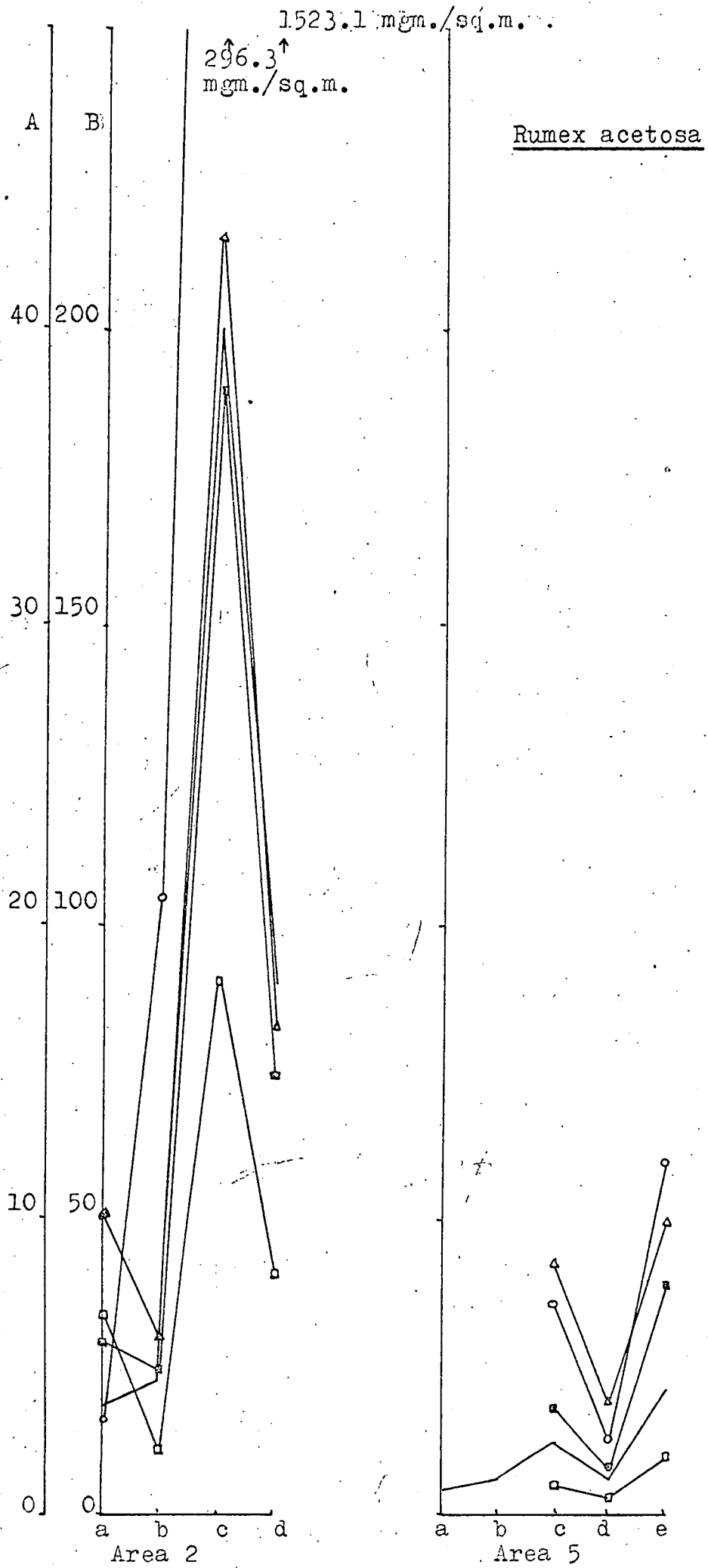
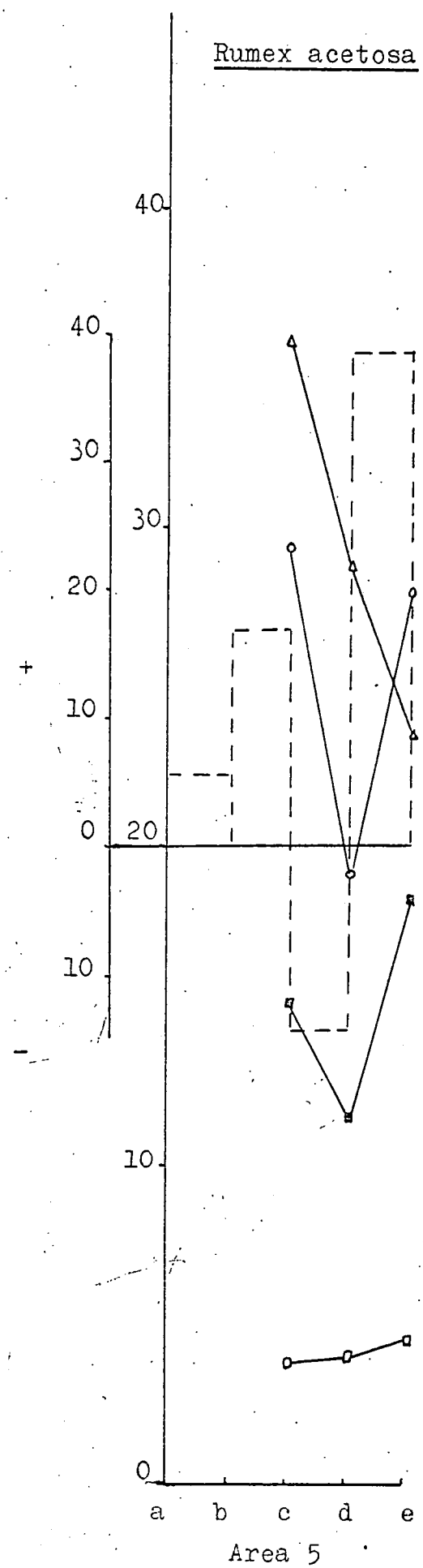
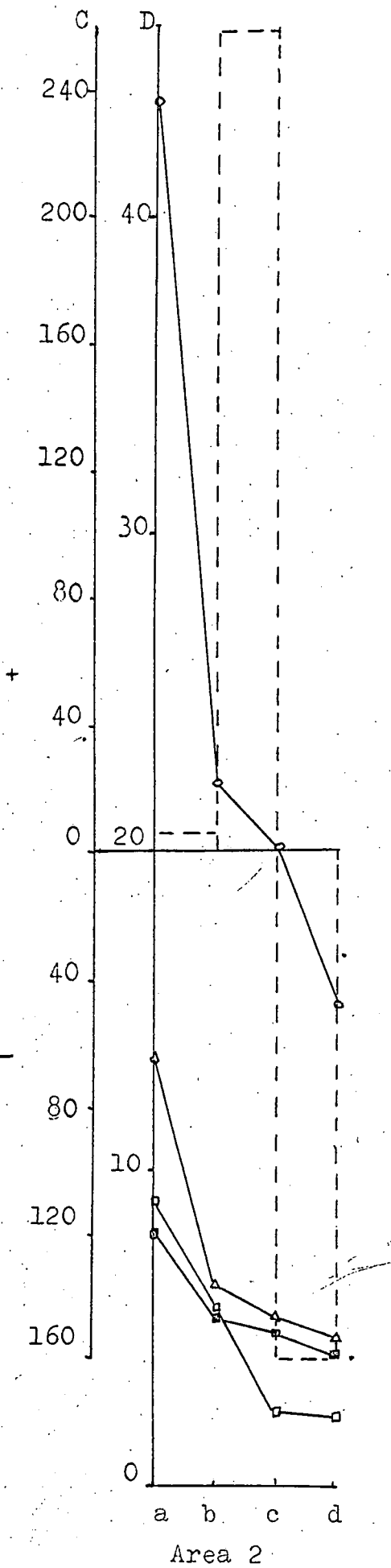

Figure 5.21

Rhinanthus minor







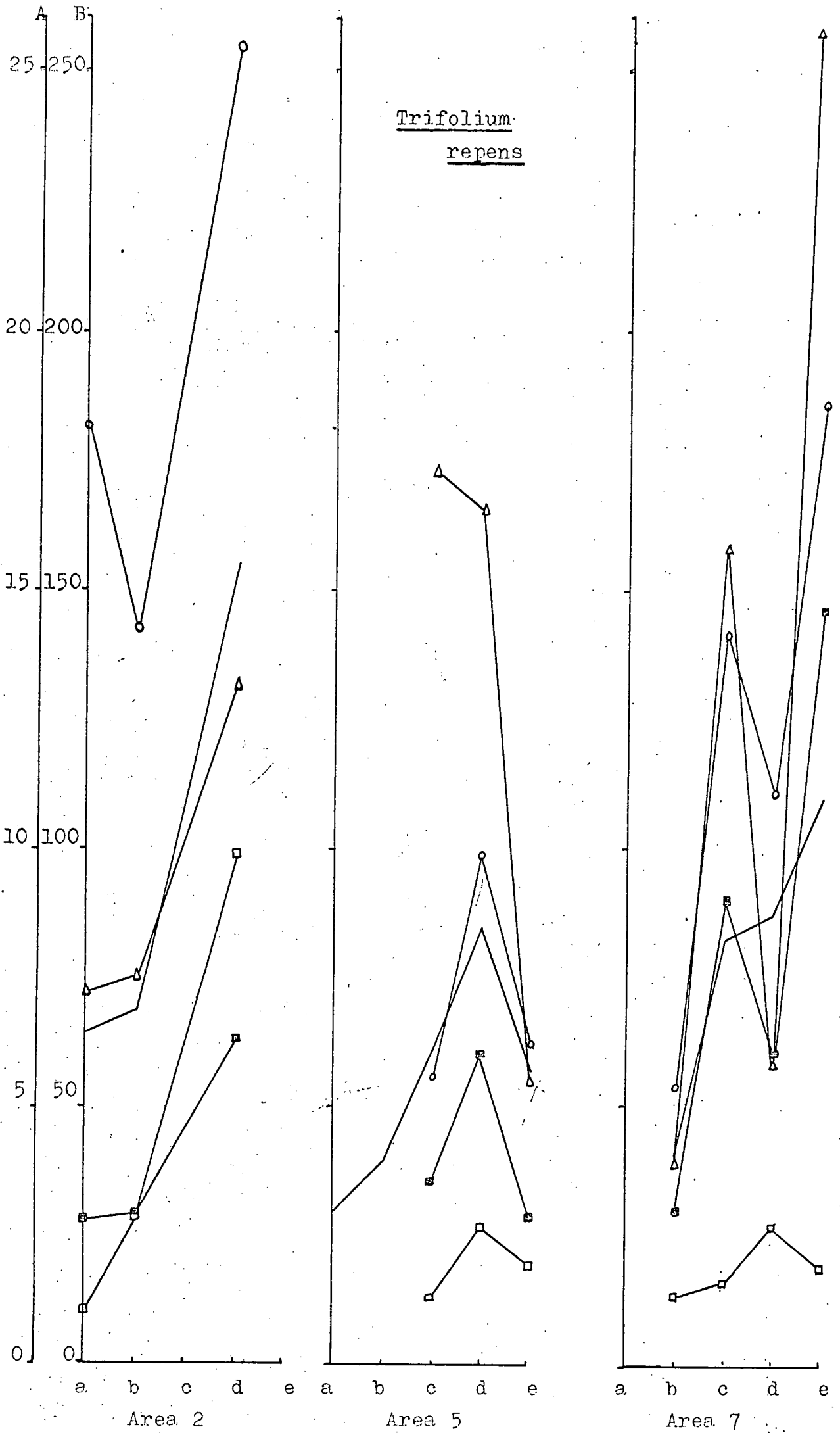

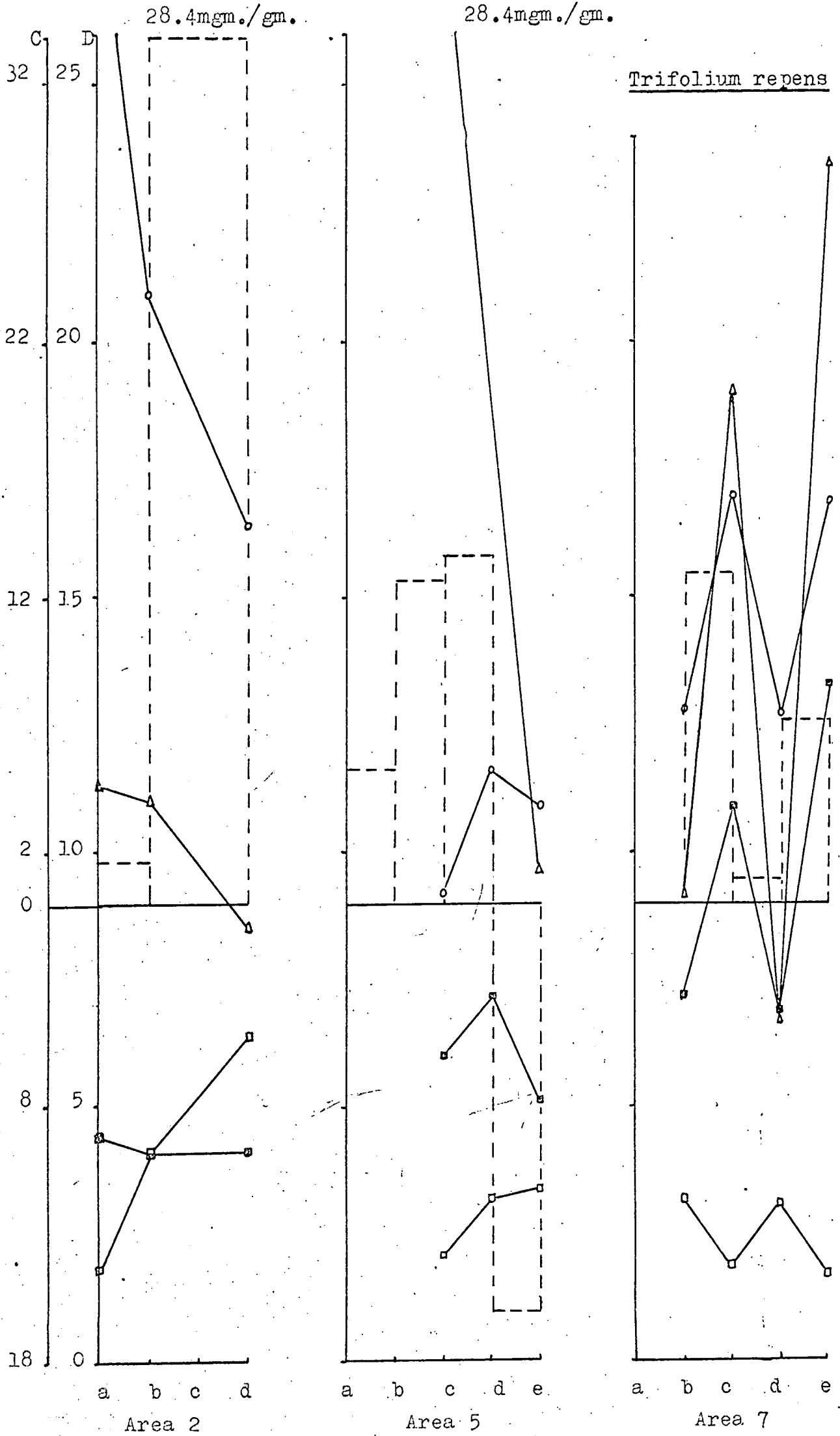

APPENDIX 6 Table 6.1

Mineral Analysis of the Whole Community

Date & Area	Dry weight g per m ²	Total of each mineral in community mg per m ²				Total weight of the 4 min- erals mg per m ²
		Na	K	Mg	Ca	
AREA 2						
24.5.68	158	198	2401	425	734	3758
7.6.68	177	437	2969	512	950	4868
21.6.68	338	686	5511	1052	2264	9513
11.7.68	346	938	5040	971	1527	8476
Uptake		740	3110	627	1530	6007
AREA 3						
24.5.68	191	291	2062	488	3483	6324
7.6.68	213	464	2592	848	2687	6591
21.6.68	268	548	5198	1879	5510	13135
11.7.68	508	591	6818	1553	4434	13396
Uptake		300	4756	1391	2823	9270
AREA 4						
24.5.68	193	161	1547	419	1925	4052
7.6.68	169	133	1422	507	1920	3982
21.6.68	294					
11.7.68	317	203	1830	857	1426	4316
Uptake		92	408	438	499	1437
AREA 5						
24.5.68	190	206	2578	1030	1730	5545
7.6.68	215	356	2875	978	2448	6607
21.6.68	260	662	2397	1693	3205	7957
11.7.68	307	907	3063	1511	4195	9676
5.8.68	411	860	3887	2321	3268	10336
Uptake		701	665	715	2465	4546
AREA 7						
24.5.68	386	850	2112	1205	2614	6781
7.6.68	246	369	1609	764	1147	3889
21.6.68	306	286	3359	1086	1961	6692
11.7.68	248	279	1944	649	1191	4063
5.8.68	307	318	3120	1097	3812	8347
Uptake		571	1750	556	1467	4344
AREA 8						
24.5.68	248	196	1337	369	1833	3735
7.6.68	238	190	1617	314	590	2711
21.6.68	383	309	1816	851	4642	7618
11.7.68	311	259	1631	704	2146	4740
5.8.68	404	402	1716	591	3340	6049
Uptake		119	479	537	4052	5087

APPENDIX 6 Table 6.2

Mineral Analysis of the Living Plant Material
of the Community

Date & Area	Dry weight g per m ²	Total of each mineral in living plant material mg per m ²				Total weight of the 4 min- erals mg/m ²
		Na	K	Mg	Ca	
AREA 2						
24.5.68	84	147	2020	260	439	2866
7.6.68	113	374	2537	363	581	3855
21.6.68	294	614	5107	922	1749	8392
11.7.68	288	837	4679	791	1131	7438
AREA 3						
24.5.68	98	209	1736	293	2006	4244
7.6.68	116	299	1900	581	1676	4456
21.6.68	266	380	4780	970	3348	9478
11.7.68	446	559	6531	1433	3770	12293
AREA 4						
24.5.68	78	91	1333	231	855	2510
7.6.68	81	73	1295	246	813	2427
21.6.68	112					
11.7.68	180	120	1635	523	675	2953
AREA 5						
24.5.68	136	179	2247	861	1262	4549
7.6.68	131	289	2501	738	2028	5556
21.6.68	177	539	2089	1394	1585	5607
11.7.68	222	814	2831	1242	3062	7949
5.8.68	305	787	3580	858	2193	8418
AREA 7						
24.5.68	187	552	1544	717	1706	4519
7.6.68	140	288	1383	509	753	2933
21.6.68	206	211	2855	746	1633	5445
11.7.68	178	236	1744	506	765	3251
5.8.68	224	270	2745	943	3040	6998
AREA 8						
24.5.68	109	98	945	200	839	2082
7.6.68	98	109	972	194	415	1690
21.6.68	169	144	1337	417	2298	4196
11.7.68	212	205	1357	530	1540	3632
5.8.68	220	250	1334	496	1938	4018

APPENDIX 6 Table 6.2 contd.Mineral Analysis of the Living Phanerogams
and Cryptogams

Date & Area	Dry weight of phanero- gams g/m ²	Total of each mineral in the living phanerogams mg per m ²				Total weight of the 4 min- erals mg/m ²
		Na	K	Mg	Ca	
<hr/>						
AREA 7						
24.5.68	97	311	1065	356	601	2333
7.6.68	87	235	1094	313	382	2024
21.6.68	121	146	2282	460	821	3720
11.7.68	106	173	1321	270	307	2072
5.8.68	151	215	2216	596	1469	4497
AREA 8						
24.5.68	62	51	740	90	484	1365
7.6.68	57	74	717	110	263	1164
21.6.68	79	77	1005	186	598	1866
11.7.68	57	115	703	158	271	1247
5.8.68	88	143	848	250	563	1823
<hr/>						
Date & Area	Dry weight of crypto- gams g/m ²	Total of each mineral in the living cryptogams mg per m ²				Total weight of the 4 min- erals mg/m ²
		Na	K	Mg	Ca	
<hr/>						
AREA 7						
24.5.68	90	241	479	361	1405	2186
7.6.68	53	53	289	196	355	893
21.6.68	85	65	573	276	812	1725
11.7.68	72	63	423	237	458	1180
5.8.68	73	55	529	347	1571	2501
AREA 8						
24.5.68	47	47	206	111	356	719
7.6.68	41	35	255	84	152	526
21.6.68	90	67	332	231	1700	2330
11.7.68	135	90	654	372	1270	2385
5.8.68	132	87	486	246	1376	2195

APPENDIX 6 Table 6.3Mineral Analysis of the Dead Plant Material
of the Community

Date & Area	Dry weight g per m ²	Total of each mineral in debris mg per m ²				Total weight of the 4 min- erals mg/m ²
		Na	K	Mg	Ca	
AREA 2						
24.5.68	76	51	381	165	295	892
7.6.68	64	63	433	149	369	1014
21.6.68	46	72	404	130	515	1121
11.7.68	58	101	361	180	396	1038
AREA 3						
24.5.68	93	82	326	195	1477	2080
7.6.68	98	165	692	267	1011	2135
21.6.68	103	169	418	909	2163	3659
11.7.68	61	232	286	120	664	1102
AREA 4						
24.5.68	115	70	214	188	1070	1542
7.6.68	87	60	127	261	1107	1555
21.6.68	181					
11.7.68	137	83	196	334	751	1364
AREA 5						
24.5.68	54	27	331	169	468	995
7.6.68	84	67	374	240	420	1101
21.6.68	84	123	308	299	1620	2350
11.7.68	80	93	232	269	1133	1727
5.8.68	97	73	306	463	1075	1918
AREA 7						
24.5.68	200	298	568	488	908	2262
7.6.68	108	80	226	255	394	955
21.6.68	101	75	504	340	327	1246
11.7.68	71	42	200	143	427	811
5.8.68	83	48	375	153	772	1348
AREA 8						
24.5.68	140	98	392	169	994	1653
7.6.68	141	82	645	120	175	1022
21.6.68	215	165	479	434	2344	3422
11.7.68	101	55	273	174	607	1109
5.8.68	185	152	382	95	1402	2031

APPENDIX 7 Table 7.1

Mineral Analysis of the Whole Community—Results
expressed as a Percentage of the Maximum Total

Date & Area	Weight of all minerals as a % of total dry weight	Each mineral as a percentage of 13396 (maximum total of the 4 minerals)			
		Na	K	Mg	Ca
AREA 2					
24.5.68	2.4	1.5	17.9	3.2	5.5
7.6.68	2.8	3.3	22.1	3.8	7.1
21.6.68	2.8	5.1	41.1	7.8	16.9
11.7.68	2.4	7.0	37.6	7.2	11.4
AREA 3					
24.5.68	3.3	2.2	15.4	3.6	26.0
7.6.68	3.1	3.5	19.3	6.3	20.1
21.6.68	4.9	4.1	38.7	14.0	41.1
11.7.68	2.6	4.4	50.8	11.6	33.1
AREA 4					
24.5.68	2.1	1.2	34.5	3.1	14.4
7.6.68	2.4	1.0	10.6	3.8	14.3
21.6.68					
11.7.68	1.4	1.5	13.6	6.4	10.6
AREA 5					
24.5.68	2.9	1.5	19.2	7.7	12.9
7.6.68	3.1	2.7	21.5	7.3	18.3
21.6.68	3.0	5.0	17.9	12.6	23.9
11.7.68	3.2	6.8	22.9	11.2	31.3
5.8.68	2.6	6.4	29.0	17.3	24.4
AREA 7					
24.5.68	1.7	6.3	15.7	9.0	19.5
7.6.68	1.6	2.8	12.0	5.7	8.6
21.6.68	2.2	2.1	25.0	8.1	14.6
11.7.68	1.6	2.1	14.5	4.8	8.9
5.8.79	2.7	2.4	23.3	8.2	28.4
AREA 8					
24.5.68	1.5	1.5	10.0	2.7	13.7
7.6.68	1.1	1.4	12.1	2.3	4.4
21.6.68	2.0	2.3	13.5	6.3	34.6
11.7.68	1.5	1.9	12.2	5.2	16.0
5.8.68	1.5	3.0	12.8	4.4	24.9

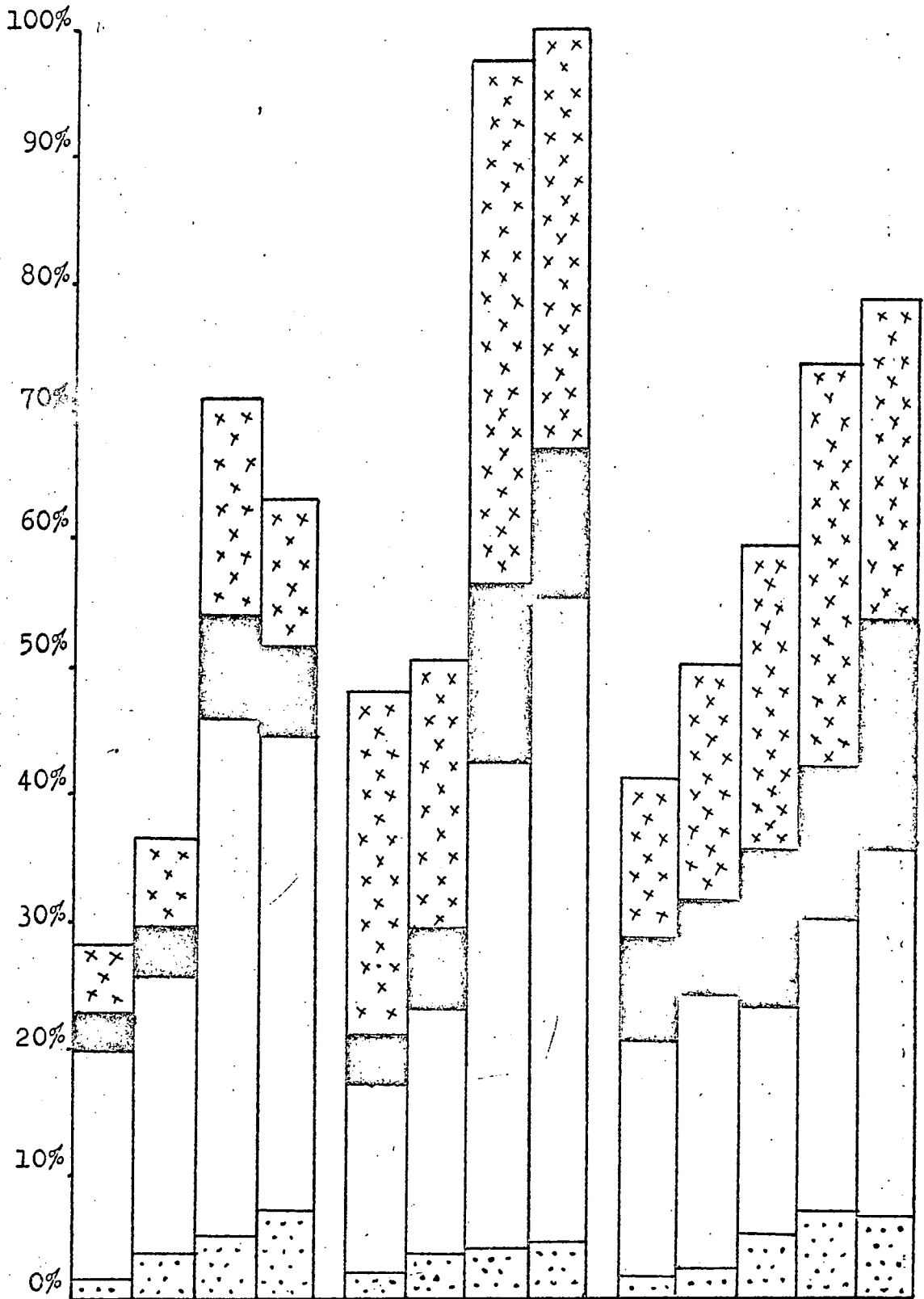

AREA 2

KEY

Potassium.. [diagonal lines]

Sodium..... [dotted]

Magnesium.. [horizontal lines]

Calcium.... [x x x]

AREA 3

AREA 5

FIGURE 7.1 The amount of sodium, potassium, magnesium and calcium present in the whole community—expressed as a percentage of the maximum total found. (see Table 7.1)

100%
90%
80%
70%
60%
50%
40%
30%
20%
10%
0%

FIGURE 7.1 contd.

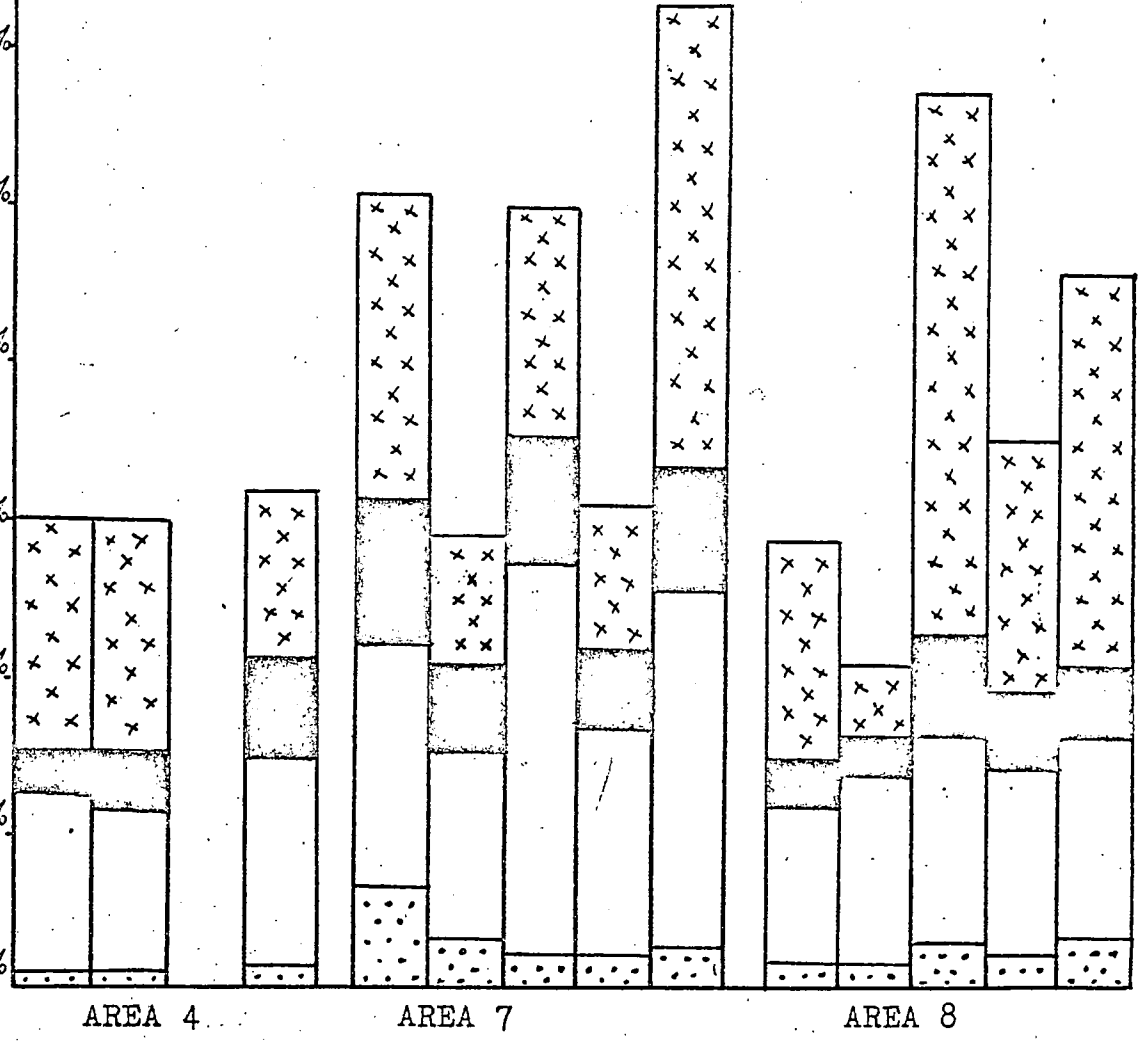

APPENDIX 7 Table 7.2Mineral Analysis of the Living Plant Material
of the Community

Date & Area	Weight of all minerals as a % of total dry weight	Each mineral as a percentage of 12293 (maximum total of the four minerals)			
		Na	K	Mg	Ca
AREA 2					
24.5.68	3.4	1.2	16.4	2.1	3.5
7.6.68	3.4	3.0	20.6	2.9	4.7
21.6.68	2.9	5.0	41.5	7.5	14.2
11.7.68	2.6	6.8	38.1	6.4	9.2
AREA 3					
24.5.68	4.3	1.7	14.1	2.4	16.3
7.6.68	3.8	2.4	15.5	4.7	13.6
21.6.68	3.6	3.1	38.9	7.9	27.2
11.7.68	2.8	4.5	53.1	11.7	30.7
AREA 4					
24.5.68	3.2	0.7	10.8	1.9	6.9
7.6.68	3.0	0.6	10.5	2.0	6.6
21.6.68					
11.7.68	1.6	1.0	13.3	4.2	5.5
AREA 5					
24.5.68	3.3	1.4	18.2	7.0	10.3
7.6.68	4.2	2.3	20.3	6.0	16.5
21.6.68	3.2	4.4	17.0	11.3	12.9
11.7.68	3.6	6.6	23.0	10.1	25.0
5.8.68	2.8	6.2	29.1	15.1	17.8
AREA 7					
24.5.68	2.4	4.5	12.5	5.8	13.9
7.6.68	2.1	2.3	11.2	4.1	6.0
21.6.68	2.6	1.7	23.2	6.1	13.3
11.7.68	1.8	1.9	14.2	4.1	6.2
5.8.68	3.1	2.2	22.3	7.7	24.7
AREA 8					
24.5.68	1.9	0.8	77.7	1.6	6.8
7.6.68	1.7	0.9	77.9	1.6	3.4
21.6.68	2.5	1.2	10.9	3.4	18.7
11.7.68	1.7	1.7	11.0	4.3	12.7
5.8.68	1.8	2.0	10.8	4.0	17.7

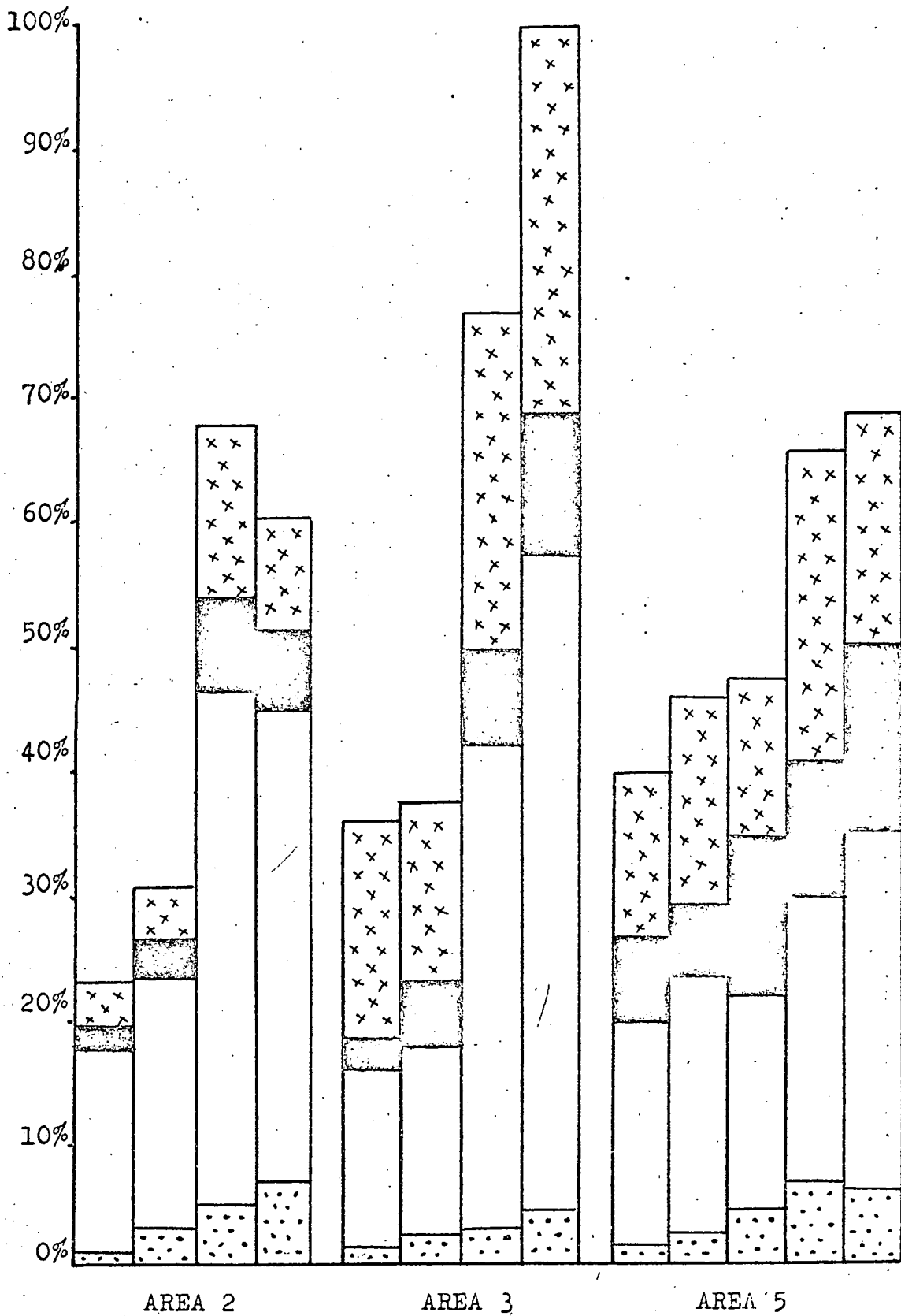
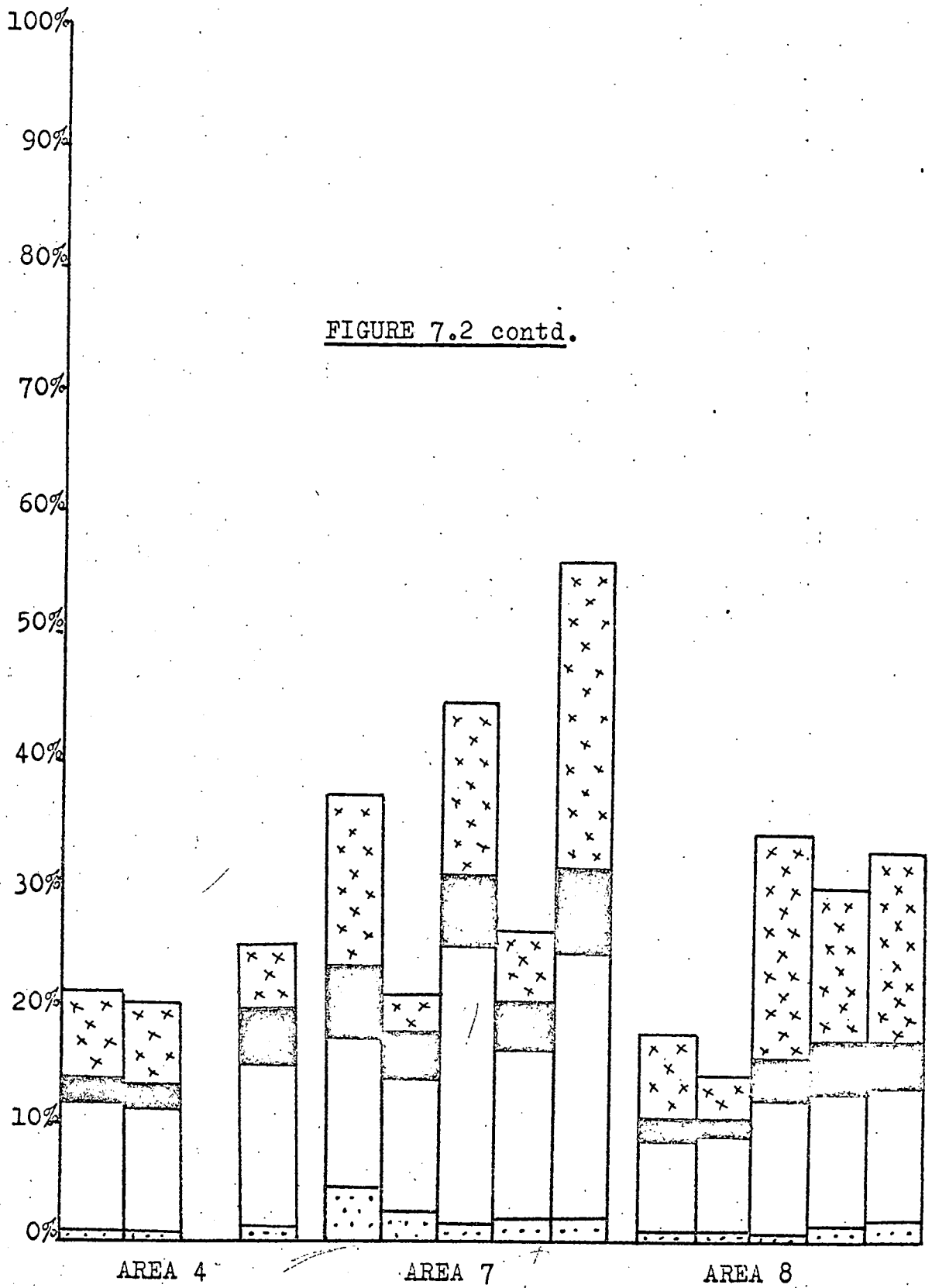

FIGURE 7.2 The amount of sodium, potassium, magnesium and calcium present in the living plant material-expressed as a percentage of the maximum total found. (see Table 7.2)



APPENDIX 7 Table 7.3

Mineral Analysis of the Dead Plant Material
of the Community.

Date & Area	Weight of all minerals as a % of the total dry weight	Each mineral as a percentage of 3659 (maximum total of all 4 minerals)			
		Na	K	Mg	Ca
AREA 2					
24.5.68	1.2	1.4	10.4	4.5	8.1
7.6.68	1.6	1.7	11.8	4.1	10.1
21.6.68	2.4	2.0	11.0	3.6	14.1
11.7.68	1.8	2.8	9.9	4.9	10.8
AREA 3					
24.5.68	2.2	2.2	8.9	5.3	40.4
7.6.68	2.2	4.5	18.9	7.3	27.6
21.6.68	3.6	4.6	11.4	24.8	59.1
11.7.68	1.8	0.9	7.8	3.3	18.1
AREA 4					
24.5.68	1.3	1.9	5.8	5.1	29.2
7.6.68	1.8	1.6	3.5	7.1	30.3
21.6.68					
11.7.68	1.0	2.3	5.4	9.1	20.5
AREA 5					
24.5.68	1.8	0.7	9.0	4.6	12.8
7.6.68	1.3	1.8	10.2	6.6	11.5
21.6.68	2.8	3.4	8.4	8.2	44.3
11.7.68	2.2	2.5	6.4	7.4	31.0
5.8.68	2.0	2.0	8.4	12.7	29.4
AREA 7					
24.5.68	1.1	8.1	15.5	13.3	24.8
7.6.68	0.9	2.2	6.2	7.0	10.8
21.6.68	1.2	2.0	13.8	9.3	8.9
11.7.68	1.1	1.1	5.5	3.9	11.7
5.8.68	1.6	1.3	10.2	4.2	21.1
AREA 8					
24.5.68	1.2	2.7	10.7	4.6	27.2
7.6.68	0.7	2.2	17.6	3.3	4.8
21.6.68	1.6	4.5	13.1	11.9	64.1
11.7.68	1.1	1.5	7.5	4.8	16.6
5.8.68	1.1	4.2	10.4	2.6	38.3

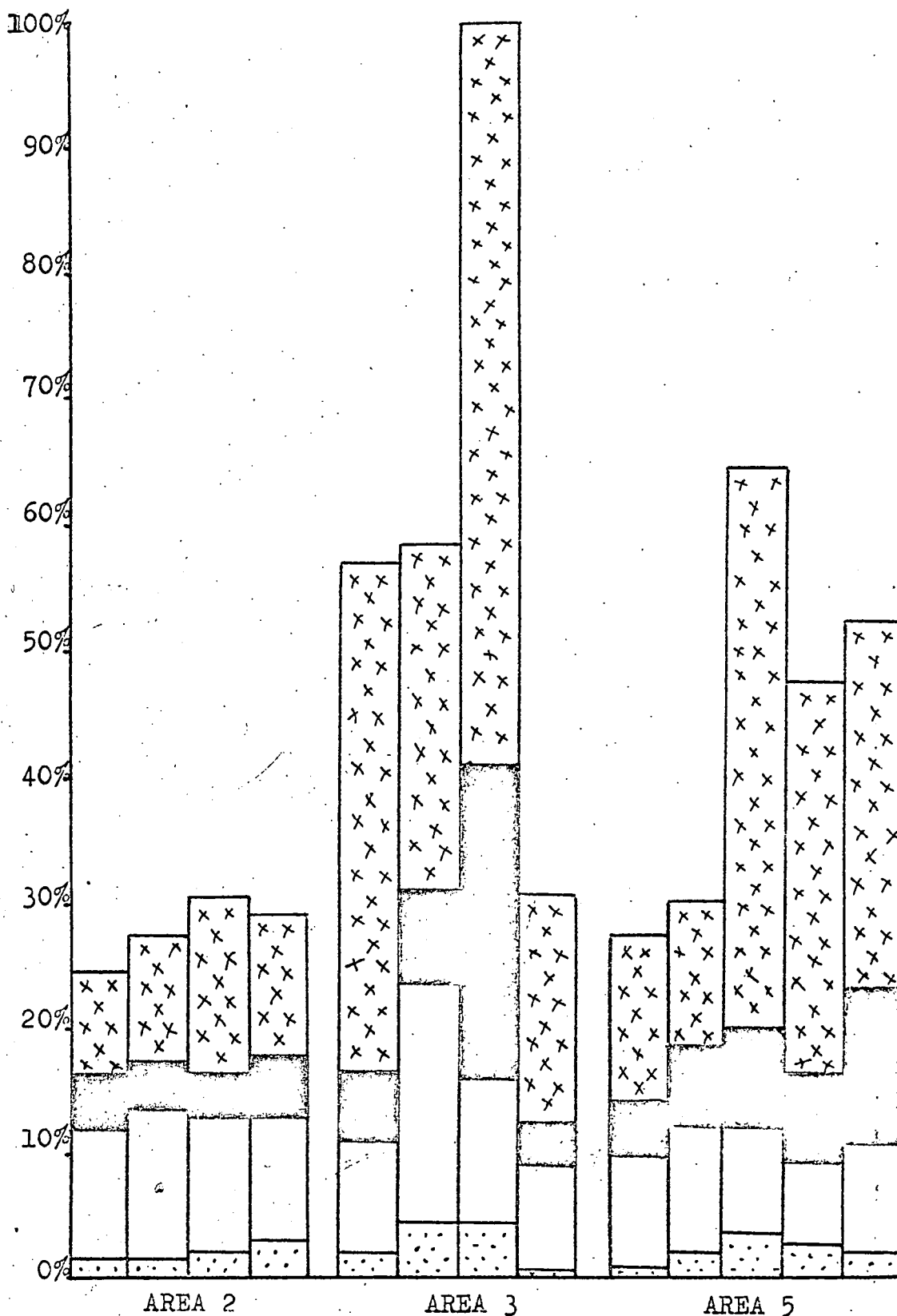
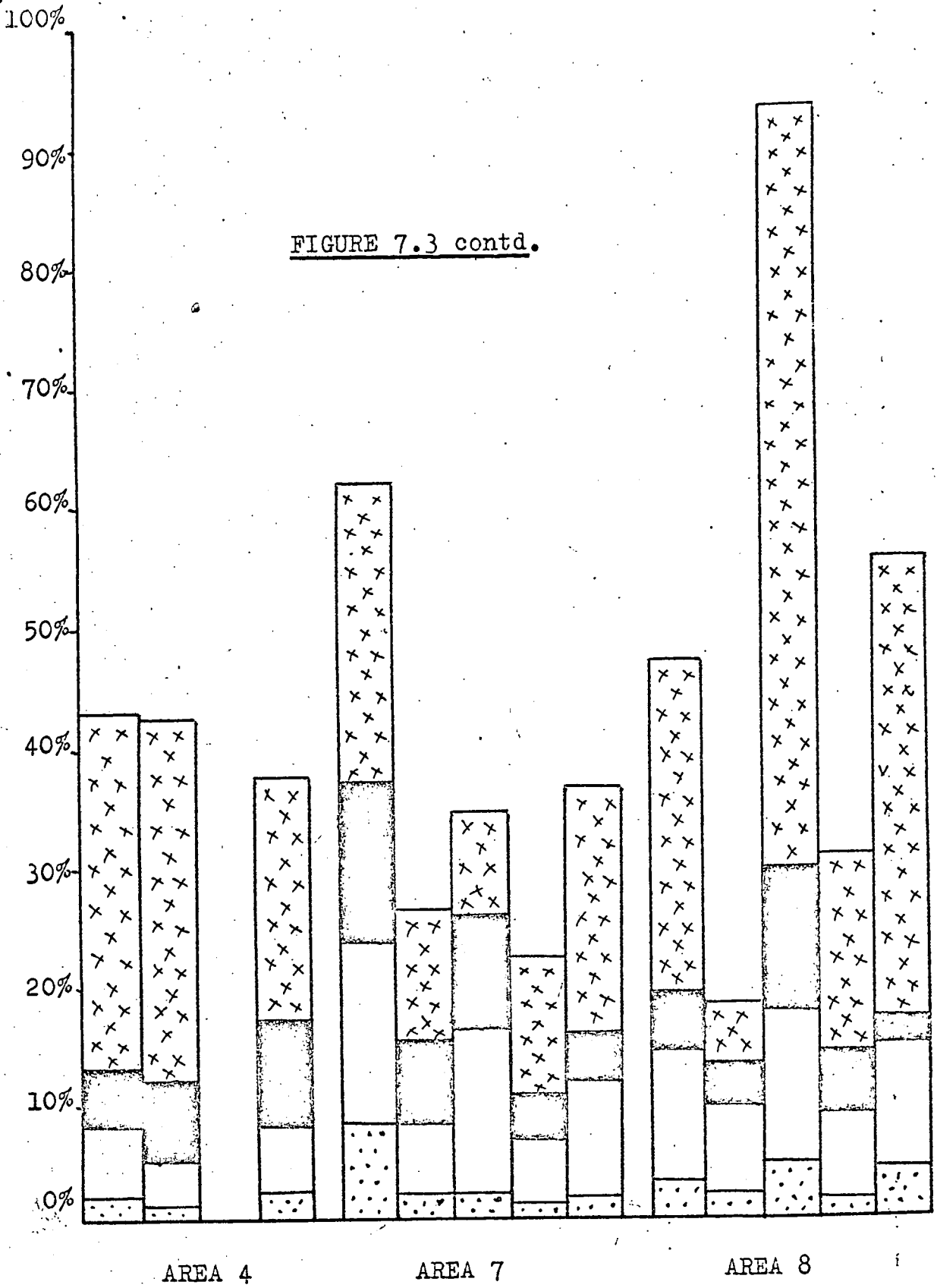

FIGURE 7.3 The amount of sodium, potassium, magnesium and calcium present in the plant debris—expressed as a percentage of the maximum total found. (see Table 7.3)

FIGURE 7.3 contd.



APPENDIX 8 Table 8.1

Ratios of Mineral Concentrations (mg per g dry weight) X 10 in the Whole community, Living and Dead Plant Material.

DATE & AREA	Whole community				Living community				Plant debris			
	Na	K	Mg	Ca	Na	K	Mg	Ca	Na	K	Mg	Ca
AREA 2												
24.5.68	<u>10</u>	116	20	35	<u>10</u>	134	17	29	<u>10</u>	71	31	56
7.6.68	<u>10</u>	67	12	22	<u>10</u>	70	10	16	<u>10</u>	68	23	58
21.6.68	<u>10</u>	82	16	34	<u>10</u>	82	<u>15</u>	29	<u>10</u>	55	18	71
11.7.68	<u>10</u>	54	10	16	<u>11</u>	60	<u>10</u>	14	<u>10</u>	36	18	40
AREA 3												
24.5.68	<u>10</u>	71	17	123	<u>10</u>	83	14	96	<u>10</u>	39	23	175
7.6.68	<u>10</u>	56	18	58	<u>10</u>	63	19	56	<u>10</u>	42	16	61
21.6.68	<u>10</u>	94	34	99	<u>10</u>	129	20	90	<u>10</u>	25	55	131
11.7.68	<u>10</u>	113	26	75	<u>10</u>	112	25	67	<u>10</u>	157	67	37
AREA 4												
24.5.68	<u>10</u>	100	26	125	<u>10</u>	143	25	92	<u>10</u>	32	27	155
7.6.68	<u>10</u>	106	38	142	<u>10</u>	177	33	111	<u>10</u>	21	38	182
21.6.68												
11.7.68	<u>10</u>	96	42	75	<u>10</u>	130	44	54	<u>10</u>	23	40	92
AREA 5												
24.5.68	<u>10</u>	72	28	48	<u>10</u>	127	48	71	<u>10</u>	122	62	174
7.6.68	<u>10</u>	83	28	71	<u>10</u>	87	25	70	<u>10</u>	55	35	63
21.6.68	<u>10</u>	37	26	49	<u>10</u>	33	22	25	<u>10</u>	25	24	128
11.7.68	<u>10</u>	34	16	46	<u>10</u>	34	15	37	<u>10</u>	24	28	117
5.8.68	<u>10</u>	46	28	39	<u>10</u>	45	23	28	<u>10</u>	40	60	138
AREA 7												
24.5.68	<u>10</u>	25	14	30	<u>10</u>	28	13	30	<u>10</u>	19	16	30
7.6.68	<u>10</u>	40	20	31	<u>10</u>	47	17	26	<u>10</u>	30	34	51
21.6.68	<u>10</u>	121	40	70	<u>10</u>	138	36	79	<u>10</u>	71	48	46
11.7.68	<u>10</u>	71	24	44	<u>10</u>	75	22	33	<u>10</u>	47	33	100
5.8.68	<u>10</u>	102	36	124	<u>10</u>	10	35	11	<u>10</u>	78	30	155
AREA 8												
24.5.68	<u>10</u>	69	19	93	<u>10</u>	96	20	86	<u>10</u>	40	17	101
7.6.68	<u>10</u>	84	16	30	<u>10</u>	91	18	38	<u>10</u>	76	15	20
21.6.68	<u>10</u>	59	28	15	<u>10</u>	88	28	151	<u>10</u>	27	25	136
11.7.68	<u>10</u>	65	30	86	<u>10</u>	64	25	73	<u>10</u>	54	34	120
5.8.68	<u>10</u>	42	15	82	<u>10</u>	55	21	80	<u>10</u>	42	<u>10</u>	152

APPENDIX 9

Comparison of the Standing Crop and Mineral Contents of Five Hay-Meadow Communities just prior to Mowing.

In order to compare the dry weight and mineral composition of ecosystems mown in different hay-meadows, two other fields were also sampled. Both fields are managed in a similar way to Cronkley hay-meadow. The additional samples were collected at the end of July 1968, these two fields being mown 15 days after Cronkley, and were compared with the last samples collected from areas 2 and 3.

Two samples were collected from Force Garth Pastures, and one from Widdybank Pasture. The vegetation at the former was species-rich and very tall. The first sample (F.G.1) here being taken near the bottom edge of the field. It would be expected that it received much drainage water and minerals from higher up the slope and here were found species-Campanula rotundifolia, Cardamine flexuosa and Arrhenatherum elatius-indicative of wetter pasture (Table 9.1). The second sample (F.G.2), was from higher up the slope. At F.G.1 were numerous "shoots" or "tillers" of the "lighter" grasses, such as Poa trivialis, Agrostis tenuis, Festuca rubra and Trisetum flavescens, while "robust" species-Holcus lanatus and Dactylis glomerata-were more common at F.G.2. Also the number of dicotyledons was less at F.G.2. The third site sampled, W.P., resembled in appearance area 2. At both Holcus lanatus, Poa trivialis, Agrostis tenuis, Festuca rubra, Cerastium holostæodes, Rumex acetosa, Ranunculus bulbosus and Trifolium repens were abundant. Trollius europæus, Veronica chamaedrys, Bellis perennis and Alchemilla glabra were present in the sample collected at W.P. but not from area 2

TABLE 9.11

NUMBER OF INDIVIDUALS PER SQ.M.

<u>SPECIES</u>	<u>F.G.1.</u>	<u>F.G.2.</u>	<u>W.P.</u>	<u>2</u>	<u>3</u>
<i>Anthoxanthum odoratum</i>	110		258	108	
<i>Holcus lanatus</i>	23	947	634	1309	338
<i>Poa trivialis</i>	971		1566	2208	1736
<i>Alopecurus pratensis</i>			39	706	805
<i>Agrostis tenuis</i>	1394	211	1863	965	
<i>Festuca rubra</i>	1848	759	3437	1316	6146
<i>Helictotrichon pubescens</i>	478	117	70		346
<i>Bromus mollis</i>				504	1242
<i>Poa pratensis</i>	94	8	227		
<i>Cynosaurus cristatus</i>		31	23		
<i>Dactylis glomerata</i>	250	626	219		
<i>Trisetum flavescens</i>	665	180	219		
<i>Arrhenatherum elatius</i>	211				
<i>Deschampsia caespitosa</i>		16			
<i>Luzula campestris</i>		8	31		
<i>Cerastium holostoides</i>	117	16	47	334	267
<i>Ranunculus bulbosus</i>	180	78	125	88	66
<i>Rumex acetosa</i>	70	24	86	136	142
<i>Conopodium majus</i>	47	16		191	90
<i>Trifolium repens</i>	16	63	78	257	
<i>Rhinanthus minor</i>	63			43	64
<i>Achillea millefolium</i>	16				34
<i>Cardamine flexuosa</i>	8				
<i>Campanula rotundifolia</i>	16				
<i>Leontodon autumnalis</i>			8		
<i>Plantago lanceolata</i>	391	31	117	39	
<i>Polygonum viviparum</i>		23			
<i>Leontodon hispidus</i>	16	8			
<i>Trollius europaeus</i>			16		
<i>Lathyrus pratensis</i>	117	86		31	7
<i>Veronica chamaedrys</i>	55	63	55		8
<i>Primula veris</i>	8				
<i>Geum rivale</i>	8				
<i>Vicia cracca</i>				2	
<i>Stellaria holostea</i>	133				
<i>Anemone nemorosa</i>					16
<i>Filipendula ulmaria</i>		23			
<i>Myosotis arvensis</i>					24
<i>Trifolium arvense</i>		8			
<i>Bellis perennis</i>		8	31		
<i>Alchemilla glabra</i>		8	8		
<i>Acrocladium cuspidatum</i>	+				
<i>Hylocomium splendens</i>	+				
<i>Lophocolea bidentata</i>	+				
<i>Mnium undulatum</i>	+	+			
<i>Calypogeia trichomanis</i>		+			
<i>Rhytidiadelphus squarrosus</i>		+			
<i>Brachythecium rutabulum</i>		+	+		
<i>Eurynchium swartzii</i>		+			

TABLE 9.2)

DRY WEIGHT PER PLANT.MCG. PER PLANT

<u>SPECIES</u>	<u>2</u>	<u>3</u>	<u>F.G.1.</u>	<u>F.G.2.</u>	<u>W.P.</u>
<i>Anthoxanthum odoratum</i>	35.9		24.7		45.1
<i>Holcus lanatus</i>	63.6	363.6	61.6	72.3	72.4
<i>Poa trivialis</i>	5.8	7.0	12.8		13.5
<i>Alopecurus pratensis</i>	54.8	193.9			196.5
<i>Agrostis tenuis</i>	26.1		82.4	61.8	32.2
<i>Festuca rubra</i>	6.9	12.6	11.7	13.2	13.3
<i>Bromus mollis</i>	22.6	13.5			
<i>Helictotrichon pubescens</i>		40.1	53.3	50.3	34.2
<i>Poa pratensis</i>	16.6		43.0	14.3	31.0
<i>Cynosurus cristatus</i>		91.3		44.3	112.9
<i>Dactylis glomerata</i>			103.2	314.8	170.1
<i>Trisetum flavescens</i>			72.8	129.5	15.9
<i>Arrhenatherum elatius</i>			76.5		
<i>Cerastium holostoides</i>	23.2	24.6	4.0	19.8	41.7
<i>Ranunculus bulbosus</i>	190.7	49.3		488.6	198.5
<i>Rumex acetosa</i>	133.3	28.8	571.1	133.7	125.8
<i>Conopodium majus</i>			301.2	343.2	
<i>Trifolium repens</i>	60.3		68.3	72.2	45.7
<i>Rhinanthus minor</i>	279.3	294.4	153.3		
<i>Achillea millefolium</i>			260.8		
<i>Plantago lanceolata</i>	172.4		39.1	517.1	202.6
<i>Lathyrus pratensis</i>	78.2	46.8	44.5	363.1	
<i>Leontodon hispidus</i>			261.3	482.2	
<i>Veronica chamaedrys</i>			66.6	62.9	26.5
<i>Stellaria holostea</i>			54.0		

TABLE 9.3

COMPARISON OF DRY WEIGHT AND NUMBERS OF CERTAIN SPECIES FROM DIFFERENT AREAS

SPECIES	Site	No per sqm.	Weight per plant mg.
HOLCUS LANATUS	2	1309	63.6
	3	338	363.6
	FG2	947	72.3
	WP	634	72.4
POA TRIVIALIS	2	2208	5.8
	3	1736	7.0
	FG1	971	12.8
	WP	1566	13.5
ALOPECURUS PRATENSIS	2	706	54.8
	3	805	193.9
	WP	39	196.5
AGROSTIS TENUIS	2	965	26.1
	FG1	1394	82.4
	FG2	211	61.8
	WP	1863	32.2
FESTUCA RUBRA	2	1316	6.9
	3	6164	12.6
	FG1	1848	11.7
	FG2	759	13.2
	WP	3437	13.3
HELICTOTRICHON PUBESCENS	3	346	40.1
	FG1	478	53.3
	FG2	117	50.3
	WP	70	34.2
DACTYLIS GLOMERATA	FG1	251	103.2
	FG2	626	314.8
	WP	219	170.1
RUMEX ACETOSA	2	136	133.3
	FG1	70	571.1
	FG2	24	133.7
	WP	86	125.8

TABLE 9.3 contd.

SPECIES	Site	No per sqm.	Weight per plant mg.
RHINANTHUS MINOR	2	143	279.3
	3	64	294.4
	FG1	63	153.3
PLANTAGO LANCEOLATA	FG1	391	39.1
	FG2	31	517.1
	WP	117	202.6
RANUNCULUS BULBOSUS	2	88	190.7
	3	66	49.3
	FG2	78	488.6
	WP	125	198.5
TRIFOLIUM REPENS	2	257	60.3
	FG2	63	72.2
	WP	78	45.7

here other herbaceous species were present. Area 3 being an open Festuca rubra turf did not resemble the three additional sites. Areas 2 and 3 seemed to have a greater number of individuals of each species, F.G.2 especially seemed to have fewer plants (Table 9.1)

The dry weight per plant of some species was similar in the different communities (Table 9.2), e.g. Holcus lanatus (area 2, F.G.2, L.P. & W.P.), other species e.g. Rumex acetosa (F.G.1), grew especially well or, e.g. Ranunculus bulbosus (area 3), poorly at a particular site. Dactylis glomerata showed a higher dry weight per plant where the numbers per m² were higher, while Plantago lanceolata was the opposite (Table 9.3).

At all sites, except area 3, the dry weight of the dead and dicotyledonous plant material each comprised 20% of the total dry weight of the community (Table 9.4).

TABLE 9.4

Dry Weight of Dicotyledons, Monocotyledons and Debris expressed as a Percentage of the Total Dry Weight of the Community

AREA	GRASSES	DICOTYLEDONS	MONOCOTYLEDONS
2	58.5	24.2	17.3
3	79.8	7.5	11.9
F.G.1	56.4	22.3	21.0
F.G.2	60.9	21.4	17.7
W.P.	62.5	18.6	18.7

F.G.2 had the highest standing crop (Table 9.5) due to the contributions of the "robust" species-Dactylis glomerata, Holcus lanatus and Ranunculus bulbosus- the two grasses together comprised 50% of the total community dry

TABLE 9.5

Total dry weight (g per m²) of each component group of plants at the 5 sites just before mowing.

AREA	2	3	F.G.1	F.G.2	W.P.
Grasses	203	408	275	321	246
Dicotyledons	84	38	109	113	73
Bryophytes	1	1	1	1	0.4
Debris	58	61	103	91	74
TOTAL (debris+ living plant material)	347	507	487	527	393
TOTAL (living plant material)	289	446	384	436	319

weight. 50% of the dry weight of the standing crop at F.G.1 consisted of Agrostis tenuis, Trisetum flavescens and Rumex acetosa. W.P. and area 2 were the least productive areas, Holcus lanatus, Agrostis tenuis, Festuca rubra, Dactylis glomerata, Plantago lanceolata and Ranunculus bulbosus formed 50% of the dry weight of the former site. The most important contributors at areas 2 and 3 were Alopecurus pratensis and Holcus lanatus, the latter forming 25% of the total at both. Festuca rubra was also important at area 3. The two most productive sites-or rather-the two sites with the highest standing crop at the sample time-F.G.2 and area 3-had no Anthoxanthum odoratum or Poa pratensis, little Agrostis tenuis and fewer dicotyledons (Table 9.6).

The results of analysing each species from F.G.1, F.G.2 and W.P. for sodium, potassium, magnesium and calcium are presented, with results of analysis of species from areas 2 and 3, in Table 9.7. In each section of the table the results have been expressed

TABLE 9.6

DRY WEIGHT AS PERCENTAGE OF TOTAL AT SAMPLE TIME

	2	3	FG1	FG2	WP
<i>Anthoxanthum odoratum</i>	1.2		0.5		3.0
<i>Holcus lanatus</i>	24.8	24.3		13.0	11.7
<i>Poa trivialis</i>	3.8	2.4	2.5		5.4
<i>Alopecurus pratensis</i>	14.1	30.8			2.0
<i>Agrostis tenuis</i>	7.5		23.5	2.5	15.3
<i>Festuca rubra</i>	2.7	15.3	4.4	1.9	11.6
<i>Bromus mollis</i>	3.4	3.3			
<i>Helictotrichon pubescens</i>		2.7	5.2	1.1	0.6
<i>Poa pratensis</i>			0.8		1.8
<i>Cynosaurus cristatus</i>					0.7
<i>Dactylis glomerata</i>			5.3	37.3	9.5
<i>Trisetum flavescens</i>			9.9	4.4	0.9
<i>Arrhenatherum elatius</i>			3.3		
<i>Cerastium holostæodes</i>	2.3	1.3			
<i>Ranunculus bulbosus</i>	5.0	0.6		7.3	6.3
<i>Rumex acetosa</i>	5.4	0.8	8.2	1.0	2.7
<i>Conopodium majus</i>			2.9	1.0	
<i>Trifolium repens</i>	4.6			0.8	0.9
<i>Rhinanthus minor</i>	3.6	3.7	2.0		
<i>Achillea millefolium</i>			0.8		
<i>Plantago lanceolata</i>			3.1	3.1	6.0
<i>Lathyrus pratensis</i>			1.1	5.9	
<i>Leontodon hispidus</i>			0.8	0.7	
<i>Veronica chamaedrys</i>				0.7	
<i>Stellaria holostea</i>			1.5		
Others	7.3	2.7	1.7	1.8	2.8
Debris	17.3	11.9	21.0	17.3	18.7

Mineral Content (mg per g dry weight of plant material) of each species.

Species	F.G.1			F.G.2			W.P.			AREA 2			AREA 3									
	Na	K	Mg	Na	K	Mg	Na	K	Mg	Na	K	Mg	Ca	Na	K	Mg	Ca					
Anthoxanthum odoratum	4.5	9.5	2.6	15.2	1.7	14.7	1.6	2.0	1.3	1.3	24.7	5.1	8.7	3.1	18.3	1.8	2.2	2.5	17.0	2.6	6.9	
Holcus lanatus									2.8	25.9	6.6	9.5	3.1	18.3	1.8	2.2	2.5	17.0	2.6	6.9		
Poa trivialis	0.7	17.0	3.2	14.1	0.8	19.1	8.3	12.6	0.8	19.1	8.3	12.6	1.3	21.3	3.4	4.5	0.5	19.0	3.0	6.5		
Alopecurus pratensis					0.3	15.0	2.8	11.0	0.3	15.0	2.8	11.0	1.3	15.3	2.5	2.9	1.0	10.9	5.4	12.7		
Agrostis tenuis	3.3	7.2	2.4	8.9	1.5	16.6	2.4	2.2	1.4	1.4	20.2	5.2	6.4	1.8	14.7	2.0	2.1	0.4	20.2	1.9	3.9	
Festuca rubra	1.2	15.1	2.9	13.5	0.5	24.1	1.8	2.3	0.8	0.8	24.3	5.5	7.6	0.5	15.8	1.6	2.3	0.2	10.3	1.1	3.1	
Helictotrichon pubescens	0.7	17.0	3.4	11.5	0.6	22.6	1.9	2.8	1.2	1.2	23.2	2.2	7.8	2.4	8.7	2.3	2.7	1.2	5.0	2.2	4.8	
Bromus mollis																						
Poa pratensis	0.8	12.8	12.9	11.2	2.0	19.0	1.8	7.3	1.5	1.5	9.1	4.2	3.5									
Cynosurus cristatus																						
Dactylis glomerata	5.1	8.9	4.7	19.1	4.5	22.5	2.6	2.5	2.6	2.6	17.7	8.4	9.1									
Trisetum flavescens	0.8	6.4	2.9	11.3	0.3	6.4	1.5	1.7	0.4	0.4	9.1	2.0	9.1									
Arrhenatherum elatius	1.1	12.5	3.3	11.7																		
Cerastium holostoides																						
Ranunculus bulbosus					7.9	19.7	4.4	7.1	3.7	3.7	21.5	4.0	27.1	6.8	12.5	5.1	10.3	1.2	21.9	39.4	7.9	
Rumex acetosa	2.5	12.4	4.5	13.0	1.6	11.5	5.1	8.1	2.7	2.7	14.1	12.3	15.8	2.2	15.3	4.2	4.4	5.2	10.1	5.8	18.1	
Conopodium majus	2.5	2.1	3.5	24.3	1.0	10.5	2.8	10.0														
Trifolium repens					4.2	14.5	14.8	12.1	2.1	2.1	16.7	15.1	35.8	6.4	16.4	4.1	8.5	0.7	17.2	3.7	6.1	
Rhinanthus minor	3.2	17.3	4.4	19.9																		
Achillea millefolium	10.8	9.9	4.1	20.3										3.4	15.0	4.5	7.5	0.7	17.2	3.7	6.1	
Plantago lanceolata	6.6	4.1	3.8	17.2	7.4	12.1	2.5	5.4	8.2	8.2	15.1	10.3	25.2									
Lathyrus pratensis	0.7	8.5	4.9	18.2	0.3	13.6	4.9	7.8														
Veronica chamaedrys					1.0	16.5	4.6	7.0														
Leontodon hispidus	2.6	7.2	12.7	33.8	2.5	15.6	12.7	13.2														
Stellaria holostea	10.7	20.4	4.3	9.8																		
other species-mosses	3.8	4.6	5.5	49.0																		
other species-dic.	3.2	28.4	8.5	11.8	1.4	13.3	3.5	4.8	3.4	3.4	25.0	4.2	19.6									
other species-mono.	3.5	8.6	2.6	13.2																		
Debris	1.8	2.8	3.8	22.0	0.9	3.9	2.4	3.9	0.7	0.7	2.1	1.2	7.4	1.7	6.2	3.1	6.8	0.3	4.7	2.0	11.0	

SPECIES	F.G.1			F.G.2			W.P.			AREA 2			AREA 3									
	Na	K	Mg	Na	K	Mg	Na	K	Mg	Na	K	Mg	Ca	Na	K	Mg	Ca					
Anthoxanthum odoratum	12.1	25.6	7.0	41.0	116.5	1006.9	109.6	137.0	174.4	1188.8	302.9	436.0	101.8	255.5	1523.1	147.3	184.8	312.0	2092.1	313.3	847.7	
Poa trivialis	8.7	21.1	39.7	174.8	116.5	1006.9	109.6	137.0	174.4	1188.8	302.9	436.0	101.8	255.5	1523.1	147.3	184.8	312.0	2092.1	313.3	847.7	
Alopecurus pratensis	378.8	826.6	275.5	1021.7	19.7	217.5	31.4	28.8	84.0	1212.0	312.0	384.0	346.6	18.7	4.7	143.9	14.9	21.1	32.6	1562.7	149.8	300.3
Festuca rubra	25.9	326.2	62.6	291.6	5.0	241.0	18.0	23.0	36.5	1108.1	250.8	346.6	18.7	27.5	98.9	25.7	31.2	19.7	83.5	37.1	72.8	
Helictotrichon pubescens	17.8	433.5	86.7	293.2	3.5	133.3	11.2	16.5	2.9	55.9	5.3	18.7	27.5	98.9	25.7	31.2	19.7	83.5	37.1	72.8		
Bromus mollis	5.2	57.2	11.6	44.8	14.0	133.0	12.6	51.1	4.0	24.6	11.3	9.4	27.5	98.9	25.7	31.2	19.7	83.5	37.1	72.8		
Poa pratensis	132.1	230.5	121.7	494.7	887.4	4437.0	512.7	493.0	97.0	660.2	313.3	339.4	31.8	27.5	98.9	25.7	31.2	19.7	83.5	37.1	72.8	
Cynosurus cristatus	38.7	309.8	140.4	546.9	7.0	149.1	35.0	39.6	1.4	31.8	7.0	31.8	31.8	27.5	98.9	25.7	31.2	19.7	83.5	37.1	72.8	
Dactylis glomerata	17.8	202.5	53.5	189.5	302.6	754.5	168.5	271.9	92.1	535.3	99.6	674.8	114.6	114.6	209.5	85.1	172.6	16.9	32.9	18.8	55.3	
Trisetum flavescens	100.5	498.0	181.0	523.0	8.3	59.8	25.5	42.1	29.2	152.3	132.8	170.6	170.6	40.8	278.0	75.5	83.3	16.9	32.9	18.8	55.3	
Arrhenatherum elatius	35.5	29.8	49.6	344.0	5.4	54.7	15.1	54.0	29.2	152.3	132.8	170.6	170.6	40.8	278.0	75.5	83.3	16.9	32.9	18.8	55.3	
Cerastium holostoides	30.7	166.1	42.2	191.0	18.9	65.3	21.6	54.5	7.6	60.1	54.4	128.9	128.9	99.1	253.9	63.1	132.2	13.1	323.1	68.6	115.1	
Ranunculus bulbosus	131.6	62.7	58.1	263.2	119.9	196.0	40.5	87.5	195.2	359.4	245.1	599.8	599.8	40.7	180.8	54.4	89.9	13.1	323.1	68.6	115.1	
Rumex acetosa	3.6	44.2	25.5	94.6	9.4	925.7	153.4	244.1	195.2	359.4	245.1	599.8	599.8	40.7	180.8	54.4	89.9	13.1	323.1	68.6	115.1	
Conopodium majus	30.7	166.1	42.2	191.0	18.9	65.3	21.6	54.5	7.6	60.1	54.4	128.9	128.9	99.1	253.9	63.1	132.2	13.1	323.1	68.6	115.1	
Trifolium repens	10.7	29.5	52.1	138.6	3.9	64.4	17.9	27.3	3.9	64.4	17.9	27.3	27.3	9.5	59.3	48.3	50.2	9.5	59.3	48.3	50.2	
Rhinanthus minor	5.0	146.9	31.0	70.6	9.5	59.3	48.3	50.2	9.5	59.3	48.3	50.2	50.2	9.5	59.3	48.3	50.2	9.5	59.3	48.3	50.2	
Plantago lanceolata	3.4	4.1	4.9	44.1	13.0	123.7	32.6	44.6	37.9	277.3	45.1	220.4	220.4	131.8	460.5	112.0	170.1	21.6	218.9	61.9	232.0	
Lathyrus pratensis	10.7	29.5	52.1	138.6	3.9	64.4	17.9	27.3	3.9	64.4	17.9	27.3	27.3	9.5	59.3	48.3	50.2	9.5	59.3	48.3	50.2	
Veronica chamaedrys	5.0	146.9	31.0	70.6	9.5	59.3	48.3	50.2	9.5	59.3	48.3	50.2	50.2	9.5	59.3	48.3	50.2	9.5	59.3	48.3	50.2	
Leontodon hispidus	29.8	264.1	79.1	109.7	13.0	123.7	32.6	44.6	37.9	277.3	45.1	220.4	220.4	131.8	460.5	112.0	170.1	21.6	218.9	61.9	232.0	
Stellaria holostea	10.8	26.7	8.1	40.9	13.0	123.7	32.6	44.6	37.9	277.3	45.1	220.4	220.4	131.8	460.5	112.0	170.1	21.6	218.9	61.9	232.0	
other species-mosses	184.7	287.3	389.9	225.7	82.3	356.5	219.4	356.5	51	154	88	543	543	101.1	361.0	179.9	396.1	32.1	268.2	119.8	663.8	
other species-dic.	1226	4295	1737	5190	1612	8347	1462	1871	862	6763	2139	4407	4407	938	5040	971	1527	591	6818	1553	4434	
other species-mono.	44.3	40.6	16.8	83.2	82.3	356.5	219.4	356.5	51	154	88	543	543	101.1	361.0	179.9	396.1	32.1	268.2	119.8	663.8	
Debris	184.7	287.3	389.9	225.7	82.3	356.5	219.4	356.5	51	154	88	543	543	101.1	361.0	179.9	396.1	32.1	268.2	119.8	663.8	
TOTAL	1226	4295	1737	5190	1612	8347	1462	1871	862	6763	2139	4407	4407	938	5040	971	1527	591	6818	1553	4434	
Achillea millefolium	44.3	40.6	16.8	83.2	82.3	356.5	219.4	356.5	51	154	88	543	543	101.1	361.0	179.9	396.1	32.1	268.2	119.8	663.8	

The Percentage of the Total of each Mineral in the Community that is Contained in each Species.

Species	F.G.1				F.G.2				W.P.				AREA 2				AREA 3			
	Na	K	Mg	Ca	Na	K	Mg	Ca	Na	K	Mg	Ca	Na	K	Mg	Ca	Na	K	Mg	Ca
Anthoxanthum odoratum	1.0	0.6	0.4	0.8	7.2	12.0	7.5	7.3	1.8	4.3	2.8	2.3	27.2	30.2	15.1	12.1	52.7	30.6	20.2	19.1
Holcus lanatus									2.0	6.0	8.2	6.0	1.8	4.9	4.5	3.7	1.1	3.4	2.3	1.8
Poa trivialis	0.7	0.5	2.3	3.4					0.3	1.7	1.0	1.9	6.5	18.1	12.2	8.9	21.2	24.9	45.7	44.7
Alopecurus pratensis									9.7	17.9	14.6	8.7	4.7	7.3	5.3	3.4				
Agrostis tenuis	30.9	19.2	15.9	19.6	1.2	2.6	2.1	1.5	4.2	16.3	11.7	7.9	0.5	2.0	1.5	1.4	5.5	22.9	9.6	6.8
Festuca rubra	2.1	7.6	3.6	5.6	0.3	2.9	1.2	1.2	0.3	0.8	0.2	0.4					0.4	2.1	0.1	1.0
Helictotrichon pubescens	1.4	10.1	5.0	5.6	0.2	1.6	0.8	0.9												
Bromus mollis													2.9	2.0	2.6	2.0	3.3	1.2	2.4	1.8
Poa pratensis	0.3	1.2	0.7	0.9					1.6	2.0	0.6	1.2								
Cynosurus cristatus									0.5	0.4	0.5	0.2								
Dactylis glomerata	10.8	5.4	7.0	9.5	55.0	53.1	35.1	26.3	11.2	9.8	14.6	7.7								
Trisetum flavescens	3.2	7.2	8.1	10.5	0.4	1.8	2.4	2.1	0.2	0.5	0.3	0.7								
Arrhenatherum elatius	1.4	4.7	3.1	3.6																
Cerastium holostoides																				
Ranunculus bulbosus					18.8	9.0	11.5	14.5	10.7	7.9	4.7	15.3	12.2	4.2	8.8	11.3	1.4	2.1	1.4	1.2
Rumex acetosa	8.2	11.6	10.4	10.1	0.5	0.7	1.8	2.2	3.4	2.3	6.2	3.9	4.3	5.5	7.8	5.5	2.8	0.5	0.1	1.3
Conopodium majus	2.9	6.9	2.9	6.6	0.3	0.7	1.0	2.9												
Trifolium repens					1.2	0.8	1.5	2.9	0.9	0.9	2.5	2.9	10.6	5.0	6.5	8.6				
Rhinanthus minor	2.5	3.9	2.4	3.7									4.3	3.6	5.6	5.9	2.2	4.7	4.4	2.6
Achillea millefolium	3.6	0.9	1.0	1.6																
Plantago lanceolata	10.7	1.5	3.3	5.1	7.4	2.3	2.8	4.7	22.6	5.3	11.5	13.6								
Lathyrus pratensis	0.3	1.0	1.5	1.8	0.6	5.1	10.5	13.0												
Veronica chamaedrys					0.2	0.8	1.2	1.5												
Leontodon hispidus	0.9	0.7	3.0	2.7	0.6	0.7	3.3	2.7												
Stellaria holostea	0.4	3.4	1.8	1.4																
other species-mosses	0.3	0.1	0.3	0.8																
other species-dic.	2.4	6.1	4.5	2.1	0.8	1.5	2.2	2.4	4.4	4.1	2.2	5.0	14.0	9.1	11.5	11.1	3.6	3.2	4.0	5.2
other species-mono.	0.9	0.6	0.5	0.8																
Debris	15.1	6.7	22.4	4.3	5.1	4.3	15.0	19.1	6.0	2.3	4.1	12.3	10.7	7.2	18.5	25.9	5.4	4.2	7.7	15.0

TABLE 9.7(e)

Total Mineral "Concentration" (mg per g dry weight)
of each Species

<u>Species</u>	FG.1	FG.2	W.P.	2	3
<i>Anthoxanthum odoratum</i>	31.8		39.8		
<i>Holcus lanatus</i>		20.0	45.8	25.4	29.0
<i>Poa trivialis</i>	35.0		40.8	30.5	29.0
<i>Poa pratensis</i>	27.7		30.1	22.0	25.0
<i>Agrostis tenuis</i>	21.8	22.7	33.2	20.6	
<i>Festuca rubra</i>	32.7	28.7	38.2	20.2	25.4
<i>Helictotrichon pubescens</i>	32.6	27.9	34.5		14.7
<i>Bromus mollis</i>				16.1	13.2
<i>Alopecurus pratensis</i>			29.1	22.0	19.0
<i>Cynosurus cristatus</i>			18.3		
<i>Dactylis glomerata</i>	37.8	32.1	37.8		
<i>Trisetum flavescens</i>	21.4	9.9	20.6		
<i>Arrhenatherum elatius</i>	28.6				
<i>Cerastium holostoides</i>					34.4
<i>Ranunculus bulbosus</i>		39.1	56.3	34.7	39.2
<i>Rumex acetosa</i>	32.4	26.3	44.9	26.1	
<i>Conopodium majus</i>	32.4	24.3			
<i>Trifolium repens</i>		35.6	69.7	35.4	
<i>Rhinanthus minor</i>	44.8			20.4	27.7
<i>Achillea millefolium</i>	45.1				
<i>Plantago lanceolata</i>	25.7	27.4	58.8		
<i>Lathyrus pratensis</i>	32.3	26.6			
<i>Veronica chamaedrys</i>		29.1			
<i>Leontodon hispidus</i>	56.3	44.0			
<i>Stellaria holostea</i>	35.2				
other species-mosses	62.9				
other species-dic.	51.9				
other species-mono.	27.9				
Debris	30.4	11.1	11.4	17.8	18.0

in a different way:-

- (a) mg per g dry weight of plant material,
- (b) mg per plant X 100,
- (c) mg per m² per species, and
- (d) percentage of each mineral found in the total plant material that is present in each species and
- (e) total mineral concentration (mg per g dry weight) in each species.

Table 9.8 shows the total amount (mg per m²), and Table 9.9 the percentage, of each mineral in

- (a) the whole community,
- (b) the living plant material, and
- (c) the dead plant material.

TABLE 9.8

Total Amount of each Mineral in the Whole Community, the Living Plant Material and the Dead Plant Material.

AREA	Whole Community				Living Plant Material			
	Na	K	Mg	Ca	Na	K	Mg	Ca
2	938	5040	971	1527	837	4679	791	1131
3	591	6818	1553	4454	559	6532	1433	3790
F.G.1	1226	4295	1737	5190	1041	4008	1347	4964
F.G.2	1612	8347	1462	1871	1530	7990	1243	1515
W.P.	862	6763	2139	4407	811	6609	2051	3864

AREA	Dead Plant Material			
	Na	K	Mg	Ca
2	101	361	180	396
3	32	286	120	664
F.G.1	185	287	390	226
F.G.2	82	357	219	356
W.P.	51	154	88	543

TABLE 9.9

Percentage of each Mineral Found in the
Living and Dead Plant Material.

AREA	Living Plant Material				Dead Plant Material			
	Na	K	Mg	Ca	Na	K	Mg	Ca
2	89.3	92.8	81.5	74.1	10.1	7.2	18.5	25.9
3	94.6	95.8	92.3	85.0	5.4	4.2	7.7	15.0
F.G.1	84.9	93.3	77.6	95.7	15.1	6.7	22.4	4.3
F.G.2	94.9	95.7	85.0	80.9	5.1	4.3	15.0	19.1
W.P.	94.0	97.7	95.9	87.7	6.0	2.3	4.1	12.3

Table 9.10 with the total weight of the four minerals studied shows that the ecosystem at W.P. contained the highest total of minerals even though (see Table 9.5) the total standing crop was low. Area 3, F.G.1

TABLE 9.10

The Total Weight of Minerals in the Living
Whole Community, the Living Plant
Material and the Dead Plant Material(mg/m²).

AREA	Whole Community	Living Plant Material	Debris
2	8476	7438	1038
3	13415	12314	1102
F.G.1	12448	11360	1088
F.G.2	13292	12278	1014
W.P.	14171	13335	836

and F.G.2 had similar total dry weight and total mineral content while the community at area 2 had the lowest values for both quantities.

Table 9.11 shows that the "concentration" of the four minerals in the living plant material was highest at areas 2 and 3, and that except for W.P., the "concentration" of all four minerals in the whole community

community and in the dead plant material were approximately the same. The higher total amount of minerals

TABLE 9.11

"Concentration" of the Total of the Four Minerals (mg per g dry weight) in the Whole Community, the Living Plant Material and the Dead Plant Material.

AREA	Whole Community	Living Plant Material	Debris
2	24.4	17.5	25.8
3	26.4	18.0	27.6
F.G.1	25.5	10.6	29.5
F.G.2	25.2	11.1	28.1
W.P.	36.0	10.0	41.8

present in the plant material was due to the higher mineral content of the individual species at W.P., as neither number per square metre nor dry weight per plant were greater there (Table 9.12 and Table 9.2).

TABLE 9.12

COMPARISON OF MINERAL CONTENT OF CERTAIN SPECIES FROM DIFFERENT SITES

SPECIES	Mineral mgn per gm dry weight					Total mineral mgn/gm
	Site	Na.	K.	Mg.	Ca.	
HOLCUS LANATUS	2	3.1	18.3	1.8	2.2	25.4
	3	2.5	17.0	2.6	6.9	29.0
	FG2	1.7	14.7	1.6	2.0	20.0
	WP	3.8	25.9	6.6	9.5	45.8
POA TRIVIALIS	2	1.3	21.3	3.4	4.5	30.5
	3	0.5	19.0	3.0	6.5	29.0
	FG1	0.7	17.0	3.2	14.1	35.0
	WP	0.8	19.1	8.3	12.6	40.8
ALOPECURUS PRATENSIS	2	11.3	19.3	2.5	2.9	26.0
	3	1.0	10.9	5.4	12.7	10.0
	W.P	0.3	15.0	2.8	11.0	29.1
AGROSTIS TENUIS	2	1.8	14.7	2.0	2.1	20.6
	FG1	3.3	7.2	2.4	18.9	21.8
	FG2	1.5	16.6	2.4	2.2	22.7
	WP	1.4	20.2	5.2	6.4	33.2
FESTUCA RUBRA	2	0.5	15.8	1.6	2.3	20.2
	3	0.4	20.2	1.9	3.9	26.4
	FG1	1.2	15.1	2.9	13.5	32.7
	FG2	0.5	24.1	1.8	2.3	28.7
	WP	0.8	24.3	5.5	7.6	38.2
HELICTOTRICHON PUBESCENS	3	0.2	10.3	1.1	3.1	14.7
	FG1	0.7	17.0	3.4	11.5	32.6
	FG2	0.6	22.6	1.9	2.8	27.9
	WP	1.2	23.3	2.2	7.8	34.5
DACTYLIS GLOMERATA	Fg1	5.1	8.9	4.7	19.1	37.8
	FG2	4.5	22.5	2.6	2.5	32.1
	WP	2.6	17.7	8.4	9.1	37.8
RUMEX ACETOSA	2	2.2	15.3	4.2	4.6	26.3
	FG1	2.5	12.4	4.5	13.0	32.5
	FG2	1.6	11.5	5.1	8.1	26.3
	WP	2.7	14.1	12.3	15.8	44.9

TABLE 9.12 contd.

SPECIES	Site	Na.	K.	Mg.	Ca.	Total mineral mgm/gm
RHINANTHUS MINOER	2	3.4	15.0	4.5	7.5	30.4
	3	0.7	17.2	3.7	6.1	27.7
	FG1	3.2	17.3	4.4	19.9	44.8
PLANTAGO LANCEOLATA	FG1	8.6	4.1	3.8	17.2	25.7
	FG2	7.4	12.1	2.5	5.4	27.4
	WP	8.2	15.1	10.3	25.2	58.8
RANUNCULUS BULBOSUS	2	6.8	12.5	5.1	10.3	34.7
	3	5.2	10.1	5.8	18.1	39.2
	FG2	7.9	19.7	4.4	7.1	39.1
	WP	3.7	21.5	4.0	27.1	56.3
TRIFOLIUM REPENS	2	6.4	16.4	4.1	8.5	35.4
	FG2	4.2	14.5	4.8	12.1	35.6
	WP	2.1	16.7	15.1	35.8	69.7

FIGURE 10.1

MAP OF EXPERIMENTAL AREA

(FROM O. S. SHEET NY 82 NE.)

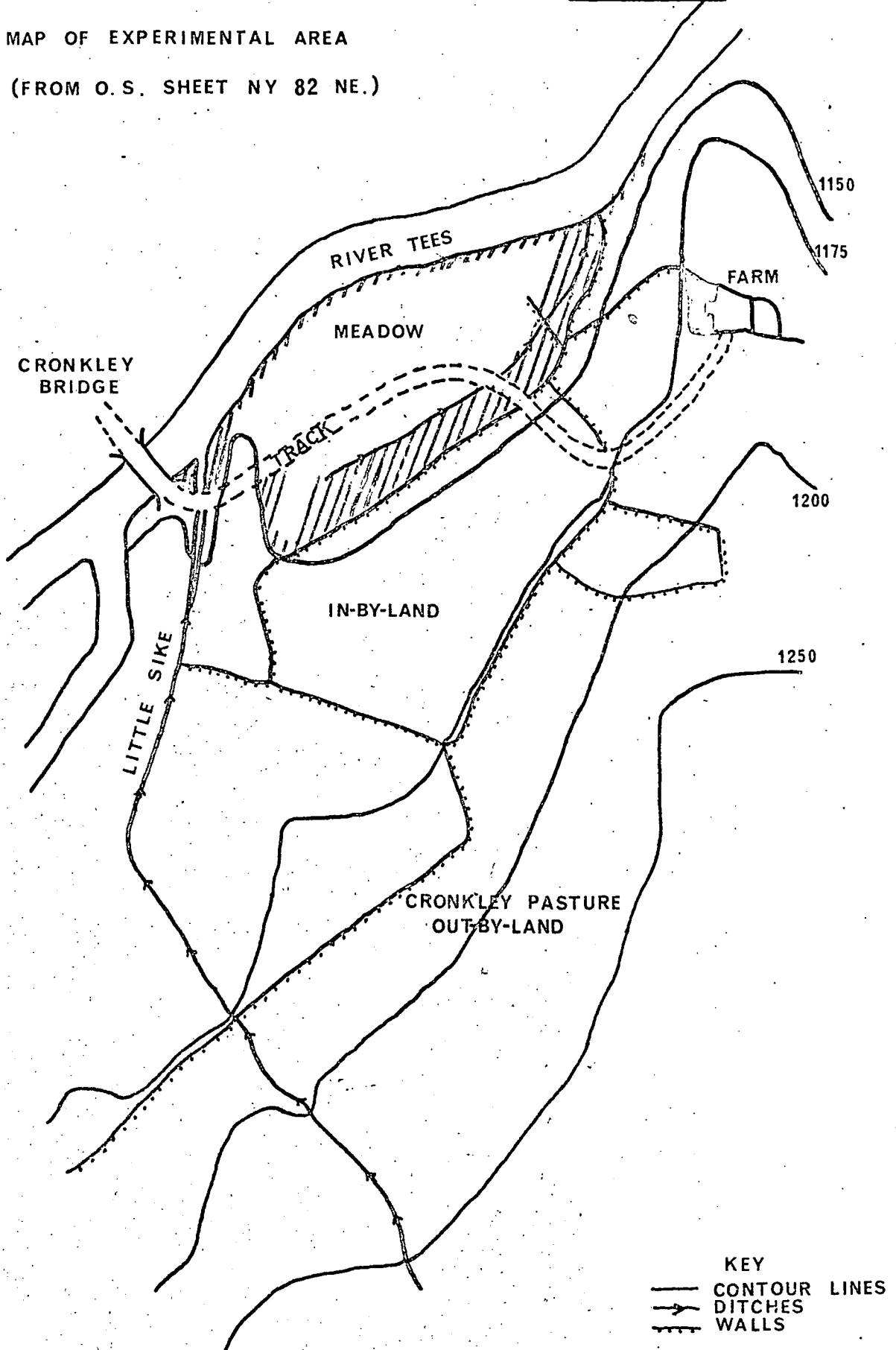

Figure to show position of quadrats—all recorded in the shaded area.

KEY TO FIGURE 10.2

- 1.....*Molinia caerulea*
- 2.....*Achillea ptarmica*
- 3.....*Cynosurus cristatus*
- 4.....*Euphrasia* sp.
- 5.....*Eriophorum angustifolium*
- 6.....*Carex panicea*
- 7.....*Anemone nemorosa*
- 8.....*Lychnis flos-cuculi*
- 9.....*Helictotrichon pratensis*
- 10.....*Juncus bulbosus*
- 11.....*Conopodium majus*
- 12.....*Plantago lanceolata*
- 13.....*Cirsium palustre*
- 14.....*Festuca rubra*
- 15.....*Ranunculus acris*
- 16.....*Succisa pratensis*
- 17.....*Juncus squarrosus*
- 18.....*Trifolium pratense*
- 19.....*Brachythecium rutabulum*
- 20.....*Mnium hornum*
- 21.....*Galium cruciata*

137 Quadrats

FIGURE 10.2

Normal
Association Hierarchy
Diagram.

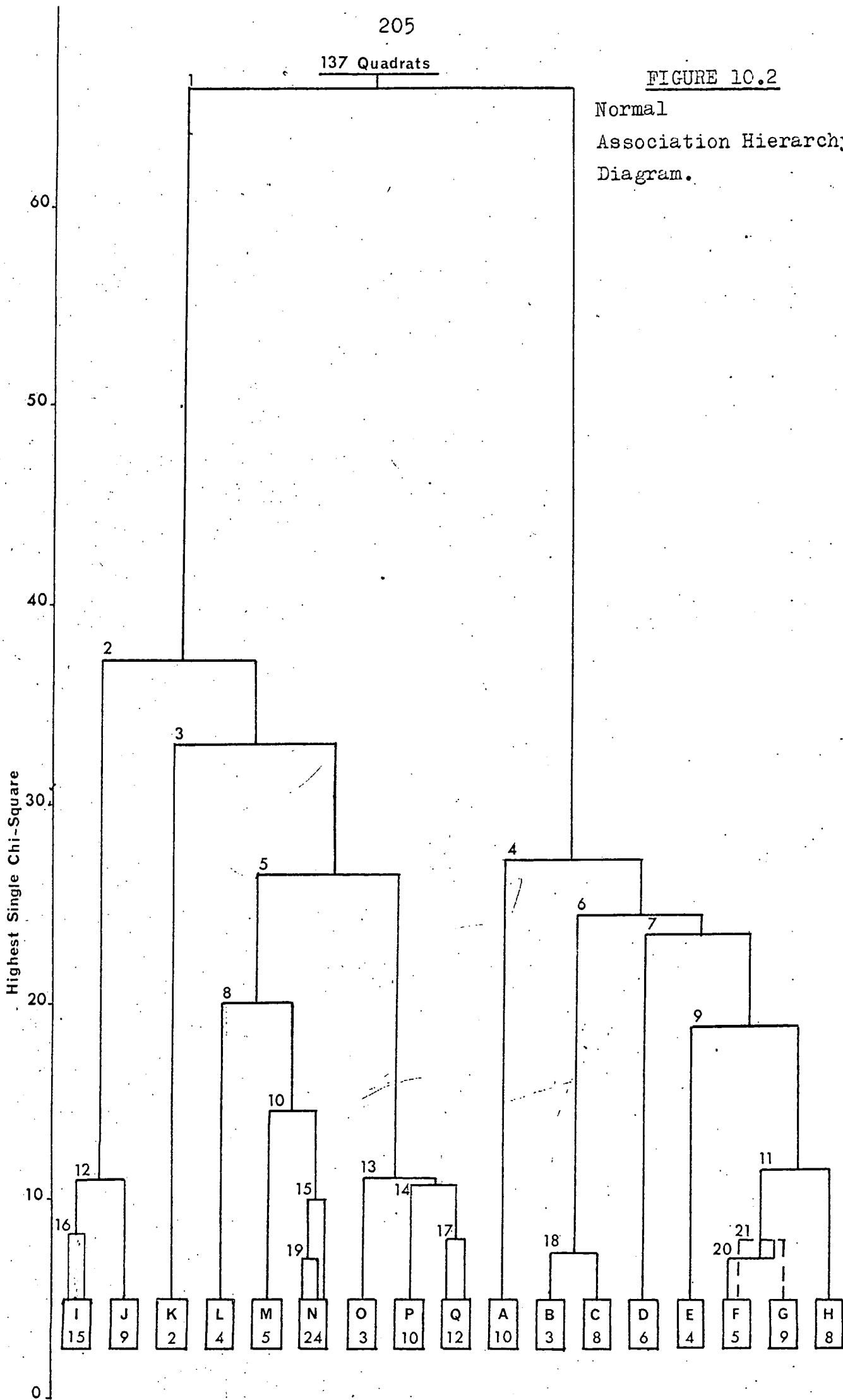

TABLE 10.1

Percentage Frequency of Occurrence of each species in the Quadrat Groups.

Group.	A	B	D	E	F	G	H	J	I	C	K	L	M	N	O	P	Q
Average number of Phanerogam species.	33	29	22	24	22	10	21	22	30	25	30	30	20	19	25	17	12
Average number of cryptogam species.	5	8	4	2	2	+	2	3	6	5	7	4	6	4	4	3	5
Number of stands in group.	10	3	6	4	5	9	8	9	15	8	2	4	5	24	3	10	12
Phanerogam cover %	85	90	98	100	95	95	100	92	98	95	100	99	85	95	98	98	90
Cryptogam cover %	10	25	2-40	+	6-10	+	0-30	0-50	2-50	0-60	30	2-20	50	2-50	20-70	5	2-70
Height of vegetation cm.	5-10	25-40	15-40	20-30	10-25	20-50	30-60	20-70	15-60	20-60	15-45	15-45	20-50	10-50	15	20-50	
Site of quadrat	R.B.	Bk.	Bk.	R.B.	R.B.	Bk.	Bk.	Bg.	Bg.	Bg.	Bg.	Bg.	Bg.8	Bg.	Bg.	Bg.	Bg.
Amount of litter.	VI-L ^o	P-S	M-P	VL	O-M	VI-P-M	VI-L	M-P	S-M	VL-M	L-S	M	M-P	M	M	L-M	M-P
Slope.	F-10 ^o	30-60 ^o	F-40 ^o	F-15 ^o	F-10 ^o	F-30 ^o	F-20 ^o	F-30 ^o	F-20 ^o	F-5 ^o	F-5 ^o	F-5 ^o	F	F-10 ^o	F	F-15 ^o	F-5 ^o
Association character and differential species.																	
<i>Molinia caerulea</i>	90.0	100.0	50.0	75.0			25.0	100.0	100.0	87.5	100.0	100.0	100.0	100.0	100.0	100.0	100.0
<i>Rhinanthus minor</i>	100.0	100.0		75.0	100.0	22.2		22.2	46.7	50.0	50.0	25.0					
<i>Centaurea nigra</i>	60.0	66.7	83.3	25.0	20.0	22.2		22.2	20.0	50.0	50.0	25.0				20.0	
<i>Agrostis tenuis</i>	40.0	66.7		25.0	20.0	22.2	25.0	20.0	40.0	25.0	100.0						
<i>Alchemilla glabra</i>	90.0	66.7		100.0				26.7									
<i>Leontodon hispidus</i>	70.0	33.3		75.0	20.0			44.4	46.7				20.0				
<i>Campanula rotundifolia</i>		33.3		25.0	80.0	44.4			26.7								
<i>Trollius europaeus</i>		33.3		50.0	100.0	100.0											
<i>Holcus mollis</i>		33.3		25.0	25.0	25.0											
<i>Carex caryophyllea</i>	20.0			25.0	25.0												
<i>Conopodium majus</i>	30.0	33.3		50.0	100.0	100.0										30.0	
<i>Euphrasia</i> sp.	100.0											25.0					
<i>Galium cruciata</i>	70.0			25.0	60.0												
<i>Helictotrichon pratensis</i>	70.0			100.0													
<i>Plantago maritima</i>	80.0			25.0	20.0												
<i>Festuca ovina</i>	20.0							33.3				75.0	80.0	87.5	33.3	40.0	83.3
<i>Viola palustris</i>	40.0	33.3						33.3		25.0		50.0	100.0	62.5	100.0	20.0	

	A	B	D	E	F	G	H	J	I	C	K	L	M	N	O	P	Q
MOLINION Character species.																	
<i>Achillea ptarmica</i>	20.0	100.0	33.3	50.0	20.0	22.2	75.0	100.0	100.0	50.0							
<i>Juncus conglomeratus</i>					20.0		37.5	88.9	33.3	50.0			40.0	29.2	33.3	20.0	
<i>Festuca arundinacea</i>				50.0							50.0						

	A	B	D	E	F	G	H	J	I	C	K	L	M	N	O	P	Q
MOLINIETALIA Character species																	
<i>Succisa pratensis</i>	70.0	100.0	66.7	75.0			25.0	66.7	73.3	50.0	50.0	75.0	100.0	87.5	100.0	60.0	41.7
<i>Carex panicea</i>	40.0	100.0						33.3	93.3	100.0	100.0	100.0	100.0	91.7	66.7	30.0	33.3
<i>Deschampsia caespitosa</i>			66.7	50.0	60.0	55.6	50.0	66.7	60.0		50.0	25.0				30.0	
<i>Caltha palustris</i>				50.0	20.0		75.0	44.4	66.7	62.5	100.0	75.0	20.0		33.3		
<i>Equisetum palustre</i>	50.0	66.7		50.0	40.0		75.0	33.3	33.3	62.5		75.0	20.0	29.2		20.0	
<i>Filipendula ulmaria</i>	20.0	33.3		50.0	60.0	33.3	63.5	33.3	20.0	37.5	100.0						
<i>Sanguisorba officinalis</i>	70.0			100.0		22.2		33.3	33.3	25.0						30.0	
<i>Angelica sylvestris</i>		33.3		50.0	20.0	33.3	37.5	66.7	33.3		50.0				66.7		
<i>Cirsium palustre</i>					20.0			44.4	46.7	25.0	50.0				100.0		
<i>Lychnis flos-cuculi</i>								33.3	25.0	50.0	100.0				33.3		
<i>Geum rivulare</i>					20.0		25.0		25.0								

	A	B	D	E	F	G	H	J	I	C	K	L	M	N	O	P	Q
MOLINIO-ARRHENATHERETALIA Character species																	
<i>Anthoxanthum odoratum</i>	90.0	100.0	100.0	75.0	60.0	66.7	100.0	88.9	93.3	87.5	100.0	100.0	80.0	100.0	100.0	100.0	66.7
<i>Holcus lanatus</i>	90.0	100.0	100.0	100.0	100.0	77.8	100.0	100.0	100.0	87.5	100.0	100.0	40.0	75.0	100.0	80.0	41.7
<i>Festuca rubra</i>	60.0	100.0	83.3	50.0	100.0	55.6	75.0	88.9	87.5	100.0	75.0	20.0	33.3	33.3	66.7	100.0	
<i>Rumex acetosa</i>	20.0	100.0	100.0	75.0		100.0	87.5	77.8	60.0	50.0	100.0	75.0			100.0	70.0	33.3
<i>Ranunculus acris</i>	60.0	100.0	33.3	75.0	60.0	44.4	37.5	77.8	93.3	50.0	100.0	100.0	20.0	58.3	66.7	40.0	
<i>Plantago lanceolata</i>	80.0	100.0	100.0	100.0	20.0	22.2	37.5		100.0		50.0	50.0				30.0	
<i>Cerastium holostoides</i>	90.0	66.7	66.7	75.0	60.0	22.2	75.0	44.4	66.7	62.5	50.0	75.0	20.0	25.0	33.3		
<i>Cardamine pratensis</i>					40.0		62.5	33.3	46.7						66.7		
<i>Briza media</i>	90.0								66.7	25.0		50.0		25.0		20.0	
<i>Trifolium repens</i>	60.0	66.7	50.0			22.2			26.7	37.5	100.0						
<i>Cynosurus cristatus</i>	70.0	100.0	83.3	75.0			37.5		33.3	25.0	100.0						
<i>Taraxacum paludosum</i>	20.0	66.7	33.3	25.0				22.2	33.3	37.5	100.0	50.0			33.3		
<i>Ranunculus repens</i>						66.7	75.0	33.3	26.7	37.5	50.0				33.3		
<i>Poa trivialis</i>		33.3			20.0	44.4	50.0	44.4			50.0	50.0	20.0		33.3		
<i>Trifolium pratense</i>	70.0	100.0		75.0					26.7		50.0				33.3		

MOLINIO-ARRHENATHERETALIA Character species contd.

	A	B	D	E	F	G	H	J	I	C	K	L	M	N	O	P	Q
Dactylis glomerata	50.0		33.3	100.0	100.0		37.5										
Prunella vulgaris	20.0	66.7		25.0					60.0		100.0						
Lotus corniculatus	80.0	33.3	33.3	50.0													
Vicia cracca	60.0			25.0			25.0										
Poa pratensis				66.7		44.4									33.3		
Lathyrus pratensis	30.0				50.0												
Leontodon autumnalis									20.0	25.0		50.0					
Phleum pratense		33.3								25.0	50.0						
Lolium perenne									50.0								

Accompanying Species of the ARRHENATHERETALIA

Potentilla erecta	50.0	100.0	100.0	25.0	20.0	44.4	50.0	77.8	86.7	62.5	50.0	100.0	80.0	100.0	66.7	100.0	100.0
Agrostis gigantea	20.0		66.7		100.0	66.7	50.0	66.7	20.0	37.5		50.0	20.0			50.0	
Galium verum	50.0				20.0												
Carex flacca	60.0																
Achillea millefolium	40.0			25.0	40.0												
Trisetum flavescens	20.0		33.3	25.0													
Veronica chamaedrys		33.3															
Pimpinella saxifraga	30.0																
Galium palustre							25.0									20.0	
Listera ovata									20.0								
Parnassia palustris	20.0																
Gymnadenia conopsea									20.0								
Arrhenatherum elatius					20.0												

Other accompanying species.

Luzula campestris	20.0	66.7	100.0		25.0	25.0	44.4	93.3	62.5	100.0	100.0	100.0	100.0	79.2	66.7	60.0	58.3
Carex nigra		66.7	50.0		37.5	22.2	22.2	73.3	75.0	100.0	75.0	100.0	100.0	83.3	66.7	70.0	33.3
Agrostis canina				25.0	20.0		22.2	60.0	37.5	50.0	50.0	75.0	60.0	100.0	66.7	60.0	66.7
Juncus acutiflorus	20.0	33.3	33.3	25.0			37.5	77.8	66.7	50.0	100.0	100.0	60.0	62.5	100.0	70.0	25.0
Carex echinata							33.3	66.7	50.0			75.0	80.0	83.3		60.0	
Eriophorum angustifolium							33.3	53.3	37.5	50.0	50.0	100.0	100.0	100.0			
Nardus stricta	20.0						22.2	73.3	50.0	50.0	50.0	75.0	40.0	54.2		20.0	25.0

TABLE 10.1 contd.

	A	B	D	E	F	G	H	J	I	C	K	L	M	N	O	P	Q
Bryophytes and lichens contd.																	
Polytrichum commune																	
Plagiochila asplenoides									20.0								
Scapania undulata	30.0	33.3															
Eurhynchium swartzii		33.3															
Cladonia sp.		33.3														33.3	
Bryum pallelescens	20.0																
Fissidens sp.	20.0																
Philonotis fontana	20.0																
Rhytidiadelphus triquetrus									20.0								
Aulacomnium palustre													20.0				
Riccardia pinguis													20.0				

Amount of litter:-

- HL ...very little
- L ...little
- P ...patchy
- S ...medium
- M ...much
- O ...none

Site of quadrat:-

- R.B...river bank
- Bk...bank at foot of fell
- Bg...boggy areas.