

Durham E-Theses

An investigation into distribution parameters of steam turbine blade and wheel vibration measurements

Farid-Uddin, M.

How to cite:

Farid-Uddin, M. (1973) *An investigation into distribution parameters of steam turbine blade and wheel vibration measurements*, Durham theses, Durham University. Available at Durham E-Theses Online: <http://etheses.dur.ac.uk/10294/>

Use policy

The full-text may be used and/or reproduced, and given to third parties in any format or medium, without prior permission or charge, for personal research or study, educational, or not-for-profit purposes provided that:

- a full bibliographic reference is made to the original source
- a [link](#) is made to the metadata record in Durham E-Theses
- the full-text is not changed in any way

The full-text must not be sold in any format or medium without the formal permission of the copyright holders.

Please consult the [full Durham E-Theses policy](#) for further details.

AN INVESTIGATION INTO DISTRIBUTION PARAMETERS
OF STEAM TURBINE BLADE AND WHEEL VIBRATION MEASUREMENTS

M FARID-UDDIN

Thesis submitted for the degree of
Master of Science in the Faculty of
Science, University of Durham

1973



ABSTRACT

This investigation was carried out to find a concise and meaningful way of describing the steam turbine blade and wheel vibration measurements which would enable predictions from "experimental" to "production" wheels to be made with known level of confidence. A large volume of vibration measurements from many years of testing was available. For the purpose of this study it was decided to concentrate the analysis on stage six of low-pressure turbine wheels. Two types of wheels, similar in every respect except root fixation, were used.

The method of obtaining and interpreting static and dynamic blade and wheel vibration frequency measurements is described. Measurements from the wheels selected for study were analysed by appropriate statistical techniques to test assumptions and hypotheses derived from long-standing experience of empirical vibration tests.

It was found that statistical analysis yields results in line with engineering expectations. In specific instances relating to the use of "experimental" wheels in predicting the performance of "production" wheels the statistical analysis not only confirmed existing practice, but pointed towards a more precise foundation of the procedure of estimating dynamic frequencies for production wheels.

The suitability of the use of statistical techniques for analysis of problems of this kind is discussed.

ACKNOWLEDGMENTS

The work described in this thesis could not have been carried out without access to vibration measurement data relating to many years of testing in the Strain and Vibration Department of C.A. Parsons & Co. Ltd. I am grateful to Mr. L.E. Cave for giving me permission to use this information.

I should like to thank my supervisor, Dr. P. Gill, for his guidance and encouragement, and Dr. A. Hawkes for useful discussions about the statistical analysis.

Thanks also to my wife for her patience, which helped me to complete the task.

TABLE OF CONTENTS

		<u>Page</u>
CHAPTER I	Introduction	16
CHAPTER II	2.0 Review of previously published literature	21
	2.1 Empirical investigations	21
	2.2 Theoretical approach	35
	2.3 Techniques of measurement and instrumentation	38
	2.3.1 Use of gauges	39
	2.3.2 Holography	41
	2.3.3 Radio telemetry method	43
CHAPTER III	3.0 Machine "A" and Machine "B"	47
	3.1 Arch Coverband	47
	3.2 Machine "A" - Firtree root blades	48
	3.3 Machine "B" - Riveted root blades	48
	3.4 Stage Five	49
CHAPTER IV	4.0 Measurement and Interpretation of vibration frequencies	56
	4.1 Method	56
	4.1.1 Equipment	57
	4.1.2 Dynamic test set up	58
	4.2 Interpretation of vibration frequency measurements	59
	4.2.1 Static tests	59
	4.2.2. Dynamic tests	59
	4.3 Source of data	60
CHAPTER V	5.0 Distribution parameters of steam turbine blades and wheel vibration measurements	85
	5.1 Static blade vibration measurements	86
	5.2 Static wheel vibration measurements	90
	5.3 Stage Five wheel vibration measurements	94
CHAPTER VI	6.0 The use of experimental wheel measurements for predictive purposes.	105
	6.1 Experimental wheel	106
	6.2 Production wheels	108
	6.3 Dynamic measurements	111
	6.3.1 Estimating vibration frequencies at running speed for production wheels	115

TABLE OF CONTENTS (Continued)

	<u>Page</u>
CHAPTER VII	
Discussion and conclusions	124
Bibliography	171
List of Figures	6
List of Tables in Chapter V	10
List of Tables in Chapter VI	11
List of Tables in the Appendix	12
List of Symbols and Abbreviations	15
Appendix	140 to 170

	<u>LIST OF FIGURES</u>	<u>Page</u>
Fig. 1	660 MW 3000 rev/min Steam Turbine typical of machine "A" during erection on site.	50
Fig. 2	Bladed rotor for double-flow LP Turbine typical of machine "A". 660 MW output showing all six stages each way.	51
Fig. 3	Cross-section of experimental wheel for machine "A".	52
Fig. 4	Arch coverband blade assembly, typical of machine "A" (firtree root) low pressure sets.	53
Fig. 5	Cross-section of experimental wheel for machine "B".	54
Fig. 6	Arch coverband assembly, typical of machine "B" (riveted root) low pressure sets.	55
Fig. 7	Block diagram of apparatus for static and dynamic tests.	61
Fig. 8	Static wheel frequencies Vs. nodal diameter for experimental wheel of machine "A" (firtree root).	62
Fig. 9	Static wheel frequencies Vs. nodal diameter for experimental wheel of machine "B" (riveted root).	62
Fig. 10	Static wheel frequencies Vs. nodal diameter for machine "A" Set I (firtree root).	63
Fig. 11	Static wheel frequencies Vs. nodal diameter for machine "A" Set II (firtree root).	64

<u>LIST OF FIGURES (Contd)</u>		<u>Page</u>
Fig. 12	Static wheel frequencies Vs. nodal diameter for machine "A" Set III (firtree root).	65
Fig. 13	Static wheel frequencies Vs. nodal diameter for machine "B" Set I (riveted root).	66
Fig. 14	Static wheel frequencies Vs. nodal diameter for machine "B" Set II (riveted root).	67
Fig. 15	Static wheel frequencies Vs. nodal diameter for machine "B" Set III (riveted root).	68
Fig. 16	Static wheel frequencies Vs. nodal diameter for machine "B" Set IV (riveted root).	69
Fig. 17	Dynamic wheel frequency f^2 Vs. rotational speed R^2 for experimental wheel of machine "A", (firtree root) 0 - nodal diameters.	70
Fig. 18	Dynamic wheel frequency f^2 Vs. rotational speed R^2 for experimental wheel of machine "A" (firtree root) 1 - nodal diameter.	71
Fig. 19	Dynamic wheel frequency f^2 Vs. rotational speed R^2 for experimental wheel of machine "A" (firtree root) 2-nodal diameters.	72
Fig. 20	Dynamic wheel frequency f^2 Vs. rotational speed R^2 for experimental wheel of machine "A" (firtree root) 3-nodal diameters.	73
Fig. 21	Dynamic wheel frequency f^2 Vs. rotational speed R^2 for experimental wheel of machine "A" (firtree root) 4-nodal diameters.	74
Fig. 22	Dynamic wheel frequency f^2 Vs. rotation speed R^2 for experimental wheel of machine "A" (firtree root) 5-nodal diameters.	75

	<u>LIST OF FIGURES (Contd)</u>	<u>Page</u>
Fig. 23	Dynamic wheel frequency f^2 Vs. rotational speed R^2 for experimental wheel of machine "A" (firtree root) 6-nodal diameters.	76
Fig. 24	Main frequency f^2 of blade No. 19 of experimental wheel of machine "A" (firtree root) Vs. rotational speed R^2 .	77
Fig. 25	Main frequency f^2 of blade No. 20 of experimental wheel of machine "A" (firtree root) Vs. rotational speed R^2 .	78
Fig. 26	Main frequency f^2 of blade No. 27 of experimental wheel of machine "A" (firtree root) Vs. rotational speed R^2 .	79
Fig. 27	Main frequency f^2 of blade No. 62 of experimental wheel of machine "A" (firtree root) Vs. rotational speed R^2 .	80
Fig. 28	Main frequency f^2 of blade No. 64 of experimental wheel of machine "A" (firtree root) Vs. rotational speed R^2 .	81
Fig. 29	Main frequency f^2 of blade No. 76 of experimental wheel of machine "A" (firtree root) Vs. rotational speed R^2 .	82
Fig. 30	Chart showing sources of data for machine "A" (firtree root).	83
Fig. 31	Chart showing sources of data for machine "B" (riveted root).	84
Fig. 32	Frequency histograms of static main blade frequencies in Hz for experimental wheel.	131

LIST OF FIGURES (Contd)Page

	of machine "A" (firtree root)	
	i) Just before dynamic test	
	ii) Just after dynamic test	
	iii) Two weeks after dynamic test.	131
Fig. 33	Frequency histograms of static main blade frequencies in Hz of machine "A" Set I.	132
Fig. 34	Frequency histograms of static main blade frequencies in Hz of machine "A" Set II.	133
Fig. 35	Frequency histograms of static main blade frequencies in Hz of machine "A" of Set III.	134
Fig. 36	Frequency histograms of static main blade frequencies in Hz for experimental wheel of machine "B" (riveted root).	135
Fig. 37	Frequency histograms of static main blade frequencies in Hz of machine "B" Set I.	136
Fig. 38	Frequency histograms of static main blade frequencies in Hz of machine "B" Set II.	137
Fig. 39	Frequency histograms of static main blade frequencies in Hz of machine "B" Set III.	138
Fig. 40	Frequency histograms of static main blade frequencies in Hz of machine "B" Set IV.	139
Fig. 41	Dynamic test chamber.	169
Fig. 42	Erosion damaged blade.	170

LIST OF TABLES IN CHAPTER VPage

5.1.1.	Means, range and standard deviations for blade vibration measurements in Hz for each of the 18 wheels for machine "A" (Firtree root).	87
5.1.2	Means, range and standard deviations for blade vibration measurement in Hz for each of the 24 wheels for machine "B" (Riveted root).	88
5.2.1.	Means, and standard deviations for nodal diameter mode vibration measurements for each of the 18 wheels for machine "A" (Firtree root).	92
5.2.2.	Means, and standard deviations for nodal diameter mode vibration measurements for each of the 24 wheels for machine "B" (Riveted root).	93
5.3.1.	Means and standard deviations for nodal diameter vibration measurements for each of the 18 wheels for stage 5 machine "A".	96
5.3.2.	Means and standard deviations for nodal diameter vibration measurements for each of the 18 wheels for stage 5 machine "B".	97
	Means and standard deviations for stage 5 machine "B" 12 wheels selected at random.	

LIST OF TABLES IN CHAPTER VI

		<u>Page</u>
6.3.1	Frequency spread of selected blades at various speeds for fundamental tangential blade mode for experimental wheel "A" (Firtree root)	112
6.3.2	Frequency spread of selected blades at various speeds for fundamental tangential blade mode for experimental wheel "B" (Riveted root) (unsupported blades)	113
6.3.3	Dynamic blade vibration test results for fundamental tangential mode for experimental wheel type 'A' (Firtree root)	115
6.3.4	Frequencies at 3000 RPM in Hz	117
6.3.5	Frequencies at 3000 RPM in Hz	117
6.3.6	Frequencies at 3000 RPM in Hz	118
6.3.7	Frequencies at 3000 RPM in Hz	119
6.3.8	Frequencies at 3000 RPM in Hz LP Steam turbine machine "A" (Firtree root) Set I	120
6.3.9	Frequencies at 3000 RPM in Hz LP Steam turbine machine "A" (Firtree root) Set II	121
6.3.10	Frequencies at 3000 RPM in Hz LP Steam turbine machine "B" (Riveted root)	122
6.3.11	Frequencies at 3000 RPM in Hz LP Steam turbine machine "B" (Riveted root, Unsupported blades).	123

LIST OF TABLES (IN THE APPENDIX) Page

Table 1	Static main blade frequencies in Hz of experimental wheel for machine 'A', (New before running).	141
Table 2	Static main blade frequencies in Hz of experimental wheel for machine 'A', (Just after dynamic test).	142
Table 3	Static main blade frequencies in Hz of experimental wheel for machine 'A', (Two weeks after dynamic test).	143
Table 4	Static wheel frequencies in Hz of experimental wheels (a) Experimental wheel for machine 'A' (Firtree root) (b) Experimental wheel for machine 'B' (Riveted root).	144
Table 5	Static main blade frequencies in Hz of last stage LP Steam Turbine machine 'A', Set 1.	145
Table 6	Static main blade frequencies in Hz of last stage LP Steam Turbine machine 'A', Set 2.	146
Table 7	Static main blade frequencies in Hz of last stage LP Steam Turbine machine 'A', Set 3.	147
Table 8	Static wheel vibration frequencies in Hz of machine 'A', Set I.	148
Table 9	Static wheel vibration frequencies in Hz of machine 'A', Set II.	149
Table 10	Static wheel vibration frequencies in Hz of machine 'A', Set III.	150

	<u>Page</u>
Table 11 Static wheel frequencies in Hz of machine 'A' (firtree) for 0, 1 and 2 nodal diameters.	151
Table 12 Static wheel frequencies in Hz of machine 'A' (firtree) for 3, 4 and 5 nodal diameters.	152
Table 13 Static wheel frequencies in Hz of machine 'A' (firtree) for 6, 7 and 8 nodal diameters.	153
Table 14 Static main blade frequencies in Hz of production wheel 1 for machine 'A'* (last stage) New just after manufacture.	154
Table 15 Static main blade frequencies in Hz of production wheel 1 for machine 'A'* (last stage) Six months after manufacture before installation	155
Table 16 Static main blade frequencies in Hz of production wheel 2 for machine 'A'* (last stage) New just after manufacture.	156
Table 17 Static main blade frequencies in Hz of production wheel 2 for machine 'A'* (last stage) Six months after manufacture before installation	157
Table 18 Static main blade frequencies in Hz of experimental wheel for machine 'B'.	158
Table 19 Static main blade frequencies in Hz of last stage LP Steam Turbine machine 'B' Set 1.	159
Table 20 Static main blade frequencies in Hz of last stage LP Steam Turbine machine 'B' Set 2.	160
Table 21 Static main blade frequencies in Hz of last stage LP Steam Turbine machine 'B' Set 3.	161
Table 22 Static main blade frequencies in Hz of last stage LP Steam Turbine machine 'B' Set 4.	162

	<u>Page</u>
Table 23 Static wheel vibration frequencies in Hz for machine 'B' Set I.	163
Table 24 Static wheel vibration frequencies in Hz for machine 'B' Set II.	164
Table 25 Static wheel vibration frequencies in Hz for machine 'B' Set III.	165
Table 26 Static wheel vibration frequencies in Hz for machine 'B' Set IV.	166
27 Static main blade frequencies in Hz of	167
Table & production wheel of last stage on a 120 MW	
28 machine type 'B' (riveted root)	168

LIST OF SYMBOLS AND ABBREVIATIONS

y	=	Deflection at time t at an angular velocity θ
f	=	Frequency of vibration.
w	=	Angular velocity.
f_R	=	Frequency at rotational speed R .
f_0	=	Frequency at zero speed.
R	=	Rotational speed.
f_{EX}	=	Magnet excitation frequency.
f_{PU}	=	Pick-up frequency.
R_c	=	Critical speed.
M	=	Major critical speed.
K, K_s	=	Rotational parameter.
\bar{x}	=	Sample mean.
\bar{d}	=	Mean difference.
s.d.	=	Sample standard deviation.
s. \bar{d} .	=	Standard deviation of difference.
c.s.s.	=	Corrected sum of squares.
d.f.	=	Degrees of freedom.
M.S.	=	Mean square.
F	=	Variance ratio.
s^2	=	Sample variance.
t	=	Student's t .
z	=	Area under the normal curve.

CHAPTER I

INTRODUCTION

All mechanical structures transmit forces.

These forces, because of the elasticity of the material, cause deflections in the structure. If the loads vary with time, then the fluctuating movement of the members, because of their mass, gives rise to further forces and additional distortions. Under certain frequency conditions these inertia forces become equal to the structure stiffness reaction and large amplitudes of vibration known as resonance build up. The high stresses which accompany these large amplitudes of vibration may cause sufficient fatigue damage for fracture to result.

In steam turbines components such as the rotor, disc and blades are designed to perform their main structural duty away from these critical resonances. Thus these components are prone to fail should they be subjected to unexpected excitation forces and the consequent fatigue damage. Most vibration problems in steam turbines have been found to occur in discs and blading. Other components which may fail due to vibration are compressors, shafts, intake and exhaust components.

For the last ten years a feature in the construction of steam turbines has been the marked rise in the unit ratings of machines. At the beginning of the 1960's the majority of large thermal machines in European installations were mainly in the 125 to 150 MW range. Today, both in Europe and in America, machines with an output of more than 1000 MW are being

installed. In these machines the volume of steam that has to be handled on emerging from the blading (in the last stage) may be of the order of 15,000 cubic meters per second to 30,000 cubic meters per second. In order to handle such enormous quantities of steam in a reasonable number of flows and to control the nozzle impulse frequencies, the design of blading and disc must be within the acceptable range of vibration. This is particularly true of the last row of blades, where the ~~total~~^{largest} heat drop of the steam flowing through the turbine is converted into mechanical energy.

The control of blade and disc vibration is of increasing importance. Resonances must be avoided and the blade assembly must be able to withstand the disturbances that arise when running.

To achieve smooth running of a steam turbine the vibration of the rotor must be controlled. The complex question of vibration includes all the phenomena which one usually associates with 'critical speeds'. The turbine rotor has a whole range of natural frequencies and any periodic force can excite resonance if its frequency coincides with one of them.

To analyse the problem two types of approach obviously suggest themselves. The first is a theoretical approach. Here it is assumed that the rotor is held rigidly in the bearing so that it can assume a certain inclination at the bearing supports but is unable to move vertically or horizontally; that blades are rigidly supported in the discs, etc. With these assumptions the natural frequencies and critical speeds of the

rotor, discs and blade can be calculated. However, in practice, a whole steam turbine is far too complex to conform to such simple assumptions. In spite of the high accuracy found in these calculations, the results frequently show discrepancies with measured values for critical speeds. In particular, in the case of blade vibrations, where the design of the blade is of considerable complexity, theoretical analysis even for a relatively simple system does not give results which represent the true behaviour of a wheel. This is especially true of the last low-pressure stage, where the blades are very long and have impulsive and reactive properties.

The second approach is to actually measure the natural frequencies and to analyse the ^{values} ~~level~~ of these frequencies. The technique of obtaining these measurements will be fully described in chapters II and IV.

This empirical approach was adopted in the Department with satisfactory results. The method, which will be discussed more fully in the review of literature, is based on using an 'experimental' wheel as a yardstick with which to analyse the 'production' wheels and from which to predict their behaviour under static and dynamic conditions. The reason for adopting this method is financial, since it would be extremely expensive to subject every 'production' wheel to dynamic tests. For this purpose the following measurements are taken:

- static blade vibrations for the last stage low-pressure turbine 'experimental' and 'production' wheels;

- static wheel vibration from zero to eight nodal diameters for all stages for 'experimental' and 'production' wheels;
- dynamic blade and wheel frequency measurements for all stages, but only for the 'experimental' wheels.

As may be imagined these measurements have provided ample data for description and analysis, some of which will be reviewed in chapter IV .

Whenever a large series of empirical measurements are taken, one has the problem of summarising the data so as to draw appropriate conclusions. The theoretical approach had highlighted the difficulties of finding a mathematical model which would encompass the full complexity of the design. It was therefore decided to analyse the data using suitable statistical techniques, which had not been tried in the Department before, and which would enable a comparison between 'experimental' and 'production' wheel measurements to be made.

Given the large volume of measurements available as a result of many years of testing, it would not have been practical for the purpose of this study to subject all to statistical analysis. Evidence from cases of failure which have been reported shows that a large proportion is due to fatigue in the material. This in turn is a condition which is most probably caused by excessive vibration. The problem of excessive vibration is most acute in last stage low-pressure turbine wheels because of the size and design of blading.

It was therefore decided to concentrate the analysis on this stage, and also to examine the behaviour of stage five, for purpose of comparison.

The problem was to find a concise and meaningful way of describing the measurements, which would enable the predictions from the behaviour of the 'experimental' to the 'production' wheels to be made with a known level of confidence.

CHAPTER II

2.0 REVIEW OF PREVIOUSLY PUBLISHED LITERATURE

The vibration of steam turbine blades and discs is a matter of considerable practical importance and a considerable volume of literature has accumulated in the last ~~hundred~~ ^{fifty} years. The appearance of so many papers on the subject in recent years could possibly be explained by the desire of some authors to justify different methods and to introduce more rigorous and fundamental analysis. Their approach seems broadly to fall into two categories:

- (a) Mainly theoretical, backed by mathematical models;
- (b) Mainly empirical, based on techniques of measuring the vibrational characteristics of wheels and blades, both statically and at high rotational speeds.

2.1 Empirical investigation

The trends towards a more empirical approach began after the publication of Wilfred Campbell's brilliant contribution in 1924. Since that time an increasing number of papers have appeared in which the method of dealing with the subject varies only in technique, due to improved instrumentation resulting from the advance of electronics.

The purpose of the first part of Campbell's (1924) paper was to present the main feature of the work done by the General Electric Company in the United States. It reports the

causes of failure of steam turbine blades and discs.

Subsequently he reported the investigation of various special phases of vibration phenomena. The resonant frequencies and nodal patterns of vibrating bladed turbine wheels were investigated by exciting the wheel by means of an electromagnet which was clamped with its poles close to the edge of the wheel. Sand was scattered over the wheel surface. The frequency of the magnetic pulse was varied until a particular frequency was reached at which the wheel responded. Because at that time it was difficult to observe the motion of the disc in diametral vibration, Campbell illustrated it by sand pictures, to identify the nodal pattern of each resonance. He also observed that:

- (a) every disc wheel responded readily to vibrations of four, six, eight, etc. radial nodes, each type of vibration having its own characteristic frequency;
- (b) the higher the number of nodes the more difficult it is to force the sand figures towards the centre of the disc;
- (c) the higher the number of nodes the higher the ^{frequency} ~~vibration~~ and the less easily is the vibration excited;
- (d) both the disc wheel and the blades vibrate together as a continuous disc and must be treated as a unit in this type of vibration.

It is important to note that the vibration which takes place with zero and one nodal diameter requires hub reaction and is more easily excited on the solid forged rotors. ~~This~~

~~type of excitation exerts a couple on the shaft and is of a different kind to that with two nodal diameters or more.~~

When the wheel is stationary the natural frequency at which it will vibrate depends on the particular mode of vibration as indicated above, and the pattern is of a relatively simple character. When a wheel is set in motion however, a new concept is necessary to appreciate the type of vibration that may arise. One of the main ideas is to relate the sand picture to a mathematical model and to make a comparison between the nodal pattern and wave theory.

Campbell makes the following comments on the comparisons between standing vibrations and the corresponding travelling waves for a given disc:

- (a) because of the continuity of the circumference, it is only possible to have an integral number of nodal diameters. An odd number of radial nodes would lead to the absurd position of having one part of the disc going in two opposite directions at once;
- (b) in the standing vibrations the nodes are stationary in the wheel;
- (c) the frequency of vibration of every particle along the edge is the same for both standing vibrations and travelling waves;
- (d) for a standing vibration the particles along the edge of the wheel all vibrate with the same phase, but their amplitude varies

successively between nodes.

The sand pictures in the static test are obviously produced by a stationary vibration in the disc - that is, one in which all parts of the wheel are vibrating in phase and the amplitude varies sinusoidally round the periphery, being positive in one inter-nodal phase, negative in the next and so on. Pochobradsky, Jolly and Thompson (1931) state that it is possible for a wheel to vibrate in this way during rotation.

Let the two travelling waves be

$$Y = a \cos (n\theta + pt) \text{-----} (a)$$

$$Y = a \cos (n\theta - pt) \text{-----} (b)$$

with the same angular velocity ($\omega = \frac{p}{n}$) and

amplitude, but travelling in opposite directions.

When these are superimposed they produce the

standing wave

$$Y = a \cos (n\theta + pt) + a \cos (n\theta - pt)$$

and to simplify

$$Y = 2a \cos n\theta \cos pt$$

where Y = deflection at time t at an angular
position
velocity θ

n = number of nodal diameters

f = frequency of vibration ($p = 2\pi f$)

ω = angular velocity ($\omega = 2\pi R$) of the wheel in rads/s

R = " " " in revs/s
~~wheel of radius R~~

θ = angular position in space

When the velocity of the backward wave is equal to the angular velocity of the wheel, the wave becomes stationary in space and the vibration as viewed by a stationary observer appears as a permanent deformation.

By substituting θ by $(\theta - \omega t)$ and ω by $2\pi R$,
equations (a) and (b) become

$$Y = a \cos [n\theta + 2\pi t (f - nR)] \quad \text{---(a)}$$

$$Y = a \cos [n\theta - 2\pi t (f + nR)] \quad \text{---(b)}$$

For the wave to become stationary in space, the
angular velocity p/n of the backward wave is equal
to the angular velocity of the wheel ($\omega = 2\pi R$);
which leads to the expression

$$f = nR$$

when this is substituted in a',

$$Y = a \cos [n\theta + 0] \text{ which is a standing wave}$$

Therefore $f = nR$ is a critical condition.

For any given wheel there is a range of critical speeds corresponding to different numbers of nodal diameters, and it is found that the amplitudes are largest for fewest nodal diameters. Reeman and Luck (1951) explained this critical condition and pointed out the serious trouble which occurs at certain major critical speeds when the lack of perfect circumferential symmetry in the forces acting on the wheel produces a vibration in the rotating wheel which is equivalent to a standing wave in space. For example, for such a critical speed to occur for, say, a two nodal diameters vibration at 3000 rpm the frequency of the two nodal diameters vibration in the rotating wheel would be 100 cycles per second, and for three nodal diameters vibration, 150 cycles per second. In effect a major critical speed occurs when the frequency of the n nodal diameters vibration (f_n) in the rotating wheel is such that $f_n = nR$, where R is the rotational speed.

Some vibrations may be excited when f_n is any multiple of the running speed, i.e. when $f_n = mR$. These speeds give rise to what are known as 'minor critical speeds' and seldom cause any serious trouble in the turbine. If however n is equal to m , the vibrations in the wheel correspond to a stationary wave in space, and this produces the 'major critical speed'.

The static test however only indicates frequencies of elastic vibrations in the wheel. When the wheel is running, one must superimpose on these the effect of centrifugal forces.

Campbell shows that the effect of centrifugal force when a turbine wheel rotates increases with the frequency of vibration and blade fixation. In general the centrifugal force produces a stiffening effect.

The relationship between the frequencies of the disc when rotating and when stationary could be expressed as

$$f_R^2 = f_0^2 + KR^2$$

Where f_R = is the frequency when rotating

f_0 = is the frequency when stationary

K = is the rotational parameter

\sqrt{R} = is the rotational speed

Luck (1962) shows that the value of K depends upon the wheel diameter. He takes an ideal case of a cantilever attached to a rotating wheel and goes on to say that

the value of K depends on the dimensions and the mass of the cantilever. Assuming K to be constant for one particular mode, the relationship between f_R^2 and R^2 is linear. He carried out an investigation of the cantilever with ideal end fixation and concludes that K is always positive. Collingham (1931) also indicates that the values of K depend upon the shape of the wheel, the root fixation and the manner of the support on the shaft. All these assumptions seem to be in line with Campbell's paper.

The effects of all these factors cannot be included in an analytical treatment of the problem. For this reason the practice of carrying out tests by means of an 'experimental wheel' was adopted in the Department.

Static tests showed that when the difference between the resonance frequency of the disc at a particular nodal diameter and the exciting frequencies which can occur in the turbine was small, any increase in frequency due to centrifugal force might cause resonant vibration in service. When this is the case it is usual to re-design the wheel to alter its natural frequencies sufficiently to remove them from the danger range.

A plot of frequency against rotational speed for blades and discs with different modes was first suggested by Campbell as a means of analysing the vibration characteristics. For this purpose it is usual to define the rotation parameter

$$K = \frac{f_R^2 - f_o^2}{R^2}$$

After finding the value of K the critical speed can be deduced from the equation

$$R_c = \frac{f_o}{\sqrt{n^2 - K}}$$

where R_c = critical speed
 f_o = resonance frequency of the wheel
when stationary
 n = ^{n^e of} nodal diameters
 K = rotational parameter

In determining major critical speeds great use is made of this parameter.

According to Armstrong (1955) the above method will not take care of the coupling effect between turbine blade and the disc vibration. In order to measure the response of such a system he developed a technique which is based on receptance theory and measured the response by means of a specially developed pick-up and an exciting force dynamometer. He measured the direct driving point receptance of a uniform disc. The change in the driving point receptance of the system due to the addition of the blades to the disc was also observed. He pointed out that by twisting the blades through known angles the effect on the frequencies of the system could be determined.

The paper by Cave, Luck and Mitchell (1963) deals mainly with the design from the vibrational standpoint of low pressure blading for the last stages of 500 MW, 3000 rpm turbines. It contains a brief summary of Campbell's extensive work and explains techniques and methods of analysing the measurements obtained from static and dynamic tests. They discuss the two main characteristic features of blading which are

of particular significance in designing blades free from vibration failures. The first is the root fixation and the second is the type of coverband. The riveted fork-type root fixing, with varying degrees of refinement, has the important property that the rigidity of the blade fixing changes by only a relatively small amount with speed of rotation and is little affected by temperature differences between rotor and blading. The blades are further stiffened at the tips by the use of a coverband, which also provides a means of sealing against tip leakage. Thus each blade on a wheel is held in much the same way, and, as far as vibration is concerned, may be regarded as similar to its neighbour. However, they point out that if blades are more than 20 inches long a flat coverband is not satisfactory due to the bending stresses and centrifugal forces. They suggest two types of construction

(i) lacing wire

(ii) arch type coverbands. (see Fig. 6 p. 55).

The former has a smaller mass per pitch than the latter. The introduction of lacing wire at last stage wheels brings a number of disadvantages. One of these is the difficulty of pin-pointing vibration characteristics when batches of blades are laced together. Another is that the attachment or passage of the lacing wire through the blades introduces undesirable weakening and stress concentration. This has recently been measured by the writer and found to be critical.

On the other hand, the advantages of the arch coverband are that

- (a) it can accommodate circumferential compression;
- (b) it can accommodate differential expansion of the blades due to change of temperature. This is achieved by the circumferential elasticity of the arches which limits stresses in the rivets that attach the arch element to the blade tips to simple shear and means that the heads of the rivets do not have to withstand tensile force. This enables "temperature differences of several hundred degrees Farenheit to be accommodated" (Cave, Luck & Mitchell, 1963, p.46);
- (c) each blade is under identical conditions of constraint; and
- (d) the system preserves all the desirable features and conditions so far as vibration is concerned.

Cave, Luck and Mitchell claimed, and rightly so, that due to the consistent nature of the above design of blading it can be assumed that the natural frequency varies inversely as the square of the length and the linear dimension in the direction of vibration. The following geometrical similarity is therefore applicable

$$\frac{b_2}{b_1} = \frac{(L_2)^2}{(L_1)^2}$$

i.e. the axial width at the base section must vary as the square of the length

where b = axial width at the base of the blade

L = free length of the blade.

This is an over-simplification of the system. In design, account must also be taken of the other relevant factors, such as cross-section and the rate of twist. No special difficulties were encountered in the design of longer blades with arch coverbands, provided consideration was given to elastic stability, since the arch system developed heavy circumferential compression when at speed.

As was mentioned in the Introduction, the practice in the Department is to subject the 'experimental' wheel and the 'production' wheels to different tests. Cave et al. (1963) also report an investigation into the effect of blade material on natural frequencies. To test the effect of material samples of each blading alloy were taken from batches supplied for the manufacture of the experimental and production blades. They were subjected to temperature rises from 50 to 300 degrees Fahrenheit and it was found that the variation in natural frequency resulting from the temperature difference amounted to at most 1.5% and the difference between the two wheels was not more than 1%.

Mitchell (1969) shows the importance of blading design and its effect on increased power output. He also explains the importance of rotor construction and casing design for both vibration and stress.

Harris (1968) discusses the development of components for large steam turbines and states that successful designs have three characteristics

- (a) high efficiency,
- (b) ~~availability~~ ^{availability} not impaired by breakdown ~~and~~ (i.e. high reliability) and
- (c) low cost.

He also examined the mechanical problems involved in extending steam turbine design to the highest foreseeable rating.

Another important factor to take into account in design ~~are~~ the thermal stresses. The turbine disc is usually subjected to large turbine temperature gradient during its operation. The effect of this is to introduce tensile

tangential stresses in the bore and compressive tangential stresses at the rim, together with radial stresses peaking somewhere on the diaphragm. These thermal stresses are additive to the centrifugal stresses and their effect is to increase the maximum stress occurring in the disc, to increase the maximum radial stresses in the diaphragm, but to reduce the tensile tangential stresses occurring at the rim, and in fact on occasion to change its sign.

Dawson (1966) confirms the above statement and goes on to illustrate that high temperature components in large turbines are subjected to considerable temperature changes each time the turbine is started and stopped and the resulting transient temperature distribution causes the material to undergo thermal stress/strain cycles. It is therefore necessary to devise methods of assessing thermal stress levels and resistance to thermal fatigue, so that an optimum design of components can be developed. In the case of turbine blades one can outline the problems of thermal stresses which are likely to occur:

- (a) creep is most likely to occur in the mid-span region;
- (b) non-uniform cooling leads to thermal stresses.

Dawson in his paper lays down some general form of analysis for the suitability of a new design for cyclic operations.

Reeman and Luck (1951) reported blading failures and discussed the causes of the failures. It is often difficult to pinpoint the exact nature of failure. The techniques of investigation to build up a satisfactory picture of the nature and sequence of events are based on visual inspection and

questions about the sequence of operation. Close inspection of failed components with the naked eye and with the aid of a ^{magnification} low/stereo microscope often yield much information, but in many instances damaged surfaces and metallographic sections need to be examined by high power optical and electron microscopes. Scott (1957) pointed out the usefulness of electron microscopes in the study of wear.

Wozney (1921) describes some of the techniques developed for conducting experimental vibration-fatigue studies of high speed rotating machinery. He pointed out that where the design is complex, as in turbines, the prevention of fatigue failure is of primary concern.

Campbell and Heckman (1925) describe how the tangential vibration affects the performance of steam turbines and suggest remedies to avoid this kind of vibration. This paper elaborates the thoughts and ideas expressed in Campbell's earlier publication and supports the practical suggestions with a mathematical analysis.

It is worthwhile at this stage to refer to Luck's (1966) concise entry on 'Vibrations of Turbine Blades' in the "Encyclopaedic Dictionary of Physics Supplementary Volume 1". The term 'blade vibration' he states (p.1) "is a convenient one to describe certain modes of the whole turbine blade-wheel system where the maximum movement occurs in the blading. Other types of vibration, known as axial disc vibrations, where the wheel vibrates with node loci along nodal-diameters also occur and are important in turbine design."...

"For a stage where the blades are held together at the tips by a continuous shroud, the concept of blade vibration is best obtained by reference to the modes of vibration of an isolated cantilever bar which is firmly clamped at the root and supported at the tips." Luck illustrates the lower modes of vibration in such a bar - fundamental flap, edge and torsional - in the figures reproduced below.

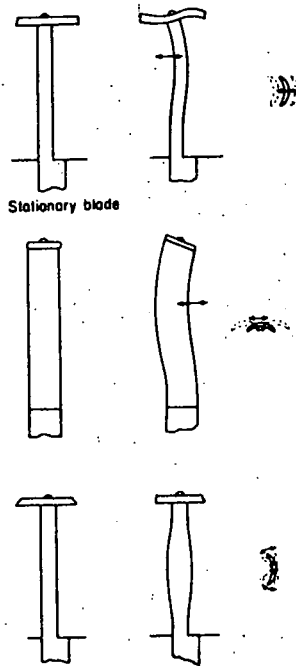

Fig. 1.

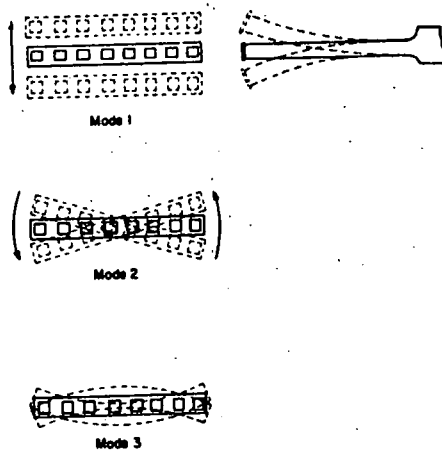

Fig. 2.

Koenig (1926) describes the transverse vibration of steam turbine discs and examines the effect of vibration on all other relevant components besides blades and discs, such as flexible couplings, effect due to partial admission of steam on the nozzle group, and on turbine rotors.

Smith (1933) gave a detailed analysis of the motion of a rotor carried by a flexible shaft in flexible bearings. Jeffcott (1918) deals with the theoretical analysis of lateral vibrations of loaded shafts. Prohl, (1945) indicates the general method of calculating the critical speeds of flexible rotors. Harris (1968) explained the importance of the attachment of the blade to the rotor and described some very ingenious methods of attachment. He also classifies the different forms of LP rotors, i.e. separate disc, monobloc forging or welded. The level of residual stresses in a welded rotor has recently been measured by the writer in the Department.

2.2 Theoretical Approach

At this point it may be worth examining some of the theoretical analyses of the problem of blade vibration.

We are indebted to Stodola for the basic method of calculating the frequencies of bladed discs. He was the first to point out that turbine discs were liable to transverse vibrations and developed a theoretical method to calculate them. Koenig (1926) based his theory for ascertaining the natural frequencies of discs on Rayleigh's theorem. He describes Stodola's mathematical expressions for kinetic and potential

energy of vibrating discs as rather lengthy and unsuitable to take account of the so-called 'boundary conditions'. He considered Kirchoff's definition of boundary conditions more exact and adopted these when calculating frequencies following Rayleigh's theory. In the first instance the method yields the frequency of the wheel at rest only. The effect of centrifugal forces must then be superimposed according to Stodola's formula. Malkin (1942) also proposes Rayleigh's approximate method, but assumes different analytical expressions for the disc and blade deflection shapes.

Rao and Carnegie (1970) make use of the Ritz-Galerkin method for determining the lateral frequencies of vibration of tapered cantilever blades of rectangular section. In their investigations three modes of vibration are considered. They make a comparison between experimental results and frequency parameter ratios (defined as the ratio of the frequency parameter for a tapered beam (λ) to the fundamental frequency parameter of a uniform beam λ_0) (λ/λ_0) and claim close agreement with experimental results as shown by Carnegie, Dawson and Thomas (1965, 1966).

The natural frequency of vibration of a blade is almost always increased by the effect of blade twist, irrespective of whether the mode is in the flap or torsional sense. This effect is particularly pronounced for Parson's last stage blades, which are partly of an impulse and partly of a reaction type, with a twist from root to tip. A few computer programs have been written to take account of the twist in the calculations, using a variety of techniques, such as finite

element method. However, the results obtained by using these programmes ^{are} is not in agreement with actual measurements, and it seems therefore that the techniques cannot account for the whole shape.

Carnegie (1967) developed the extended Holzer process and applied it to the problem of lateral vibrations of turbine blades. He did not take centrifugal forces into account. The procedure is a numerical one and follows Den Hartog (1965).

Prohl, (1958) suggests a method of calculating vibration frequencies of a laced group of turbine blades. The method of analysis is based on digital computation and it is claimed that it will give both natural frequencies and mode of a group of blades. He emphasises that the assumptions are based on simple beam theory. Rissone and Williams (1965) also describe a method for coupled vibration suitable for programming a digital computer, in this case assuming a non uniform cantilever beam.

Test results in the Department on groups of blades mounted on a plate to simulate conditions on a wheel show close agreement with fundamental tangential and axial mode frequencies measured on groups of a fully bladed wheel. Measurements on blades of at least four different lengths are within $\pm 10\%$ of a mean curve (a plot between frequency and length) and can be regarded as a possible zone of blade vibrations.

The phase relationship from blade to blade measured in a group agrees well with calculations for an

idealised group. The close agreement between frequencies on a group and on the wheel confirm the existence of blade group vibrations on a fully bladed disc, where many blades take part in the vibration and which explains the phenomenon of the multi-peaked response curve encountered on some wheels investigated.

Reeman and Luck (1951) obtained these multi-peaked response curves in experimental tests. Armstrong (1955) reports speculations about these curves. Each individual peak of the curve could be caused by a particular portion of the system resonating itself. These portions could either be blade packets or individual blades.

2.3 Techniques of measurement and Instrumentation

Before concluding this review of published literature, reference must be made to the development of advanced methods of measuring vibration frequencies which have resulted from the availability of highly sophisticated equipment.

The development of techniques of measuring vibration derived great impetus from the need to solve urgent practical problems. The most important objective is to find the magnitude and behaviour of vibration forces within the structure of a component. It is not surprising therefore to find many attempts at devising accurate measuring techniques.

Freudenreich (1925) described a series of tests carried out at Brown Boveri & Co. Ltd., Baden, Switzerland, to determine the vibration of blades and discs. Both static and dynamic tests were carried out following the theoretical analysis of Professor Stodola. The basic principles still apply to the

methods used in the Department today, but the instrumentation has changed considerably.

Campbell in his pioneering work relied upon gravity forces to excite long blades on rotating wheels, making measurements only when the blade natural frequency was an exact multiple of the running speed. He also used a small steam jet to increase the impulse received once per revolution. This method of exciting blade vibration has obvious limitations. Measurements are only possible at certain speed and control over the mode excited is poor.

2.3.1 Use of gauges

A search began for suitable means of exciting blade vibration by a device attached to and rotating with the wheel. The requirement for such a device is the ability to withstand high centrifugal pull. It therefore had to be able to excite large turbine blades producing perceptible vibrations through extremely small and light gadgets.

The solution to the problem was found in piezo-electric material. Luck (1962) described the crystal strain gauges produced at the Wembley Research Laboratories to meet the requirements of turbine blade vibrations. Blade and wheel vibrations are conveniently excited and detected by using these gauges. Close control of exciting frequency is possible and the method can be used for both dynamic and static measurements.

Barium titanate was the first material used and the gauges consisted of a slip of material with a silver film to form two electrodes. Connecting leads to the surface of the

gauge provide a means of taking off the signal when the crystal is strained and of applying a voltage for exciting purposes. It is suggested by Ripperger (1952) that such gauges are capable of responding to strains in all directions. Typical dimensions are 1.0" x 0.25" x 0.50" and they weigh little more than conventional gauges. They may be glued to the surface of the blade by any one of the many techniques used for attaching this type of gauge. Armstrong (1955) carried out experiments to determine the comparative sensitivity of these gauges and found it to be 2.8 mV per lb/sq in stress in steel.

Bottomley and Augustine (1968) describe the experimental technique of measuring turbine blade vibrations using piezo-electric gauges. They carried out tests on fully bladed wheels both statically and dynamically. Static tests of blades are relatively simple and cheap. Dynamic tests simulate running conditions and provide information on the effect of rotation on the frequency of vibration. They placed the wheel in a vacuum chamber and employed one or more stationary DC magnets close to the blades to excite the characteristic vibration of the assembly. The vibrations, which are sensed by piezo-electric crystal gauges, are recorded on a specially designed multi-channel magnetic tape, processed through electronic analysing equipment and presented on diagrams of frequency plotted against rotor speed.

Originally the system consisted of the blade excited by an electromagnet, driven from a power amplifier, and an oscillator. The frequency of the electromagnet was varied by hand over a specified range. The frequencies at which resonance

occurred were noted. Resonances were detected by transducers mounted on the blade and coupled to an oscilloscope via a band-pass filter which was also manually adjusted to reject any harmonics simultaneously excited. The multi-channel tape mentioned above was designed by Bottomley and Augustine to provide an automatic recording of frequency identification.

2.3.2 Holography

The application of holography to analyse the vibration characteristics of turbo machinery has been increasing and is overtaking more conventional methods such as strain gauges and piezo-electric crystal contact probe methods. Hockley and Butters (1970) describe holography as a routine method of vibration analysis. It requires a coherent light source, in which the light scattered from any part of an object is capable of interfering with the light projected directly on all parts of a recording plate. The ability to form an interference record is directly related to the temporal coherence of the source, which is a function of bandwidth.

A coherent light source is characteristic of a He-Ne laser which emits light at a discrete wavelength of .6328 micron and a typical bandwidth of about 3×10^{-7} micron, the corresponding coherence length being about 50 cm. An ordinary light source on the other hand emits over the whole band of the electromagnetic spectrum from 0.40 to 0.70 micron with almost zero coherence.

Holography is a method by which both the phase and amplitude of wavefront scattered from an object is

illuminated by coherent light and recorded in the form of an interference pattern on a photographic plate. This wavefront can be reconstructed by illuminating the photographic plate with coherent light to form the complete three-dimensional image of the object.

The technique was devised as long ago as 1948, but only after the discovery of light with the coherence of that of the laser beam was utilisation possible.

There are different techniques for static and dynamic vibrations. The image created by means of a diffraction of the laser beam at the hologram plate is identical with the original surface of the component from which coherent light was reflected. Hence information regarding the original surface can be obtained and stored so that it may be compared with information from the surface at a later time. In fact the two sets of information can be stored on a single plate for ease of comparison, any difference between the two conditions will show as interference fringes, each representing a half wavelength displacement.

The holographic technique used for investigating dynamic deflection is known as 'time-averaged' method. The hologram recorded is made up of all the wavefronts scattered from each position of displacement. The amount of light received from each position will be weighted by the relative time spent in each position. The nodal line will show as a bright line since no displacement takes place at that point. At other points there will be fringes which are less bright, but which are produced by interference between the light reflected from the

surface when it is at the extremities of its vibratory amplitude.

For illustrations of holograms and explanatory diagrams for the method of recording the holograms and reconstructing images reference can be made to Hockley and Butters (1970).

It can be concluded that the simple holographic technique can give useful strain and vibration information for turbo-machinery components. Hockley and Hills (1969) also consider that holography offers an attractive alternative to the established engineering methods of detecting the vibrational modes of components.

2.3.3 Radio telemetry method

One of the most significant advances in the field of vibration measurement on steam turbines is the development of the contactless telemetry system. The continuing occurrence of blading failures due to vibration fatigue in turbines in service prompted the Central Electricity Generating Board to initiate the development of means of measuring blade vibration in machines in normal operation.

Strain gauge technique for measuring dynamic vibration of blades and wheels was the usual way of determining vibration characteristics and of producing valuable information for continuing design studies. The carbon brush slip-ring was the only method of obtaining experimental data. Operations with slip-rings were hampered by mechanical problems such as brush wear and brush bounce, which combined to distort and obliterate the signal.

Cave, Norman and Luck (1964) pointed out that the slip-rings must be located outside the steam space. Therefore this method requires radial drilling of the shaft to connect the strain gauges to the electronic apparatus located in the shaft bore and to the slip-rings. Because the need to drill radial holes through the shaft may be a limitation of the application of this method to some machines, Jones (1963) at the Central Electricity Research Laboratories developed a contactless radio telemetry method whereby all apparatus can be attached to the rotor near the strain gauge position. The system is described fully in his paper. As carried out in the Department it is as follows:-

The system consists of three parts: that which rotates with the rotor, i.e. capsules, modules, wiring and strain gauges; that connected to the turbine casing, known as the static ring, which contains the power coils and serial loop; and thirdly, a large amount of stationary ground equipment, to receive and display the transmitted signal.

Each telemetry capsule contains two transmitting channels supplied from a common power source. The strain gauge and transmitter circuits are contained in two precision moulded modules which fit into the outside pockets in the capsule body. The power supply module fits into the centre pocket. The capsule transmitting coils and power pick up coil are moulded into the front face of the capsule.

The static ring makes up the primary magnetic circuit for the power transmission. The whole of the coil

system is then encapsulated and the aerial loop is inserted into grooves machined into the front surface of the ring.

The ground equipment consists of an amplifier driven at 50 Kc/s to provide power for the static ring and hence the capsule modules, a number of Frequency Modulus receivers tuned to the transmitter frequencies, a multi-channel tape recorder to record the receiver outputs and oscilloscopes for visual scrutiny of the recorded signal.

Cave, Norman and Luck (1964) state that although the telemetry method overcomes the necessity of drilling the turbine shaft, the system, apart from being difficult to instal in many machines, has two major disadvantages for vibration tests on turbines in service:

1. It restricts measurements to an end stage, or involves a lengthy and very difficult wiring operation.
2. It adds to the stage a mass which will slightly alter its disc vibration characteristics and may obscure the usefulness of the results obtained.

The same authors report results obtained from the application of the telemetry system to machines installed at Northfleet Power Station. Strain gauge signals were observed during runs up to speed and attempts were made to measure the frequency of any signals received. On the Northfleet machine readings of frequency were obtained at 3,000 rpm. The frequency corresponded to that expected for the blade fundamental

tangential mode. One can therefore estimate the value of the rotational parameter K from the formula

$$f_R^2 = f_o^2 + KR^2$$

and compare the value of K with results obtained from the 'experimental wheel' using strain gauge technique with slip-rings. It was found that there was close agreement between the values of K obtained by the two different methods.

Krassick (1968) reviewed several phases of the development of a miniature high speed telemetry system for dynamic analysis and describes the telemetry system that finally evolved. In his conclusion he points out that a major factor in establishing durability in turbine wheels has been the ability to determine stress levels in turbine wheels and blades under actual operating conditions. He goes on to say that the telemetry transmitter extended this ability into the ultra high speed range.

CHAPTER IIIMACHINE 'A' AND MACHINE 'B' - TWO TYPES OF LP TURBINE WHEELS

3.0 It was stated in Chapter I that the problem of excessive vibration is most acute in last stage low-pressure turbine wheels. For this reason two types of bladed wheels have been selected for special study. The two types differ mainly in the design and method of root fixation of the blades. For the sake of brevity of description the two types of designs will be referred to as 'Machine A' and 'Machine B' throughout the following chapters. More detailed definitions and description are given below. In both cases the reference is to the wheel of the last or sixth stage low-pressure turbine. The typical layout of such a turbine is shown in Fig. 1 and a single double flow rotor can be seen from Fig. 2. The turbine comprises an HP rotor of 12 stages, a double flow IP rotor of 8 stages and three double flow LP rotors of 6 stages each side. In Fig. 1 special attention has been called to the six wheels which are designated starting from the steam inlet: LP1 steam end, LP1 alternator end, LP2 steam end, LP2 alternator end, LP3 steam end and LP3 alternator end. These six wheels collectively are referred to as one Set. (See also Tables 5, 6, 7 and 19 to 22 in the appendix).

3.0.1 A cross-section of Machine A and Machine B is shown in Figs. 3 and 5. It can be seen that the overall diameter of both bladed wheels is 11ft. 4 in. As for other dimensions, they differ in very minor respects owing to the major difference between the two: that of design and method of root fixation. In both types of machines the tips of the blades have been connected by an arch-coverband, at approximately 5" from the end.

3.1 Arch coverband.

For blades longer than 20 inches it is not possible to use any form of flat coverband, as it would require very deep sections to keep bending stresses within reasonable limits. Otherwise the centrifugal force would become unduly high and cause overstressing of the rivets by which the coverband is attached to the blade tips. As the length of the blades in the two types of machine is 36 in. the problems mentioned above have been avoided by the use of an ^{arch} ~~large~~ coverband.

An arch coverband is constructed by inwardly bowed arch elements which are located between each pair of adjacent blade tips. (See Figs. 4 and 6). Under the action of centrifugal force the arches develop circumferential compression. This means that the centrifugal force is resisted principally by the arch action and not by the development of bending stresses. At the same time differential expansion due to temperature and elasticity are accommodated.

3.2 Machine A - fir-tree root blades.

These blades are known as side entry blades. The rotor carries a comparatively heavy rim in which closely spaced slots are cut, one to each blade. The slots may be either parallel or skew to the axis, depending on the blade root profile. For machine 'A' the slots are parallel (See Fig. 4). The design incorporates a principle which may be termed the principle of diminishing cross-sections. Considering the blade only, the area of the material under tension is made a maximum at the outermost section; the middle section takes a further share of the pull, so that the area of the innermost section may be still further reduced.

The advantages of this form of attachment are:-

- (i) The width of the wheel rim may be made greater than the width of the blade, so reducing the maximum stress in fastening;
- (ii) The bending across the outermost section may be more or less eliminated by suitable positioning of the blade;
- (iii) The renewal of any blade is relatively simple.

3.3 Machine B - riveted root blades.

This form of attachment has a greater influence on the shape of the wheel rim than the fir-tree root attachment but it also involves a fairly heavy rim. The required number of holes are drilled in the rim of the wheel parallel to the axis. The corresponding slots for the blade tang are then finished by milling.

For smaller wheels the rivets are sometimes staggered. For machine 'B' there are three rivets for each blade (See Fig. 6). This type of root construction has the important property that the rigidity of blade fixing changes by only a relatively small amount with speed of rotation and is little affected by temperature difference between rotor and blading. One of the disadvantages is in the manufacturing process of the attachment. Each blade has to be milled and aligned individually which makes the alignment of the total ring of blades rather cumbersome.

3.3.1 The behaviour of the two types of machine under vibration is the subject of Chapters 5 and 6. It may be worth adding that the different root fixations entail considerable differences in manufacturing procedures. These will be discussed in Chapter 7.

3.4 Stage five.

In Chapter 5 stage five wheels were analysed for the purpose of comparison. Wheels are referred to as "stage 5 of machine A" because the data available happened to belong to the stage 5 wheel on the same rotor as machine A. However the design of stage 5 wheels is the same for machine A and B. It has riveted roots and a continuous coverband.

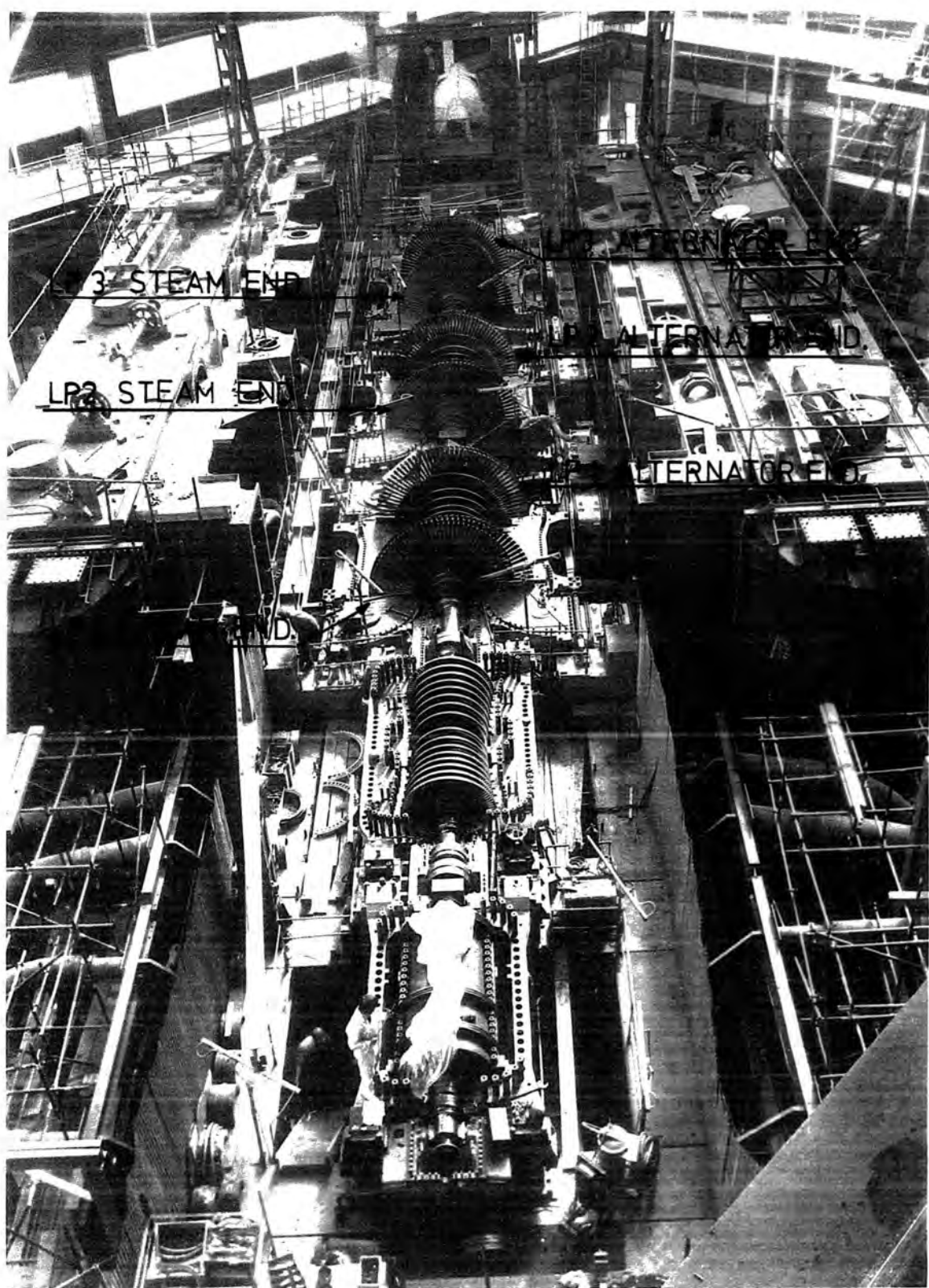

660. MW. 3000 rev/min STEAM TURBINE TYPICAL OF
MACHINE A DURING ERECTION ON SITE.

FIG.1.

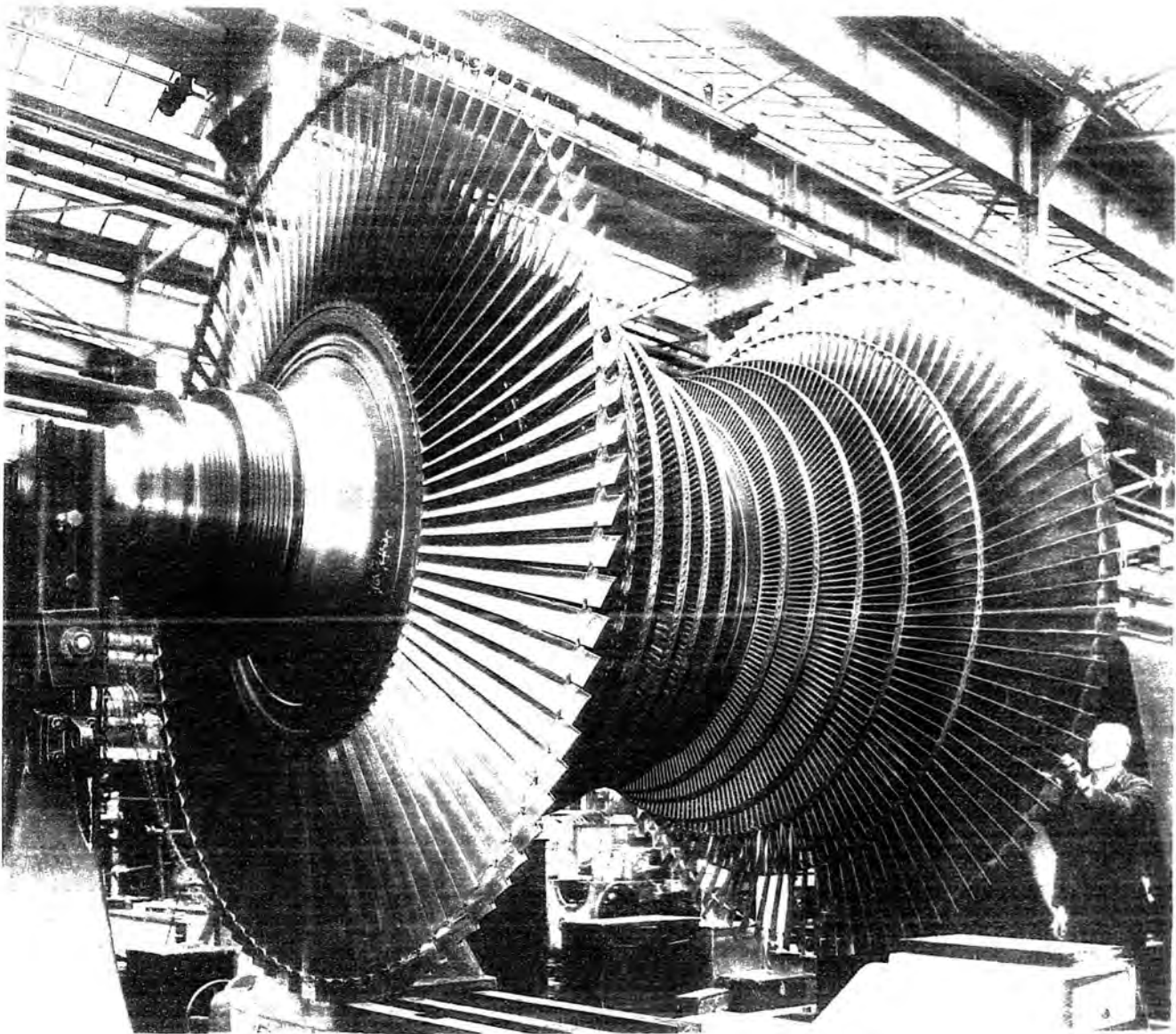

BLADED ROTOR FOR DOUBLE-FLOW L.P. TURBINE

TYPICAL OF MACHINE "A" 660 MW OUTPUT

SHOWING ALL SIX STAGES EACH WAY.

CROSS SECTION OF EXPERIMENTAL WHEEL
FOR MACHINE "A."

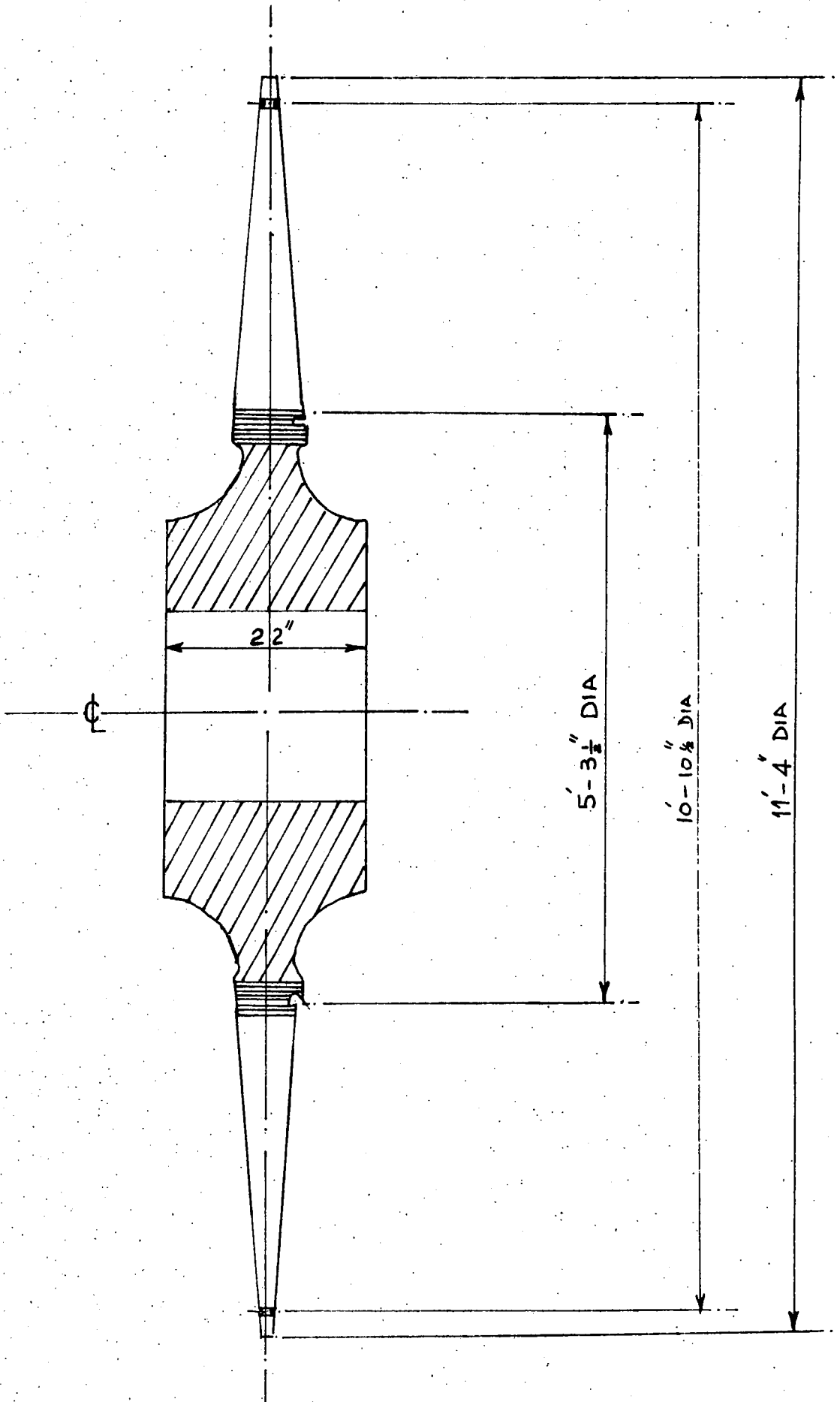
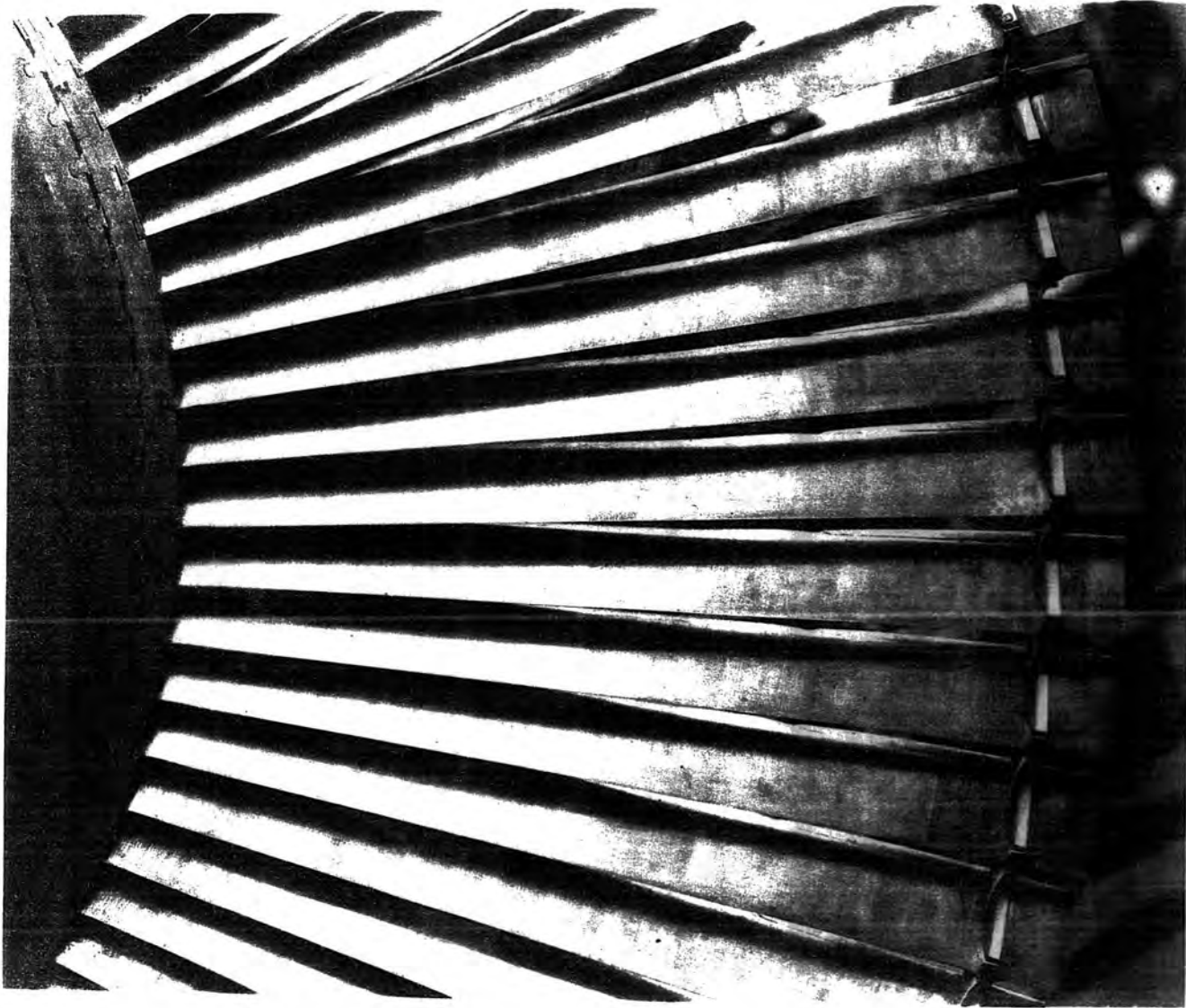

FIG. 3.



ARCH COVERBAND BLADE ASSEMBLY, TYPICAL OF MACHINE "A" (FIR TREE
ROOT) LOW PRESSURE SETS

FIG.4.

CROSS SECTION OF EXPERIMENTAL WHEEL
FOR MACHINE "B"

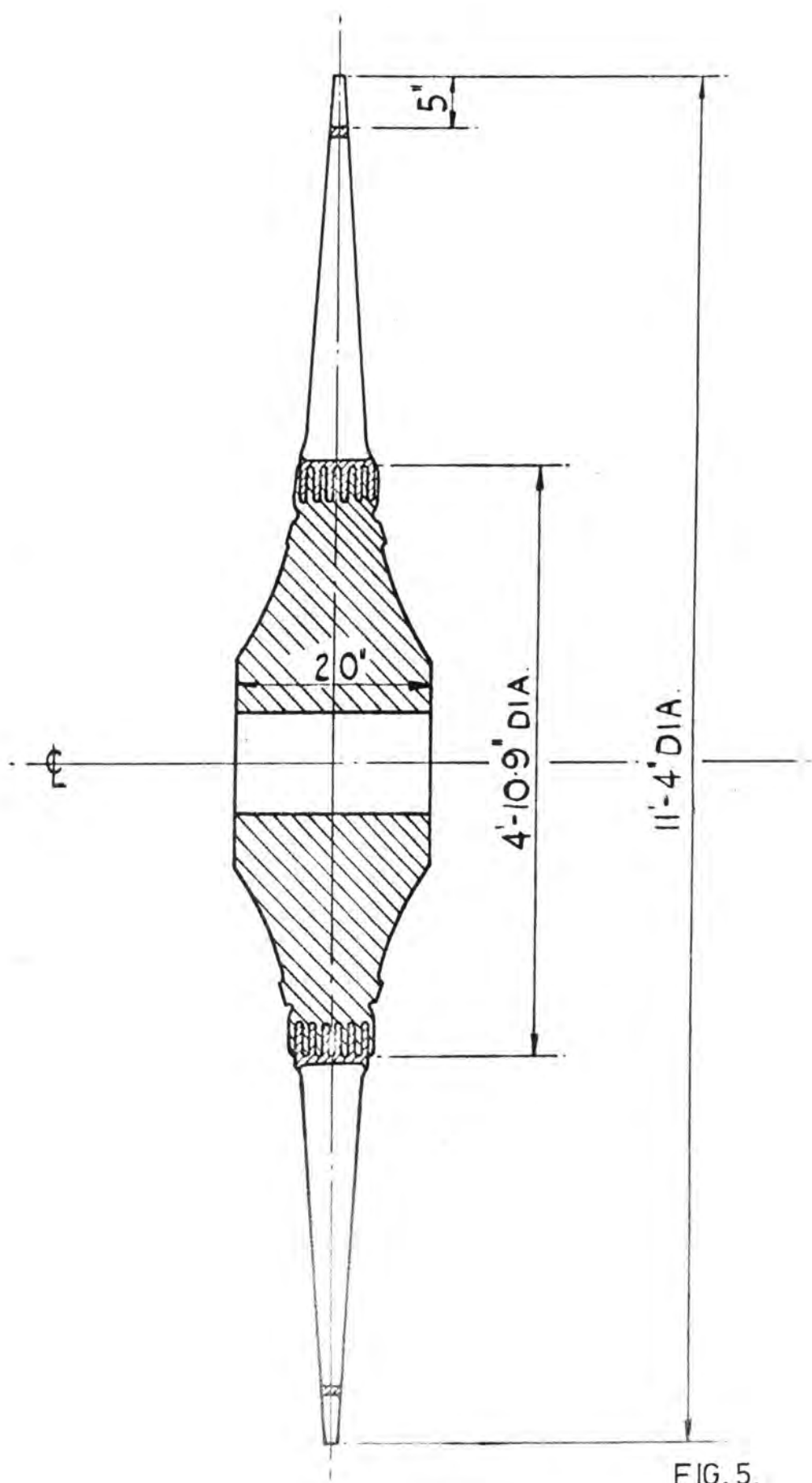



ARCH COVERBAND ASSEMBLY, TYPICAL OF MACHINE "B" (RIVITED
ROOT) LOW PRESSURE SETS

FIG.6.

CHAPTER IV

MEASUREMENT AND INTERPRETATION OF VIBRATION FREQUENCIES

4.0 Although the measurements of the vibration frequencies upon which the analysis in Chapters 5 and 6 is based were taken over a number of years, the method and instrumentation was the same throughout.

 From the point of view of behaviour under operating conditions, it is most important to ascertain the natural frequencies of turbine blades and wheels. This is done to prevent coincidence between natural frequencies and nozzle impulse frequencies and major critical speed. For this purpose vibration frequencies measured are of the fundamental tangential mode.

 An 'experimental' wheel is used for each type of machine to establish the correction required to static test results to account for rotational effects. Vibration measurements are also made on 'production' wheels to establish the frequency characteristics and to investigate whether they lie in the same range as those of the experimental wheel.

 Measurement of vibration frequencies on which the analysis is based took two main forms:

- (1) Static (i) Main blade frequencies
- (ii) Main wheel mode frequencies
- (2) Dynamic (i) Main blade frequencies
- (ii) Main wheel mode frequencies.

4.1 Method.

 For measuring frequencies of the natural modes of vibration of bladed wheels two main features have to be borne in mind:

- (a) a means of applying to the system an exciting alternating force of any given frequency;
- (b) a method of detecting the vibration response of the system to the given applied exciting force.

 These features apply to both static and dynamic measurements.

4.1.1 Equipment.

A block diagram of the apparatus used for static and dynamic vibration measurements is shown in Fig. 7. The equipment used is of standard design. A variable frequency oscillator is used as the source of the exciting signal, which may be applied by selector switches either to an amplifier which energises the stationary exciter magnet or to an exciting crystal on the wheel.

The signals received from the wheel pass into the in-phase rejector, where the level of extraneous vibration is reduced, and then through a variable filter, to be displayed on a cathode-ray screen. The signal magnitude can be read off from the meter. Signal frequencies can be measured using the calibrated oscillator, the signal from which may be applied to the cathode-ray tube Y-plates, either directly or as a triggered time-base. One-inch monitor tubes are used for continual display at various parts of the system and any one of these signals can be displayed on the larger monitor tube. Two counter units are included, one to measure and display rotational speed and the other to measure any selected oscillator frequency in the circuit. Piezo-electric crystal gauges can be used as a means of taking off signals when the crystal is strained or for applying a voltage for exciting purposes.

The equipment described above is mainly that used for dynamic tests but can be easily adapted for static tests. For a stationary wheel one of the simplest methods is to attach the armature of a moving coil exciter close to the root of a blade, energise it from a controlled variable frequency oscillator and detect the resonant frequencies by means of an electro-static proximity pick-up. It is advisable to work with a high sensitivity pick-up and low excitation rather than vice-versa. This enables the exciting device to be kept to a small size so that its attachment to the blade does not influence the natural frequencies of the system to any appreciable extent. As already discussed in Chapter 2, natural frequency of wheels and discs depends on the particular mode of vibration. There is a large number of possible modes. The results for up to 8 modes for experimental and production wheels for machines A and B

can be seen in Figs. 8 to 16.

Two methods are available for measuring blade vibration frequencies: one uses impact as a source of excitation, the other uses crystals. Since the latter method is expensive, it is only used to check measurements for experimental wheels. Experiments have shown that the difference in measurements resulting from the two methods are negligible.

Blades can vibrate in several different modes, *e.g.*: fundamental tangential, fundamental axial and fundamental torsional. Since the fundamental tangential mode has been found to be the most important in relation to performance, only this mode is measured in practice.

4.1.2 Dynamic test set up.

Measurements on rotating wheels are carried out on "Experimental" wheels. For this purpose the wheel is mounted on a short shaft which runs on two bearings inside a casing which can be sealed by means of a removable top half and evacuated to a high vacuum (See Fig. 41 in appendix). The wheel is driven by an electric motor through a shaft which passes through the casing and is connected to the removable shaft by a coupling. Slip rings of suitable diameter, designed for use with magnetic pick-ups, are built onto the driving shaft. Wheels can be rotated in this tester to well above 3000 rpm.

To prepare the wheel for rotation, the screened leads to the gauges are taken radially across the disc surface and glued firmly in position. The lead from the exciter is taken through the shaft coupling to the slip rings integral with the driving shaft and then to the output from a variable frequency oscillator. The indicator leads are taken through the centre of the shaft to a slip ring unit attached to the free end of the shaft. These slip rings are of conventional design for use with gauges, with silver plated rings $\frac{7}{8}$ inches diameter and silver morganite brushes. The signal is passed through a filter unit to an oscilloscope and the frequencies measured using a calibrated oscillator.

4.2 Interpretation of vibration frequency measurements

4.2.1 static tests.

The major interest here is in examining the relationship between static wheel frequencies and nodal diameters. The measured frequencies are studied in relation to the 3000 rpm impulse line and the likely occurrence of the critical modes can be seen from the graphs in Figs.8 to 16. Since frequencies are expected to increase under dynamic conditions, and those of the OD and ID mode are already above the impulse line, the 2D and 3D modes are those most likely to produce resonances.

The dynamic tests discussed below show that the 2D mode (Fig.19) is raised above the impulse line, and that modes above the 4D (Figs.21-23) are not lifted into the machine's running speed.

4.2.2 Dynamic tests.

Modes above 8D are not normally examined.

For ease of interpretation the results are plotted as frequency squared against speed of rotation squared. This procedure is followed both for wheels and for blades. Graphs Figs. 17 to 23 represent nodal patterns for dynamic wheel frequencies from zero to six nodal diameters and graphs Figs. 24 to 29 represent dynamic frequencies for six blades selected for study.

The purpose of plotting measurements in this form is two-fold: to use the graph to estimate Ks values and to examine whether the major and minor critical speeds occur near the running speed for the machine.

For wheel vibrations mode is identified according to the formula.

$$f_{EX}^2 = f_{p.u.}^2 + NR$$

where f_{EX} is the magnet excitation frequency in Hz.

$f_{p.u.}$ is the pick-up frequency from the rotating wheel in Hz.

R is the rotational speed in rev/sec.

N is the number of nodal diameters.

To illustrate the use of the graphs Fig. 20, representing the three nodal diameter mode, is selected for comment.

The three nodal diameter mode is excited and maintained, while speed increases from 0 to 3000 rpm. The corresponding vibration frequencies are plotted. The static frequency is derived from the intercept of the frequency axis with the curve formed by the frequency measurements. The value is found to be very close to that measured statically. The measured frequency curve appears to be discontinuous at 2000 rpm. The major critical speed (M) nearest to the running speed corresponds to the 3 ND upper and is at 3145 rpm. First minor is at 1930 rpm. The second major critical speed corresponds to the 3 ND lower and is at 2665 rpm and the first minor at 1820 rpm. The occurrence of two major and two minor critical speeds is due to the discontinuity of the curve of measured vibration frequencies, which is unusual, as can be seen from an inspection of the other graphs. The main conclusion to be drawn however is that both major and minor critical speeds will not coincide with the running speed.

To ascertain whether the wide range of fundamental blade frequencies measured statically (see Table 1) reduces with speed, six blades were selected to represent extreme and average values of frequency, and the vibration frequencies at 0 to 3000 rpm are plotted on graphs Figs. 24 to 29 (see also Table 6.3.1, Chapter 6). As was seen before, the fifth mode is likely to be critical. From the intersection of the measured frequencies curve with the fifth order line in Figs. 24 to 29 it can be seen that the corresponding speeds range from 2495 to 2565 rpm; here again one is able to conclude that these critical speeds will not coincide with the running speed. Table 6.3.3 in Chapter 6 shows that the range of fundamental blade frequencies did indeed reduce with speed. This is important since this range is used for calculating K_s values, and their accuracy is likely to be greater if the range is small.

4.3 Source of data.

The type of machine and the nature of the vibration tests on which the analysis of data in the next two chapters is based are shown in the two charts at the end of this chapter for ease of reference.

**BLOCK DIAGRAM OF APPARATUS
FOR STATIC AND DYNAMIC TESTS,**

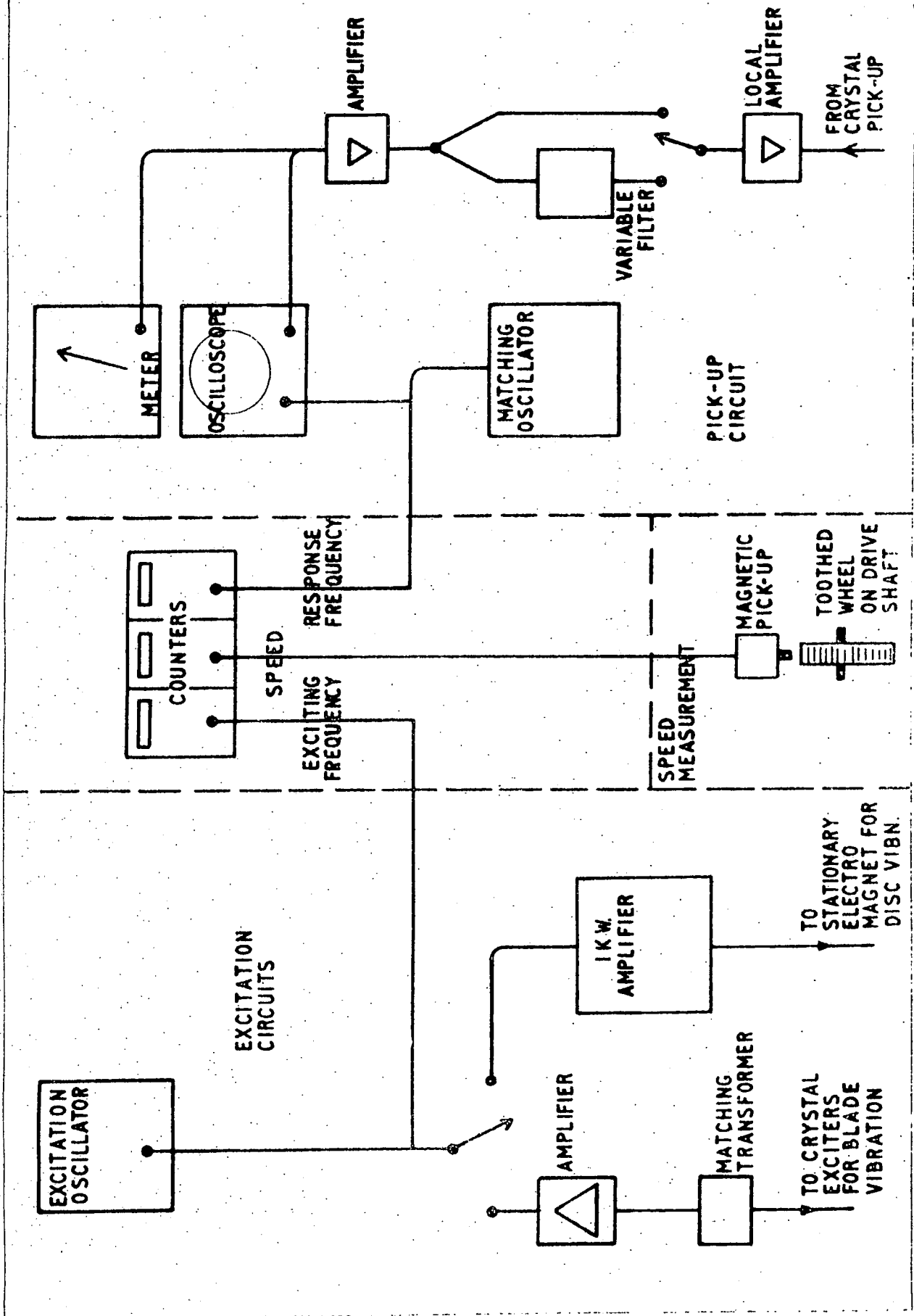

FIG. 7.

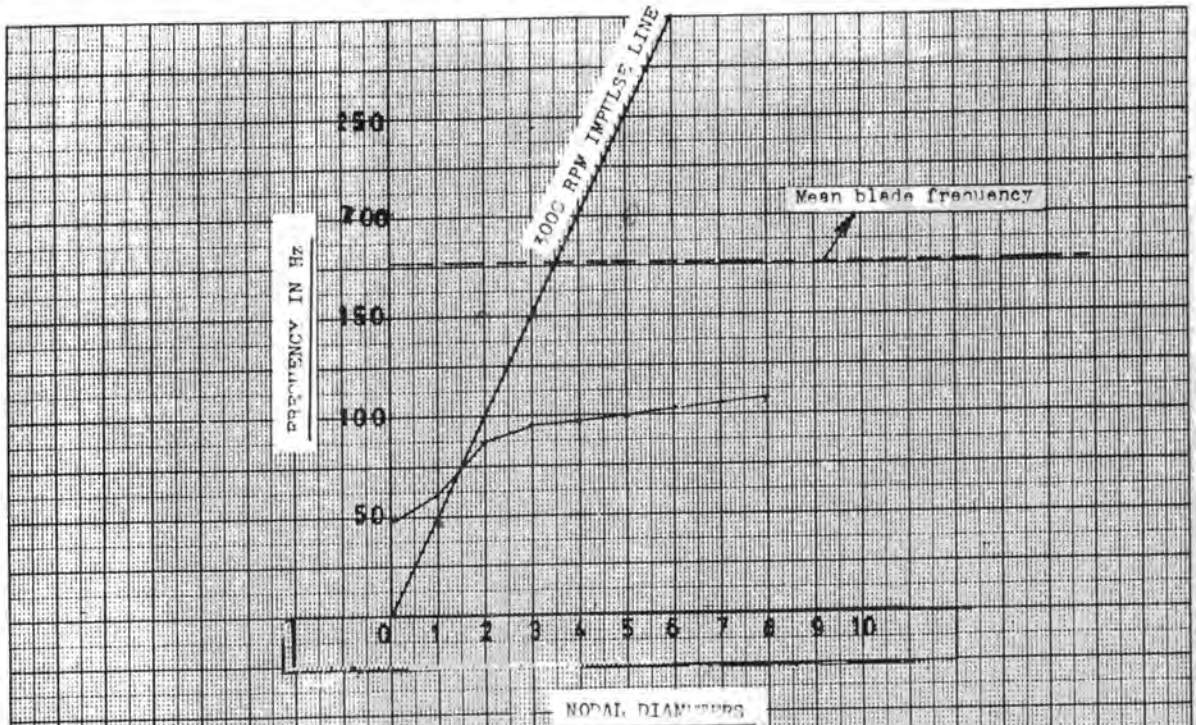

FIG. 8.

STATIC WHEEL FREQUENCIES vs NODAL DIAMETER FOR
EXPERIMENTAL WHEEL OF MACHINE "B" (RIVETED ROOT)

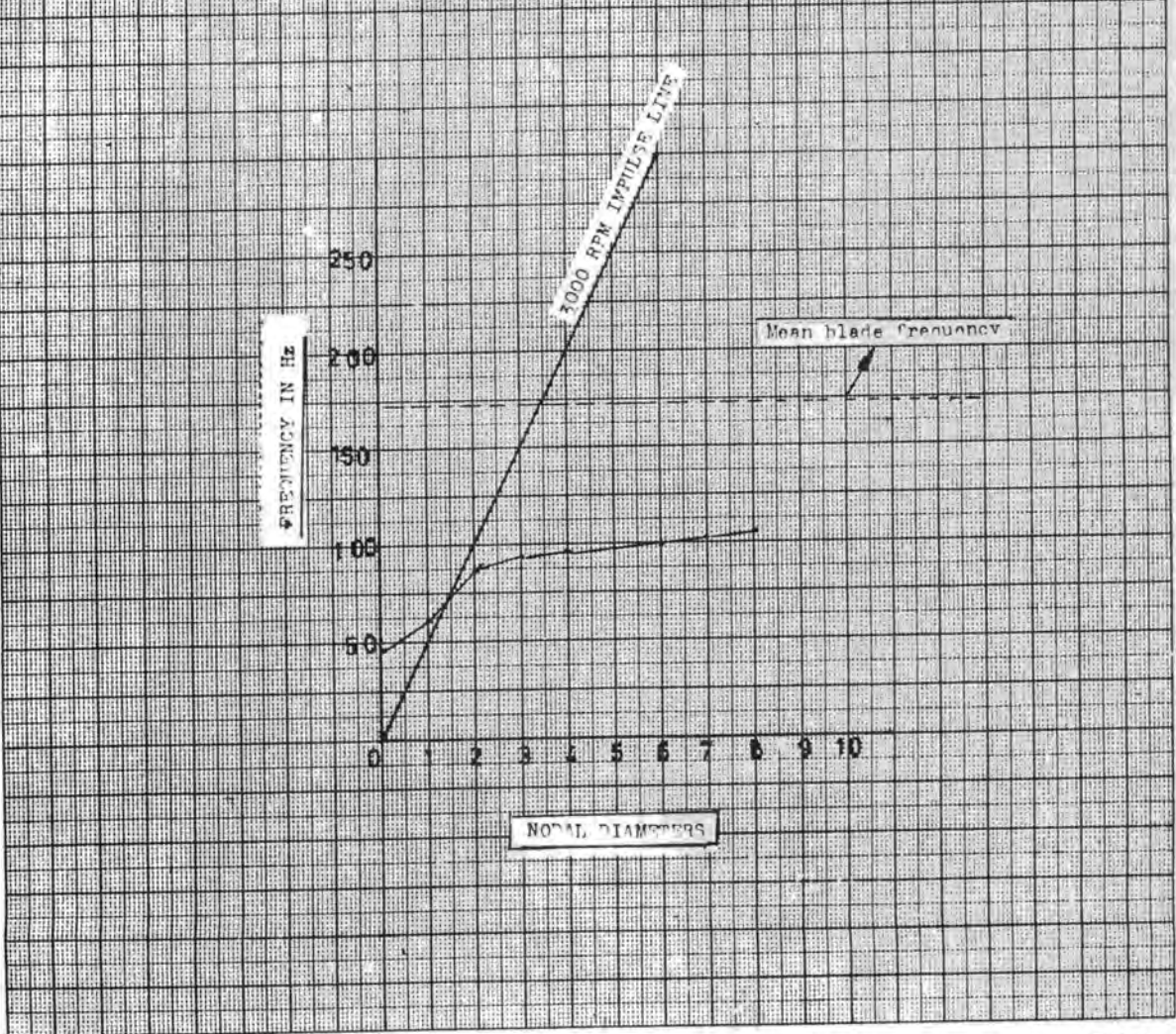

FIG. 9.

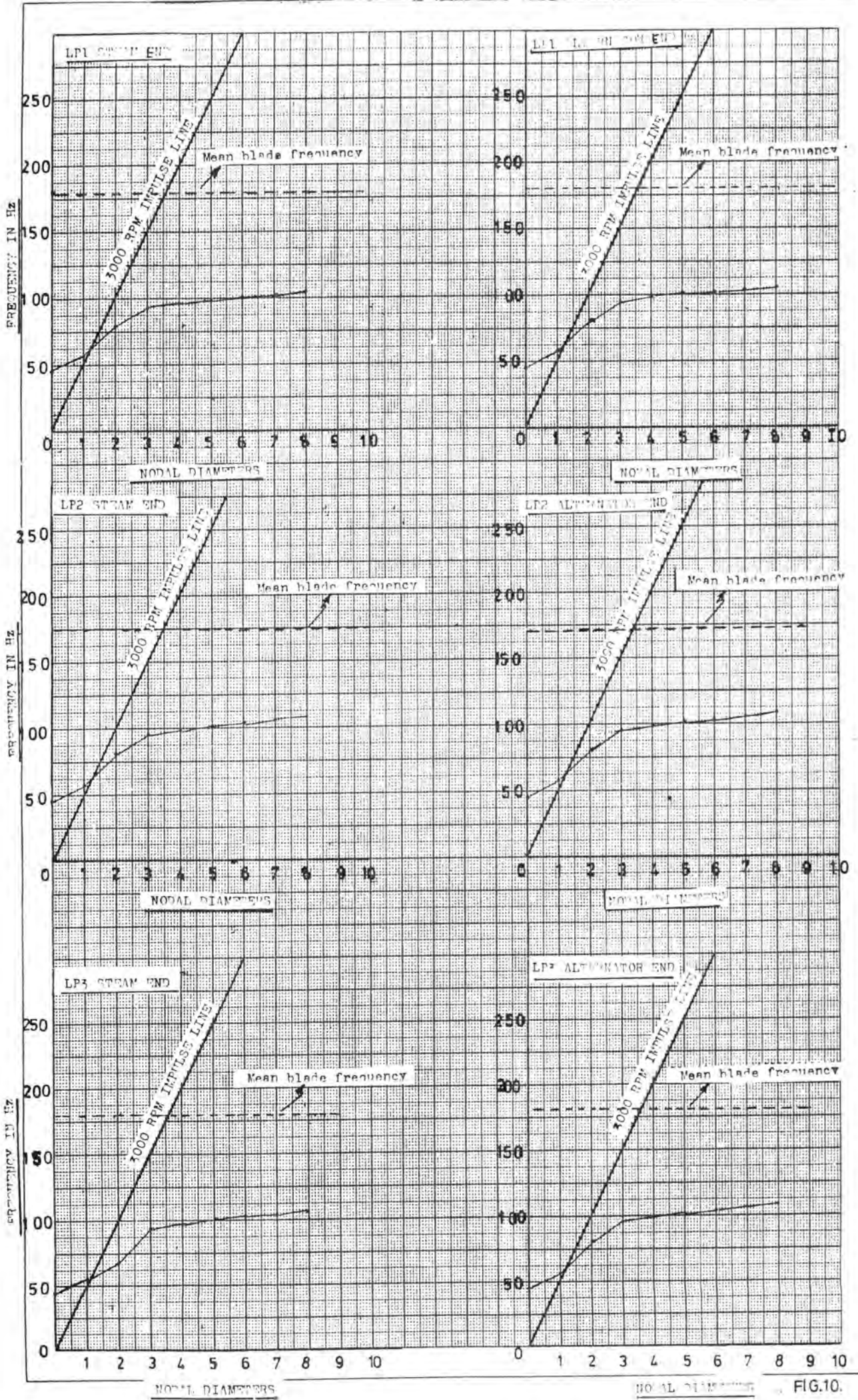

FIG.10.

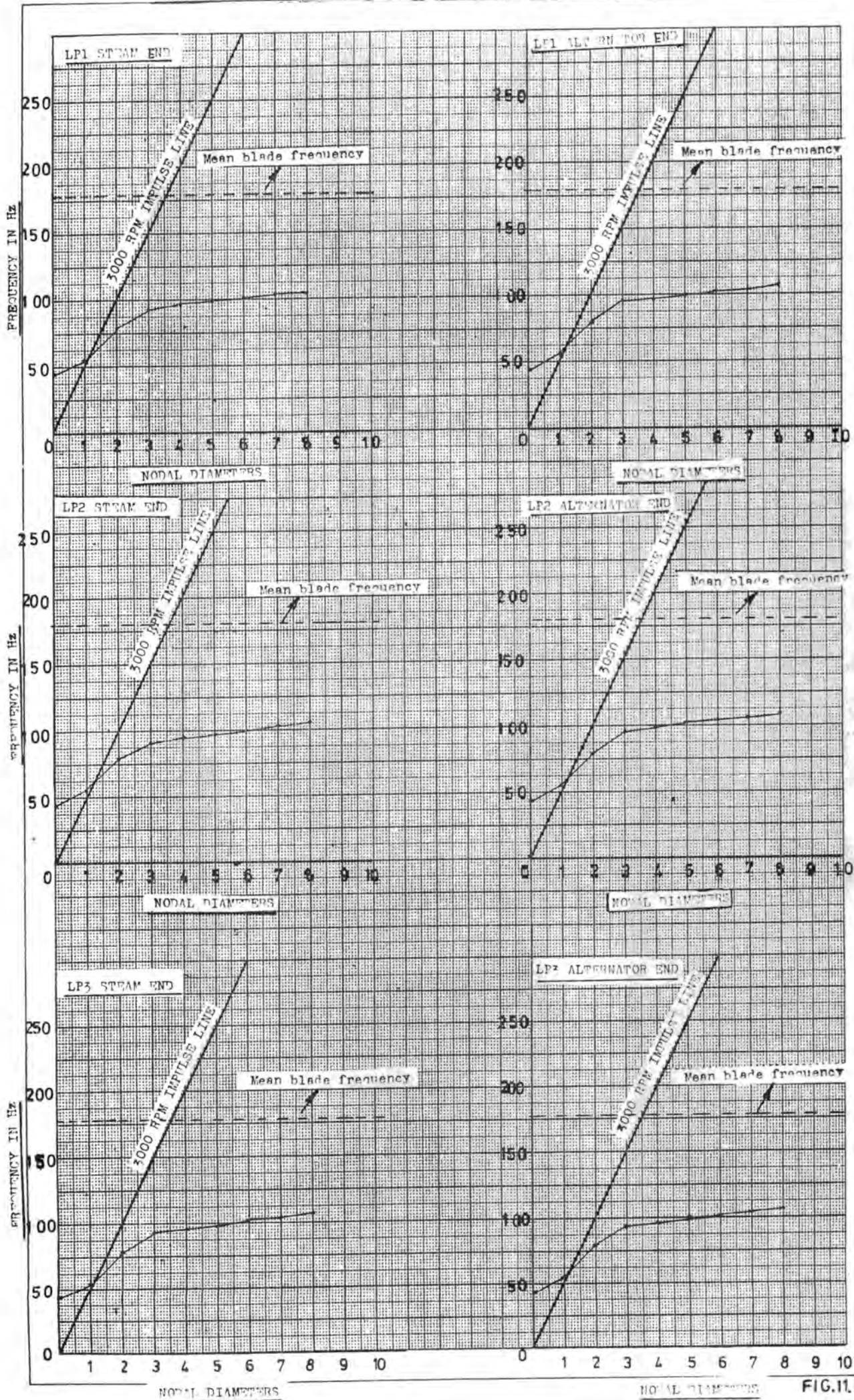

FIG.11.

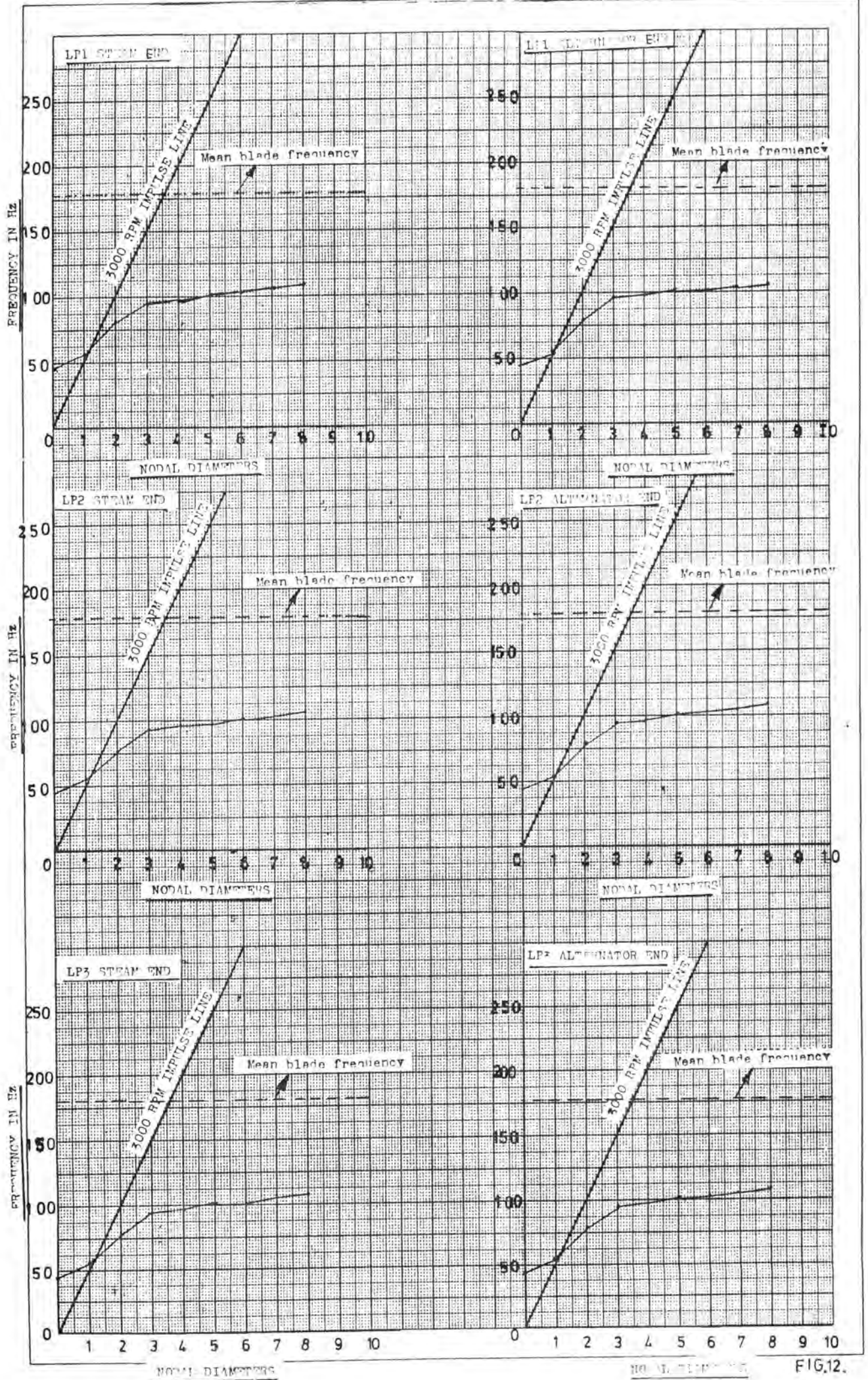

FIG.12.

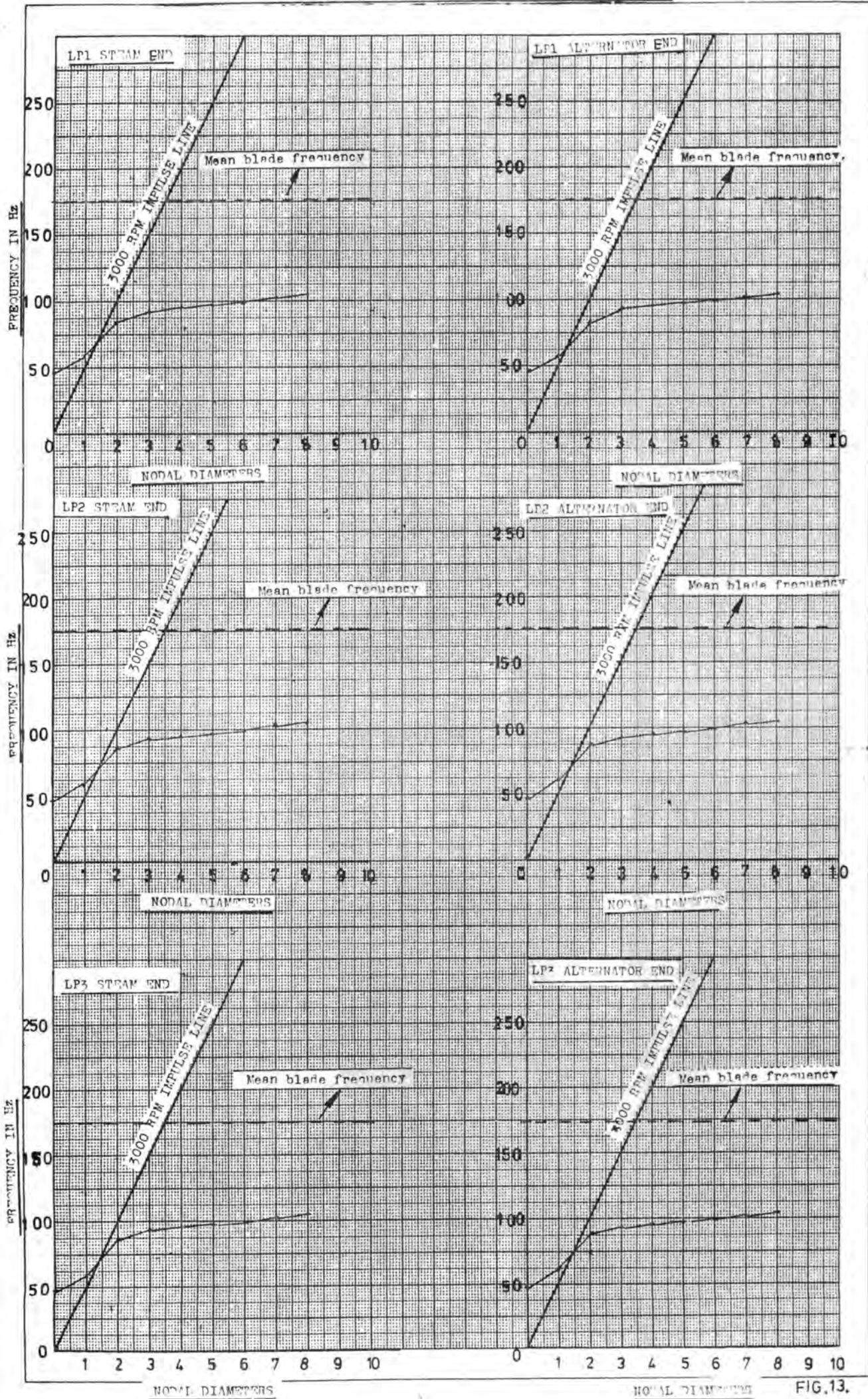

FIG.13.

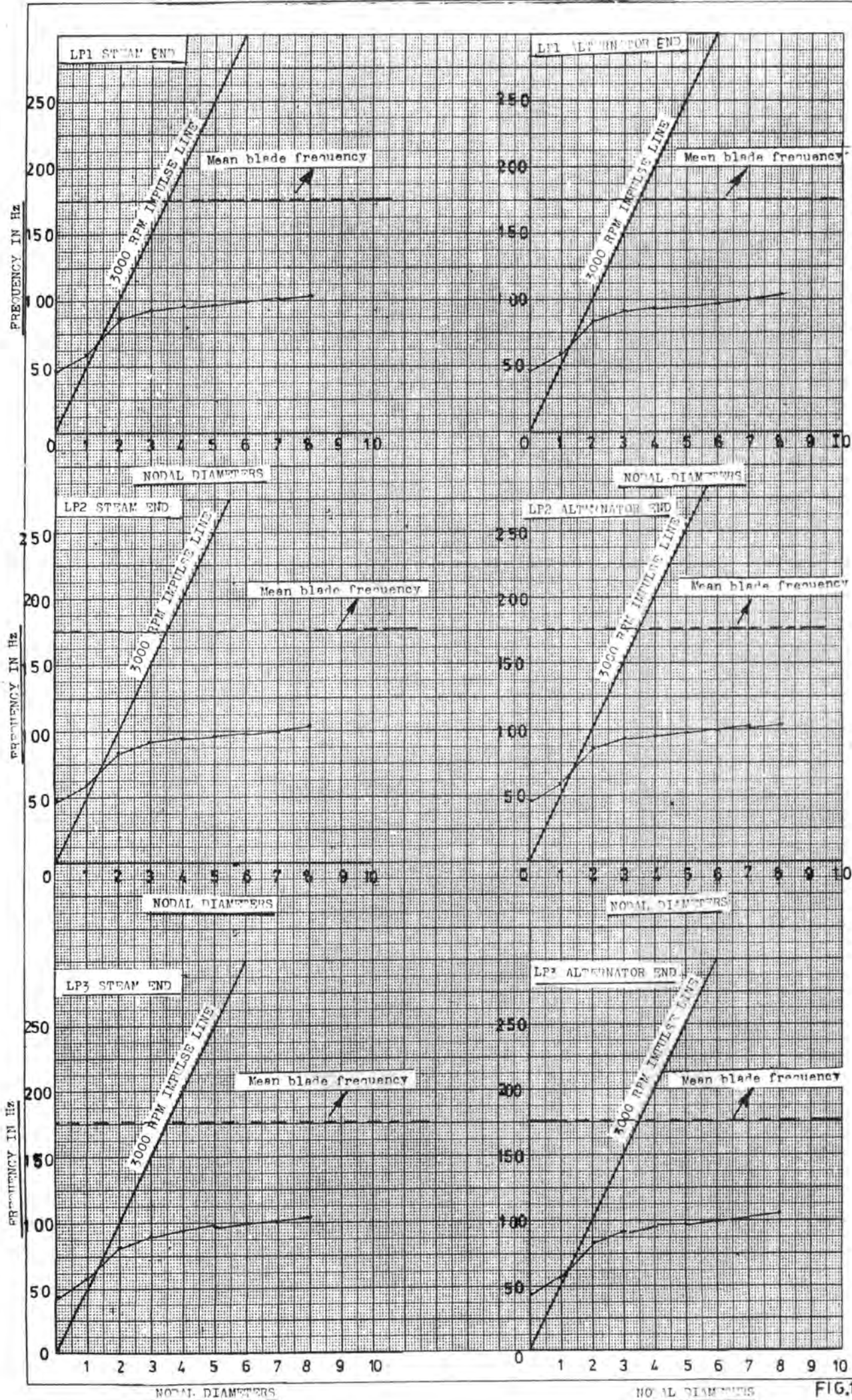

FIG.14.

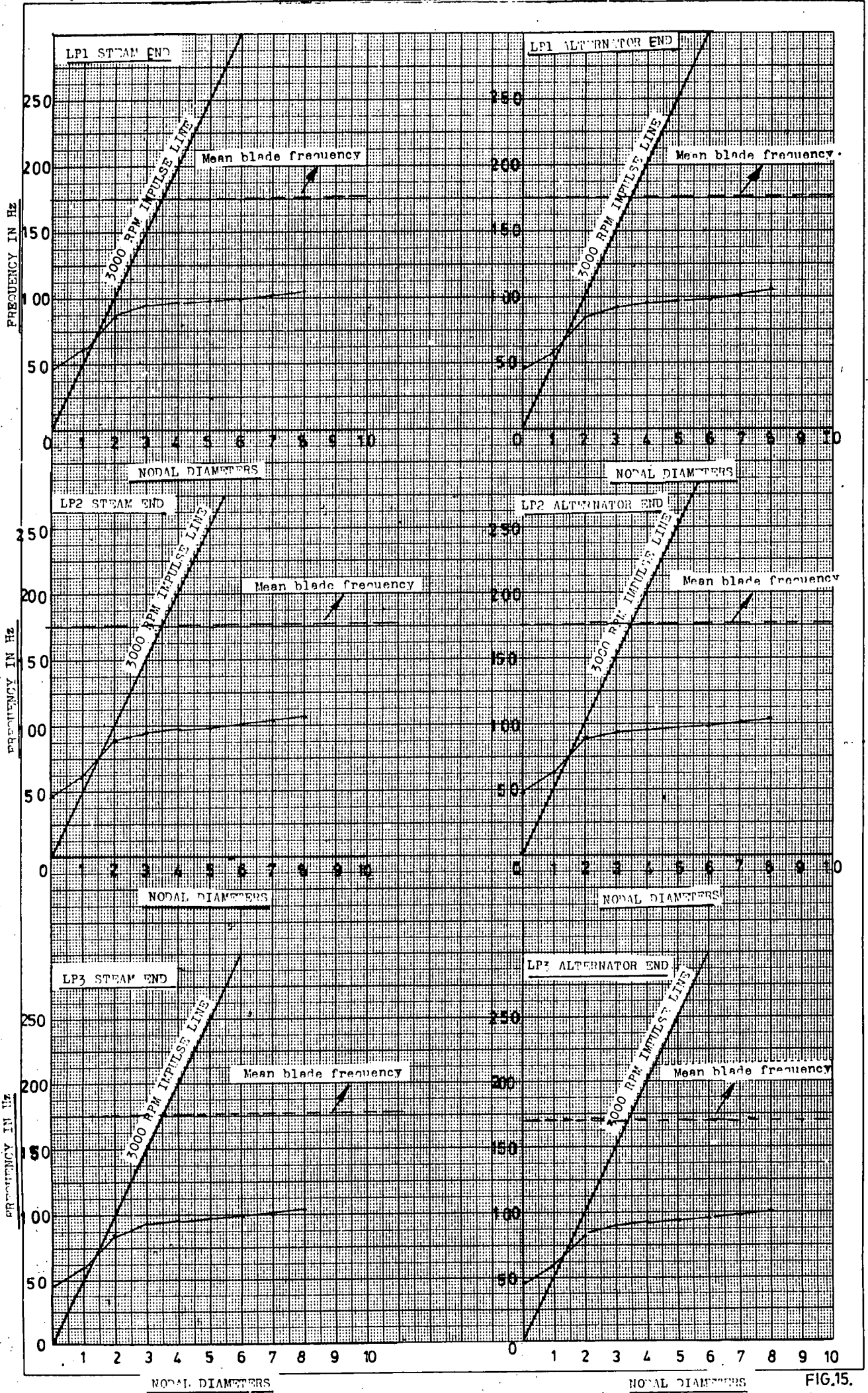

FIG.15.

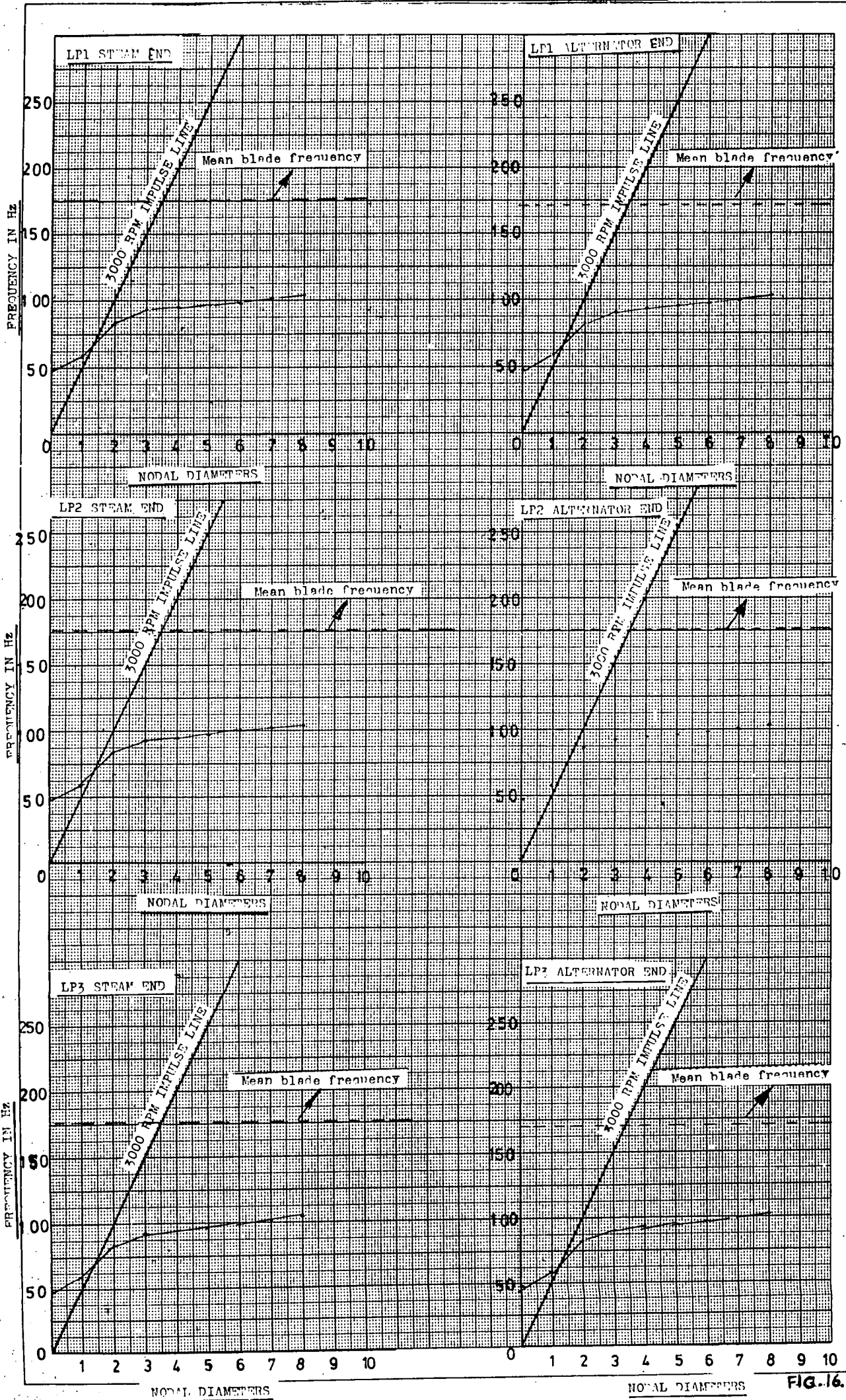

FIG. 16.

DYNAMIC WHEEL FREQUENCY f^2 VS ROTATIONAL SPEED R^2
 FOR EXPERIMENTAL WHEEL OF MACHINE "A" (FIRST-RED ROOT)

O - NODAL DIAMETERS.

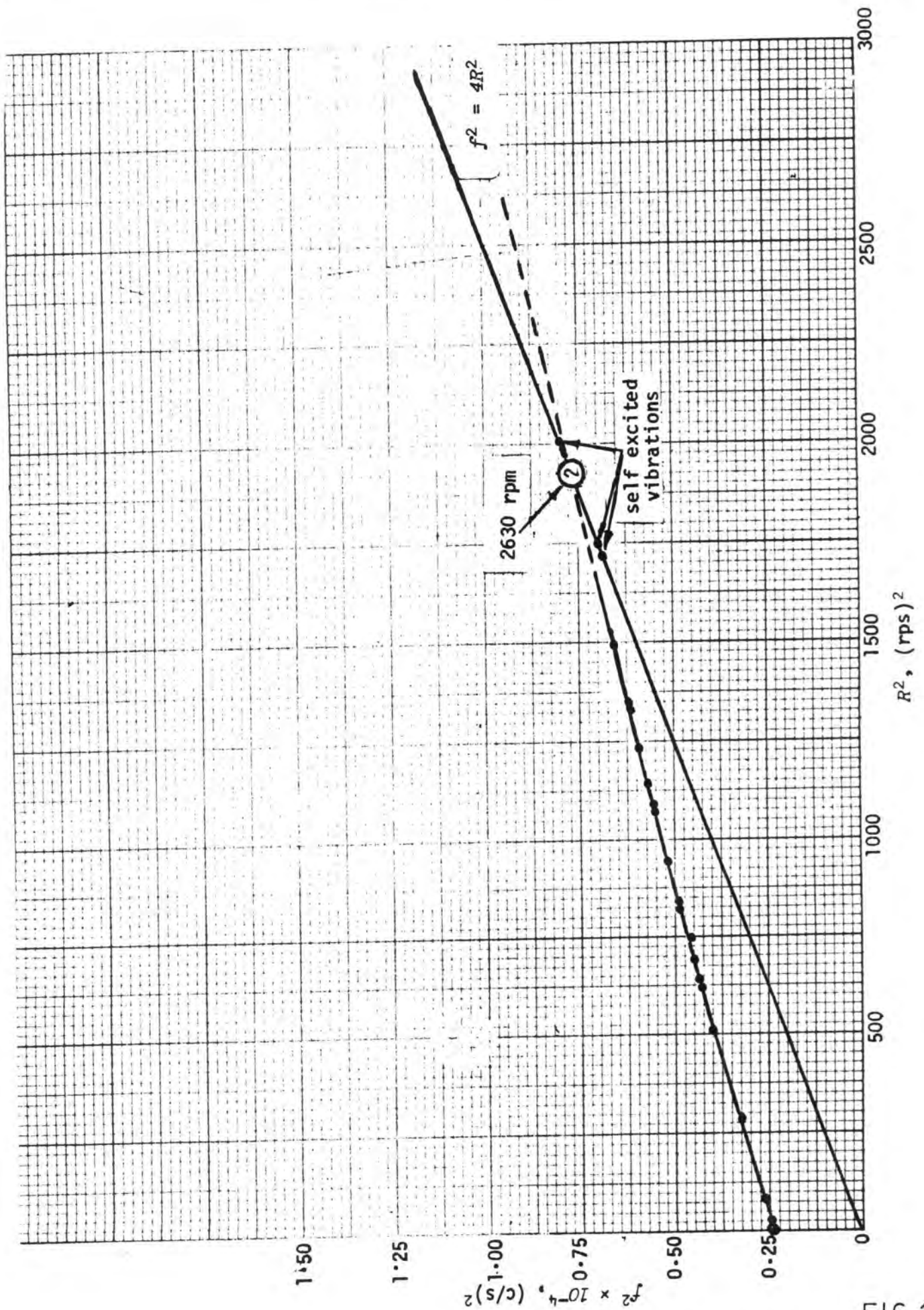

FIG. 17.

1 - NODAL DIAMETERS

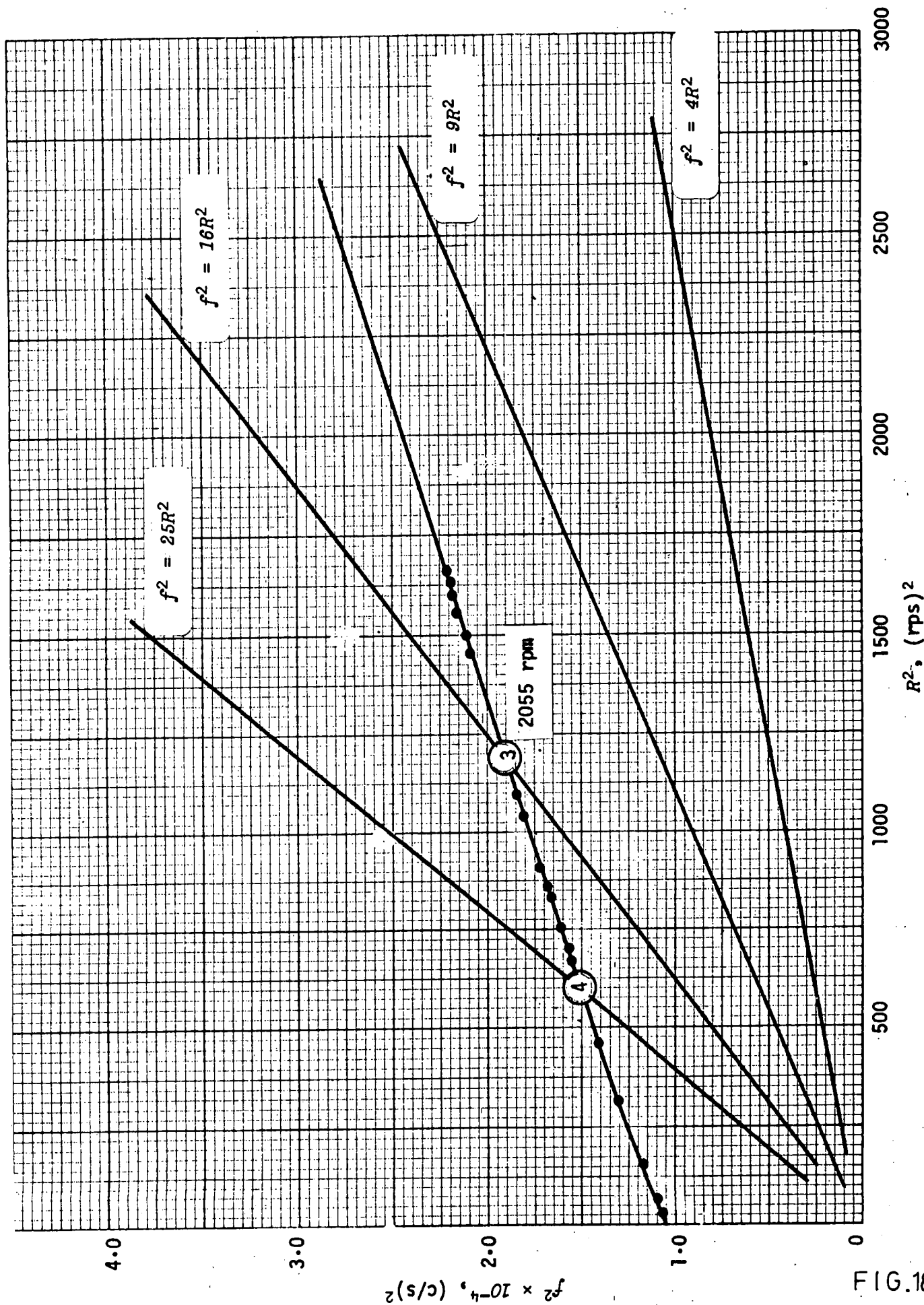

FIG. 18.

DYNAMIC WHEEL FREQUENCY f^2 VS ROTATIONAL SPEED R^2
FOR EXPERIMENTAL WHEEL OF MACHINE "A" (FIR TREE ROOT)

2 - NODAL DIAMETERS

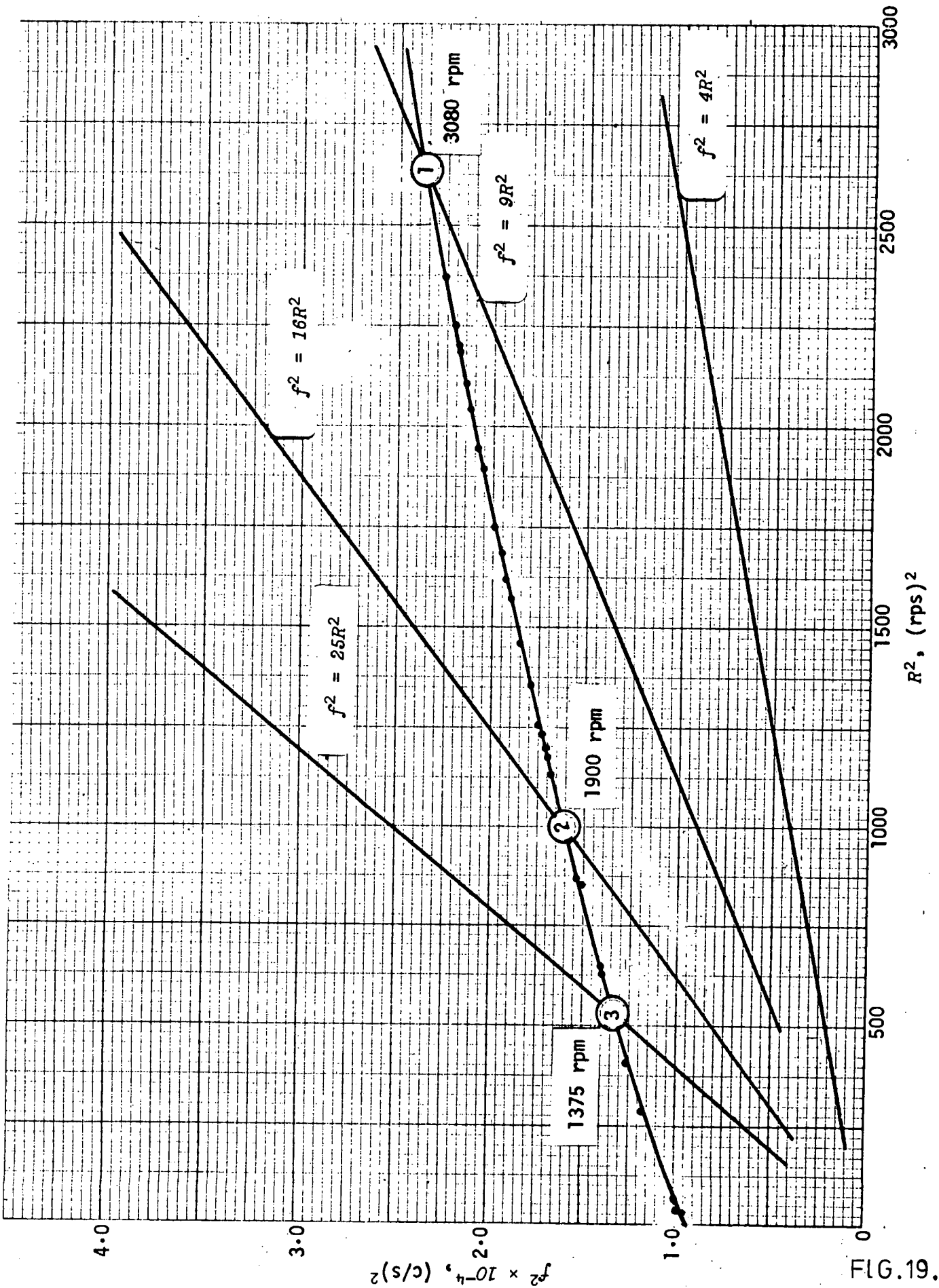

FIG. 19.

DYNAMIC WHEEL FREQUENCY f^2 Vs ROTATIONAL SPEED R^2
 FOR EXPERIMENTAL WHEEL OF MACHINE "A" (FIRTREE ROOT)

3 - NODAL DIAMETERS

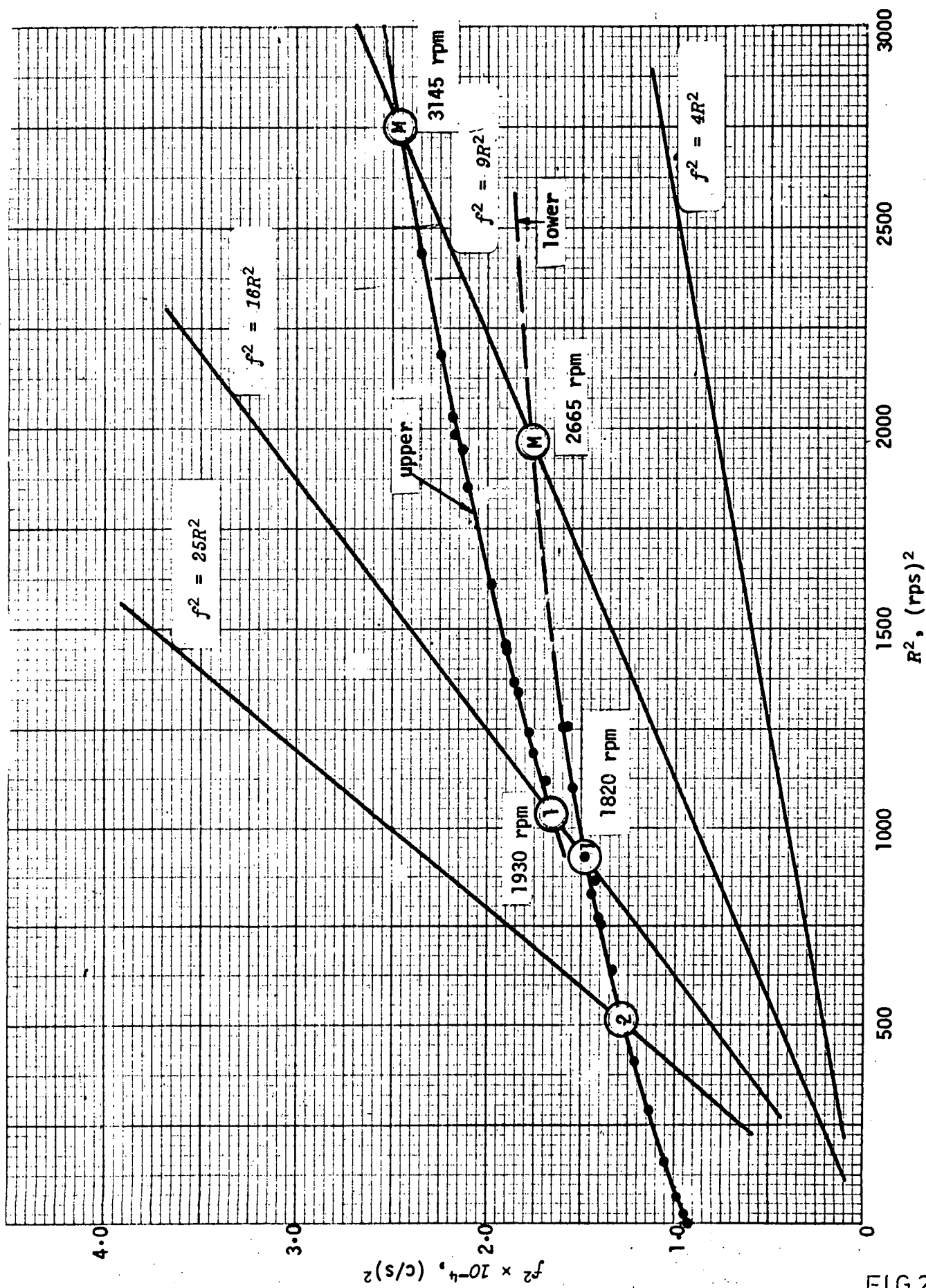

FIG.20.

FOR EXPERIMENTAL WHEEL OF MACHINE "A" (FIR TREE ROOT)

4 - NODAL DIAMETERS

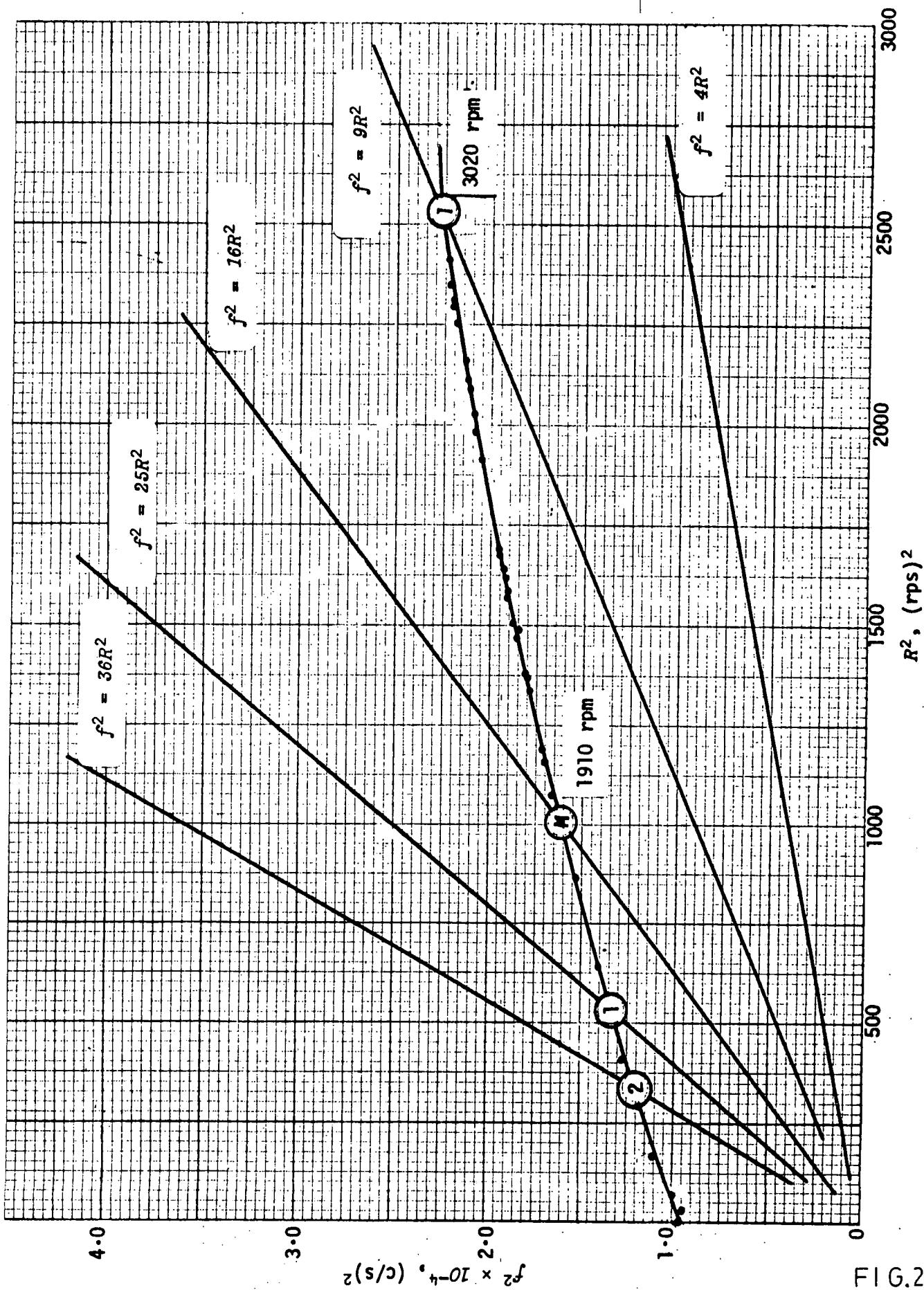

FIG. 21.

DYNAMIC WHEEL FREQUENCY f^2 Vs ROTATIONAL SPEED R^2
 FOR EXPERIMENTAL WHEEL OF MACHINE "A" (FIR TREE ROOT)

5 - NODAL DIAMETERS

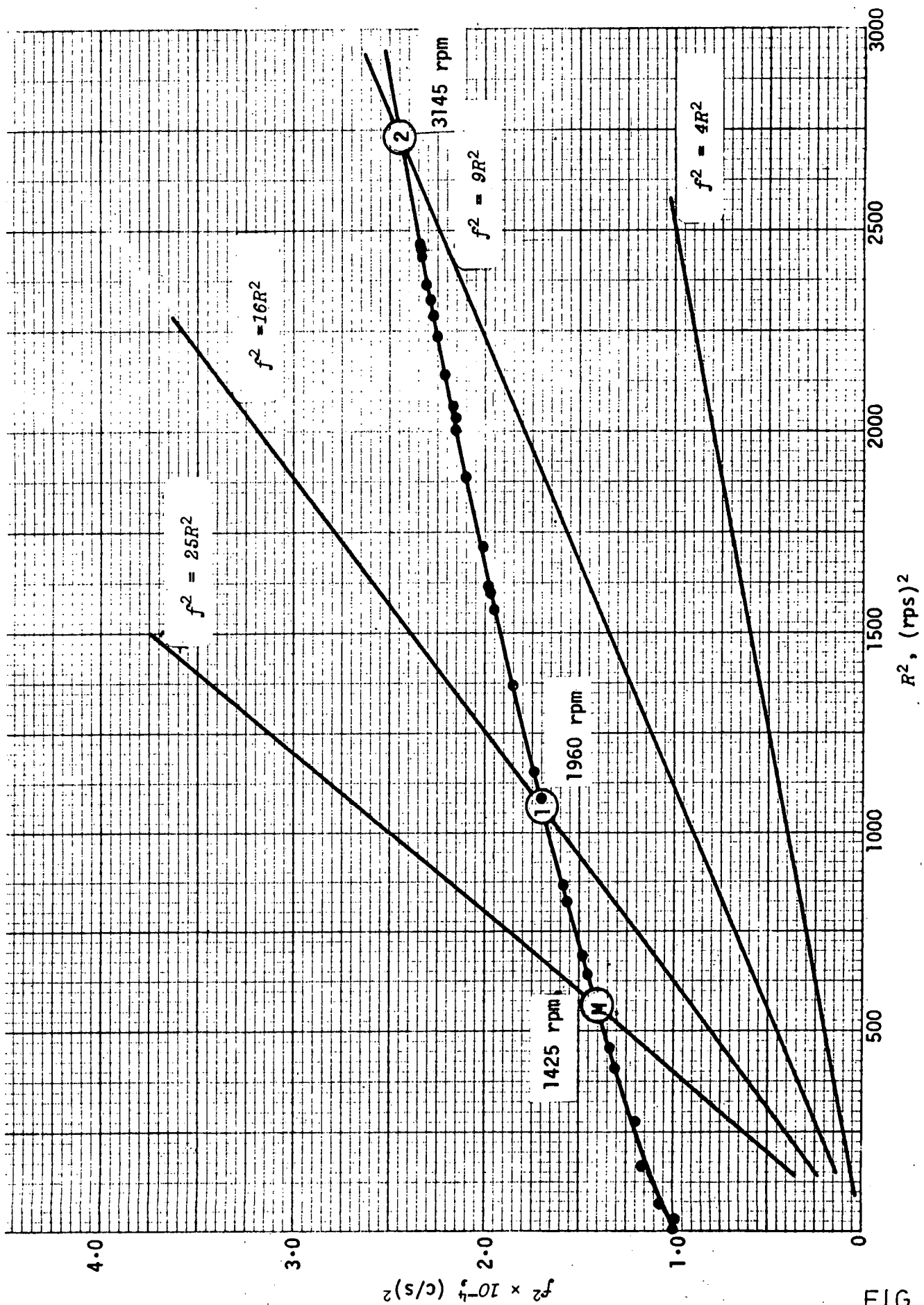

FIG. 22.

DYNAMIC WHEEL FREQUENCY f^2 Vs ROTATIONAL SPEED R^2
 FOR EXPERIMENTAL WHEEL OF MACHINE "A" (FIRTREE ROOT)

6 - NODAL DIAMETERS

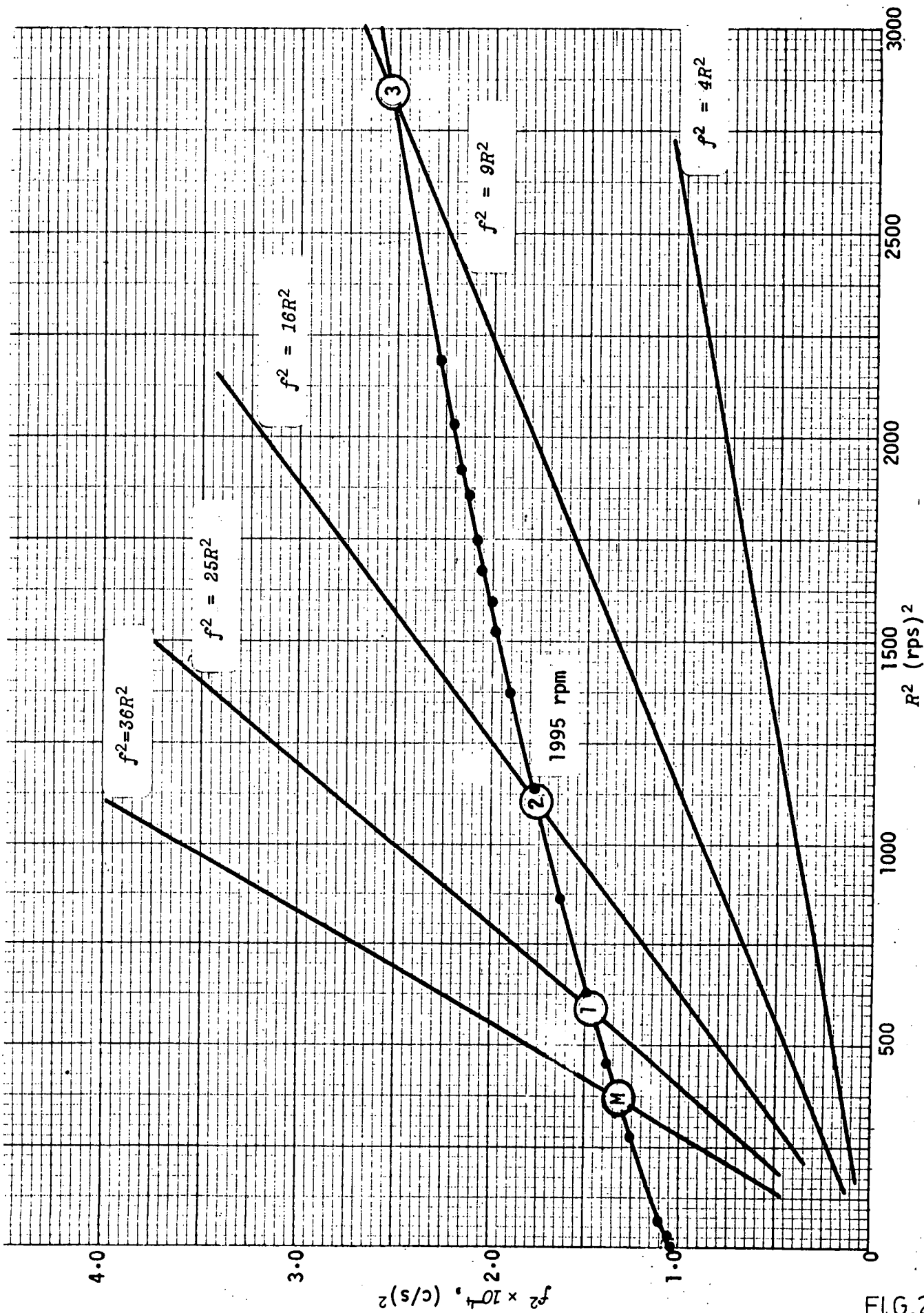

FIG.23.

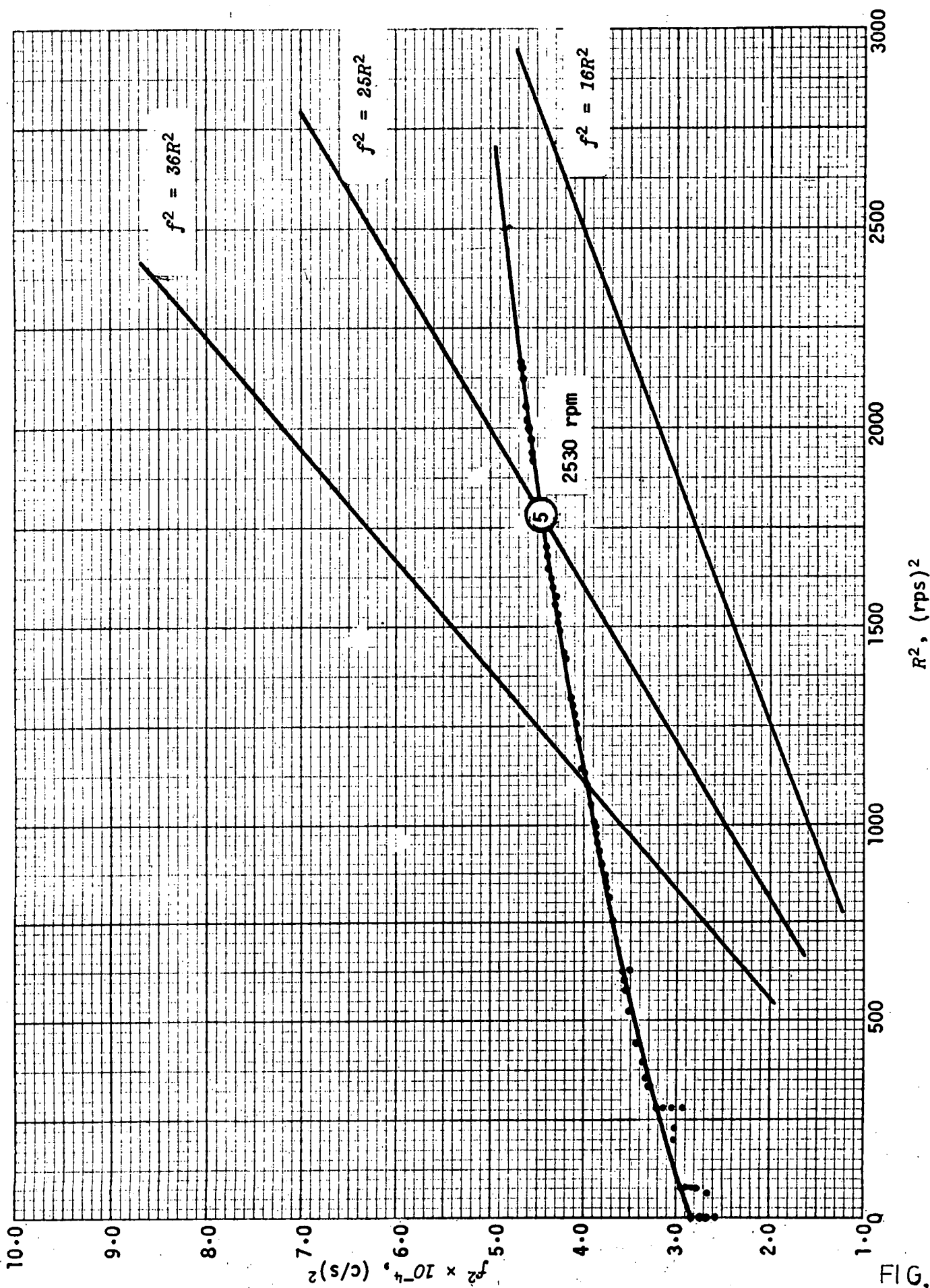

FIG. 24.

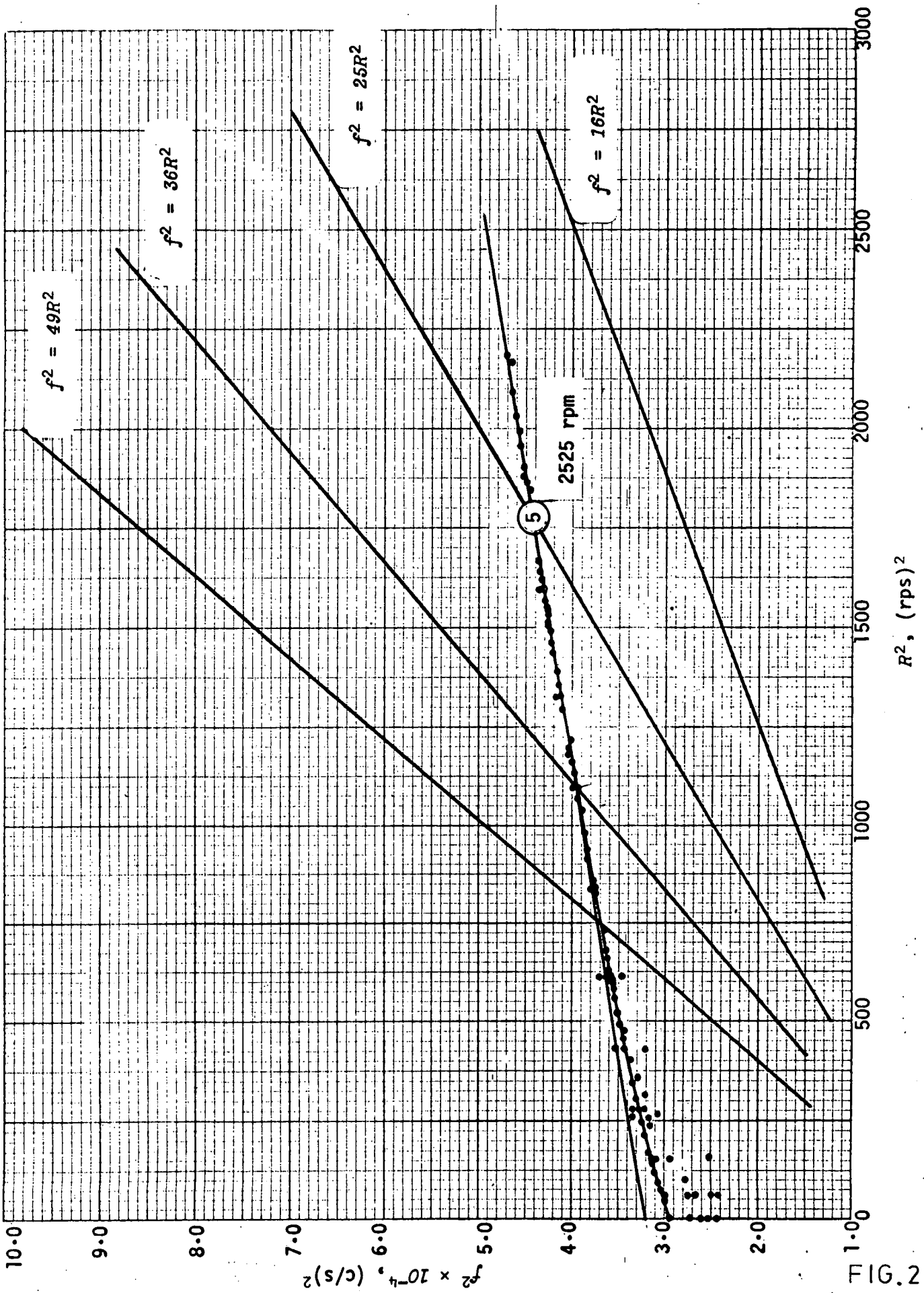

FIG. 25.

MAIN FREQUENCY f^2 OF BLADE NO. 27 OF EXPERIMENTAL WHEEL
 OF MACHINE "A" (FIR TREE ROOT) VS ROTATIONAL SPEED R^2

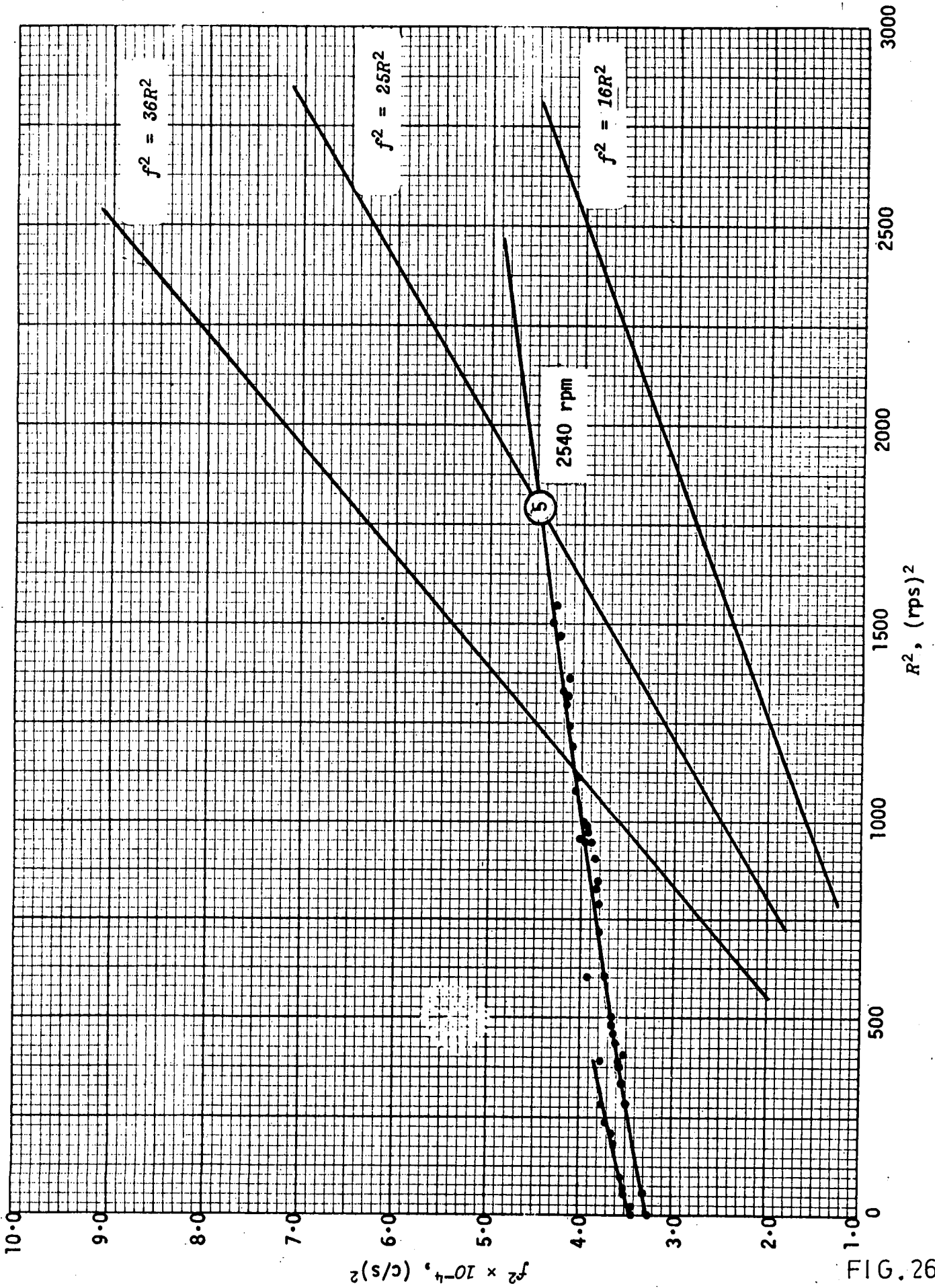

FIG. 26.

MAIN FREQUENCY f^2 OF BLADE NO. 62 OF EXPERIMENTAL WHEEL
OF MACHINE "A" (FIR TREE ROOT) VS ROTATIONAL SPEED R^2

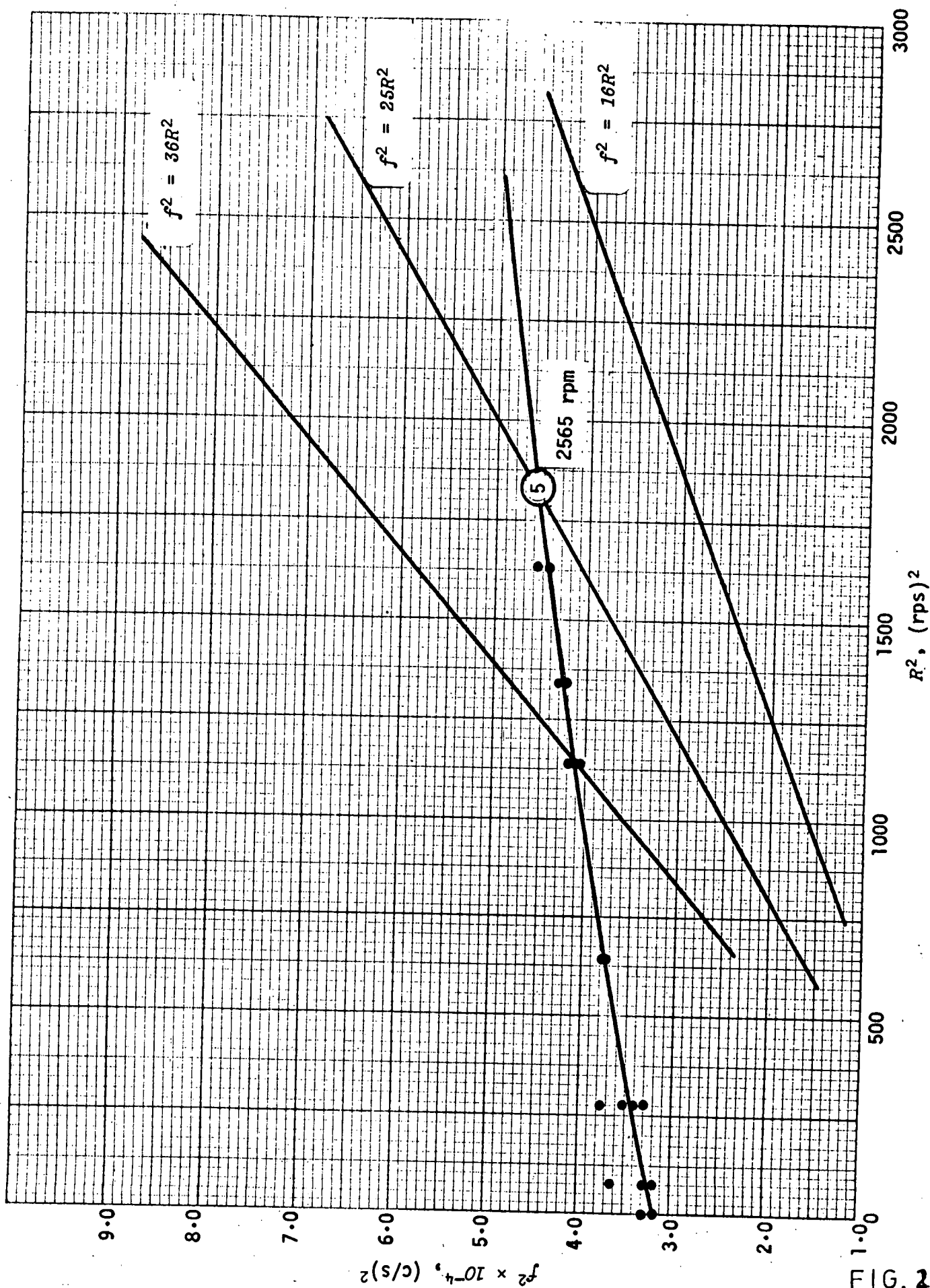

FIG. 27.

MAIN FREQUENCY f^2 OF BLADE NO. 64 OF EXPERIMENTAL WHEEL
 OF MACHINE "A" (FIR TREE ROOT) Vs ROTATIONAL SPEED R^2

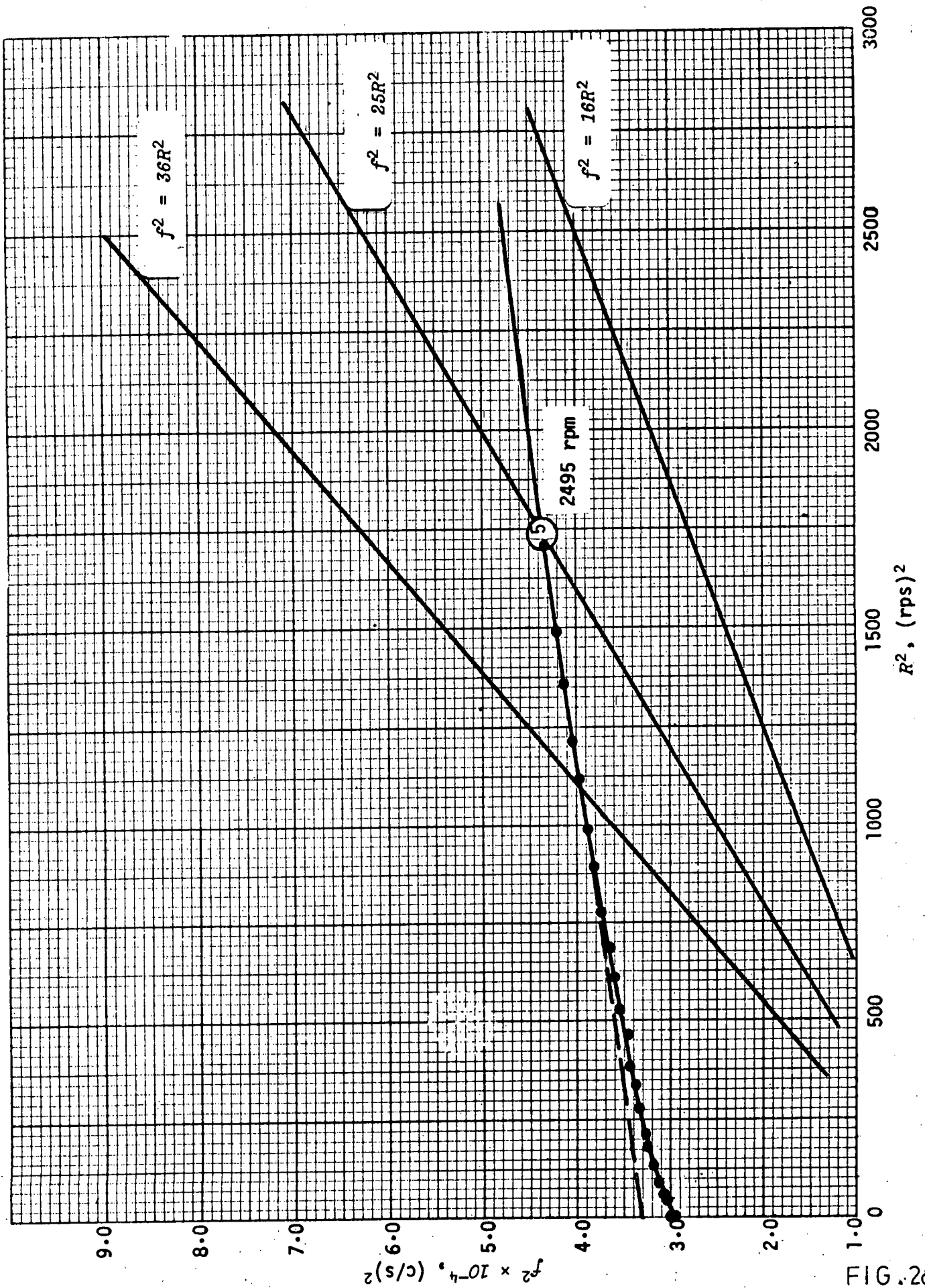

FIG. 28.

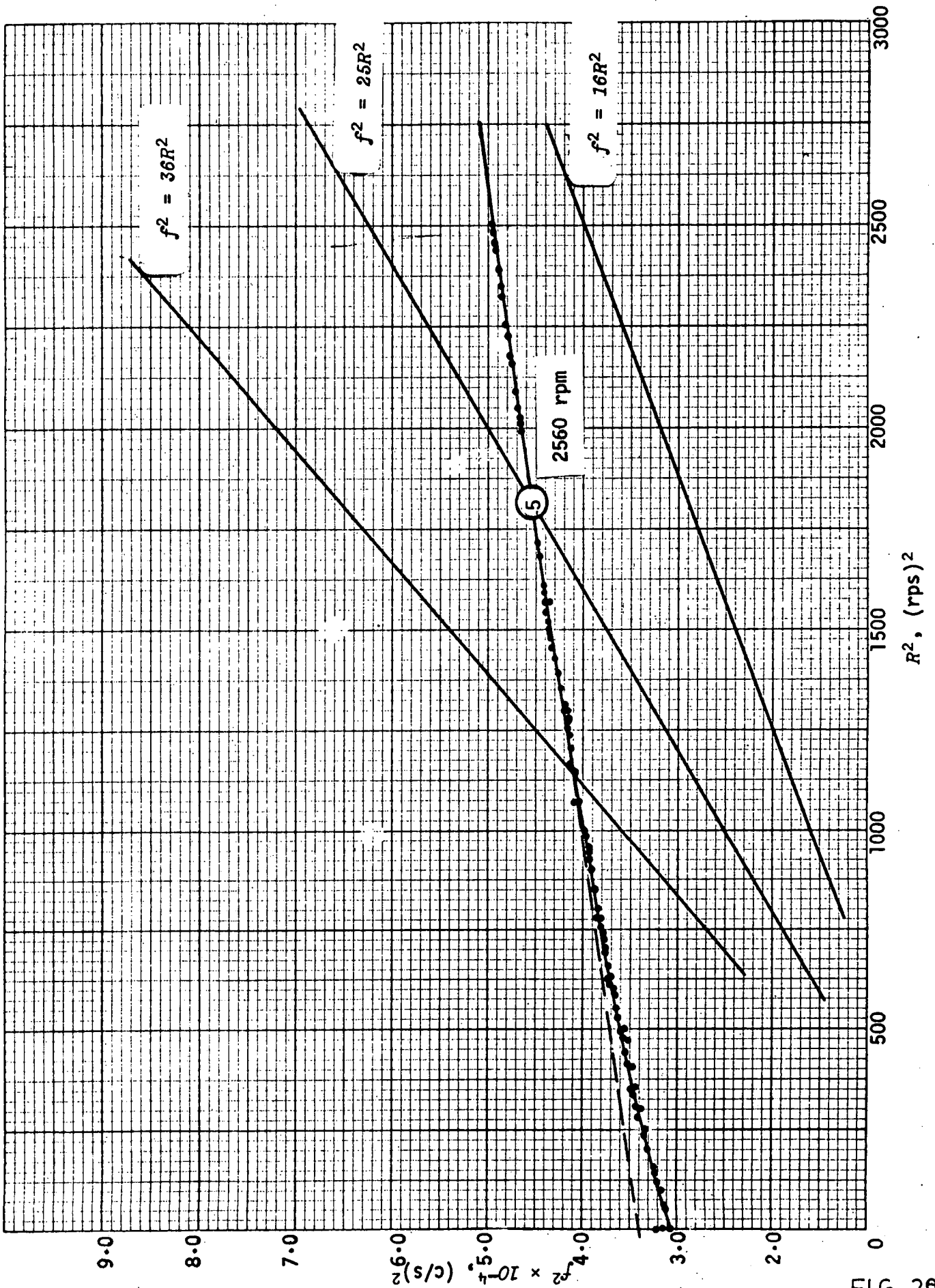

FIG. 29.

CHART SHOWING SOURCES OF DATA

LP STEAM TURBINE MACHINE A (FIRTREE ROOT)

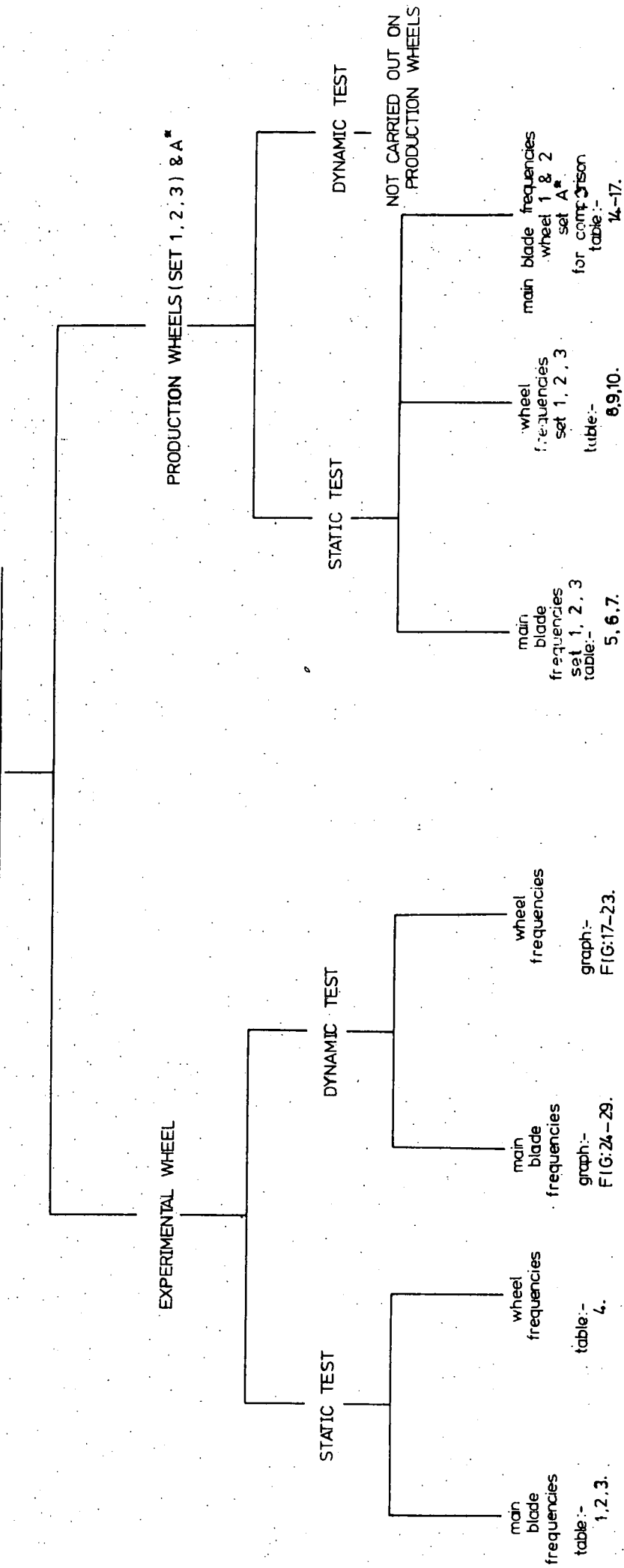

FIG. 30.

CHART SHOWING SOURCES OF DATA
 L.P. STEAM TURBINE MACHINE "B" (RIVETED ROOT)

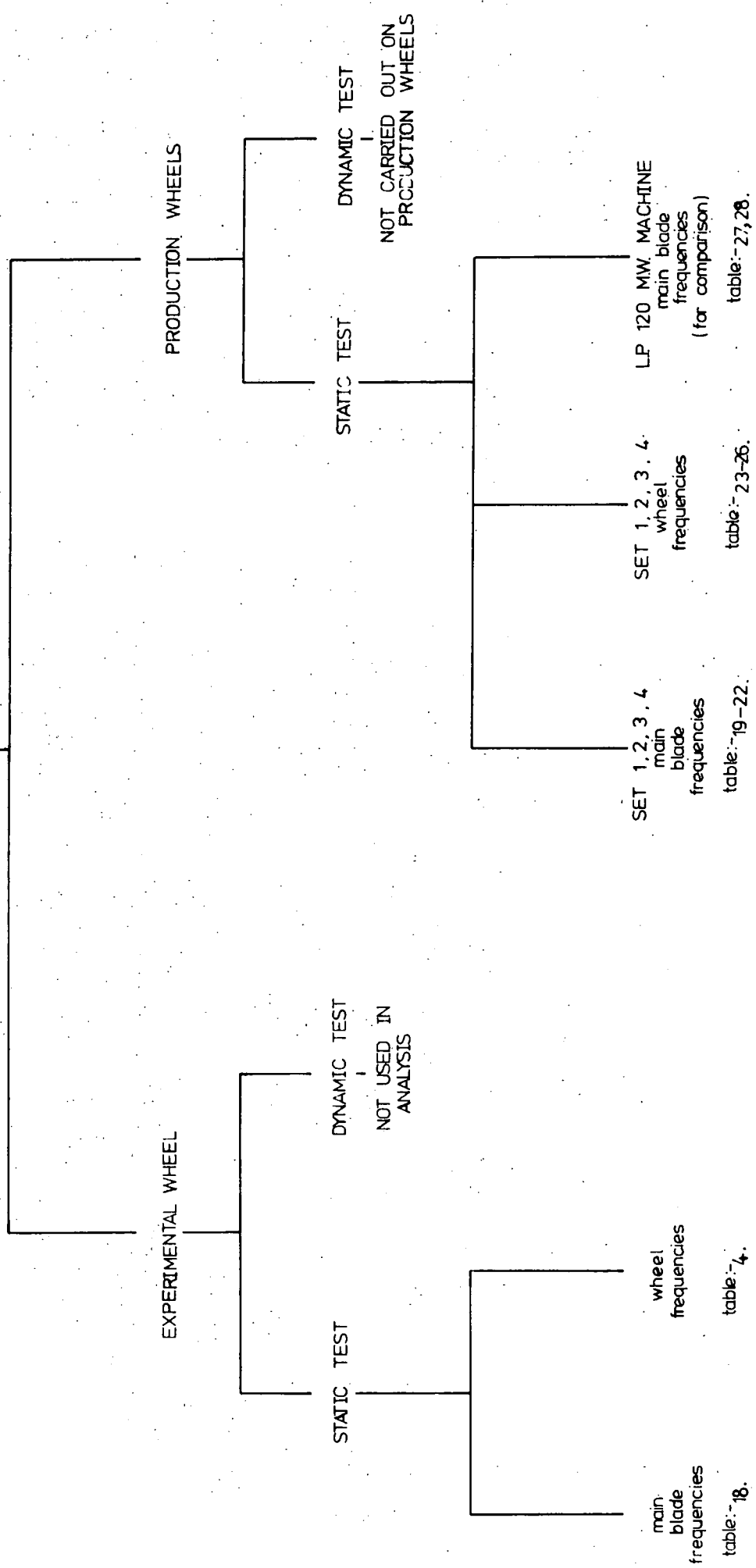

FIG. 31.

CHAPTER V
DISTRIBUTION PARAMETERS OF STEAM TURBINE
BLADES AND WHEEL VIBRATION MEASUREMENTS

5.0 It will have been seen from Chapter 3 that modern power stations require ever larger turbines which must, however, perform as reliably as the smaller ones which have stood the test of time. The design of turbine wheels has received considerable attention. The main design features are the geometry of the blade, the root fixation and end fixation. It was decided to study two types of wheels which differ only in root fixation; a minor difference in geometry related to root fixation was found not to have any marked effect on measured frequencies. In fact vibration tests have been carried out to determine the changes which occur in frequency as the dimension of the root is reduced from .96 to .85 inches. The results show that changes in frequency are small.

Production wheels and blades are subjected to static vibration tests as a matter of routine and any anomalies which may be observed are reported upon. The measurements for each wheel tend to be considered separately and compared mainly with those of an experimental wheel of the same type. If one considers that on average only some three to four wheels of this size are tested in any year, it will be appreciated that comparative data could be of value in studying the behaviour of a particular wheel.

It was decided therefore to take data from tests carried out on the two types of machine over some ten years and to subject them to statistical analysis. This would give a more concise picture of the distribution of measurements and could, perhaps, provide useful information for comparative purposes.

The analysis took 4 main forms:

- (i) A study of static blade vibration measurements for production wheels (Sets 1, 2, 3) of machine "A" (firtree root) and production wheels (Sets 1, 2, 3, 4) of machine "B" (riveted root);

- (ii) A study of static wheel mode vibration measurements for the same sets of the above machines;
- (iii) A study of static wheel mode vibration measurements for Stage 5 for the above machines (for comparative purposes) as indicated in the introduction;
- (iv) The distribution characteristics of machine "A" and machine "B".

Before subjecting the data to statistical tests a sample selected at random from the readings for each type of machine was tested for normality and was found to meet the criteria. (see p. 66a).

5.1 Static blade vibration measurements

Static blade vibration measurements for three sets of machine "A" (fir-tree root) were selected for analysis. Each set consists of six wheels and each wheel contains 96 blades (see Tables 5, 6, 7 in the Appendix). Needless to say, it is assumed that production wheels meet design criteria within specified tolerances. Since the main concern of the present study was to examine the effect, if any, of different root fixation, it was decided to treat blades as "identical" and to consider the 96 blade vibration measurements as repeated vibration measurements of the same wheel. The data were therefore subjected to a one-way analysis of variance to test the assumption that there is no difference between wheels. Since the largest sample (a sample here corresponds to the readings for one wheel) mean is less than 50% greater than the smallest, it was possible to make the assumption that the data are additive. Although sample variances are not equal, differences are small, and the analysis of variance can still give adequate results (Alder, H.L., and Roessler, E.B., 1968 Introduction to Probability and Statistics. 4th edition. San Francisco and London: W.H. Freeman and Company). Means, range and standard deviation for each of the 18 wheels are set out in Table 5.1.1.

TEST OF THE HYPOTHESIS THAT THE LP TURBINE BLADE VIBRATION
FREQUENCY MEASUREMENTS USED IN THIS STUDY ARE NORMALLY DISTRIBUTED.

The Chi-square test of 'goodness of fit' was used on a sample of blade vibration frequency measurements consisting of the following wheels. Experimental Wheels for Machines A and B and production wheels from each type of machine, selected at random from the sets of 18 and 24 respectively.

<u>Wheel</u>	<u>Reference</u>	<u>χ^2</u>	<u>d.f.</u>	<u>χ^2 at p .05</u>	<u>Decision</u>
Experimental 'A'	Table 1, p.141 and p. 100	6.60	3	7.82	Accept hypothesis of normal distribution
Production 'A'	Table 5.1.1. p.87 Set I(5)	3.15	1	3.84	"
Production 'A'	Table 5.1.1 p.87 Set II (12)	7.71	3	7.82	"
Production 'A'	Table 5.1.1 p.87 Set III (14)	6.00	2	5.99	Cannot reject hypothesis of normal distribution
Experimental 'B'	Table 18 p.158 and p. 100	.40	1	3.84	Accept hypothesis of normal distribution
Production 'B'	Table 5.1.2 p.88 Set I (3)	.53	1	3.84	"
Production 'B'	Table 5.1.2 p.88 Set I (5)	2.16	1	3.84	"
Production 'B'	Table 5.1.2 p.88 Set II (12)	2.27	1	3.84	"
Production 'B'	Table 5.1.2 p.88 Set III (17)	.77	1	3.84	"

Although the blade vibration frequency measurements for Machine B give a closer agreement with the hypothesis of normal distribution than those for Machine A, the latter are still within the acceptance range of the hypothesis. In any event, with large samples deviations from normality have only a negligible effect on the 't' and 'F' tests, particularly if, as in the problem under investigation, these tests are sensitive enough to show up differences which are relevant from an engineering point of view. (cf. G. Barrie Wetherill, Elementary Statistical Methods, Methuen, 1967, p. 143).

TABLE 5.1.1

MEANS, RANGE AND STANDARD DEVIATIONS FOR BLADE VIBRATION MEASUREMENTS IN Hz
FOR EACH OF THE 18 WHEELS FOR MACHINE "A" (FIRTREE ROOT)

Wheel number	SET I									SET II									SET III								
	1	2	3	4	5	6	7	8	9	10	11	12	13	14	15	16	17	18									
Mean \bar{x}	179.48	180.31	174.60	173.48	179.84	181.01	178.85	180.59	181.70	181.81	174.73	177.89	178.75	179.01	181.69	178.76	178.40	176.16									
Range	168.2	169.3	145.9	143.0	173.8	175.6	160.5	175.2	174.9	168.9	158.1	168.4	172.6	167.2	178.9	161.2	140.0	150.8									
Standard deviation (sd)	2.77	2.58	9.69	9.49	2.04	2.19	4.09	1.73	1.91	3.36	6.40	4.44	2.85	3.30	1.59	5.22	8.16	7.73									

TABLE 5.1.2.
 MEANS, RANGE AND STANDARD DEVIATIONS FOR BLADE VIBRATION MEASUREMENT IN HZ
 FOR EACH OF THE 24 WHEELS FOR MACHINE 'B' (RIVETED ROOF).

Wheel Number	SET I						SET II						SET III						SET IV					
	1	2	3	4	5	6	7	8	9	10	11	12	13	14	15	16	17	18	19	20	21	22	23	24
Mean \bar{x}	175.50	175.47	176.53	175.90	174.48	174.64	176.58	175.26	175.61	175.37	175.47	175.90	174.86	175.33	176.33	176.43	176.53	172.12	175.61	173.62	175.00	175.19	175.03	172.82
Range	172.5	173.1	174.5	173.9	172.6	172.0	173.2	173.1	172.5	173.3	172.0	173.1	173.4	173.4	174.8	175.0	174.0	169.9	173.0	172.0	173.2	173.4	173.4	171.0
Standard deviation (sd)	0.89	1.13	0.93	1.03	1.06	0.99	1.18	1.31	1.63	1.37	1.77	1.41	0.63	1.11	0.72	0.55	1.13	1.01	0.83	1.32	1.12	0.69	0.88	0.87

One-way Analysis of Variance Table N = 96
 (See Tables 5 to 7 in the Appendix) g = 18

<u>Source of Variance</u>	<u>c.s.s.</u>	<u>d.f.</u>	<u>M.S.</u>	<u>F</u>
Between wheels	10380.90	17	610.64	
Within wheels	45513.72	1710	26.61	22.94
Total	55894.62	1727		

Similarly for machine "B" vibration measurements for four sets were subjected to analysis (see Tables 19, 20, 21, 22 in the Appendix). Means, range and standard deviation for each of the 24 wheels are set out in Table 5.1.2

One-way Analysis of Variance Table N = 90
 (See Tables 19 to 22 in the Appendix) g = 24

<u>Source of Variance</u>	<u>c.s.s.</u>	<u>d.f.</u>	<u>M.S.</u>	<u>F</u>
Between wheels	2579.33	23	112.14	91.01
Within wheels	2632.08	2136	1.23	
Total	5211.42	2159		

If one examines the Analysis of Variance Tables for Machine A and Machine B respectively (see also Tables 5.1.1, and 5.1.2), it may be said that the decision to consider blade vibration measurements as repeated measurements on the same wheel was not unjustified. The mean square for the residual source of variance in each case is of a relatively very low magnitude. The value of F, however, indicates that there are statistically significant differences between the wheels of Machines A and B respectively. Since Machine "B" has been in operation for over nine years it does not seem likely that the statistically significant difference found between wheels can be translated directly into a significant difference in engineering terms. It could be argued that the statistical test selected is too refined and powerful, given the dimensions of the wheels on the one hand (with an 11 feet diameter and weighing some 20 tons each) and the precision of static vibration measurements of blades (see Chapter 4) on the other. However, this is not to deny that differences between the wheels exist, but they are still within the tolerances stipulated in the design. It

was felt that since sets were manufactured in different years, a separate analysis for each set might give an indication of whether the main source of variance was indeed in the production process. If this were so, one would expect the magnitude of the differences to decrease with greater experience in production of a particular design. This possibility is also suggested in a departmental report.

The manufacturing order of sets could only be ascertained for machine "A". It was Set II, Set I followed by Set III and the values for "F" obtained from a one-way analysis of variance for each set were:

44.39

28.80

and 10.21 respectively. While this still represents statistically significant differences for the latest set in order of manufacture, the magnitude of "F" appears to be in the expected direction. It is worth noting that the actual range of measured static frequencies for differences between wheels corresponding to an "F" of 10.21 represents only 5%. Such a range is considered quite satisfactory from a production point of view.

An inspection of Tables 5.1.1 and 5.1.2, will show that there appear to be differences in the distribution for the two types of machine. These will be discussed under Section 5.5.

5.2 Static wheel vibration measurements

In addition to static blade vibration tests each wheel is subjected to static tests treated as a disc. Eight modes are studied, but statistical analysis was carried out on the results for two to eight nodal diameters only, as zero and one nodal diameters are produced by the hub of the wheel. (See Chapter 2).

From these tests one would expect differences in vibration measurements for each mode. It is assumed however that there is no difference between wheels. It is ^{considered} particularly important that there should be consistency in performance at the fifth nodal diameter mode, because ^{this mode has in the past, been regarded as critical} ~~of its importance in the estimation of critical frequencies (see Figs 8 to 16 and 18 to 29).~~

As a first step the static wheel vibration frequencies for machine A and B (see Tables 4, 8 to 10 and 23 to 26 in the Appendix) were analysed by a two-way analysis of variance. Means and standard deviations for each of the 18 wheels are set out in Table 5.2.1 for machine "A" (firtree root).

Two-way Analysis of Variance Table
Static wheel mode vibration frequencies for machine "A"
 (See Tables 8 to 10 in the Appendix)

N = 7

g = 18

<u>Source of Variance</u>	<u>c.s.s.</u>	<u>d.f.</u>	<u>M.S.</u>	<u>F</u>
Between nodal diameters	8812.21	6	1468.70	2489.74
Between wheels	124.52	17	7.32	12.41
Residual	60.16	102	.58	
Total	8996.91	125		

Means and standard deviations for each of the 24 wheels are set out in Table 5.2.2 for machine "B" (riveted root).

Two-way Analysis of Variance Table
Static wheel mode vibration frequencies for machine "B"
 (See Tables 23 to 26 in the Appendix)

N = 7

g = 24

<u>Source of Variance</u>	<u>c.s.s.</u>	<u>d.f.</u>	<u>M.S.</u>	<u>F</u>
Between nodal diameters	5234.87	6	872.47	584.53
Between wheels	123.39	23	5.36	3.59
Residual	205.39	133	1.49	
Total	5564.24	167		

TABLE 5.2.1

MEANS AND STANDARD DEVIATIONS FOR NODAL DIAMETER MODE VIBRATION MEASUREMENTS
FOR EACH OF THE 18 WHEELS FOR MACHINE "A" (FIRTREE ROOT)

Wheel Number	SET I						SET II						SET III					
	1	2	3	4	5	6	7	8	9	10	11	12	13	14	15	16	17	18
Mean	96.5	98.3	99.8	97.9	97.9	99.8	96.4	98.1	96.7	99.5	97.4	97.8	97.9	98.0	96.3	97.8	97.6	98.2
Standard Deviation	8.4	8.3	8.9	8.7	8.7	8.9	8.5	9.0	8.5	9.1	9.1	8.6	9.1	8.8	9.4	10.0	9.9	9.8

TABLE 5.2.2
MEANS AND STANDARD DEVIATIONS FOR NODAL DIAMETER MODE VIBRATION MEASUREMENTS
FOR EACH OF THE 24 WHEELS FOR MACHINE "B" (RIVETED ROOT)

Wheel number	SET I						SET II						SET III						SET IV					
	1	2	3	4	5	6	7	8	9	10	11	12	13	14	15	16	17	18	19	20	21	22	23	24
Mean	96.8	96.9	97.6	97.7	97.4	96.7	97.3	95.4	96.2	96.9	95.5	96.5	97.7	96.4	98.7	97.1	96.3	94.0	95.0	94.5	96.6	95.9	95.0	93.7
Standard deviation	6.2	5.9	5.9	5.9	5.6	5.6	5.6	6.2	5.8	5.6	6.8	6.9	5.6	6.5	5.4	5.0	5.9	6.1	6.6	6.3	6.9	5.6	6.5	6.1

There is a statistically significant difference between wheels for both machine A and machine B. It was considered desirable to study the behaviour for each mode separately. This could only be attempted for machine "A" as the necessary measurements were not available for machine "B".

The results of one way analysis of variance of the static wheel mode vibration frequencies for different nodal diameters are as follows:

<u>Mode</u>	<u>F</u>
2 Nodal diameters	57.88
3 Nodal diameters	20.18
4 Nodal diameters	43.32
5 Nodal diameters	8.08
6 Nodal diameters	20.12
7 Nodal diameters	34.10
8 Nodal diameters	63.00

It can be seen that the difference between wheels appears to be smallest for the fifth mode, although it is statistically significant. However, the percentage difference ~~is~~ *ie. 7% (see p. 152)* in actual frequency measurements which give rise to a variation leading to an F of 8.08 are again quite satisfactory from an engineering point of view.

5.3 Stage five wheel vibration measurements

Because of the continuous coverband used to fix the ends of blades for stage five wheels (see Fig. 2), which involves lap-shroud, it is usually felt that vibration measurements for these wheels are somewhat less consistent than those for stage 6 wheels. The wheel mode behaviour in this case showed a complex form and several resonances at slightly different frequencies corresponding to any one particular nodal form were observed.

It was decided to carry out a two-way analysis of variance for data available for Stage 5 to investigate whether the observations derived from vibration testing would be borne out in the results. If this is the case, one would expect greater difference between wheels for this stage than for Stage 6.

Means and standard deviations for each of the 18 wheels are set out in Table 5.3.1 for machine "A".

Two-way Analysis of Variance Table

N = 7

Static wheel mode vibration frequencies for Stage 5 machine A 3 Sets g = 18

<u>Source of Variance</u>	<u>c.s.s.</u>	<u>d.f.</u>	<u>M.S.</u>	<u>F</u>
Between Nodal diameters	29153.65	6	4858.94	4879.43
Between wheels	382.89	17	22.52	22.61
Residual	101.57	102	.99	
Total	29638.12	125		

TABLE 5.3.1

MEANS AND STANDARD DEVIATIONS FOR NODAL DIAMETER VIBRATION MEASUREMENTS FOR EACH OF THE 18 WHEELS FOR STAGE 5 MACHINE "A"

Wheel Number	SET I									SET II									SET III								
	1	2	3	4	5	6	7	8	9	10	11	12	13	14	15	16	17	18									
Mean	237.0	241.7	239.9	239.3	240.2	239.4	243.1	242.5	241.7	241.2	241.5	243.2	241.4	240.0	239.4	236.6	240.2	240.2									
Standard deviation	16.7	16.0	16.0	16.0	16.8	16.0	17.2	17.1	16.0	16.1	16.7	17.0	15.8	15.9	15.7	16.3	17.0	16.8									

TABLE 5.3.2

MEANS AND STANDARD DEVIATIONS FOR NODAL DIAMETER VIBRATION MEASUREMENTS FOR EACH OF THE 18 WHEELS FOR STAGE 5 MACHINE "B"

Wheel Number	SET I						SET II						SET IV					
	1	2	3	4	5	6	7	8	9	10	11	12	13	14	15	16	17	18
Mean	215.4	216.3	220.5	214.3	218.5	213.9	214.0	213.4	218.2	212.8	213.5	216.1	209.8	210.8	216.0	210.1	213.2	213.0
Standard deviation	20.0	19.6	20.4	19.8	19.7	19.5	18.7	19.6	19.3	19.6	19.9	20.0	19.8	20.9	20.5	20.8	20.0	20.0

MEANS AND STANDARD DEVIATIONS FOR STAGE 5 MACHINE "B", 12 WHEELS SELECTED AT RANDOM

Wheel Number	SET II						SET III					
	1	2	3	4	5	6	7	8	9	10	11	12
Mean	211.3	207.1	212.8	211.4	213.9	212.8	213.5	215.1	218.5	215.3	215.2	211.9
Standard deviation	20.1	18.4	20.3	19.1	19.4	19.4	19.1	18.8	19.4	19.7	19.6	19.2

Two-way Analysis of Variance Table N = 7Stage 5 machine "A" for one set only g = 6

<u>Source of Variance</u>	<u>c.s.s.</u>	<u>d.f.</u>	<u>M.S.</u>	<u>F</u>
Between Nodal diameters	13550.89	7	1935.83	638.84
Between wheels	208.46	5	41.69	13.75
Residual	106.05	35	3.03	
Total	13865.40	47		

Means and standard deviations for each of the 18 wheels are set out in Table 5.3.2 for machine "B".

Two-way Analysis of Variance Table

N = 7

Static wheel mode vibration frequencies for Stage 5 machine B 3 Sets

g = 18

<u>Source of Variance</u>	<u>c.s.s.</u>	<u>d.f.</u>	<u>M.S.</u>	<u>F</u>
Between Nodal diameters	42915.31	6	7152.55	7294.80
Between wheels	980.66	17	57.68	58.83
Residual	100.80	102	.98	
Total	43996.78	125		

Two-way Analysis of Variance Table

N = 7

Stage 5 machine B 12 wheels selected at random

g = 12

<u>Source of Variance</u>	<u>c.s.s.</u>	<u>d.f.</u>	<u>M.S.</u>	<u>F</u>
Between Nodal diameters	27123.95	6	4520.65	4970.48
Between wheels	610.36	11	55.48	61.00
Residual	60.93	67	.90	
Total	27795.25	83		

If the F values for the four analyses of variance are examined together with those for the analysis of Stage 6 measurements and together with the means and standard deviations set out in Table 5.3.1 and 5.3.2, it appears that the assumptions set out at the beginning of this section may be true for machine B, but not necessarily for machine A.

5.4

As was stated at the beginning of this chapter, there are two main aims in bringing together vibration frequency measurements gathered over many years of testing: the

first is as an aid for comparative judgements to be made about any individual wheel that has to be tested. In any procedure which is based on empirical measurements only reference to a large number of similar measurements can give an estimate of the error involved in the judgement about a particular set of measurements. G.A. Luck, in several of his papers and reports, stresses this problem. The second, and perhaps even more important aim, is to ensure that the static measurements for any production wheel fall within a range found (from experimental wheel tests) to lead to correctly estimated values of critical speeds. Because of its importance the problems relating to this second aim are discussed more fully in Chapter 6.

In section 5.2 above, the question asked was whether there was a difference between wheels for the same type of machine. More appropriately the question should be divided into two parts:

- (i) Do the production wheels of a particular type of machine belong to the same population as the experimental wheel? (Which is used as a yardstick for production of dynamic behaviour).
- (ii) Is there a statistical test that can be applied to the measurements of any one production wheel to ascertain, with a known level of confidence, whether or not its static vibration measurements belong to the same population as those of the appropriate experimental wheel?

5.4.1 To attempt to answer question (i) above the average for all production wheels for each type of machine was compared with that for the respective experimental wheel.

H_0 : That

There is no difference between the grand mean static main blade vibration frequencies for 18 production wheels for machine "A" and the mean static main blade vibration frequencies for the experimental wheel for machine "A".

<u>Production wheels</u>	<u>Experimental wheel</u>
Grand Mean = 178.73	Mean = 175.34
Pooled Standard deviation = 2.52	Sd = 3.25
$s^2 = 26.61$	$s^2 = 10.48$

$$t = .66$$

$$df = 1805$$

F = 2.53 (although this indicates that the variances are not equal, the departure from the assumption of the t - test is not a major one and should not invalidate it)

$$t < t_{.05}$$

We can therefore accept the hypothesis that there is no statistically significant difference (at the .05 level) between the static blade vibration measurements of production wheels of the same type of machine.

H_0 : That

There is no difference between the grand mean static main blade vibration frequencies for 24 production wheels for machine "B" and the mean static main blade vibration frequencies for the experimental wheel for machine "B".

<u>Production wheels</u>	<u>Experimental wheel</u>
Grand Mean = 175.24	Mean = 173.90
Pooled Standard deviation = 1.11	Sd = 1.01
$s^2 = 1.22$	$s^2 = 1.02$

$$t = 1.21$$

$$df = 2225$$

F = 1.20 (not significant)

$$t < t_{.05}$$

We can therefore accept the hypothesis that there is no statistically significant difference (at the .05 level)

between the static main blade vibration measurements of production wheels for machine B and for the experimental wheel of the same type of machine.

If one now examines the histograms (see Figs. 32 to 40) representing the distributions of static blade vibration measurements for the two types of machine, the means of the distributions appear to be very close but that for machine A has a wider spread. A comparison of the experimental wheel for these two types of machine in fact gives an F ratio of 10 with d.f. = 95 for machine A and d.f. = 89 for machine B.

From the point of view of estimating values for critical speed both types of machine have a history of high reliability. If a choice between the two types of machine were to be made solely on the basis of the distribution characteristic of the static blade vibration measurements, one would probably opt for a machine of type B. There are other factors however which enter into such a decision including other technical and cost considerations. From a technical point of view one must reiterate that it is the behaviour under dynamic conditions that is of paramount importance. As will be seen from section 6.3 dynamic conditions through the action of centrifugal forces are expected to tighten root fixings and therefore reduce the spread of the distribution of vibration measurements.

The question of cost will be examined in Chapter 7.

5.4.2

The most obvious statistical test that can be applied to the static blade vibration measurements of a production wheel to see if these measurements differ significantly from those of the experimental wheel is a t - test. To apply this it is necessary to test for homogeneity of variances. This was done for 18 wheels of machine A and 24 wheels of machine B.



The results are as follows

Table of Test of Homogeneity of
Variances between Production Wheels
and Experimental Wheel for Machine A

<u>S² for Experimental</u>	<u>S² for Production</u>	<u>F</u>	<u>d.f.</u>
<u>Wheel</u>	<u>Wheel</u>		
10.58	7.71	1.37	n ₁ = 95
10.58	6.68	1.58	n ₂ = 95
10.58	93.89	8.87	
10.58	90.07	8.51	
10.58	4.17	2.53	
10.58	4.81	2.19	
10.58	16.77	1.58	
10.58	3.00	3.89	
10.58	3.65	2.89	
10.58	11.33	1.07	
10.58	41.00	3.87	
10.58	19.74	1.86	
10.58	8.17	1.29	
10.58	10.92	1.03	
10.58	2.54	4.15	
10.58	27.28	2.57	
10.58	66.59	6.29	
10.58	59.84	5.65	

Table of Test of Homogeneity of
Variances between Production Wheels
and Experimental Wheel for Machine B

<u>S² for Experimental</u>	<u>S² for Production</u>	<u>F</u>	<u>d.f.</u>
<u>Wheel</u>	<u>Wheel</u>		
1.02	0.80	1.27	n ₁ = 89
1.02	1.28	1.25	n ₂ = 89
1.02	.87	1.17	
1.02	1.06	1.04	
1.02	1.12	1.10	
1.02	.99	1.02	
1.02	1.40	1.37	
1.02	1.73	1.69	
1.02	2.66	2.61	
1.02	1.89	1.85	
1.02	3.14	3.67	
1.02	1.99	1.95	
1.02	.40	2.51	
1.02	1.23	1.21	
1.02	.52	1.93	
1.02	.30	3.36	
1.02	1.29	1.26	
1.02	1.03	1.01	
1.02	.69	1.47	
1.02	1.76	1.72	
1.02	1.26	1.24	
1.02	0.48	2.11	
1.02	0.79	1.29	
1.02	0.76	1.33	

From the results set out in the above tables what conclusions might one have drawn, had one applied this statistical test to each production wheel? In the case of machine B, in at least 16 out of 24 wheels one would have concluded (at the .02 level) that the vibration measurements come from a population with the same variance as that of the

experimental wheel, and one could proceed to a t - test to establish similarity of means.

For machine A the same conclusions and procedure would apply for 7 out of 18 wheels. This statistical test might therefore have "rejected" 19 wheels as not meeting the criteria of having static blade vibration measurements which have the same distribution parameters as the experimental wheel. Since the data analysed represent historical information it is known that in practice it has not been necessary to reject any of these wheels on technical grounds. The reason for this is that even for the case where the ratio between the two variances is 9 to 1 this represents a very small percentage difference when expressed in Hz. The means for this case are 174.60 Hz and 175.34 Hz for the production and experimental wheels respectively, and the standard deviations 9.69 Hz and 3.25 Hz. If one examines the figures in Table 5.1.1 it can be seen that the magnitude of the standard deviation for this wheel (set 1 wheel No. 3) is due to the value of the lower limit of the range of measurements being rather low when compared with other wheels.

As has already been stated these low frequency measurements rise under dynamic conditions. One might say that it is not necessary to reject wheels on technical grounds when the measurements do not show homogeneity of variance with those of the experimental wheel, providing the number of blades giving low readings is small.

Another way of interpreting the results might be to ask: if the vibration frequencies for a particular wheel have a mean of approximately 175 Hz and a standard deviation of 9 Hz (one of the largest standard deviations found), what is the probability of obtaining a frequency measurement of, say, less than 160 Hz or any value which might be considered "low"? From the area under the normal probability distribution it can be found that

$$z = \frac{160 - 175}{9} = -1.66 \text{ has an area of } .95. \quad \text{The}$$

probability of obtaining a measurement of 160 Hz or less is therefore .05. In other words, such measurement might be obtained for 5 out of 100 blades.

CHAPTER VI

THE USE OF EXPERIMENTAL WHEEL MEASUREMENTS

FOR PREDICTIVE PURPOSES

6.0 The usual practice in the Department is to use an experimental wheel as a yardstick against which to test production wheels of the same type. Static and dynamic measurements are taken. These are recorded in tabular and graphical form and discussed in reports. Judgement about the consistency or otherwise of measurements is based upon inspection of the graph and comparison of the range or spread of measurements. The interpretation of graphical results and of the range or percentage spread of a large number of measurements does not appear to reflect the accuracy demanded of the measures themselves.

(c.f. chapter 4, Description of Measurements).

It was therefore decided to attempt a statistical analysis of the data to see whether the more concise and precise statement of comparisons arrived in this way was in line with engineering "experience" built up over the last forty years.

The analysis took 3 main forms:

- (i) Tests of the measurements on the "experimental" wheel to see if its use as a yardstick is justified.
- (ii) Analysis of measurements on "production" wheels where engineering judgement had been made to see if statistical tests produce results in line with such judgements.
- (iii) Verification of the "rule" used to estimate the fundamental tangential frequency at running speed.

As mentioned in Chapter 3, two types of machine type 'A' and type 'B' have been used throughout.

6.1 For (i) above the following hypotheses were tested:

H_{01} : That

There is no difference between the measurements of static blade fundamental tangential frequencies of Experimental machine 'A' taken when 'new', just before running, and after being subjected to dynamic test.

	<u>New</u>	<u>After Dynamic Test</u>	$N = 96$
Mean	175.34	175.34	$\bar{d} = 0.06$
s.d	3.25	5.48	$s.\bar{d} = 6.20$
			$t = 0.10$

$$t < t_{.05}$$

$$\text{For d.f. } 95, t_{.05} = 1.99$$

Since $t < t_{.05}$ on a two-tailed test we can accept the hypothesis (H_{01}) that there is no statistically significant difference at the .05 level between fundamental tangential blade frequencies measured before and after dynamic test. (See tables 1 and 2 in the Appendix and Fig. 32).

H_{02} : That

There is no difference between the measurements of static fundamental tangential blade frequencies taken just after dynamic test and two weeks later.

	<u>After dynamic Test</u>	<u>Two weeks later</u>	<u>N = 96</u>
Mean	175.34	174.60	$\bar{d} = 0.74$
s.d	5.48	6.13	$s.\bar{d} = 4.76$
			$t = 1.52$
			For d.f. = 95, $t_{.05} = 1.99$

$$t < t_{.05}$$

Since $t < t_{.05}$ on a two-tailed test we can accept the null hypothesis (H_{02}) that there is no statistically significant difference at the .05 level between static fundamental tangential blade frequencies measured just after dynamic test and two weeks later (after the machine had been standing idle in the laboratory). (See Tables 2 and 3 in the Appendix, Fig. 32).

When the comparisons were made only on the data set out in tables 1, 2 and 3, it was found that the range of frequencies had increased from 11.8% while new to 20.30% just after dynamic test. Two weeks later the range was found to be 17.8%. Experienced engineers were able to explain such variations in terms of expected temperature changes and changes in the stresses set up between different groups of blades because of the stationary position of the huge wheel. However, the statistical analysis reported above allows one to state, with a known level of confidence, that the "experimental" wheel can still be used as a yardstick even after being subjected to both a dynamic test and a period of storage.

6.2 It will be recalled that some of the data for the statistical analysis carried out in this and the succeeding chapter was based on measurements obtained over a period of more than five years. It was therefore important to make use of an opportunity of analysing the results of measurements on production wheels of machine type "A", which has not yet commenced operation.

Two production wheels which had been tested statically six months earlier were still in storage, awaiting installation. It was therefore decided to measure the fundamental tangential blade frequencies again and it was hypothesised that

H_{03} : That

There is no difference between the measurements of static blade fundamental tangential frequencies of production wheels 1 and 2 for machine A* (Last-stage) (See Table 14 and 15 in the Appendix) when new and taken after a period of storage lasting six months.

WHEEL 1

	<u>New</u>	<u>Six Months later</u>	N = 96
Mean	176.8	176.83	$\bar{d} = 0.72$
s.d	7.9	5.77	$s.\bar{d} = 5.21$
			$t = 1.35$

$$t < t_{.05} \quad \text{For d.f.} = 95, t_{.05} = 1.99$$

Since $t < t_{.05}$ on a two-tailed test we can accept the hypothesis (H_{03}) that there is no statistically significant difference, at the .05 level, between fundamental tangential blade frequencies measured for Wheel 1 new, just after manufacture, and six months after manufacture, before installation. (See Tables 14 and 15)

WHEEL 2

	<u>New</u>	<u>Six months later</u>	N = 96
Mean	165.6	176.55	$\bar{d} = 4.93$
s.d.	9.6	13.13	s.d. = 9.57
			t = 4.72

$$t > t_{.05}$$

$$\text{For d.f} = 95, t_{.05} = 1.99$$

Since $t > t_{.05}$ on a two-tailed test we reject the hypothesis (H_{03}) that there is no statistically significant difference at the .05 level between fundamental tangential blade frequencies measured new just after manufacture and six months later for Wheel 2 (See Tables 16 and 17 in the Appendix).

While the hypothesis can be accepted for Wheel 1, it must be rejected for Wheel 2, since $t > t_{.05}$.

After these findings were known, engineers from production personnel suggest that the difference found for wheel 2 is not merely a statistical one, but may be due to the fact that inappropriate spacers had been fitted, which may have resulted in a settling of the root fixation during the storage period, which would account for the increase on average of the fundamental tangential blade frequencies measured on the second occasion. (See Tables 14, 15, 16, 17 in the Appendix).

After running in service for some nine years, it was necessary to check a machine type "B" riveted root of 120 MW for erosion and necessary blade check. The opportunity was taken to measure the fundamental tangential blade static frequencies of one of the last stages before it was repaired to show how they had been changed by service running and by the erosion damage which had occurred. Frequency Measurements were made in the usual way on each blade of the wheel by impact and the results are compared with those of the blades in new condition (See Tables 27, 28 in the Appendix).

The following hypothesis was tested:

H_{04} : That

There is no difference between the measurements of fundamental tangential blade frequencies taken when new and after nine years service.

	<u>New</u>	<u>After 9 years</u>	
Mean	204.90	202.55	$N = 109$
			$\bar{d} = 2.33$
s.d.	1.81	.74	s.d. = 1.79
			$t = 13.67$

For d.f. = 108, $t_{.05} = 1.98$

Since $t > t_{.05}$ on a two-tailed test we reject the hypothesis (H_{04}) that there is no statistically significant difference at the .05 level between fundamental tangential blade frequencies taken when new and after nine years.

An examination of the blades before second measurements were taken showed substantial corrosion. (See Fig. 41 in the Appendix). This might lead to a prediction of a decrease in fundamental tangential blade frequency measurements. This was indeed the case. (See Tables 27 and 28 in the Appendix). However, the small magnitude of the changes can be interpreted as meaning that the wheel had stood up very well to service conditions. The effect of service running is clearly to reduce the range of frequencies; the measured change is from 2.9% to 1.90%. Service running is expected to cause filling of root clearances by oxide and other deposits and to raise frequencies, while the wearing away of part of blades by erosion damage is expected to drop blade frequency.

Statistical analysis shows that it is a "different" wheel and therefore some of the operating constraints may no longer hold.

6.3 Dynamic measurements

From Chapter 4 (Measurements of vibration frequencies) it can be seen that the main object of vibration tests carried out on blades and wheels is to predict their performance under running conditions. More specifically, this means being able to say that at running speed the excitation frequencies do not occur within a range of critical frequencies.

While each production wheel is subjected to a static test, (See Chapter 5) dynamic tests are not usually carried out on production wheels. It is therefore necessary to study the behaviour of experimental wheels under dynamic conditions and to use the findings to predict the behaviour of production wheels under similar conditions. The basic method for this procedure was first proposed by Campbell (1924) and has been developed in the Department over many years.

When a turbine wheel rotates, blade fixations change and there is a general stiffening effect on the whole assembly. It may be shown theoretically that, considering the blade stiffness alone, the relation between frequency F_R (c/s) at speed R (rev/sec) and static frequency F_o (c/s) is given by the relation

$$F_R^2 = F_o^2 + K_s R^2 \text{ where } K_s \text{ is rotational parameter.}$$

A plot of frequency squared against rotational speed squared for machine "A" (firtree root) experimental wheel for blades 19, 20, 27, 62, 64, 76 (See Figs. 24 to 29) gives a range of K_s values, where (See Table 6.3.3.)

$$K_s = \frac{F_R^2 - F_o^2}{2500} \quad \text{At running speed}$$

K_s thus represents the slope of a straight line on $F^2 - R^2$ graphs joining the static frequency to the frequency at 50 rev/sec: (i.e. running speed of the machine).

To derive values of the rotational coefficient (K_s) from the experimental wheel results, the appropriate static blade vibration frequency must be selected.

To ensure successful use of the procedure it is necessary not only to verify the consistency of static measurements

but to verify that this consistency is maintained for various speeds, and in particular at running speed.

Over the years tests for this purpose have been carried out on selected blades of experimental wheels type "A" and type "B". The blades were selected to represent extreme and average values of frequency under static conditions.

TABLE 6.3.1

FREQUENCY SPREAD OF SELECTED BLADES AT VARIOUS SPEEDS FOR
FUNDAMENTAL TANGENTIAL BLADE MODE FOR EXPERIMENTAL WHEEL "A"
(FIRTREE ROOT)

Speed rpm	Frequency in Hz						
	Blade Numbers						
	19	20	27	62	64	76	Spread %
0	168.2	171.8	181.0	178.6	172.4	175.5	7.6
500	171.0	174.0	182.1	180.0	175.4	177.8	6.5
1000	179.0	181.0	187.0	185.5	182.0	184.2	5.5
1500	189.0	189.8	194.0	193.2	190.0	192.9	2.6
2000	199.3	198.8	201.7	202.0	199.3	201.9	1.6
2500	210.1	210.0	210.5	212.2	208.2	212.0	1.8
2750	215.0	215.9	216.0	218.2	213.2	217.0	2.3
3000	220.1	222.0	221.8	222.2	217.5	222.1	1.9

TABLE 6.3.2

FREQUENCY SPREAD OF SELECTED BLADES AT VARIOUS SPEEDS FOR
FUNDAMENTAL TANGENTIAL BLADE MODE FOR EXPERIMENTAL WHEEL "B"
(RIVETED ROOT) (UNSUPPORTED BLADES)

Speed rpm	Frequency in Hz										Spread %
	Blade Number										
	8	10	28	30	34	35	57	60	84	85	
0	44.4	41.8	45.8	43.5	43.6	44.7	40.0	40.6	44.6	41.2	13.5
500	46.3	45.8	47.4	46.9	46.9	47.4	43.6	44.7	46.7	44.7	8.4
1000	52.0	51.0	51.9	52.0	52.0	52.4	50.0	50.5	51.9	50.4	4.7
1500	59.5	58.3	59.1	59.1	59.1	60.0	60.0	59.1	60.4	58.3	2.9
2000	68.5	66.4	67.1	68.5	67.1	68.5	68.5	67.8	67.0	66.3	3.3
2500	77.7	76.9	76.5	76.9	77.4	78.7	76.7	77.4	75.8	76.0	1.4
2750	82.4	81.9	81.5	81.2	81.2	82.4	81.1	81.8	80.3	80.6	1.5
3000	86.4	87.1	86.7	85.6	85.8	87.1	85.0	86.4	85.1	84.1	3.5

A two-way analysis of variance was carried out on the available readings for both wheels to test the hypothesis:

$H_{0.5}$ That

There is no difference in fundamental tangential frequencies between blades at various speeds.

Analysis of Variance for Table 6.3.1.

<u>Source of Variance</u>	<u>CSS</u>	<u>d.f</u>	<u>MS</u>	<u>F</u>
Between speeds	13550.87	7	1935.83	638.84
Between blades	208.46	5	41.69	13.75
Residual	106.05	35	3.03	
Total	13865.39	47		

$F > F_{.05}$

Analysis of Variance for Table 6.3.2

<u>Source of Variance</u>	<u>CSS</u>	<u>d.f.</u>	<u>MS</u>	<u>F</u>
Between speeds	19130.34	7	2732.90	3490.74
Between blades	39.77	9	4.41	5.64
Residual	49.32	63	.78	
Total	19219.44	79		

$$F > F_{.05}$$

Given that $F > F_{.05}$ in both cases we have to reject (H_0), and to state that there is a statistically significant difference between blades under the conditions tested.

Experience has shown however that measurements for machine type B, which has been in operation for nine years, were adequate for reliable predictions of performance. It is therefore worthwhile to comment on the results of the statistical analysis.

The difference between blades could arise from two main sources - root fixation and geometry of the blade, i.e. manufacturing tolerances. The dynamic test on the wheels showed that the ranges reduced (see Table 6.3.1 and Table 6.3.2) considerably with speed until, at service speed, the spread for blades with extreme static frequencies was about 1.9%. The interpretation of this blade behaviour is that the static ranges are extended downwards by an initial root fixation, i.e. "looseness" in the fixing of many blades and that this "looseness" is removed by the action of centrifugal forces, bringing all the blades to a more uniform root condition. The variation in behaviour between blades is then determined mainly, or perhaps wholly, by differences in manufacturing tolerances. The blade frequency for any particular blade varied from time to time (on the assumption that frequency lowering resulted from increased root looseness) perhaps because of slight ambient temperature changes.

For the blades of the test wheel on which measurements were made this effect gave a range of coefficient values.

6.3.1. Estimating vibration frequencies at running speed for production wheels

The most important phase of the method of using dynamic measurements on experimental wheels for the purpose of predicting critical speeds of production rotors is the selection of the most appropriate K_S value.

To derive K_S values for any one blade, several static frequencies are available (See Table 6.3.3).

TABLE 6.3.3.

DYNAMIC BLADE VIBRATION TEST RESULTS FOR FUNDAMENTAL TANGENTIAL MODE FOR EXPERIMENTAL WHEEL TYPE 'A' (FIR TREE ROOT)

Blade Number	Range of impact Excitation	Frequency in Hz		Range of K_S Values
		Static	At 3000 RPM	
		Crystal Excitation	Crystal Excitation	
19	158.1 to 178.2	168.2	220.1	6.7 to 9.4
20	150.6 to 186.2	171.8	222.0	5.7 to 10.7
27	174.6 to 185.2	181.0	221.8	6.0 to 7.5
62	175.8 to 180.4	178.6	224.2	6.9 to 7.7
64	165.5 to 168.9	172.4	218.2	7.6 to 8.1
76	171.7 to 175.5	175.5	222.1	7.4 to 7.9

The problem then consists in selecting the most appropriate combination of K_s value and static blade frequency to estimate the dynamic frequency at running speed.

Possible combinations are:

- (a) Highest static frequency and Lowest K_s value
- (b) Highest static frequency and Highest K_s value
- (c) Lowest static frequency and Highest K_s value
- (d) Lowest static frequency and Lowest K_s value

The most appropriate combination could be defined as that which produced estimates of frequencies at running speed which did not differ significantly from actual measurements at the same speed. The practice followed in the Department based on observation of the range of critical speeds estimated from various combinations suggests that the most appropriate combination results from selecting either highest static frequency and lowest K_s value or lowest static frequency and highest K_s value. One might therefore hypothesise that:

F₀₀ That:

For either of the above combinations there will be no difference between estimated and measured frequencies at running speed and

F₀₁ That:

For combination of lowest static frequency and lowest K_s value, or highest static frequency, highest K_s value, there is a difference between estimated and measured frequencies at running speed.

To test H_{06} the following data were used.

TABLE 6.3.4

FREQUENCIES AT 3000 R.P.M. IN Hz.

Blade Number	Measured (x_1)	Estimated (based on highest frequency and lowest K_s) (x_2)
19	220.1	220.23
20	222.0	221.17
27	221.8	222.03
62	224.2	223.14
64	218.2	218.00
76	222.1	222.03

$$\begin{aligned} \text{Mean } \bar{x}_1 &= 220.95 & \bar{x}_2 &= 221.10 & F &= 1.06 \\ \text{s.d.}_1 &= 1.86 & \text{s.d.}_2 &= 1.80 & & \text{(Not significant)} \\ & & & & t &= .14 \\ & & & & \text{d.f.} &= 10 \end{aligned}$$

$$t < t_{.05}$$

TABLE 6.3.5

FREQUENCIES AT 3000 R.P.M. IN Hz.

Blade Number	Measured (x_1)	Estimated (Based on lowest frequency and highest K_s) (x_2)
19	220.1	220.21
20	222.0	222.32
27	221.8	221.89
62	224.2	223.95
64	218.2	218.26
76	222.1	221.88

$$\begin{aligned} \bar{x}_1 &= 220.95 & \bar{x}_2 &= 221.42 & F &= 1.09 \\ \text{s.d.}_1 &= 1.86 & \text{s.d.}_2 &= 1.95 & & \text{(Not significant)} \\ & & & & t &= .42 \\ & & & & \text{d.f.} &= 10 \end{aligned}$$

$$t < t_{.05}$$

We can therefore accept the hypothesis (H_{05}) that a combination of highest frequency and lowest K_s values or lowest frequency and highest K_s value will result in accurate estimates of dynamic frequencies at running speed.

To test H_{07} the following data were used:

TABLE 6.3.6

FREQUENCIES AT 3000 R.P.M. IN Hz

Blade Number	Measured (x_1)	Estimated (Based on highest frequency, and highest K_s) (x_2)
19	220.1	235.06
20	222.0	247.83
27	221.8	230.32
62	224.2	227.58
64	218.2	220.85
76	222.1	224.83

$$\begin{aligned} \bar{x}_1 &= 220.95 & x_2 &= 231.08 & F &= 26.12 \\ \text{s.d.}_1 &= 1.86 & \text{s.d.}_2 &= 9.51 & & \text{(Significant)} \\ & & & & t &= 2.55 \end{aligned}$$

$$F > F_{.05}$$

$$t > t_{.05}$$

TABLE 6.3.7

FREQUENCIES AT 3000 R.P.M.

Blade Number	Measured (x_1)	Estimated (Based on lowest frequency and lowest K_s value) (x_2)
19	220.1	204.31
20	222.0	192.12
23	221.8	213.27
62	224.2	219.44
64	218.2	215.38
76	222.1	219.04

$$\begin{aligned} \bar{x}_1 &= 220.95 & \bar{x}_2 &= 210.57 & F &= 32.7 \\ \text{s.d.}_1 &= 1.86 & \text{s.d.}_2 &= 10.63 & & \text{(Significant)} \\ & & & & t &= 2.35 \\ & & & & \text{d.f.} &= 10 \end{aligned}$$

$$F > F_{.05}$$

$$t > t_{.05}$$

Since $F > F_{.05}$ the two samples of measurements come from different populations and the assumptions underlying the t-test is not met.

The analysis so far has been confined to the experimental wheel itself. If the combinations set out above are indeed appropriate, one would hypothesise that

H_{08} That:

There is no difference between measured frequencies for an experimental wheel and estimated frequencies for production wheels of the same type, where the estimated frequencies are obtained by the procedure set out below:

For any blade on the production wheel, note the static frequency and find the range of impact excitation frequencies measured on the experimental wheel of which the static frequencies of the selected blade represents a value close to the upper limit of the range.

From this range, take the lower K_s value. Or vice-versa, if the selected static blade frequency is matched to the lower limit of a range of measured frequencies.

The above hypothesis was tested by using six blades of L.P. Steam Turbine machine "A" (Firtree root), Set 1 and Set 2, (See Tables 5 and 6 in the Appendix) and 8 blades of machine "B" (riveted root, unsupported blades).

To Test H_{08} the data and results are as follows:

TABLE 6.3.8

FREQUENCIES AT 3000 R.P.M. IN Hz
LP STEAM TURBINE MACHINE "A" (FIRTREE ROOT) SET I.

Blade Number	Measured (x_1)	Estimated (Highest frequency and lowest K_s) (x_2)
19	220.1	224.84
20	222.0	224.52
27	221.8	222.11
62	224.2	222.25
64	218.2	222.33
76	222.1	219.18

$$\bar{x}_1 = 220.95 \quad \bar{x}_2 = 222.54$$

$$s.d._1 = 1.86 \quad s.d._2 = 2.03$$

$$F = 1.19$$

(Not significant)

$$t = 1.41$$

$$d.f. = 10$$

$$t < t_{.05}$$

TABLE 6.3.9

FREQUENCIES AT 3000 R.P.M. IN Hz

LP STEAM TURBINE MACHINE "A" (FIRTREE ROOT) SET 2.

Blade Number	Measured (x_1)	Estimated (Based on lowest frequency and highest K_s value) (x_2)
19	220.1	217.63
20	222.0	223.55
27	221.8	223.06
62	224.2	220.61
64	218.2	220.61
76	222.1	223.63

$$\bar{x}_1 = 220.95 \quad \bar{x}_2 = 221.52$$

$$s.d._1 = 1.86 \quad s.d._2 = 2.35$$

$$F = 1.59$$

(Not significant)

$$t = 2.18$$

$$d.f. = 10$$

$$t < t_{.05}$$

TABLE 6.3.10

FREQUENCIES AT 3000 R.P.M. IN Hz
LP STEAM TURBINE MACHINE "B" (RIVETED ROOT).

Blade Number	Measured (x_1)	Estimated (Based on lowest frequency and highest K_s value) (x_2)
8	159.6	159.70
10	158.1	159.35
28	158.6	158.61
30	160.9	159.64
34	160.9	158.43
35	160.9	160.79
57	160.5	154.26
60	161.0	158.09
84	160.4	160.31
85	158.0	157.92

$$\bar{x}_1 = 159.89 \quad \bar{x}_2 = 158.41$$

$$s.d._1 = 1.22 \quad s.d._2 = 1.95$$

$$F = 1.19$$

(Not significant)

$$t = 1.41$$

$$d.f = 18$$

$$t < t_{.05}$$

TABLE 6.3.11

FREQUENCIES AT 3000 R.P.M. IN Hz

LP STEAM TURBINE MACHINE "B" (RIVETED ROOT, UNSUPPORTED BLADES)

Blade Number	Measured (x_1)	Estimated (Based on highest frequency and lowest K_s value) (x_2)
8	86.8	87.87
10	87.1	86.58
28	86.7	88.58
30	85.6	85.97
34	85.8	86.02
35	87.1	86.95
57	85.0	85.73
60	86.4	86.01
84	85.1	86.53
85	84.1	84.83

$$\bar{x}_1 = 85.97$$

$$\bar{x}_2 = 86.47$$

$$F = 1.10$$

$$s.d._1 = 1.01$$

$$s.d._2 = 1.07$$

(Not significant)

$$t = 1.04$$

$$d.f. = 18$$

$$t < t$$

.05

The results show that in all four cases it is possible to accept H_{07} for machine 'A', H_{08} for machine 'B', and this finding gives added confidence to the usefulness of the usual practice of estimating frequencies at running speed.

CHAPTER VIIDISCUSSION AND CONCLUSIONS

The aim of the present investigation was to study the possibility of applying statistical techniques to vibration frequency measurements of bladed turbine wheels. It was hoped that the application of these techniques would permit a more concise, and possibly a more precise, description of the distribution characteristics of such measurements. As far as the writer was able to ascertain, no study of the application of statistical techniques to turbine bladed wheel vibration measurements has been published. This may be due to the fact that "Topics related to interpretation, such as hypothesis testing, risk and inference, are somewhat foreign to traditional engineering subject matter." (Bartee, E.M., Statistical methods in Engineering experiments, Columbus, Ohio, Charles, E. Merrill Books, Inc. Page V). The more traditional approach is the construction of mathematical models for predictive purposes. Many attempts to construct mathematical models of the behaviour of blades and wheels under vibration have not been found very satisfactory in relation to production problems.

Given the dimensions of the turbine wheels and the cost associated with both production and testing, it was not feasible to carry out specific experiments to test assumed relationships. It was therefore decided to select from the vibration measurement data available as a result of many years testing, such information that would allow at least reasonably controlled comparisons. To satisfy this need and also the desirability of studying measurements with important practical implications, the bladed wheels of last stage LP turbines, differing mainly in root fixation were selected.

It can be seen from Chapter 5 that an attempt was made to compare the distribution parameters for the two types of wheels. The design and manufacturing process of the riveted and fir-tree type of root fixation have been the subject of considerable discussion. While the capital investment for the manufacture of fir-tree root fixings is considerable, the man/hours involved are fewer

than for riveted roots. For example, for fixing approximately 2000 blades, the labour and overhead costs for riveted roots are almost twice as high as those for fir-tree roots. This does not take into account the cost of replacing individual blades. This suggests that, in the long-term, there might be cost advantages in using fir-tree root fixings for large turbine wheels, particularly if they are found to be as reliable as the riveted type. It was not intended in this study to test this reliability, but merely to try out statistical techniques which might eventually be of use for such a purpose.

The four steps of the analysis and the findings were:-

- (i) A study of static blade vibration measurements for production wheels (Sets 1, 2, 3) of machine 'A' (fir-tree root) and production wheels (Sets 1, 2, 3, 4) of machine 'B' (riveted root).

A one-way analysis of variance was used to test the assumption that there is no difference between wheels for the same type of machine. In fact statistically significant differences at the .05 level were found, which do not correspond to differences of engineering significance. Although the data satisfy the assumptions underlying the analysis of variance, this test may be too powerful in relation to the kind of tolerances that can safely be allowed on technological grounds. An examination of the results for both types of machine (see Table 5.1.1 and 5.1.2) shows that the high values of 'F' arise from the very low value for the residual (within wheel) variance. This is particularly so for machine 'B' and is in line with the expectation for riveted root fixation. One would also expect that the between wheel variation would decrease with greater manufacturing experience. When sets were tested in the order of manufacture the 'F' value did in fact decrease in the expected direction.

- (ii) A study of static wheel mode vibration measurements for the same sets of the above machines.

In this case the two-way analysis of variance was the appropriate technique, given an expected variation according to modes and no

'difference' expected between wheels. However (see Tables 5.2.1 and 5.2.2) the differences between wheels were found to be statistically significant at the .05 level. The residual variance is again very small, tending to inflate the value of 'F'. The information from static wheel vibration measurements is used to find which are likely to be the critical modes at running speed. ^{Although} The graphs Figs. 8 to 16 ^{do not} ~~show~~ ~~no~~ ~~great consistency in pointing~~ to the fifth nodal diameter as the critical one, ^{production practice is to consider it as such.} It appears therefore that the static wheel vibration measurements obtained are quite satisfactory on technological grounds. Given that the fifth ^{is taken} ~~appears~~ to be the critical mode, one would expect that differences between wheels would be least pronounced at this mode. When data for each nodal diameter were subjected to one-way analysis of variance the F value for the analysis at the fifth mode was found to be the lowest.

(iii) Stage Five.

The study of static wheel mode vibration measurements for stage 5 for the above machines (for comparative purposes).

The main reason for analysing stage 5 measurements was to find out whether greater variability predicted on technical grounds would be reflected in the results of statistical analysis. This was found to be the case on the whole, although the results are not entirely clear-cut.

(iv) Distribution characteristics:

The lack of reliable mathematical models makes extensive empirical measurements of vibration frequencies necessary. To keep these to a minimum "experimental" wheels are used as "yardsticks". It is necessary therefore that production wheels of a particular type should resemble experimental wheels closely.

For the purpose of this investigation it was possible to use pooled information of blade vibration measurements on production wheels obtained over a period of some ten years. It was found that there was no statistically significant difference at the .05 level between the "average" production wheel and the experimental wheel of the same type.

If however any individual production wheel is compared with the respective experimental wheel, statistical significant differences at the .05 level are sometimes found. When the vibration frequency measurements for such wheels are examined it is found that the range of the difference in Hz is on average only 5%. This is quite an acceptable variation from an engineering point of view.

The effect of root fixation was found to be in line with design expectations namely:
That the average blade vibration frequency measurements for the two types of wheels should be very similar, but that the looseness of blades with fir-tree roots would be reflected in greater spread. The histograms (Figs. 32 to 40) and the means and standard deviations (Tables 5.1.1 and 5.1.2) show this to be so. Histograms were used for description and comment of the vibration measurement distribution. It is argued here that by using the parameters of the distribution one can predict the likelihood of obtaining measurements which may be less reliable. A specimen test of such a contingency showed that even where there is a 9 to 1 ratio between the standard deviations of a production wheel and the experimental wheel of the same type, the probability of finding a blade measurement outside the desirable range was only 5 out of 100.

The need for empirical measurements for predicting performance under dynamic conditions leads to the use of Campbell's method for estimating critical frequencies at running speed by taking an appropriate value of the static frequency measurement combined with a rotational coefficient (K_s). To make appropriate estimates two factors are essential: a reliable measurement of the static vibration frequency and a selection of the "best" combination between static frequency reading and K_s value.

In Chapter 6 the steps taken to analyse this process are described under three headings:

- (i) Tests of the measurements on the 'experimental' wheel to see if its use as a yard-stick is justified.

A comparison of static blade fundamental tangential frequency measurements on the experimental wheel at three points in time: when new, after undergoing dynamic test and two weeks later showed that there were no statistically significant differences at the .05 level between the measurements; it can therefore be stated that the 'experimental' wheel exhibits the consistency one might expect.

- (ii) Analysis of measurements on 'production' wheels where engineering judgement had been made to see if statistical tests produce results in line with such judgements.

Conversely, it was decided to test whether variations expected on technical grounds would be reflected in the results of statistical analysis. Three production wheels provided data for this purpose. Two were tested after six months storage prior to operation. For one there was a statistically significant difference at the .05 level. It was found that this did correspond to expectation from the effect of wrongly placed spacers. There was no statistically significant difference between the vibration measurement for the second, which was also considered satisfactory on technological grounds. The third wheel was tested after a period in operation of some nine years. It was still performing adequately, but was due to be serviced. A comparison of frequency measurements when new and nine years later showed a statistically significant difference beyond the .05 level. This was found despite the fact that during such a long period of operation two factors - deposit of oxides near the roots and corrosion in the blades - might be expected to counteract each other in terms of effect on blade vibration measurements. Inspection of blades (see Fig. 42 in the appendix) confirmed extensive corrosion, which is in line with the statistical 'difference' found.

- (iii) Verification of the 'rule' used to estimate the fundamental tangential frequency at running speed.

When the dynamic vibration measurements for selected blades are analysed by a two-way analysis of variance a statistically significant difference at the .05 level is found between blades. Once again the value of 'F' appears to be inflated by the very small

GENERAL CONCLUSIONS

The overall results suggest that the application of statistical techniques to the analysis of vibration measurements could make a valuable contribution to a very complex and expensive procedure. Further study is required to decide whether the techniques used are indeed the most appropriate to show up variations which are of engineering significance. The .05 level of statistical significance was set arbitrarily, because it is the most frequently used level for problems of this kind. The setting of ' α ' in relation to production or operating decisions would require more detailed analysis. However, in the two areas of greatest practical importance: the comparison of production and experimental wheels in static tests and the estimates of dynamic measurements, the results of the statistical analysis give added confidence to current practice and suggest a more precise definition of procedure.

FREQUENCY HISTOGRAMS OF STATIC MAIN BLADE FREQUENCIES IN Hz FOR EXPERIMENTAL WHEEL OF MACHINE "A" (PISTON ROOT)

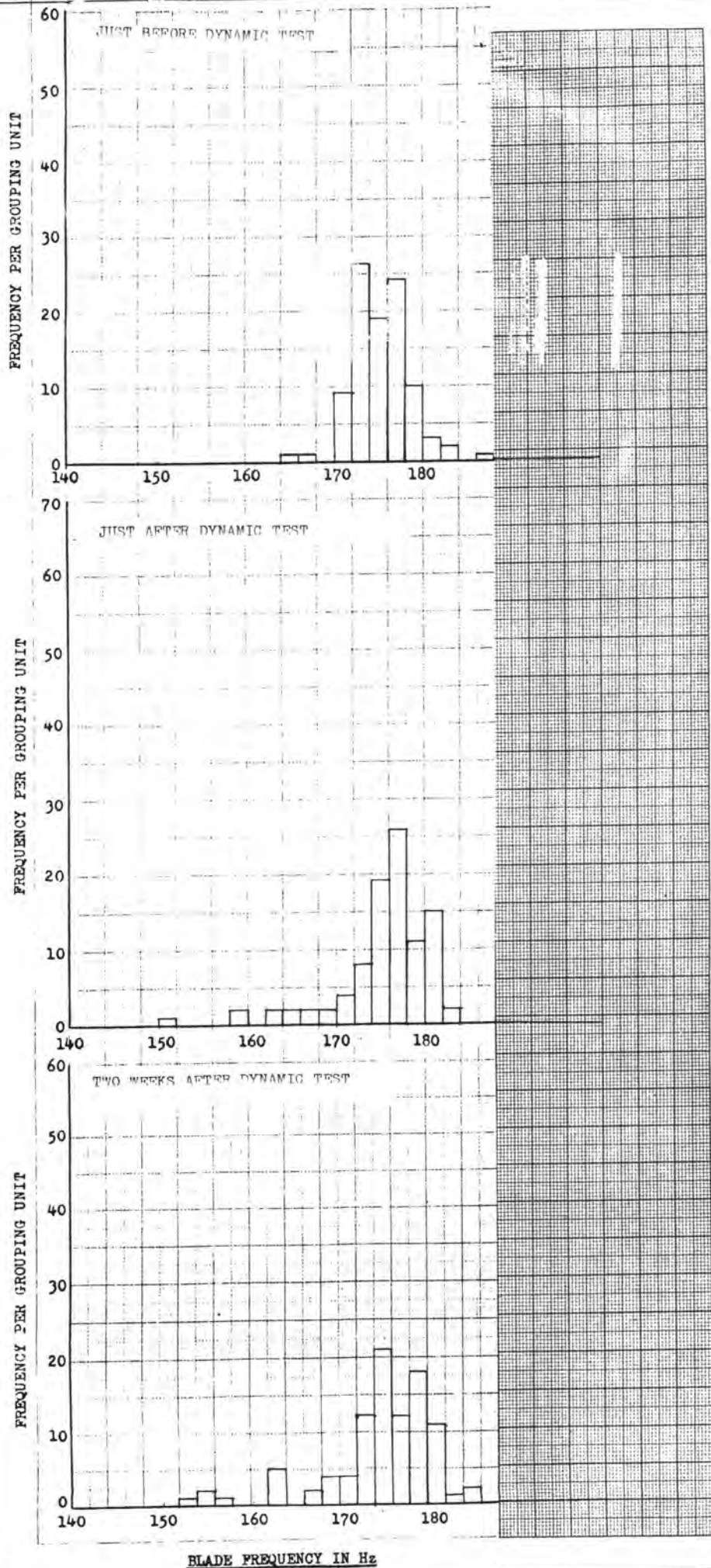
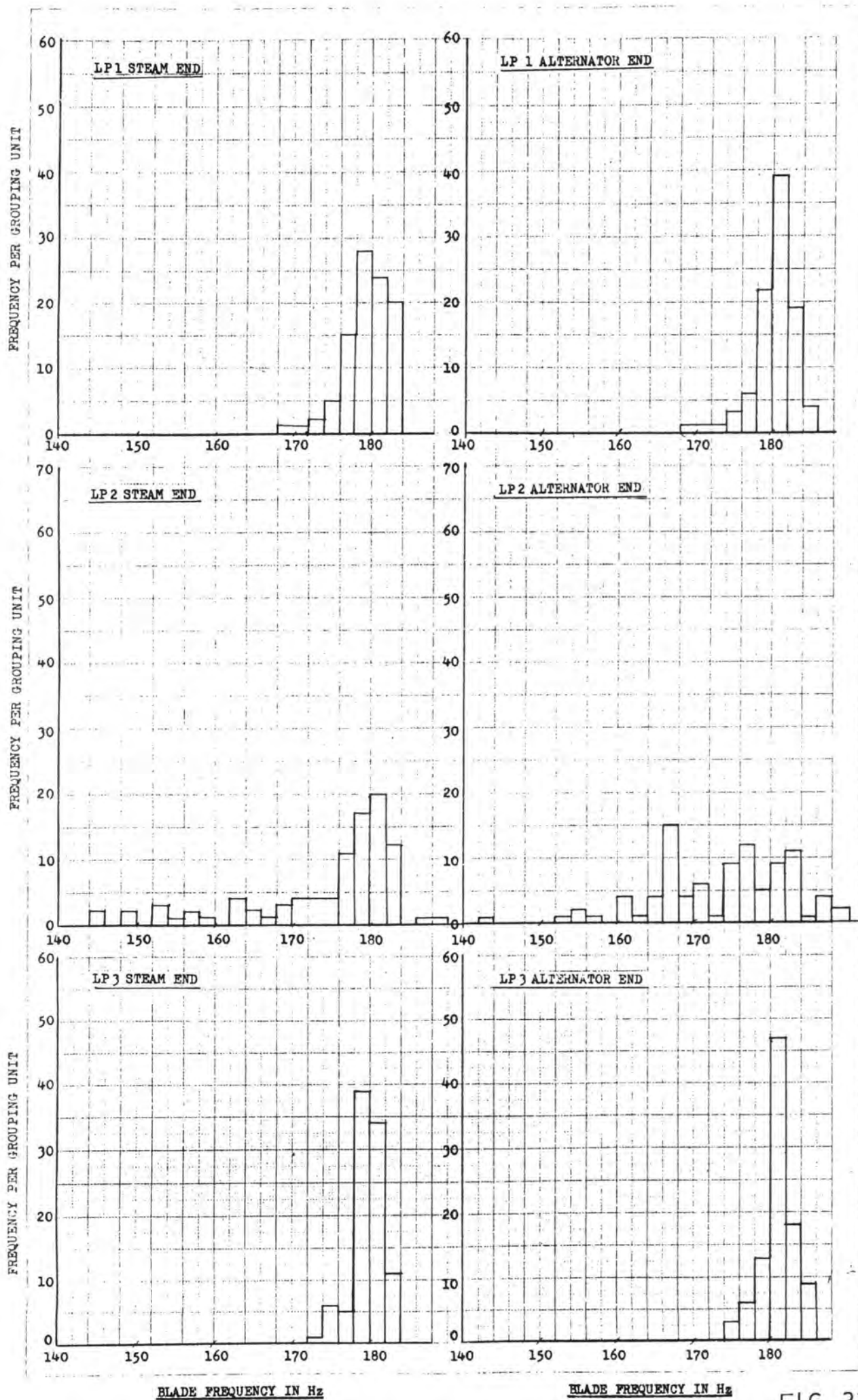

FIG. 32.

FREQUENCY HISTOGRAMS OF STATIC MAIN BLADE FREQUENCIES IN Hz OF MACHINE "A" SET I.



BLADE FREQUENCY IN Hz

BLADE FREQUENCY IN Hz

FIG. 33.

FREQUENCY HISTOGRAMS OF STATIC MAIN BLADE FREQUENCIES IN Hz OF MACHINE "A" SET 2.

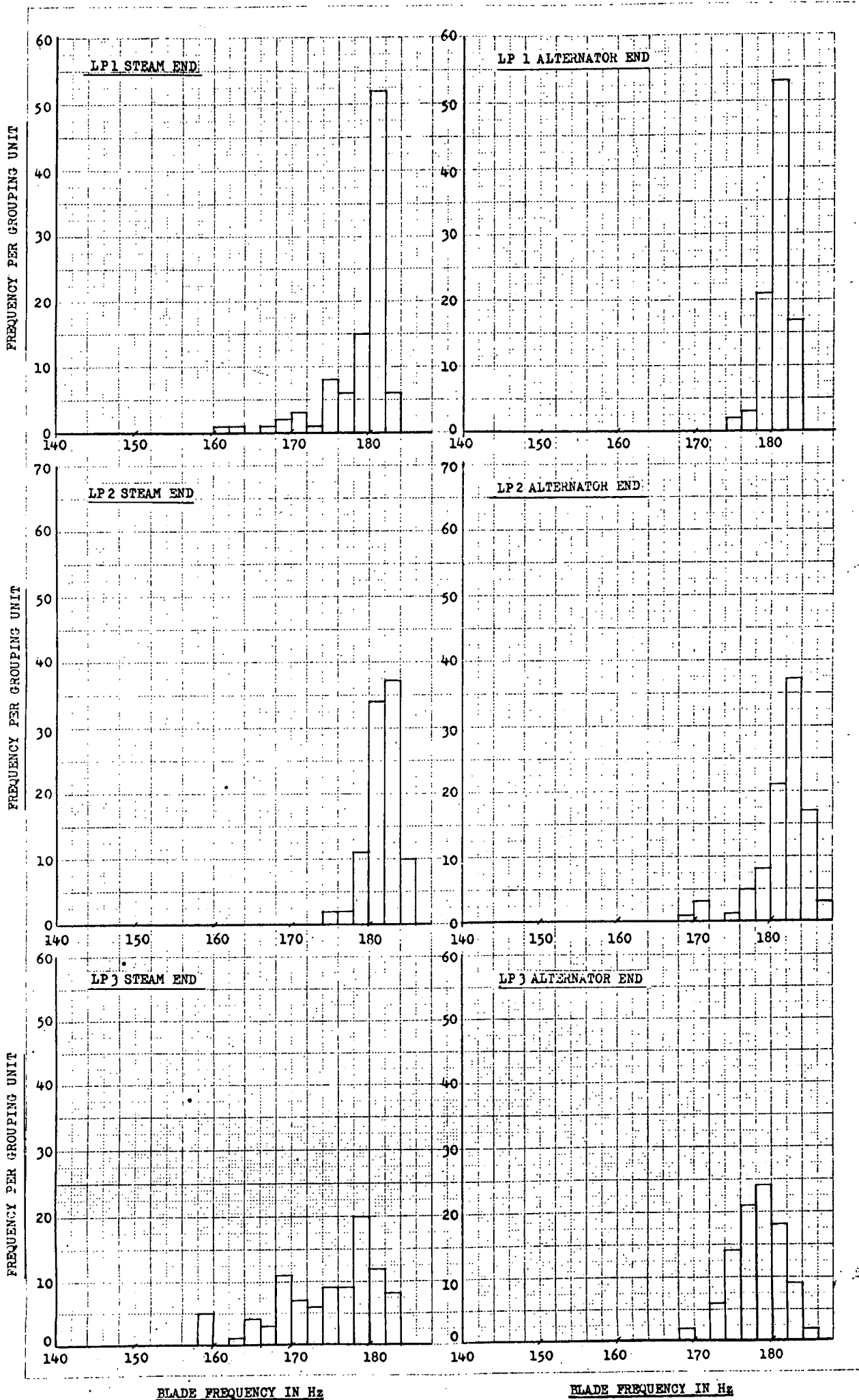

FIG. 34.

FREQUENCY HISTOGRAMS OF STATIC MAIN BLADE FREQUENCIES IN Hz OF MACHINE "A" SET 3.

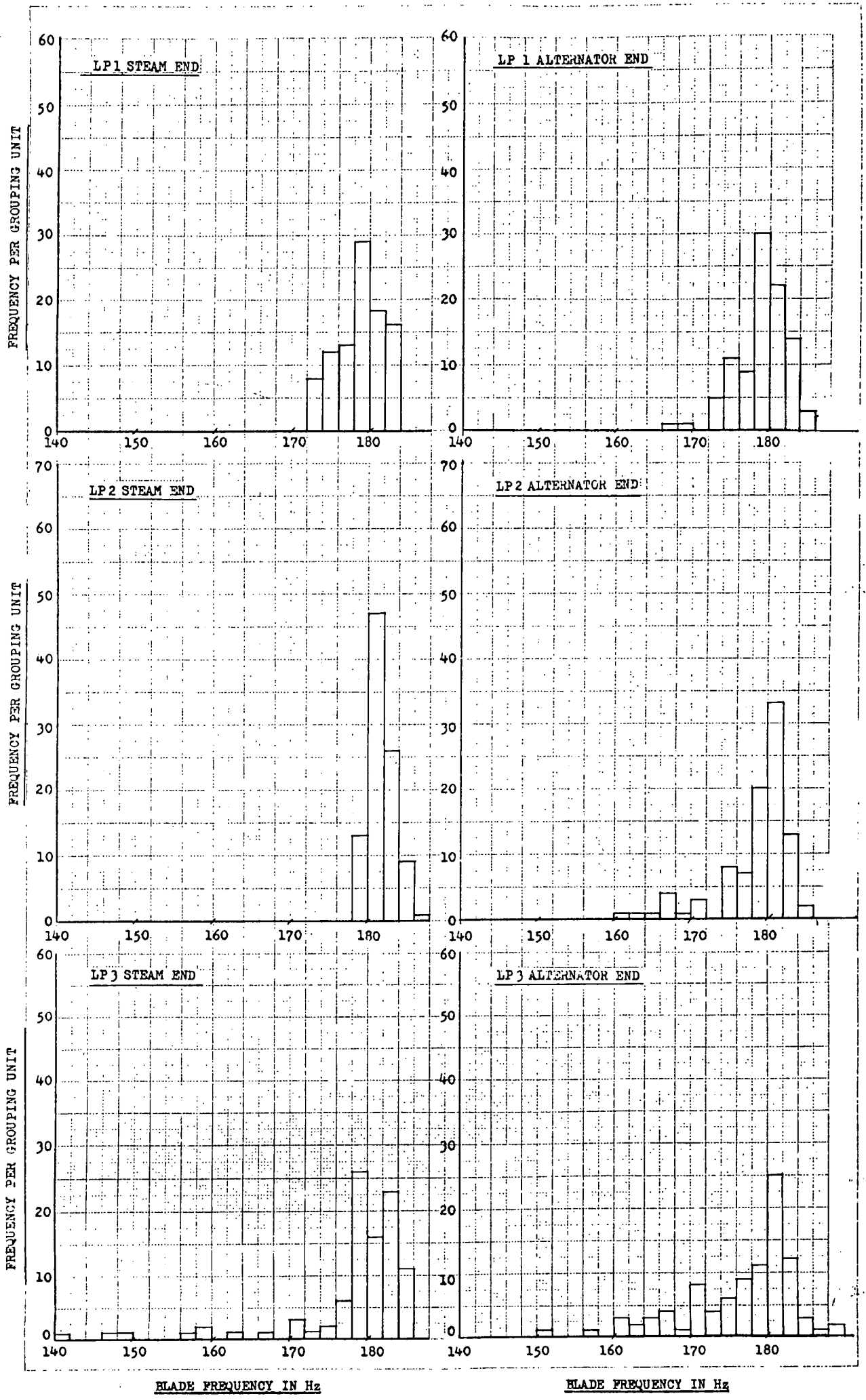

FIG. 35.

FREQUENCY HISTOGRAM OF STATIC MAIN BLADE
FREQUENCIES IN Hz FOR EXPERIMENTAL WHEEL
OF MACHINE "B" (RIVETED ROOT).

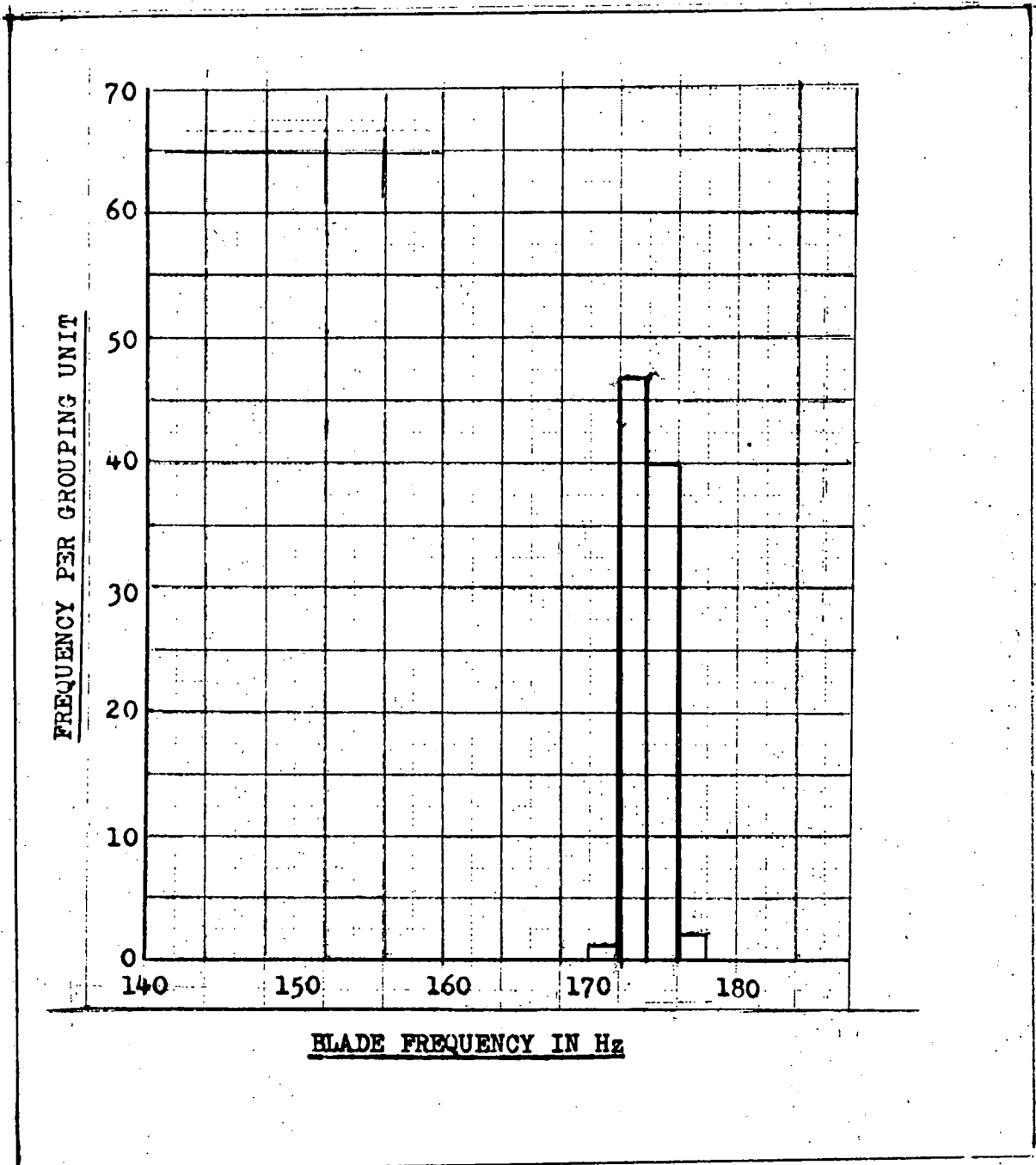

FIG. 36.

FREQUENCY HISTOGRAMS OF STATIC MAIN BLADE FREQUENCIES IN Hz OF MACHINE "B" SET I.

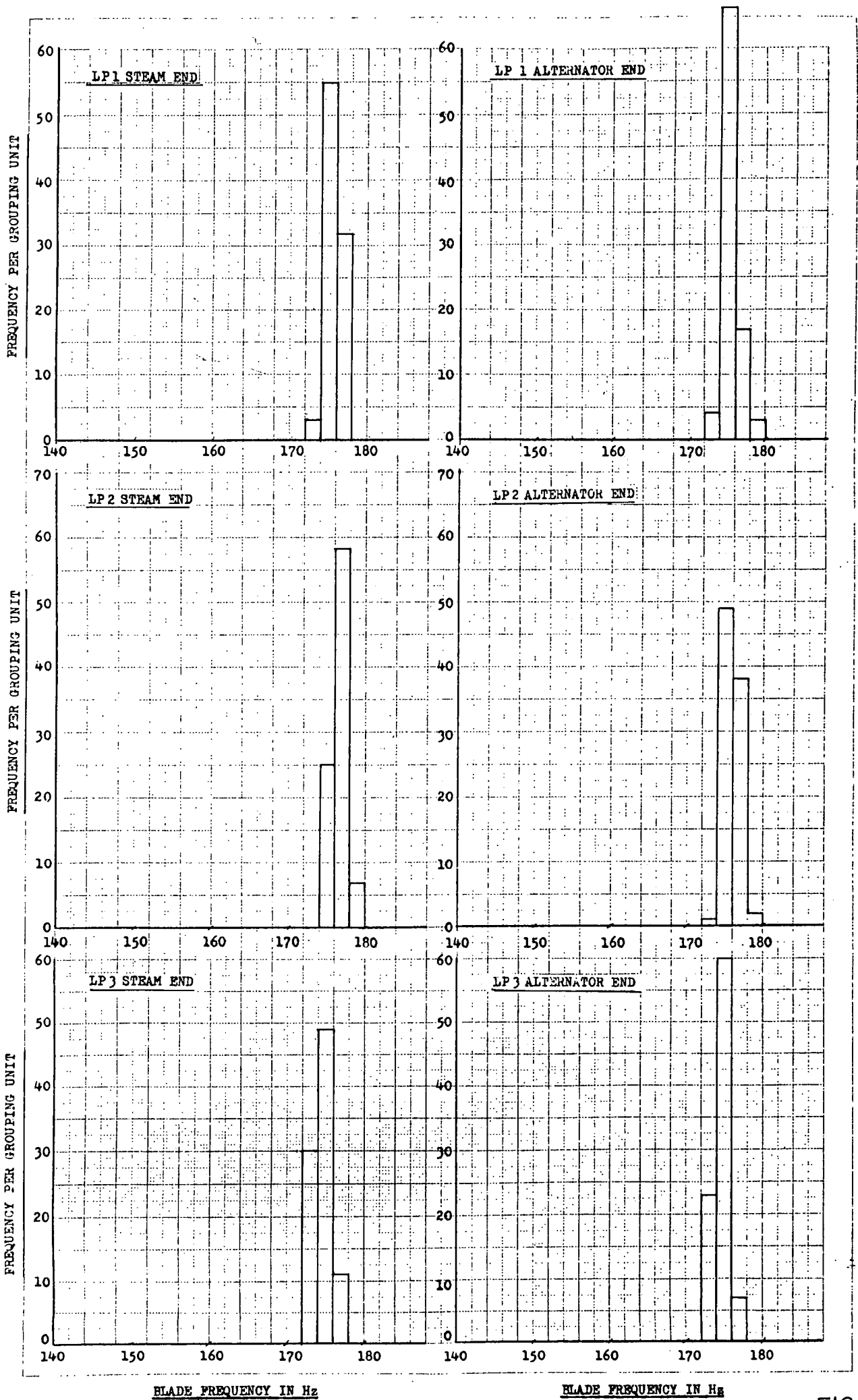
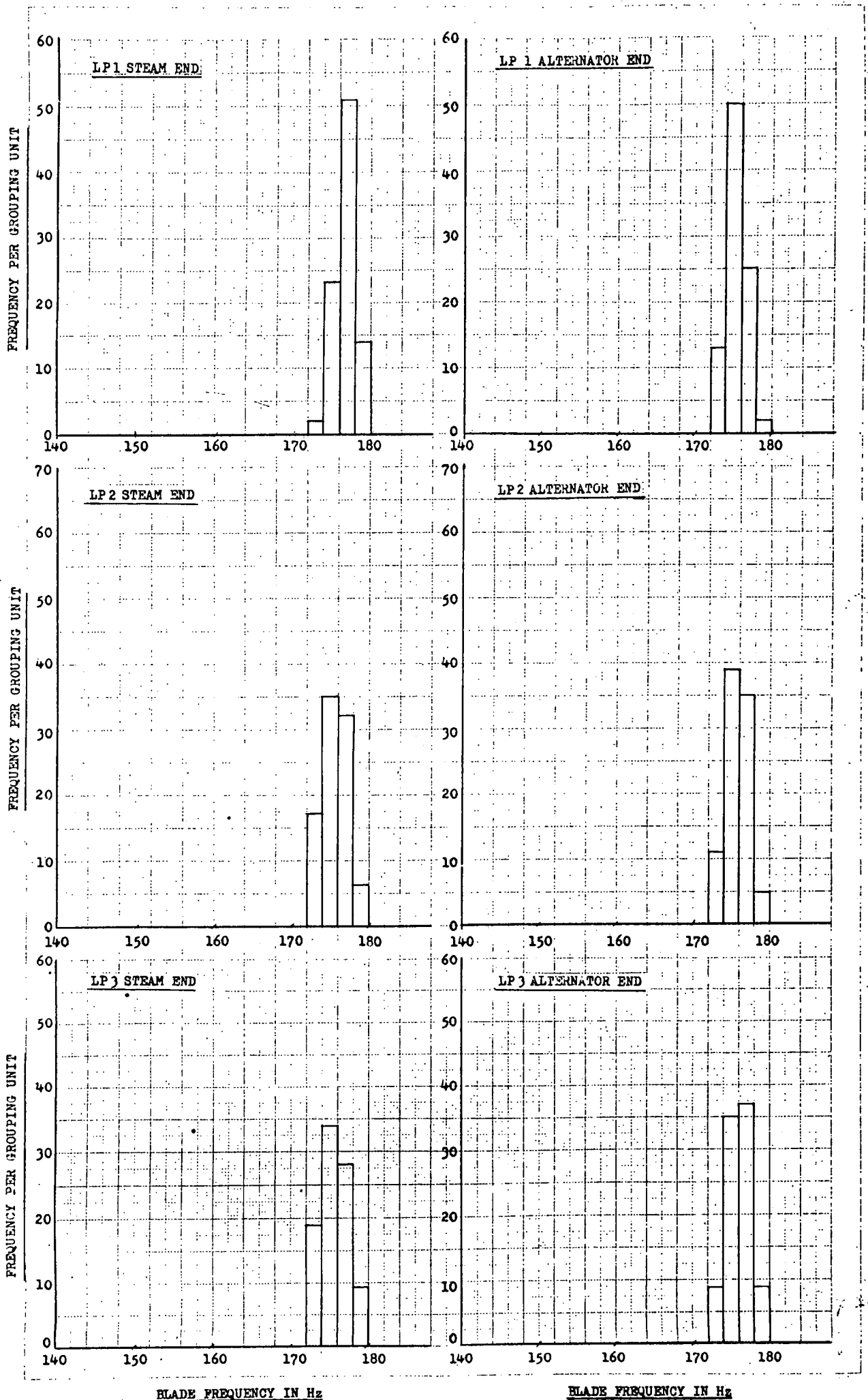

FIG.37.

FREQUENCY HISTOGRAMS OF STATIC MAIN BLADE FREQUENCIES IN Hz OF MACHINE "B" SET 2.



BLADE FREQUENCY IN Hz

BLADE FREQUENCY IN Hz

FIG.38.

FREQUENCY HISTOGRAMS OF STATIC MAIN BLADE FREQUENCIES IN Hz OF MACHINE "B" SET 3.

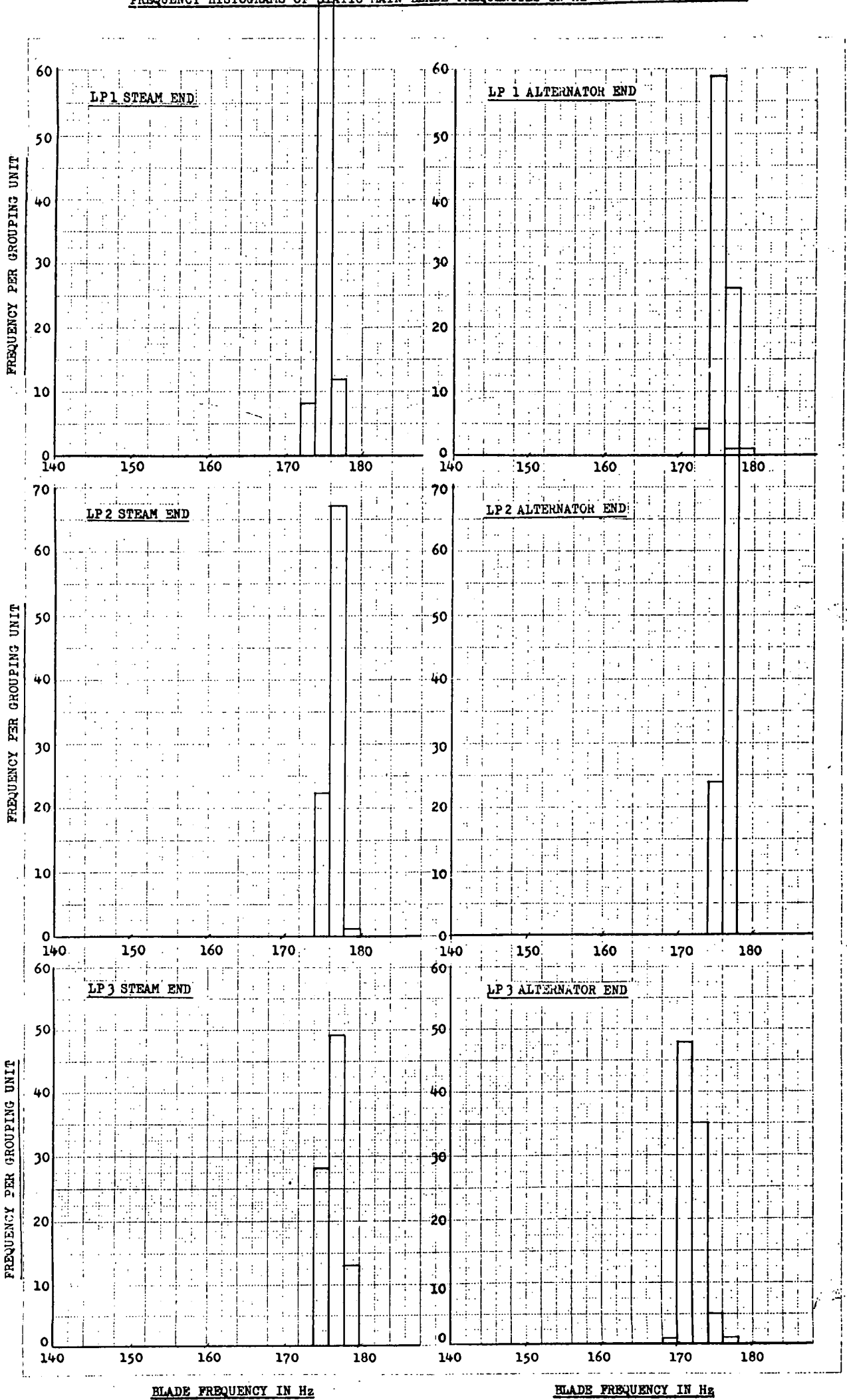

FIG. 39.

FREQUENCY HISTOGRAMS OF STATIC MAIN BLADE FREQUENCIES IN Hz OF MACHINE "B" SET 4.

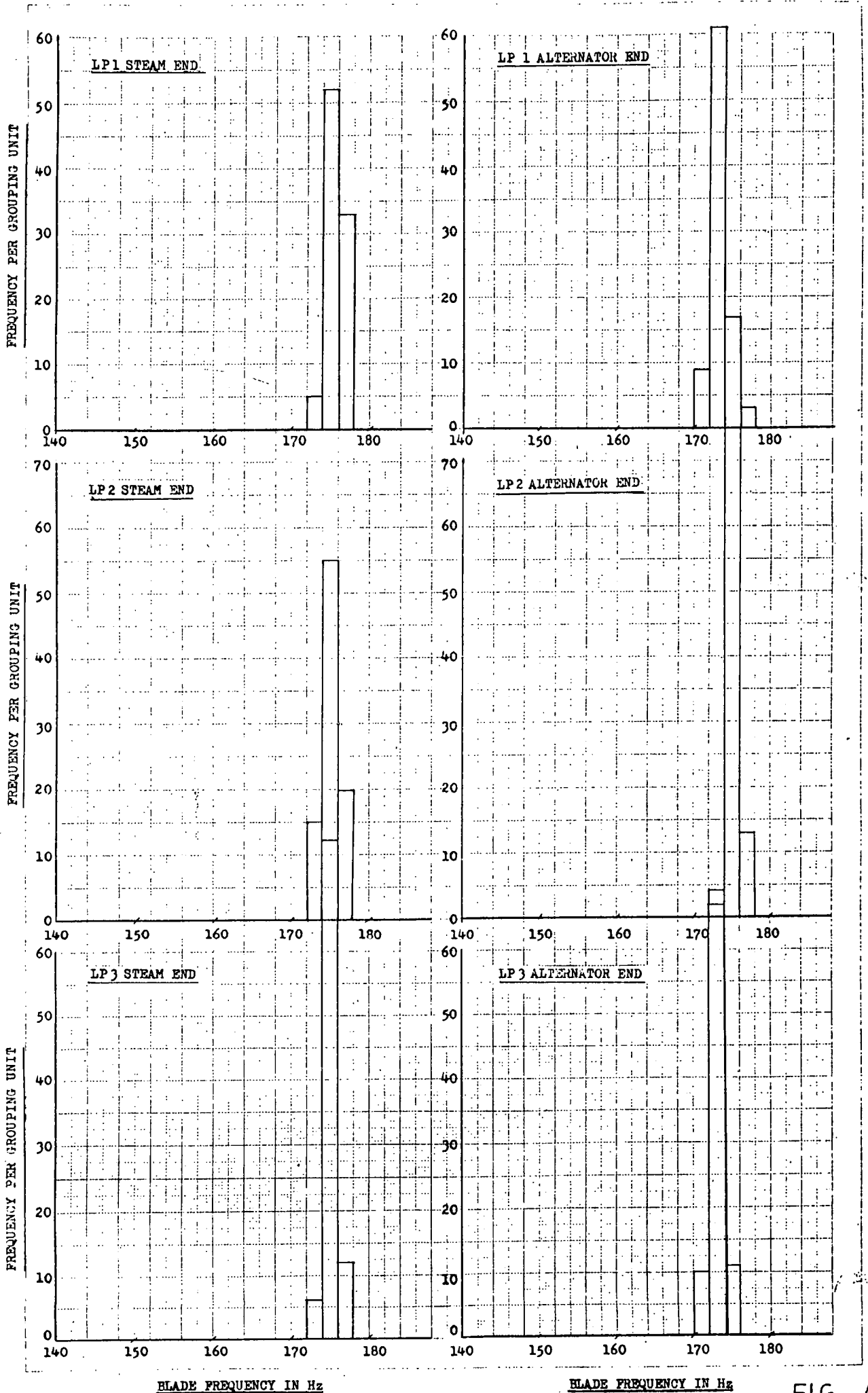

FIG. 40.

A P P E N D I X

TABLE 1

STATIC MAIN BLADE FREQUENCIES IN HZ OF EXPERIMENTAL WHEELFOR MACHINE ANew Before Running

Blade Number	Blade Frequency (Hz)	Blade Number	Blade Frequency (Hz)	Blade Number	Blade Frequency (Hz)
1	174.7	34	171.9	67	172.1
2	174.8	35	177.8	68	173.9
3	176.2	36	177.9	69	173.9
4	173.4	37	172.0	70	177.7
5	174.2	38	178.4	71	177.7
6	176.2	39	173.6	72	178.5
7	176.3	40	172.9	73	175.2
8	176.3	41	173.3	74	175.1
9	176.8	42	173.3	75	175.4
10	174.8	43	172.2	76	175.5
11	174.7	44	171.1	77	176.2
12	176.4	45	171.1	78	176.2
13	179.2	46	171.6	79	176.3
14	180.3	47	175.1	80	177.8
15	174.2	48	171.6	81	177.6
16	176.7	49	175.3	82	177.5
17	179.2	50	175.3	83	178.9
18	179.9	51	175.2	84	172.9
19	178.2	52	174.3	85	172.9
20	186.2	53	171.9	86	173.3
21	174.7	54	171.6	87	173.2
22	180.6	55	171.8	88	173.2
23	180.6	56	175.4	89	170.5
24	172.0	57	179.5	90	176.7
25	172.0	58	173.1	91	176.8
26	177.9	59	178.9	92	176.7
27	182.5	60	178.9	93	172.7
28	172.3	61	177.7	94	175.7
29	172.3	62	175.8	95	177.9
30	167.4	63	172.3	96	177.8
31	173.3	64	165.5		
32	173.5	65	183.3		
33	179.8	66	173.2		

STATIC MAIN BLADE FREQUENCIES IN HZ OF EXPERIMENTAL WHEELFOR MACHINE AJust After Dynamic Test

Blade Number	Blade Frequency (Hz)	Blade Number	Blade Frequency (Hz)	Blade Number	Blade Frequency (Hz)
1	176.5	34	178.8	67	170.9
2	176.7	35	181.1	68	174.0
3	175.1	36	181.2	69	174.7
4	175.1	37	176.8	70	179.5
5	176.1	38	181.4	71	177.8
6	177.8	39	182.5	72	175.9
7	177.7	40	176.1	73	175.9
8	177.4	41	175.6	74	177.8
9	174.3	42	177.6	75	174.8
10	175.6	43	173.2	76	171.7
11	177.6	44	172.0	77	178.9
12	177.6	45	174.1	78	179.2
13	181.0	46	177.5	79	177.7
14	181.1	47	173.2	80	179.4
15	175.4	48	176.6	81	178.5
16	180.7	49	176.6	82	180.2
17	163.6	50	176.5	83	181.1
18	163.4	51	158.4	84	173.7
19	158.1	52	176.3	85	173.6
20	150.6	53	176.4	86	173.2
21	171.6	54	175.2	87	164.0
22	181.9	55	165.1	88	182.7
23	181.9	56	180.5	89	167.6
24	174.4	57	180.6	90	181.0
25	176.9	58	176.1	91	174.4
26	180.1	59	181.1	92	174.5
27	174.6	60	178.4	93	168.2
28	176.3	61	178.8	94	176.6
29	174.0	62	178.7	95	178.4
30	176.3	63	166.8	96	178.7
31	176.3	64	168.9		
32	172.6	65	174.5		
33	172.6	66	171.0		

STATIC MAIN BLADE FREQUENCIES IN HZ OF EXPERIMENTAL WHEELFOR MACHINE ATwo Weeks after Dynamic Test.

Blade Number	Blade Frequency (Hz)	Blade Number	Blade Frequency (Hz)	Blade Number	Blade Frequency (Hz)
1	176.1	34	172.2	67	169.4
2	175.9	35	178.5	68	174.0
3	174.3	36	179.5	69	175.2
4	174.4	37	155.2	70	178.7
5	175.9	38	177.0	71	178.7
6	176.5	39	178.0	72	176.9
7	177.6	40	178.7	73	175.8
8	163.5	41	174.9	74	177.2
9	175.7	42	174.9	75	175.9
10	175.6	43	178.1	76	173.7
11	179.6	44	171.5	77	178.9
12	176.3	45	171.3	78	179.3
13	180.0	46	174.5	79	177.8
14	180.5	47	173.7	80	178.7
15	175.0	48	173.7	81	178.7
16	180.8	49	172.5	82	181.0
17	163.6	50	176.5	83	181.0
18	163.8	51	176.4	84	172.9
19	162.4	52	156.5	85	172.9
20	152.4	53	174.8	86	172.7
21	171.6	54	174.8	87	162.2
22	180.3	55	155.6	88	184.4
23	180.3	56	180.5	89	184.3
24	167.4	57	180.5	90	181.1
25	177.0	58	174.6	91	173.5
26	179.4	59	178.9	92	174.0
27	182.3	60	178.9	93	167.2
28	172.2	61	178.9	94	176.4
29	177.3	62	180.4	95	178.9
30	169.0	63	170.0	96	178.5
31	175.8	64	168.9		
32	175.8	65	173.5		
33	172.2	66	169.4		

TABLE 4STATIC WHEEL FREQUENCIES IN Hz OF EXPERIMENTAL WHEELS.EXPERIMENTAL WHEEL FOR MACHINE "A" (FIRTREE ROOT).

Mode	Test					Mean
	1	2	3	4	5	
0	49.3	49.4	49.1	49.4	49.4	49.3
1	62.0	62.0	61.5	62.2	61.8	61.9
2	87.3	87.8	86.3	88.3	87.8	87.5
3	94.3	95.1	94.4	94.8	94.8	94.7
4	97.6	97.9	96.9	96.2	95.9	96.8
5	99.5	99.7	99.4	99.7	98.5	99.6
6	102.6	102.6	102.4	102.5	101.6	102.3
7	103.8	105.6	105.5	107.4	106.5	105.8
8	107.5	109.4	108.6	109.6	108.5	108.7

EXPERIMENTAL WHEEL FOR MACHINE "B" (RIVETED ROOT).

Mode	Test					Mean
	1	2	3	4	5	
0	47.3	47.2	48.1	45.1	46.0	46.7
1	61.4	62.3	63.2	63.1	60.3	62.0
2	87.2	85.8	89.5	84.0	87.1	86.7
3	94.3	94.3	93.6	93.3	93.0	93.7
4	96.0	95.5	95.6	95.0	97.4	95.9
5	97.7	97.5	97.0	97.8	98.9	97.7
6	99.4	98.2	99.2	100.0	101.1	99.5
7	101.9	102.2	103.2	102.0	101.7	102.2
8	104.6	105.2	106.6	106.3	104.1	105.3

TABLE NO 5

STATIC MAIN BLADE FREQUENCIES IN HZ OF LAST STAGE
L.P STEAM TURBINE MACHINE A, SET I

Blade Number	WHEEL					
	LP1 Steam end	LP1 Alternator end	LP2 Steam end	LP2 Alternator end	LP3 Steam end	LP3 Alternator end.
1	182.4	181.0	180.4	170.0	179.8	180.7
2	181.1	181.0	178.2	183.0	179.3	181.9
3	181.1	180.4	177.8	176.0	179.3	181.9
4	178.8	180.4	178.4	166.0	179.3	178.0
5	178.8	181.2	178.3	186.1	179.0	181.2
6	176.5	182.9	177.7	177.3	178.9	176.8
7	168.2	182.9	156.6	177.4	181.5	177.9
8	171.8	180.5	169.0	164.0	181.5	178.6
9	179.3	180.5	173.1	186.1	178.1	179.2
10	179.2	181.0	218.5	166.4	178.1	179.6
11	179.2	181.0	164.0	166.1	180.4	177.6
12	177.9	180.1	149.0	177.3	177.6	179.6
13	179.3	173.3	148.9	168.1	176.4	179.6
14	180.2	169.3	155.7	169.4	176.9	180.0
15	180.2	170.5	153.5	165.1	181.1	178.5
16	177.7	176.4	187.3	165.1	181.2	176.6
17	177.7	179.2	170.4	180.3	179.4	178.0
18	180.3	178.9	159.6	177.2	175.4	179.4
19	182.5	176.8	153.7	170.0	175.4	180.1
20	182.1	176.8	156.1	175.0	175.4	180.1
21	182.0	180.8	188.2	175.4	175.4	180.1
22	182.0	181.1	152.4	177.6	178.7	180.1
23	179.5	179.8	176.1	172.2	180.5	181.1
24	177.0	179.1	176.1	177.3	181.4	181.2
25	177.0	181.4	176.1	166.2	181.4	181.6
26	181.0	182.5	182.1	166.3	178.6	179.0
27	175.6	181.6	162.8	166.3	181.7	177.0
28	180.0	181.6	162.2	175.8	181.6	175.6
29	180.8	181.5	165.5	175.5	173.8	175.6
30	181.0	183.0	167.5	161.4	179.9	177.7
31	172.0	182.0	179.2	175.5	179.9	178.7
32	177.0	181.0	179.2	170.4	181.8	178.9
33	177.3	183.0	180.3	175.0	181.8	179.1
34	179.6	184.0	175.2	166.6	178.4	181.3
35	179.6	181.0	180.6	179.8	178.7	181.3
36	179.6	182.0	179.9	180.9	181.7	181.3
37	173.8	183.0	180.6	183.5	180.1	183.6
38	180.4	181.0	180.0	182.1	179.7	183.6
39	180.5	178.5	181.9	182.1	179.2	183.5
40	183.0	178.6	179.0	182.1	179.2	182.2
41	183.0	182.5	181.7	184.2	178.8	182.2
42	183.0	177.9	181.7	182.2	178.8	182.2
43	183.0	180.8	181.7	182.2	179.4	182.2
44	180.0	182.8	181.1	180.2	179.4	181.5
45	180.0	182.8	182.1	180.2	180.4	180.7
46	180.6	182.4	179.0	179.8	181.9	180.7
47	180.8	179.0	182.5	170.7	181.4	182.3
48	180.8	178.8	182.5	180.4	175.4	182.3
49	180.8	177.3	179.8	179.0	181.6	175.2
50	177.2	181.1	179.9	166.3	181.6	181.4
51	177.2	176.1	180.7	183.8	181.6	181.4
52	182.6	182.1	177.6	183.3	183.3	181.4
53	182.6	179.6	170.4	188.1	183.0	183.4
54	182.6	179.0	177.3	188.1	181.0	183.4
55	182.6	179.0	173.5	160.3	181.0	184.9
56	179.1	178.0	170.8	202.1	182.6	181.7
57	179.1	178.1	175.1	142.6	182.6	180.1
58	179.1	177.6	174.3	202.0	178.8	180.1
59	179.1	174.7	176.8	166.5	178.8	180.1
60	179.0	175.4	178.0	166.5	183.7	181.2
61	179.3	180.0	176.7	196.8	179.7	181.2
62	179.3	181.4	177.8	168.6	179.7	181.2
63	179.3	181.6	175.9	154.9	178.6	181.2
64	179.4	179.6	179.0	143.0	178.6	184.2
65	182.4	179.8	180.8	180.4	178.6	184.2
66	182.4	183.7	171.2	157.2	178.6	180.7
67	182.4	182.3	162.9	153.9	180.8	180.7
68	179.8	182.6	169.0	166.0	180.9	180.7
69	180.4	184.5	169.2	-	180.6	185.0
70	182.1	184.4	172.2	154.2	180.6	182.6
71	182.1	184.9	145.9	161.6	182.3	181.5
72	175.8	182.0	145.9	176.2	182.3	181.5
73	186.5	181.9	162.3	160.4	182.3	181.5
74	177.8	180.5	173.0	170.6	181.0	181.5
75	177.8	180.2	179.8	166.9	179.7	182.0
76	176.9	180.8	180.0	163.7	179.7	184.8
77	180.0	180.8	180.0	164.8	179.7	180.4
78	178.1	181.0	180.0	183.4	180.6	180.4
79	178.1	180.2	181.4	161.2	180.6	180.4
80	181.7	180.2	181.4	175.9	181.6	183.5
81	181.7	179.1	178.9	167.9	180.7	183.6
82	177.1	181.5	182.0	179.6	180.3	183.0
83	176.2	179.5	178.3	176.0	179.5	181.0
84	179.6	179.5	181.7	180.4	177.2	181.0
85	182.6	179.5	182.0	180.4	177.2	181.0
86	175.9	182.5	176.9	180.3	178.2	181.0
87	175.9	180.9	182.6	174.7	175.0	181.0
88	175.9	180.8	182.6	171.6	180.8	181.0
89	179.7	180.8	183.3	186.0	180.8	181.0
90	179.8	179.9	182.0	169.4	179.6	183.1
91	179.8	179.9	180.9	167.2	179.7	185.1
92	178.5	179.9	181.7	176.0	179.8	183.1
93	178.4	181.6	180.6	183.3	182.1	183.3
94	180.0	181.6	183.6	171.9	178.1	185.3
95	181.9	181.5	179.4	177.1	183.5	185.3
96	182.4	181.0	179.4	177.1	183.6	181.1

STATIC MAIN BLADE FREQUENCIES IN HZ OF LAST STAGE

L.P. STEAM TURBINE MACHINE A, SET 2.

Blade Number	WHEEL					
	LP ₁ Steam end	LP ₁ Alternator end	LP ₂ Steam end	LP ₂ Alternator end	LP ₃ Steam end	LP ₃ Alternator end.
1	181.8	179.7	178.6	185.3	168.9	181.6
2	175.6	179.7	178.6	183.2	176.7	181.5
3	175.6	179.7	178.6	183.2	179.9	180.5
4	174.4	179.7	178.5	185.4	179.3	179.3
5	176.2	180.1	180.3	185.4	177.7	179.2
6	177.2	180.6	180.7	182.2	172.7	179.6
7	180.6	180.6	180.5	182.2	172.7	176.1
8	178.7	180.7	180.5	182.2	172.7	178.1
9	178.8	180.5	183.2	183.5	168.2	180.9
10	181.0	182.4	180.6	183.5	168.2	179.8
11	181.0	180.8	180.6	184.8	168.2	179.6
12	180.8	180.8	182.2	185.5	168.3	178.9
13	180.8	180.8	182.2	183.3	175.5	176.4
14	179.1	181.7	182.2	183.3	175.5	176.8
15	179.1	182.8	183.4	184.9	175.5	178.6
16	181.0	182.8	182.0	186.8	177.0	178.6
17	173.3	182.5	182.0	181.7	176.1	177.5
18	171.6	183.1	182.0	181.3	179.7	173.3
19	169.9	181.6	182.0	181.1	179.9	172.9
20	180.9	181.6	182.5	181.1	180.6	174.5
21	180.9	181.6	183.5	180.7	180.6	173.8
22	176.9	181.5	183.4	180.7	178.1	178.4
23	174.8	180.0	183.3	183.7	178.1	177.8
24	180.2	179.8	181.3	183.7	182.5	178.6
25	169.2	181.4	181.3	180.8	182.5	176.9
26	180.3	181.4	182.3	184.5	179.8	177.6
27	180.3	181.4	181.4	177.4	179.8	176.4
28	180.3	178.0	181.2	180.9	182.0	175.1
29	180.3	178.0	181.5	183.3	181.3	175.8
30	180.8	178.0	183.3	185.1	169.7	176.8
31	181.4	178.0	181.3	185.1	169.7	177.5
32	178.5	178.6	183.4	182.1	175.7	174.8
33	180.6	180.0	181.6	182.1	176.5	168.4
34	180.6	175.2	181.6	185.0	175.4	168.7
35	180.6	175.2	181.5	183.0	174.7	173.3
36	182.3	177.0	179.2	183.0	178.8	174.8
37	182.8	178.0	176.9	182.1	180.4	174.4
38	180.9	178.3	177.3	183.2	180.4	174.0
39	178.3	178.3	180.0	182.1	180.4	174.4
40	175.9	177.7	181.7	180.6	173.6	175.2
41	179.7	179.1	174.9	180.6	175.6	175.9
42	179.7	179.1	175.2	180.6	176.6	176.7
43	179.7	179.5	182.3	180.6	176.6	180.8
44	180.5	180.4	182.2	184.9	173.9	176.3
45	180.5	180.4	182.2	184.9	173.4	177.0
46	180.0	181.7	181.2	184.5	179.1	176.9
47	180.0	181.5	183.8	184.5	178.0	176.9
48	181.4	181.6	183.8	181.1	175.8	176.9
49	181.4	182.6	181.3	180.7	175.8	176.7
50	178.8	179.0	180.6	178.0	178.0	181.3
51	178.9	182.2	179.9	178.0	178.0	182.7
52	178.9	180.8	179.9	176.0	180.8	183.0
53	181.7	180.6	179.4	180.0	180.5	178.9
54	181.3	180.6	179.4	180.0	180.8	173.3
55	181.3	180.6	183.2	180.0	177.2	173.8
56	180.4	182.3	183.2	168.9	177.0	174.7
57	181.8	182.9	182.4	177.9	178.0	175.1
58	180.7	183.8	183.1	175.6	180.2	178.2
59	181.2	183.7	184.2	171.6	182.9	178.2
60	181.2	183.7	184.2	181.9	181.4	178.8
61	181.3	183.8	181.5	183.2	181.0	178.8
62	183.5	183.8	181.5	184.6	183.5	180.8
63	183.5	183.8	180.7	180.7	183.6	180.8
64	183.5	183.3	180.6	176.1	179.8	181.2
65	177.1	180.7	180.6	176.1	179.8	182.7
66	174.3	180.7	181.6	183.6	178.7	182.0
67	179.1	180.7	181.6	183.6	166.6	182.2
68	177.8	181.0	181.4	182.2	166.6	180.8
69	176.6	181.0	185.0	182.2	169.3	180.0
70	175.2	181.0	185.0	185.2	169.3	176.0
71	175.0	181.8	183.6	186.2	169.4	175.0
72	181.0	181.3	183.6	183.3	170.5	180.6
73	181.0	180.9	182.9	183.3	170.9	180.6
74	181.0	180.9	182.1	186.1	170.9	179.7
75	181.0	182.1	182.1	186.1	179.4	179.6
76	181.0	181.7	184.2	185.8	183.0	179.6
77	178.9	181.0	184.4	183.7	183.0	179.6
78	160.5	181.0	182.7	183.7	158.6	183.2
79	180.7	181.5	180.7	183.6	168.1	184.1
80	180.7	181.5	180.7	179.5	163.6	184.1
81	180.7	180.7	181.6	179.8	158.7	183.6
82	180.7	180.7	181.6	171.4	158.7	183.6
83	179.7	178.9	184.2	171.4	158.7	183.8
84	162.5	177.6	184.2	179.8	171.1	180.1
85	170.9	179.0	184.6	179.8	158.1	175.5
86	167.2	179.0	182.3	179.8	165.2	178.1
87	180.5	179.2	181.8	183.6	167.7	178.1
88	180.5	180.2	181.6	183.7	165.1	177.6
89	182.6	180.4	181.5	182.0	178.3	176.7
90	181.7	180.7	182.9	182.0	179.9	181.1
91	181.7	180.7	182.9	182.0	-	181.1
92	181.6	180.8	184.6	180.2	164.4	181.1
93	171.4	180.0	182.8	178.9	165.8	179.6
94	181.0	180.0	181.8	185.0	171.2	176.3
95	181.2	180.0	178.6	183.7	171.5	176.2
96	181.3	180.0	178.6	183.0	171.5	180.6

TABLE NO 7

STATIC MAIN-BLADE FREQUENCIES IN HZ OF LAST STAGE

L.P. STEAM TURBINE MACHINE A SET 3

WHEEL						
Blade Number	LP ₁ Steam end	LP ₁ Alternator end	LP ₂ Steam end	LP ₂ Alternator end	LP ₃ Steam end	LP ₃ Alternator end
1	174.0	178.4	183.9	182.0	183.3	179.3
2	173.9	178.4	181.5	170.6	184.5	180.5
3	177.8	183.2	181.0	174.4	184.5	180.9
4	179.6	182.5	181.0	-	184.5	172.1
5	179.6	182.6	182.7	182.6	184.5	176.8
6	179.8	182.6	179.9	183.3	181.9	182.3
7	182.0	180.5	179.4	181.2	181.7	164.8
8	179.1	180.6	179.4	181.2	181.3	185.0
9	180.1	181.2	181.7	181.2	178.5	177.4
10	180.1	181.7	182.6	181.5	183.0	188.5
11	180.1	182.5	181.9	181.3	183.4	179.6
12	182.8	177.9	184.0	181.8	182.7	179.6
13	180.8	181.5	180.0	182.4	185.4	178.3
14	178.2	181.5	179.8	179.5	184.7	181.2
15	178.0	180.0	181.0	180.1	183.4	170.7
16	178.8	179.9	181.6	181.6	183.1	165.3
17	179.9	179.9	180.9	182.0	183.4	165.3
18	179.9	179.9	180.8	181.4	182.9	178.3
19	180.0	175.7	180.9	191.1	182.1	170.0
20	182.0	175.7	181.5	177.6	183.1	169.0
21	182.7	176.9	182.9	183.4	185.6	172.7
22	182.7	174.7	180.0	194.0	182.9	180.7
23	182.7	179.0	180.0	170.0	181.5	174.8
24	182.7	179.0	180.0	-	148.8	180.6
25	179.4	178.1	179.8	178.5	183.8	181.0
26	176.7	178.1	180.5	181.3	183.2	182.8
27	177.9	178.1	179.6	179.7	181.7	182.8
28	177.9	185.0	178.9	180.6	180.6	182.7
29	177.9	167.2	179.1	182.8	177.7	171.9
30	173.8	169.7	182.3	179.7	177.7	177.9
31	177.8	174.6	183.4	178.7	179.4	180.7
32	180.0	176.5	181.7	178.7	179.4	180.7
33	175.8	176.5	181.7	176.8	178.5	181.3
34	175.5	176.5	181.6	181.9	181.8	181.3
35	177.1	178.1	180.6	-	180.0	181.3
36	179.8	178.1	179.9	176.7	180.0	174.3
37	179.8	179.5	180.5	177.2	182.0	181.5
38	179.8	179.5	179.8	180.6	179.0	181.5
39	179.8	180.8	181.3	181.4	179.7	172.8
40	179.8	180.8	184.0	181.3	182.1	178.5
41	182.3	179.3	184.0	181.4	177.3	177.4
42	175.8	179.5	181.7	181.0	177.3	177.4
43	175.6	181.5	180.8	180.2	179.0	176.7
44	174.5	181.5	180.8	178.2	179.1	-
45	179.8	181.5	180.8	175.8	179.1	183.4
46	179.8	181.5	181.3	175.9	183.1	160.2
47	174.8	177.9	182.4	181.3	183.1	173.2
48	173.2	177.9	182.6	181.3	182.7	166.2
49	179.3	177.9	183.8	180.0	184.7	166.8
50	182.6	177.9	182.1	178.4	183.4	183.7
51	182.9	178.6	181.9	178.4	183.3	162.2
52	183.2	179.9	181.7	179.6	184.6	-
53	183.2	179.9	182.9	179.7	184.6	150.8
54	183.2	173.2	181.2	180.9	182.5	162.5
55	181.2	181.5	184.2	180.9	182.3	166.5
56	181.2	182.9	184.0	180.9	184.1	182.7
57	179.7	180.4	184.2	178.2	178.6	162.2
58	179.7	180.2	183.6	178.2	182.0	-
59	179.8	180.2	184.0	181.5	178.3	150.8
60	180.0	182.2	181.8	181.5	170.0	162.5
61	179.3	181.9	187.5	182.5	178.7	166.5
62	180.3	184.4	181.4	182.2	178.0	178.7
63	180.3	184.4	178.9	182.1	178.0	179.0
64	180.3	183.4	178.0	182.4	178.0	180.4
65	179.6	183.3	181.0	184.1	179.0	180.4
66	178.1	181.0	181.9	181.8	180.6	178.1
67	177.9	181.4	180.9	175.9	180.6	181.2
68	175.0	183.9	180.8	179.5	172.2	174.5
69	181.6	183.9	180.5	-	177.3	174.5
70	181.3	180.0	182.5	174.1	179.3	180.0
71	182.0	179.3	182.5	168.1	179.3	180.0
72	179.0	182.4	183.8	167.1	178.6	180.9
73	180.1	182.4	182.2	-	174.5	174.6
74	182.0	182.4	183.6	-	167.7	182.5
75	182.2	174.7	183.1	-	181.7	182.5
76	177.2	175.3	182.9	-	181.7	180.5
77	172.3	179.0	181.0	-	179.0	179.6
78	172.6	175.4	180.0	180.4	179.0	181.5
79	172.6	175.4	180.0	-	179.0	180.9
80	173.0	172.6	180.0	170.5	180.3	180.9
81	175.0	172.6	179.8	182.9	179.2	183.3
82	176.0	174.5	182.5	175.5	170.8	183.3
83	178.6	178.6	182.8	179.1	157.0	171.4
84	175.5	178.6	181.8	185.8	177.0	171.4
85	175.5	179.1	181.8	183.4	174.5	170.4
86	176.5	179.1	181.8	-	158.2	157.4
87	176.5	181.6	181.6	179.9	158.0	167.3
88	176.5	174.3	182.7	178.6	140.0	177.6
89	178.5	178.3	182.3	174.7	146.0	185.1
90	178.5	178.0	181.2	174.5	181.0	187.4
91	172.9	178.5	184.4	-	181.6	189.7
92	174.7	174.1	184.6	181.6	179.5	174.8
93	180.7	173.8	181.0	177.6	179.5	184.6
94	180.7	178.6	181.0	177.6	179.5	171.7
95	180.4	172.9	183.9	180.3	171.5	171.7
96	178.9	178.6	184.0	180.3	163.5	-

TABLE 8

STATIC WHEEL VIBRATION FREQUENCIES IN HZ OF MACHINE A SET I

Mode	STAGE					
	LP1		LP2		LP3	
	Steam end	Alternator end	Steam end	Alternator end	Steam end	Alternator end
0	43.2	43.3	43.5	43.5	43.5	43.5
0	45.3	45.2	45.5	45.4	45.5	45.5
1	56.0	57.2	57.1	55.7	55.7	57.1
2	79.6	81.6	81.8	80.5	80.5	81.8
3	93.0	94.6	96.1	93.5	93.5	96.1
4	96.8	99.2	99.9	97.7	97.7	99.9
5	98.8	100.5	101.7	100.2	100.2	101.7
6	100.4	101.8	103.9	101.9	101.9	103.9
7	101.6	103.9	106.2	104.6	104.6	106.2
8	105.4	106.8	108.7	106.6	106.6	108.7

TABLE 9

STATIC WHEEL VIBRATION FREQUENCIES IN Hz OF MACHINE A SET II

Mode	STAGE					
	LP1		LP2		LP3	
	Steam end	Alternator end	Steam end	Alternator end	Steam end	Alternator end
0	43.2	43.0	43.7	43.6	42.9	43.2
0	45.4	45.3	46.0	45.9	45.0	44.9
1	55.3	55.9	55.9	56.6	55.2	55.8
2	78.8	79.6	79.7	80.6	79.5	80.1
3	93.5	96.6	93.6	96.9	93.3	95.2
4	97.3	-	96.1	99.6	96.7	97.4
5	98.1	100.0	98.3	101.8	99.7	100.1
6	100.7	102.6	100.5	103.2	101.8	101.6
7	102.3	103.9	102.9	105.9	103.8	104.0
8	104.6	107.3	105.9	108.6	107.5	106.5

TABLE 10STATIC WHEEL VIBRATION FREQUENCIES IN Hz OF MACHINE A SET III

Mode	STAGE					
	LP1		LP2		LP3	
	Steam end	Alternator end	Steam end	Alternator end	Steam end	Alternator end
0	43.4	43.2	43.7	43.9	43.0	43.3
0	45.3	45.6	45.7	45.7	45.0	45.4
1	55.8	55.7	55.1	54.5	55.2	55.9
2	80.0	79.5	76.9	77.2	77.8	78.5
3	94.2	96.5	93.6	94.0	94.5	95.2
4	96.2	98.2	96.8	97.9	97.0	97.5
5	100.3	Not found	98.8	101.1	100.2	100.2
6	102.4	101.4	100.0	102.8	100.2	102.5
7	105.1	103.9	102.9	104.8	105.5	105.5
8	107.5	106.4	105.7	107.2	108.6	108.6

STATIC WHEEL FREQUENCIES IN Hz OF MACHINE "A"
(FIRTREE) FOR VARIOUS NODAL DIAMETERS

0 - NODAL DIAMETERS

Test results from production wheels						
Experimental Wheel	Wheel 1	Wheel 2	Wheel 3	Wheel 4	Wheel 5	Wheel 6
49.3	45.2	43.2	41.9	41.6	43.6	43.7
49.4	43.2	43.3	44.0	41.6	43.6	43.7
49.1	43.3	43.2	43.7	41.7	43.7	43.8
49.4	45.2	43.2	43.9	43.9	43.7	43.7
49.4	43.3	43.2	41.6	41.8	43.3	43.2

1 - NODAL DIAMETERS

Test results from production wheels						
Experimental Wheel	Wheel 1	Wheel 2	Wheel 3	Wheel 4	Wheel 5	Wheel 6
62.0	57.2	56.1	53.2	54.2	56.5	56.0
62.0	57.1	55.3	54.2	54.6	56.5	55.8
61.5	56.5	55.4	53.2	56.5	56.5	56.0
62.2	57.0	56.0	54.2	54.5	56.5	56.0
61.8	57.0	55.4	53.1	56.5	56.5	56.0

2 - NODAL DIAMETERS

Test results from production wheels						
Experiment Wheel	Wheel 1	Wheel 2	Wheel 3	Wheel 4	Wheel 5	Wheel 6
87.3	81.1	79.6	78.2	79.8	80.7	79.7
87.8	81.5	79.7	78.2	80.9	80.5	79.7
86.3	80.5	79.8	80.3	80.1	80.5	79.6
88.3	81.6	79.8	78.0	83.1	80.5	79.6
87.3	81.6	79.8	78.9	83.9	80.5	79.6

STATIC WHEEL FREQUENCIES IN Hz OF MACHINE "A"
(FIRTREE) FOR VARIOUS NODAL DIAMETERS

3 - NODAL DIAMETERS

Test results from production wheels						
Experimental Wheel	Wheel 1	Wheel 2	Wheel 3	Wheel 4	Wheel 5	Wheel 6
94.3	96.2	93.0	92.6	93.0	97.8	93.8
95.1	96.2	92.8	91.1	92.0	98.2	93.4
94.4	97.4	93.1	93.9	95.9	98.2	93.5
94.8	96.8	93.1	93.9	96.4	98.4	93.5
94.8	96.0	93.1	93.9	96.0	98.4	93.5

4 - NODAL DIAMETERS

Test results from production wheels						
Experimental Wheel	Wheel 1	Wheel 2	Wheel 3	Wheel 4	Wheel 5	Wheel 6
97.6	98.8	94.8	95.5	98.5	100.4	96.5
97.6	98.8	96.1	92.7	98.7	98.8	95.7
96.9	99.5	94.8	95.0	98.7	99.6	96.1
96.2	98.8	96.2	95.0	98.7	99.6	96.1
95.9	99.2	96.2	95.0	98.7	99.6	96.1

5 - NODAL DIAMETERS

Test results from production wheels						
Experimental Wheel	Wheel 1	Wheel 2	Wheel 3	Wheel 4	Wheel 5	Wheel 6
99.5	100.7	98.8	97.5	100.1	101.7	98.1
99.7	100.5	98.2	94.7	99.9	100.1	99.3
99.4	100.5	99.1	99.0	99.6	100.5	97.6
99.7	100.5	99.1	99.0	99.1	100.5	98.3
98.5	100.5	99.1	99.0	99.1	100.5	98.3

STATIC WHEEL FREQUENCIES IN Hz OF MACHINE "A"
(FIR TREE) FOR VARIOUS NODAL DIAMETERS

6 - NODAL DIAMETERS

Test results from production wheels						
Experimental Wheel	Wheel 1	Wheel 2	Wheel 3	Wheel 4	Wheel 5	Wheel 6
102.6	102.0	100.2	99.9	101.1	103.2	100.7
102.6	102.1	100.2	99.9	101.9	101.8	100.7
102.4	101.5	100.8	100.0	101.9	102.0	102.2
102.5	101.8	100.8	100.0	101.9	101.8	100.5
101.6	101.8	100.8	100.0	101.9	101.8	100.5

7 - NODAL DIAMETERS

Test results from production wheels						
Experimental Wheel	Wheel 1	Wheel 2	Wheel 3	Wheel 4	Wheel 5	Wheel 6
103.8	104.2	102.4	102.0	102.3	105.7	103.0
105.6	104.2	102.6	102.9	102.7	106.1	103.0
105.5	103.6	102.8	102.0	102.7	105.8	102.8
107.4	103.9	103.0	102.9	102.7	105.9	102.9
106.5	103.9	103.0	102.9	102.7	105.9	102.9

8 - NODAL DIAMETERS

Test results from production wheels						
Experimental Wheel	Wheel 1	Wheel 2	Wheel 3	Wheel 4	Wheel 5	Wheel 6
107.5	107.4	105.0	107.0	104.4	108.9	105.6
109.4	106.8	105.1	107.0	104.5	108.2	106.0
108.6	106.8	106.1	107.0	104.6	108.7	106.1
109.6	106.8	106.0	107.0	105.0	108.6	105.9
108.5	106.8	106.0	107.0	105.0	108.6	105.9

TABLE 14

STATIC MAIN BLADE FREQUENCIES IN Hz OF PRODUCTION WHEEL 1FOR MACHINE A* (LAST STAGE)NEW JUST AFTER MANUFACTURE

Blade Number	Blade Frequency (Hz)	Blade Number	Blade Frequency (Hz)	Blade Number	Blade Frequency (Hz)
1	173.4	34	182.2	67	177.2
2	173.3	35	179.4	68	177.8
3	176.3	36	176.8	69	177.8
4	176.2	37	176.8	70	177.7
5	175.2	38	176.8	71	176.2
6	175.2	39	179.1	72	174.4
7	178.3	40	180.4	73	170.3
8	177.7	41	178.1	74	177.8
9	177.2	42	176.8	75	182.2
10	176.6	43	173.2	76	182.3
11	171.4	44	181.2	77	182.3
12	174.6	45	185.4	78	181.6
13	178.2	46	177.8	79	182.0
14	172.1	47	176.2	80	175.1
15	172.6	48	176.2	81	176.3
16	170.9	49	176.2	82	176.1
17	179.5	50	175.8	83	177.3
18	171.8	51	175.8	84	177.3
19	176.8	52	175.8	85	179.9
20	170.0	53	176.7	86	179.9
21	176.8	54	176.4	87	179.8
22	170.5	55	181.0	88	181.8
23	184.5	56	182.5	89	182.2
24	171.7	57	182.9	90	180.1
25	171.2	58	179.0	91	180.6
26	172.0	59	176.3	92	181.0
27	181.1	60	178.9	93	179.4
28	182.7	61	178.0	94	179.4
29	182.7	62	177.9	95	178.0
30	180.1	63	177.9	96	173.3
31	180.1	64	178.4		
32	178.4	65	177.5		
33	178.8	66	177.2		

TABLE 15

STATIC MAIN BLADE FREQUENCIES IN Hz OF PRODUCTION WHEEL 1
FOR MACHINE A* (LAST STAGE)

SIX MONTHS AFTER MANUFACTURE BEFORE INSTALLATION

Blade Number	Blade Frequency (Hz)	Blade Number	Blade Frequency (Hz)	Blade Number	Blade Frequency (Hz)
1	178.0	34	185.2	61	171.8
2	162.4	35	181.6	68	178.9
3	171.4	36	177.1	69	178.9
4	174.9	37	183.1	70	178.9
5	174.9	38	181.3	71	177.4
6	177.5	39	183.8	72	175.4
7	177.5	40	183.6	73	172.7
8	172.4	41	184.0	74	185.5
9	162.1	42	177.9	75	183.1
10	185.1	43	172.0	76	183.1
11	171.6	44	172.0	77	181.8
12	168.6	45	177.5	78	181.8
13	173.8	46	175.2	79	181.8
14	173.8	47	173.7	80	181.8
15	173.8	48	173.7	81	177.8
16	173.8	49	168.8	82	177.8
17	159.9	50	174.4	83	185.2
18	166.1	51	177.5	84	176.6
19	166.1	52	172.8	85	179.2
20	176.7	53	172.8	86	180.2
21	169.6	54	163.7	87	180.2
22	174.0	55	183.9	88	180.2
23	175.5	56	183.9	89	183.2
24	177.8	57	183.9	90	168.2
25	177.8	58	177.6	91	182.1
26	168.8	59	179.9	92	174.5
27	184.1	60	178.9	93	174.6
28	184.9	61	178.9	94	180.1
29	176.2	62	178.9	95	169.6
30	184.8	63	178.9	96	169.6
31	184.8	64	178.9		
32	182.0	65	173.2		
33	182.0	66	173.2		

TABLE 16

STATIC MAIN BLADE FREQUENCIES IN Hz OF PRODUCTION WHEEL 2FOR MACHINE A* (LAST STAGE)NEW JUST AFTER MANUFACTURE

Blade Number	Blade Frequency (Hz)	Blade Number	Blade Frequency (Hz)	Blade Number	Blade Frequency (Hz)
1	169.9	34	160.2	67	165.6
2	167.8	35	159.9	68	140.3
3	164.5	36	161.1	69	153.9
4	161.7	37	166.0	70	165.6
5	171.4	38	166.0	71	148.0
6	179.4	39	161.6	72	154.8
7	171.1	40	158.2	73	158.5
8	165.4	41	147.2	74	160.3
9	163.0	42	154.5	75	161.5
10	177.0	43	178.7	76	158.9
11	171.7	44	150.5	77	158.6
12	171.4	45	189.2	78	170.9
13	176.7	46	190.8	79	157.2
14	177.5	47	185.3	80	161.0
15	178.8	48	192.2	81	179.4
16	168.3	49	147.6	82	172.1
17	159.0	50	172.0	83	158.9
18	157.0	51	163.0	84	174.3
19	176.5	52	167.1	85	173.8
20	163.2	53	164.3	86	170.5
21	159.9	54	164.3	87	158.8
22	159.2	55	176.7	88	147.1
23	164.4	56	170.5	89	162.2
24	165.9	57	178.3	90	174.5
25	165.6	58	169.8	91	158.8
26	172.5	59	171.0	92	159.2
27	157.7	60	169.4	93	175.8
28	159.7	61	159.1	94	168.2
29	159.2	62	166.4	95	168.2
30	160.4	63	166.4	96	169.5
31	164.5	64	166.8		
32	161.3	65	164.4		
33	161.7	66	149.4		

TABLE 17

STATIC MAIN BLADE FREQUENCIES IN Hz OF PRODUCTION WHEEL 2
FOR MACHINE A * (LAST STAGE)

SIX MONTH AFTER MANUFACTURE BEFORE INSTALLATION

Blade Number	Blade Frequency (Hz)	Blade Number	Blade Frequency (Hz)	Blade Number	Blade Frequency (Hz)
1	177.2	34	165.6	67	204.3
2	175.7	35	168.4	68	204.3
3	175.4	36	163.6	69	193.0
4	177.4	37	167.8	70	200.0
5	179.1	38	168.8	71	199.9
6	179.1	39	161.2	72	197.6
7	178.7	40	158.5	73	195.8
8	176.3	41	155.4	74	203.7
9	176.8	42	156.0	75	208.9
10	179.8	43	153.0	76	208.9
11	179.4	44	187.6	77	214.5
12	179.8	45	175.6	78	174.4
13	182.3	46	165.6	79	179.1
14	183.2	47	166.7	80	174.2
15	183.2	48	184.3	81	183.9
16	180.3	49	171.1	82	180.9
17	175.7	50	180.2	83	209.4
18	174.1	51	178.5	84	159.5
19	174.1	52	176.0	85	159.2
20	168.8	53	176.0	86	171.3
21	164.4	54	165.6	87	171.3
22	168.8	55	178.7	88	168.7
23	168.4	56	178.7	89	168.7
24	165.1	57	180.6	90	167.5
25	165.1	58	176.2	91	166.0
26	163.8	59	176.2	92	165.2
27	158.4	60	180.8	93	180.5
28	165.0	61	162.9	94	180.5
29	163.7	62	164.5	95	180.6
30	163.7	63	165.6	96	180.6
31	163.7	64	180.8		
32	162.6	65	170.7		
33	162.6	66	198.1		

TABLE 18

STATIC MAIN BLADE FREQUENCIES IN HZ OF EXPERIMENTAL WHEELFOR MACHINE B

Blade Number	Blade Frequency (Hz)	Blade Number	Blade Frequency (Hz)	Blade Number	Blade Frequency (Hz)
1	172.4	34	173.3	67	171.9
2	174.5	35	173.8	68	172.0
3	174.5, 174.6	36	173.5	69	173.2
4	174.5	37	172.7	70	173.2
5	174.0	38	173.6	71	173.2
6	174.9	39	175.3	72	172.2
7	173.1	40	175.0	73	173.4
8	173.7	41	175.2	74	174.2
9	173.7	42	173.5	75	172.1
10	174.8	43	173.5	76	175.2
11	174.5	44	174.6	77	172.7
12	174.5	45	172.7	78	173.4
13	172.0	46	173.7	79	175.2
14	174.8	47	174.5	80	174.9
15	174.8	48	174.7	81	174.7
16	174.5	49	174.8	82	173.2
17	174.6	50	174.6	83	174.9
18	173.7	51	173.5	84	175.5
19	173.4	52	175.9	85	173.4
20	173.6	53	176.0	86	174.5
21	175.0	54	176.0	87	172.1
22	174.8	55	173.5	88	174.5
23	173.6	56	172.8	89	173.2
24	173.5	57	173.3	90	173.2
25	172.8	58	173.6		
26	173.5	59	173.1		
27	173.3	60	174.5		
28	174.8	61	174.7		
29	172.7	62	174.7		
30	174.8	63	174.7		
31	173.5	64	172.4		
32	173.5	65	172.4		
33	172.4	66	174.7		

TABLE NO. 19

STATIC MAIN BLADE FREQUENCIES IN HZ OF LAST STAGE

L.P. STEAM TURBINE MACHINE 8, SET 1

Blade Number	WHEEL					
	LP ₁ Steam end	LP ₁ Alternator end	LP ₂ Steam end	LP ₂ Alternator end	LP ₃ Steam end	LP ₃ Alternator end
1	175.5	173.8	175.6	177.7	172.9	173.1
2	175.4	175.8	175.9	176.9	173.3	172.8
3	175.2	174.2	176.1	176.2	173.4	172.0
4	175.1	174.0	175.9	176.2	172.6	176.0
5	175.3	174.5	175.9	176.1	172.6	175.2
6	175.3	174.8	176.3	176.3	172.6	175.2
7	174.5	174.7	176.9	176.2	172.6	174.6
8	174.9	175.0	175.7	177.2	173.1	173.4
9	175.7	174.2	176.7	176.3	172.9	173.0
10	176.0	174.9	176.2	176.8	175.2	173.7
11	174.9	175.3	175.3	175.3	174.3	173.4
12	175.1	175.3	176.7	175.7	174.1	175.5
13	175.0	175.3	176.8	176.0	173.1	175.3
14	174.7	174.8	174.8	174.9	173.7	175.5
15	174.9	175.2	176.5	174.5	173.8	175.2
16	174.9	175.5	178.4	174.9	173.2	175.2
17	174.6	175.9	178.6	175.3	174.5	175.1
18	174.6	175.1	176.3	175.0	175.7	175.7
19	174.6	175.4	175.5	175.0	174.7	174.7
20	174.4	174.7	175.8	175.0	175.9	174.7
21	175.5	175.6	177.1	175.4	176.0	175.2
22	175.3	178.9	177.2	175.4	176.0	175.1
23	176.2	176.4	177.2	175.5	174.9	174.8
24	176.9	176.4	176.5	175.3	174.9	174.4
25	176.7	176.9	178.0	175.4	175.3	175.8
26	176.3	175.4	175.0	175.4	176.3	175.6
27	176.6	177.8	177.9	177.7	175.9	175.8
28	175.7	175.5	177.1	177.3	175.9	174.0
29	176.0	175.1	174.6	177.6	176.1	174.9
30	177.0	174.9	177.0	177.1	176.2	175.0
31	176.3	174.8	176.7	176.8	174.8	174.2
32	176.2	174.6	175.9	176.7	174.8	174.2
33	176.2	175.1	177.2	174.0	175.3	174.5
34	175.8	175.2	176.9	175.1	175.3	173.9
35	175.7	175.4	176.9	175.4	174.4	174.7
36	176.3	175.3	175.9	175.3	175.9	175.9
37	176.2	174.9	177.8	174.9	174.5	175.8
38	176.8	174.5	176.3	174.9	174.8	175.6
39	176.7	174.3	176.3	173.9	175.9	176.5
40	175.6	174.0	176.5	174.8	176.0	175.6
41	175.8	173.1	176.3	175.4	174.6	175.3
42	174.1	173.1	175.9	176.0	174.7	175.3
43	174.3	174.0	176.1	175.1	175.0	174.8
44	175.1	175.0	178.4	176.3	175.0	174.9
45	175.1	173.8	177.2	175.6	173.6	174.9
46	176.4	174.5	177.9	175.5	176.2	175.5
47	175.9	175.2	178.0	175.7	176.2	176.7
48	176.4	175.4	175.6	175.6	173.8	174.1
49	176.3	175.8	177.3	175.6	174.4	173.5
50	176.3	175.7	176.1	176.9	174.4	173.8
51	176.8	175.0	177.8	175.7	172.7	174.4
52	173.4	178.0	177.7	176.5	172.9	176.6
53	175.4	178.1	177.8	177.4	173.3	174.6
54	176.2	176.8	177.8	174.7	173.1	174.6
55	176.3	175.7	177.2	175.9	173.2	173.9
56	176.3	178.5	177.2	175.9	174.5	174.0
57	176.4	176.0	176.0	175.9	174.2	174.2
58	175.6	175.8	176.0	176.5	174.1	174.1
59	175.6	173.8	177.0	177.9	174.3	175.5
60	176.4	175.6	177.2	174.2	174.3	175.0
61	176.4	175.6	176.0	174.2	174.9	174.7
62	175.8	175.1	176.0	174.2	173.9	174.8
63	175.8	175.1	175.8	174.1	173.8	174.7
64	176.2	175.3	175.6	174.8	173.7	174.4
65	176.2	174.3	174.5	174.9	173.8	175.9
66	175.4	176.3	175.5	175.1	173.6	175.3
67	175.1	176.3	176.1	175.2	173.4	174.7
68	176.2	175.3	176.9	175.7	173.2	174.7
69	176.2	175.2	176.9	177.1	174.0	174.5
70	176.5	175.2	177.0	175.6	174.3	175.9
71	175.7	175.1	178.4	177.0	174.3	177.0
72	175.1	175.4	178.0	176.3	173.6	176.8
73	175.3	177.8	177.6	177.4	174.4	175.2
74	175.4	177.9	175.9	178.0	175.3	173.9
75	174.6	177.7	176.1	177.4	176.2	175.1
76	174.8	175.7	175.9	177.6	176.2	173.7
77	174.9	175.1	174.7	178.4	175.8	174.2
78	175.2	175.0	176.1	177.1	175.5	173.4
79	176.0	175.0	176.7	177.1	175.2	173.3
80	175.8	175.0	174.5	177.6	175.2	174.0
81	174.2	177.4	176.3	177.2	174.3	173.4
82	175.2	176.5	177.4	176.1	174.5	173.4
83	174.0	178.4	175.5	176.5	174.5	174.5
84	172.8	177.0	176.6	176.1	176.1	173.0
85	174.0	177.8	176.6	175.3	175.1	173.8
86	174.8	176.8	175.5	175.2	175.1	173.9
87	172.8	175.6	176.7	175.2	175.2	173.2
88	172.5	174.8	176.6	175.5	173.3	173.1
89	175.6	174.5	176.6	175.0	173.4	176.5
90	175.6	174.5	176.0	176.1	174.3	172.9

STATIC MAIN BLADE FREQUENCIES IN HZ OF LAST STAGE

L.P. STEAM TURBINE MACHINE B, SET 2

WHEEL						
Blade Number	LP ₁ Steam end	LP ₁ Alternator end	LP ₂ Steam end	LP ₂ Alternator end	LP ₃ Steam end	LP ₃ Alternator end
1	177.0	174.8	176.5	177.6	176.3	176.2
2	177.0	176.2	176.5	173.8	176.5	177.6
3	176.0	175.7	174.4	173.8	174.6	175.4
4	175.9	177.0	172.9	173.8	174.5	175.4
5	175.4	175.4	172.5	173.8	174.2	175.4
6	173.2	174.2	173.8	173.4	172.8	176.1
7	176.9	176.8	174.9	174.5	173.2	176.1
8	174.6	177.9	178.7	174.5	172.6	176.4
9	174.5	177.7	177.6	175.0	172.2	177.2
10	177.5	178.5	177.6	175.0	173.9	175.1
11	178.6	178.4	177.6	175.2	175.6	177.0
12	178.4	177.6	175.9	175.2	175.4	175.2
13	177.6	174.9	173.4	173.7	175.8	175.2
14	177.3	174.8	173.5	173.5	177.1	175.3
15	178.2	175.2	173.2	173.2	178.2	175.2
16	178.0	174.9	174.1	173.3	178.5	174.9
17	176.9	174.8	175.4	174.0	177.3	174.9
18	176.2	175.0	175.6	175.6	177.7	174.9
19	176.9	174.5	175.7	177.6	173.9	175.0
20	176.9	175.0	175.7	177.8	172.7	175.0
21	177.0	174.8	175.7	177.3	172.0	174.2
22	176.1	174.8	176.0	175.5	174.4	175.0
23	176.8	175.6	176.6	174.7	174.8	174.9
24	176.4	175.3	178.2	174.7	175.3	175.2
25	175.8	174.0	177.5	174.6	177.9	175.4
26	175.8	176.1	176.3	177.1	178.5	175.9
27	175.4	175.0	177.2	178.4	178.2	178.1
28	176.0	176.2	177.2	177.5	177.3	175.4
29	176.2	174.1	176.1	177.4	174.5	175.4
30	178.1	176.2	176.7	176.3	173.0	175.4
31	176.3	175.0	178.6	173.8	174.2	176.2
32	174.5	177.0	177.4	174.9	174.8	176.6
33	174.6	177.1	177.4	174.9	175.7	176.7
34	174.9	173.6	174.2	174.9	177.3	176.2
35	177.4	173.9	174.2	176.3	176.5	177.1
36	177.0	173.7	175.5	178.2	176.2	178.1
37	177.3	173.1	176.4	175.5	178.1	178.3
38	177.9	176.2	177.0	176.3	177.6	178.1
39	177.2	177.1	175.0	176.3	176.8	177.6
40	177.3	175.1	172.7	174.7	174.3	176.2
41	176.3	175.2	173.0	173.1	174.1	177.6
42	175.9	175.2	173.2	176.6	173.5	177.0
43	177.4	175.3	173.2	175.2	173.2	175.1
44	175.0	175.1	173.2	174.1	172.6	176.2
45	175.2	173.6	173.5	177.9	172.9	176.3
46	174.7	176.5	173.5	174.2	175.4	176.9
47	174.6	176.3	175.9	174.5	177.3	177.0
48	173.9	174.8	176.0	176.0	178.4	177.8
49	176.1	176.8	175.0	176.2	178.2	177.9
50	175.8	178.5	174.5	175.9	176.4	174.1
51	175.5	177.1	175.8	174.8	175.3	175.2
52	178.7	174.3	175.8	174.8	174.2	173.2
53	177.8	174.1	175.8	174.9	174.8	173.9
54	178.3	176.6	175.8	175.0	176.9	173.7
55	178.1	177.5	175.8	176.3	175.5	174.0
56	176.4	176.0	177.0	176.7	173.2	175.1
57	174.6	173.0	177.2	176.7	172.1	174.2
58	174.7	175.0	177.3	176.9	174.7	178.3
59	176.6	174.9	177.2	177.7	177.3	178.4
60	177.2	174.5	177.2	178.1	178.0	178.0
61	177.1	173.8	177.2	178.0	177.9	177.9
62	177.2	173.6	175.3	177.7	176.2	178.2
63	177.1	173.0	175.2	177.8	176.2	176.1
64	177.1	174.6	174.2	176.9	175.3	176.2
65	178.5	174.5	175.6	176.8	173.4	175.1
66	177.5	174.5	177.1	176.9	173.7	175.6
67	176.5	174.6	173.2	176.1	175.9	175.6
68	177.4	177.1	172.1	176.2	176.4	174.8
69	177.4	176.8	172.0	176.7	176.2	174.7
70	178.2	173.8	178.5	175.3	176.1	175.2
71	178.1	174.0	178.2	175.5	176.0	173.4
72	178.2	176.2	177.1	175.5	175.8	173.5
73	176.3	176.0	175.7	175.1	174.3	176.0
74	178.8	173.4	176.1	174.7	173.7	175.9
75	176.9	173.2	175.8	174.9	176.1	176.2
76	178.1	174.0	175.6	174.6	175.4	176.1
77	176.7	175.0	175.9	175.9	176.2	177.5
78	177.1	174.9	175.4	176.1	178.1	177.8
79	177.1	175.5	175.2	174.8	177.6	178.0
80	177.6	174.8	176.0	177.3	176.2	177.4
81	176.3	174.4	176.4	178.0	176.9	176.2
82	176.3	174.4	177.2	177.5	175.6	176.1
83	176.2	174.2	178.1	174.8	174.3	176.1
84	175.7	174.8	177.2	174.9	175.8	176.5
85	175.8	174.3	175.4	175.3	172.1	176.9
86	175.7	173.5	174.4	175.2	172.5	177.2
87	177.0	174.4	174.4	175.2	174.2	173.4
88	175.4	174.9	173.1	174.6	175.8	174.2
89	176.2	175.7	175.2	176.5	175.7	174.9
90	176.4	175.9	176.1	176.3	176.3	175.6

TABLE 21

STATIC MAIN BLADE FREQUENCIES IN HZ OF LAST STAGE

L.P. STEAM TURBINE MACHINE B, SET 3

Blade Number	WHEEL					
	LP ₁ Steam end	LP ₁ Alternator end	LP ₂ Steam end	LP ₂ Alternator end	LP ₃ Steam end	LP ₃ Alternator end
1	174.6	174.8	175.1	176.1	175.3	171.6
2	174.8	174.8	175.2	176.2	175.3	172.6
3	174.3	174.7	175.1	176.0	175.3	172.6
4	174.6	178.1	176.6	176.9	175.3	172.6
5	176.0	177.1	176.5	176.7	175.3	172.6
6	176.0	176.8	176.4	176.7	175.3	172.2
7	175.3	176.5	176.4	176.2	175.7	171.7
8	175.3	174.8	176.3	176.2	178.1	171.7
9	174.7	174.7	176.3	176.2	177.4	171.7
10	174.8	175.5	176.8	176.1	177.6	171.7
11	174.8	174.4	176.7	176.1	177.6	171.9
12	174.2	174.2	177.6	176.4	177.3	172.4
13	173.8	174.3	177.8	176.5	177.3	172.4
14	173.8	174.1	177.5	176.5	177.3	172.4
15	173.8	175.9	177.2	176.6	177.3	171.4
16	175.3	175.7	176.9	176.6	178.3	171.4
17	175.2	175.7	176.9	177.4	178.2	171.5
18	174.9	176.0	176.4	176.2	178.2	171.4
19	175.2	176.1	176.4	175.7	178.1	171.5
20	175.4	176.0	176.8	175.7	176.6	172.1
21	174.7	175.1	175.9	175.6	176.6	172.1
22	175.3	175.1	175.2	175.6	176.5	176.1
23	175.6	175.8	175.2	175.6	176.5	174.1
24	175.2	175.8	175.2	176.6	176.5	174.1
25	175.1	177.2	175.5	176.6	177.6	172.1
26	175.2	174.4	175.5	177.1	176.4	172.1
27	175.1	174.4	175.5	177.2	176.4	172.1
28	175.3	174.3	175.4	176.8	176.4	173.0
29	175.3	174.1	175.6	176.7	176.3	171.8
30	174.9	174.0	176.5	176.3	177.0	170.7
31	174.8	175.3	176.6	176.4	175.8	170.4
32	174.5	176.6	176.7	176.3	175.8	171.4
33	174.6	176.4	176.3	176.1	174.8	170.7
34	174.6	176.3	176.2	176.6	174.8	170.8
35	174.5	176.2	176.1	176.6	178.2	170.8
36	174.5	175.2	176.6	176.6	177.8	171.4
37	174.4	175.6	176.8	176.4	176.6	173.4
38	174.5	174.5	176.7	177.7	176.2	173.3
39	174.8	177.6	176.7	176.5	176.2	173.3
40	174.8	176.2	176.8	176.4	178.2	173.3
41	174.9	176.2	176.3	175.9	178.2	174.5
42	174.9	176.3	176.2	175.9	178.2	172.7
43	176.0	176.3	176.0	175.8	178.2	172.0
44	176.0	175.4	176.1	176.7	177.5	171.7
45	175.9	175.4	176.2	177.0	177.5	171.7
46	175.3	175.3	176.6	177.2	176.7	171.7
47	174.7	175.3	176.8	177.3	176.7	171.9
48	174.6	175.1	176.1	177.2	176.7	171.5
49	174.0	175.2	176.1	176.7	177.3	171.7
50	173.9	175.2	175.9	176.6	177.3	171.7
51	174.4	177.6	177.0	176.6	177.4	171.6
52	175.8	177.8	177.0	176.4	177.3	172.8
53	175.7	174.4	176.7	176.3	177.3	172.8
54	175.2	174.0	176.5	176.3	178.0	172.7
55	175.1	174.4	176.3	177.1	175.9	172.7
56	176.1	174.4	176.4	177.0	175.8	173.0
57	174.1	175.9	176.4	177.0	175.3	171.6
58	174.1	175.9	177.3	176.5	175.5	171.6
59	174.2	175.9	176.9	177.2	175.5	171.5
60	174.2	175.8	177.6	176.4	175.8	171.5
61	173.9	177.8	177.4	176.2	176.1	171.6
62	173.4	177.9	177.3	176.1	176.3	172.3
63	174.9	174.7	177.6	175.9	177.7	172.2
64	174.8	174.7	176.1	175.8	177.2	172.3
65	174.2	174.7	176.1	176.8	178.0	171.5
66	173.8	174.7	176.0	176.7	177.8	171.5
67	173.8	176.7	175.9	177.5	177.4	171.4
68	175.1	176.7	176.5	177.0	176.9	171.4
69	175.7	176.4	176.7	176.9	176.1	172.3
70	175.7	176.4	176.4	176.9	176.1	172.2
71	174.9	176.4	176.5	177.0	175.6	172.3
72	174.1	175.5	176.5	176.7	175.6	171.6
73	174.2	175.0	176.2	175.0	175.5	171.6
74	174.2	174.5	176.2	175.0	175.6	171.6
75	174.3	174.5	176.2	175.0	176.8	171.7
76	175.3	174.4	176.2	175.1	176.8	174.8
77	175.9	174.5	176.4	176.7	176.7	174.7
78	175.2	174.6	177.1	176.4	176.1	173.5
79	175.1	174.3	177.0	176.1	176.1	173.6
80	174.6	174.3	177.1	176.6	176.9	172.5
81	174.6	174.4	175.8	177.2	178.0	170.4
82	174.6	174.1	174.8	176.8	174.9	169.9
83	174.5	173.5	174.8	176.3	174.0	171.5
84	176.0	173.5	174.8	176.3	174.0	171.9
85	176.1	173.5	175.1	176.2	176.4	171.9
86	175.0	173.4	175.2	176.1	174.1	171.8
87	174.8	177.3	176.6	176.2	174.1	171.1
88	174.4	174.0	178.3	176.0	174.4	171.1
89	175.5	174.0	175.6	176.0	174.5	171.1
90	175.5	174.0	175.8	175.8	176.5	171.8

TABLE 2.1

STATIC MAIN BLADE FREQUENCIES IN HZ OF LAST STAGE

L.P. STEAM TURBINE MACHINE B, SET 4

Blade Number	WHEEL					
	LP ₁ Steam end	LP ₁ Alternator end	LP ₂ Steam end	LP ₂ Alternator end	LP ₃ Steam end	LP ₃ Alternator end
1	176.8	174.2	174.6	174.3	175.2	173.0
2	176.2	171.9	174.7	174.1	175.2	173.1
3	176.3	171.8	174.8	175.5	174.3	173.0
4	175.8	171.9	174.4	175.5	174.2	173.5
5	175.7	171.9	174.4	175.8	174.3	173.0
6	175.6	172.8	174.3	175.7	174.3	173.2
7	175.8	173.4	175.0	175.8	174.6	173.4
8	175.5	171.9	175.2	176.3	175.0	173.0
9	175.4	171.6	175.4	176.1	175.1	173.0
10	175.5	172.3	174.3	175.8	176.0	171.0
11	175.5	173.6	173.4	175.8	175.8	172.0
12	173.9	175.9	173.3	175.8	175.7	172.7
13	173.1	173.1	176.0	174.1	175.7	172.6
14	173.0	172.5	176.0	175.1	173.4	173.1
15	173.1	172.5	174.0	176.3	174.2	174.6
16	173.9	172.5	174.2	175.7	174.2	172.6
17	173.3	172.5	174.3	175.6	174.2	172.5
18	173.4	172.7	174.3	175.4	174.3	172.5
19	173.4	172.7	174.3	175.4	174.3	172.4
20	173.5	173.2	174.5	175.6	174.3	172.4
21	173.7	173.2	173.7	174.8	174.3	172.8
22	173.2	173.2	174.8	174.8	175.9	174.3
23	173.3	173.3	174.8	174.3	176.0	171.7
24	173.2	173.2	174.8	175.1	176.0	171.0
25	173.7	173.7	175.2	175.4	175.8	171.1
26	173.7	173.7	175.6	175.4	175.8	171.1
27	173.9	173.9	176.2	175.3	176.8	171.0
28	174.1	173.6	176.2	175.3	175.9	174.5
29	174.1	173.6	175.0	174.1	173.6	174.4
30	174.2	176.7	175.0	173.2	174.9	173.1
31	174.2	176.1	175.2	175.1	174.9	172.8
32	175.4	176.1	175.1	175.1	174.9	172.8
33	175.4	175.7	175.8	175.4	175.0	173.0
34	175.6	173.9	176.1	176.2	174.9	172.8
35	175.8	173.8	174.7	176.2	175.1	172.9
36	175.0	173.8	174.1	175.5	174.8	173.6
37	174.9	174.0	174.1	175.5	174.7	173.5
38	174.9	174.0	173.4	175.3	174.4	172.3
39	174.9	174.1	175.9	175.5	174.3	172.3
40	175.1	174.2	175.9	175.5	174.4	172.1
41	176.0	174.3	176.0	174.9	174.6	172.1
42	176.0	173.3	176.2	174.9	174.9	172.0
43	176.1	172.1	176.1	174.7	174.3	172.5
44	176.0	172.0	174.7	174.7	174.2	172.4
45	176.3	171.9	174.8	174.7	174.5	172.4
46	175.9	171.7	174.6	174.8	174.7	172.5
47	175.8	171.7	174.6	174.5	174.7	171.2
48	175.8	173.2	174.7	174.5	174.6	171.2
49	175.7	173.3	174.7	175.1	174.6	171.1
50	176.2	173.3	176.2	174.9	174.7	171.0
51	176.8	173.2	173.0	174.9	174.2	171.3
52	175.3	173.2	173.7	174.6	173.8	173.7
53	175.3	173.3	173.6	174.7	174.2	173.6
54	175.3	173.2	175.4	174.7	175.2	173.6
55	175.5	173.2	176.4	174.7	175.3	172.2
56	175.4	173.3	173.3	174.7	175.3	172.2
57	175.7	173.2	173.3	174.8	175.2	172.0
58	175.6	173.2	173.5	174.8	177.0	172.0
59	175.7	175.7	173.8	175.9	177.1	172.1
60	175.7	175.7	176.3	175.9	176.6	174.0
61	177.0	175.9	176.3	175.3	176.5	174.0
62	177.0	173.9	176.0	176.5	176.4	174.1
63	176.1	173.6	175.1	175.2	176.4	174.1
64	176.2	176.7	175.1	175.2	176.6	174.0
65	176.3	176.1	175.0	175.2	177.8	173.7
66	176.3	176.1	174.4	175.2	177.6	173.6
67	176.4	175.7	174.4	175.2	174.7	173.7
68	175.3	175.7	175.4	175.2	175.9	173.5
69	174.9	175.7	177.8	175.2	175.6	173.5
70	174.9	173.8	174.9	174.9	175.5	172.5
71	174.9	174.0	176.3	175.5	175.5	172.6
72	175.2	172.0	173.8	174.8	175.6	172.8
73	175.3	173.0	173.8	174.8	175.7	172.8
74	175.3	173.0	173.8	174.7	175.7	172.6
75	176.6	172.9	175.5	174.7	173.7	172.5
76	176.5	172.0	175.5	174.8	173.8	173.0
77	176.5	172.0	175.5	174.5	174.2	172.9
78	176.4	172.0	175.5	174.5	174.6	173.7
79	176.7	172.0	176.6	174.5	174.5	173.8
80	177.0	173.0	176.6	173.4	174.9	174.5
81	177.0	173.4	176.6	174.6	174.0	174.6
82	177.0	173.4	174.6	174.8	173.9	172.3
83	176.2	173.5	174.6	174.8	175.0	172.8
84	176.2	174.2	174.5	174.7	175.2	172.9
85	175.8	174.2	174.5	174.9	174.9	173.0
86	176.0	174.1	174.9	176.3	174.6	172.6
87	176.0	175.8	174.9	176.4	174.6	172.5
88	176.0	173.2	176.1	176.3	174.3	172.8
89	176.0	173.2	176.1	176.3	175.3	172.9
90	176.6	174.2	174.2	176.8	175.3	172.9
			174.0	176.1	175.1	173.3

TABLE 23STATIC WHEEL VIBRATION FREQUENCIES IN Hz FOR MACHINE B SET I

Mode	STAGE					
	LP1		LP2		LP3	
	Steam end	Alternator end	Steam end	Alternator end	Steam end	Alternator end
0	46.6	46.6	46.5	46.9	46.6	46.7
0	48.3	48.2	47.9	48.2	48.0	48.1
1	61.1	61.4	61.8	62.1	61.9	62.1
2	85.5	86.5	87.3	87.5	87.8	87.1
3	93.5	93.7	94.3	93.7	94.1	93.5
4	95.7	95.6	96.3	96.1	95.9	95.3
5	97.3	97.1	97.9	98.9	97.5	96.7
6	99.3	99.2	99.9	99.6	99.6	99.0
7	101.7	101.8	102.3	103.4	101.9	101.3
8	104.9	104.4	105.3	105.1	105.0	104.3

TABLE 24

STATIC WHEEL VIBRATION FREQUENCIES IN Hz FOR MACHINE B SET II

Mode	STAGE					
	LP1		LP2		LP3	
	Steam end	Alternator end	Steam end	Alternator end	Steam end	Alternator end
0	47.3	47.5	48.1	47.2	45.1	44.6
0	-	-	-	-	46.6	46.9
1	61.4	60.6	60.4	61.8	58.7	57.8
2	87.2	84.0	85.7	87.1	82.6	84.0
3	94.3	92.5	93.6	93.3	91.6	92.6
4	96.0	94.4	95.3	95.6	94.1	95.0
5	97.7	95.7	96.9	97.5	97.4	97.0
6	99.4	98.1	97.8	99.2	99.6	100.0
7	101.9	100.4	99.5	101.6	100.2	101.1
8	104.6	103.2	104.6	104.3	103.0	105.8

TABLE 25STATIC WHEEL VIBRATION FREQUENCIES Hz FOR MACHINE B SET III

Mode	Stage					
	LP1		LP2		LP3	
	Steam end	Alternator end	Steam end	Alternator end	Steam end	Alternator end
0	47.2	47.2	47.8	47.7	46.0	46.1
0	-	-	-	47.7	47.4	47.4
1	62.3	61.6	63.2	63.1	60.3	59.1
2	87.8	85.8	89.5	88.8	85.3	82.4
3	94.8	92.9	95.4	93.8	93.0	91.3
4	96.4	94.5	97.4	95.7	95.0	93.3
5	97.8	96.7	98.9	97.1	97.8	94.3
6	99.8	98.2	100.8	98.9	98.7	96.6
7	102.2	100.2	103.2	101.3	100.8	98.8
8	105.2	106.6	106.3	104.1	103.6	101.6

TABLE 26

STATIC WHEEL VIBRATION FREQUENCIES IN Hz FOR MACHINE B SET IV

Mode	STAGE					
	LP1		LP2		LP3	
	Steam end	Alternator end	Steam end	Alternator end	Steam end	Alternator end
0	46.8	46.9	46.8	46.7	46.4	46.0
0	48.4	48.9	47.9	47.1	48.3	47.4
1	59.6	59.6	59.6	58.5	59.9	58.6
2	83.2	82.8	83.2	86.1	84.3	82.1
3	93.0	91.4	93.7	92.5	92.5	90.8
4	95.2	93.5	95.7	94.9	90.0	92.9
5	96.7	95.0	97.6	96.4	96.4	94.2
6	98.6	97.2	100.8	98.2	98.2	96.3
7	101.1	99.5	101.8	100.4	100.4	98.5
8	103.6	102.3	104.0	103.3	103.4	101.1

TABLE 27

STATIC MAIN BLADE FREQUENCIES IN Hz OF PRODUCTION WHEEL OF LAST STAGE
ON A 120 MW MACHINE TYPE 'B' (RIVETED ROOT)

COMPARISON OF INDIVIDUAL BLADE FREQUENCIES BEFORE AND AFTER SERVICE
RUNNING OF 9 YEARS

BLADE NO.	BEFORE RUNNING	AFTER RUNNING	CHANGE IN FREQUENCY	BLADE NO.	BEFORE RUNNING	AFTER RUNNING	CHANGE IN FREQUENCY
	FREQUENCY c/s				FREQUENCY c/s		
1	206.3	203.6	- 2.7	29	203.2	202.5	- 0.7
2	206.7	204.0	- 2.7	30	203.2	202.3	- 0.9
3	203.6	203.0	- 0.6	31	207.4	202.3	- 5.1
4	206.7	203.6	- 3.1	32	207.0	202.8	- 4.2
5	205.8	203.6	- 2.2	33	207.5	202.9	- 4.6
6	206.6	203.2	- 3.4	34	207.0	202.8	- 4.2
7	206.2	202.6	- 3.6	35	205.4	202.8	- 2.6
8	206.7	202.5	- 4.2	36	206.6	202.0	- 0.2
9	202.2	202.7	+ 0.5	37	202.2	202.0	- 0.2
10	206.0	202.7	- 3.3	38	202.8	202.1	- 0.7
11	204.2	201.9	- 2.3	39	204.9	202.1	- 2.8
12	205.0	202.0	- 3.0	40	203.8	202.7	- 1.1
13	205.2	202.0	- 3.2	41	205.8	202.5	- 3.3
14	205.2	201.2	- 4.0	42	202.6	202.3	- 0.3
15	202.8	200.2	- 0.6	43	202.6	202.3	- 0.3
16	206.6	200.7	- 5.9	44	206.2	202.4	- 3.8
17	202.4	201.8	- 0.6	45	205.6	203.3	- 2.3
18	206.7	200.5	- 6.2	46	206.6	203.2	- 3.4
19	205.2	201.0	- 4.2	47	206.8	203.2	- 3.6
20	203.5	201.0	- 2.5	48	203.2	203.2	- 0
21	206.7	201.0	- 5.7	49	203.2	203.3	+ 0.1
22	205.2	201.0	- 4.2	50	205.8	202.7	- 3.1
23	206.8	201.4	- 5.4	51	208.2	202.6	- 5.6
24	202.5	201.3	- 1.2	52	203.0	202.7	- 0.3
25	206.8	202.1	- 4.7	53	202.8	202.6	- 0.2
26	206.4	204.0	- 2.4	54	206.4	202.6	- 3.8
27	206.5	202.3	- 3.8	55	207.0	203.6	- 3.4
28	203.8	202.3	- 1.5	56	207.0	203.1	- 3.9

STATIC MAIN BLADE FREQUENCIES IN Hz OF PRODUCTION WHEEL OF LAST STAGE

ON A 120 MW MACHINE TYPE 'B' (RIVETED ROOT)

COMPARISON OF INDIVIDUAL BLADE FREQUENCIES BEFORE AND AFTER SERVICE

RUNNING OF 9 YEARS.

BLADE NO.	BEFORE RUNNING	AFTER RUNNING	CHANGE IN FREQUENCY	BLADE NO.	BEFORE RUNNING	AFTER RUNNING	CHANGE IN FREQUENCY
	FREQUENCY c/s				FREQUENCY c/s		
57	203.6	203.2	- 0.4	85	206.7	203.1	- 3.6
58	207.2 [?]	203.1	- 4.1	86	206.1	202.9	- 3.2
59	207.5	203.1	- 4.4	87	203.6	202.9	- 0.7
60	205.3	203.1	- 2.2	88	206.9	202.7	- 4.2
61	203.2	202.7	- 0.5	89	206.7	202.7	- 4.0
62	203.2	202.6	- 0.6	90	205.7	202.8	- 2.9
63	203.2	202.7	- 0.5	91	205.8	202.7	- 3.1
64	206.7	202.9	- 3.8	92	203.6	202.7	- 0.9
65	204.5	203.0	- 1.5	93	202.8	202.7	- 0.1
66	201.7	201.9	+ 0.2	94	202.0	202.7	+ 0.7
67	203.1	202.0	- 1.1	95	202.0	202.7	+ 0.7
68	204.3	202.1	- 2.2	96	NO RESPONSE	203.2	-
69	201.7	201.9	+ 0.2	97	204.3	203.1	- 1.2
70	205.7	201.5	- 4.2	98	206.6	203.1	- 3.5
71	202.3	201.3	- 1.0	99	206.2	203.0	- 3.2
72	205.7	201.6	- 4.1	100	206.5	203.1	- 3.4
73	203.9	202.6	- 1.3	101	202.7	202.9	+ 0.2
74	205.9	202.6	- 3.3	102	206.6	203.9	- 2.7
75	204.8	202.7	- 2.1	103	205.6	203.5	- 2.1
76	206.0	202.7	- 3.3	104	202.1	202.4	+ 0.3
77	206.2	202.7	- 3.5	105	201.8	201.8	± 0
78	206.8	202.6	- 4.2	106	202.2	202.3	+ 0.1
79	206.0	202.9	- 3.1	107	202.2	202.8	+ 0.6
80	206.6	202.9	- 3.7	108	202.1	202.8	+ 0.7
81	204.1	202.9	- 1.2	109	203.2	203.8	+ 0.6
82	205.8	203.0	- 2.8	110	204.7	203.8	- 0.9
83	207.2	202.9	- 4.3				
84	202.5	202.9	- 0.4				

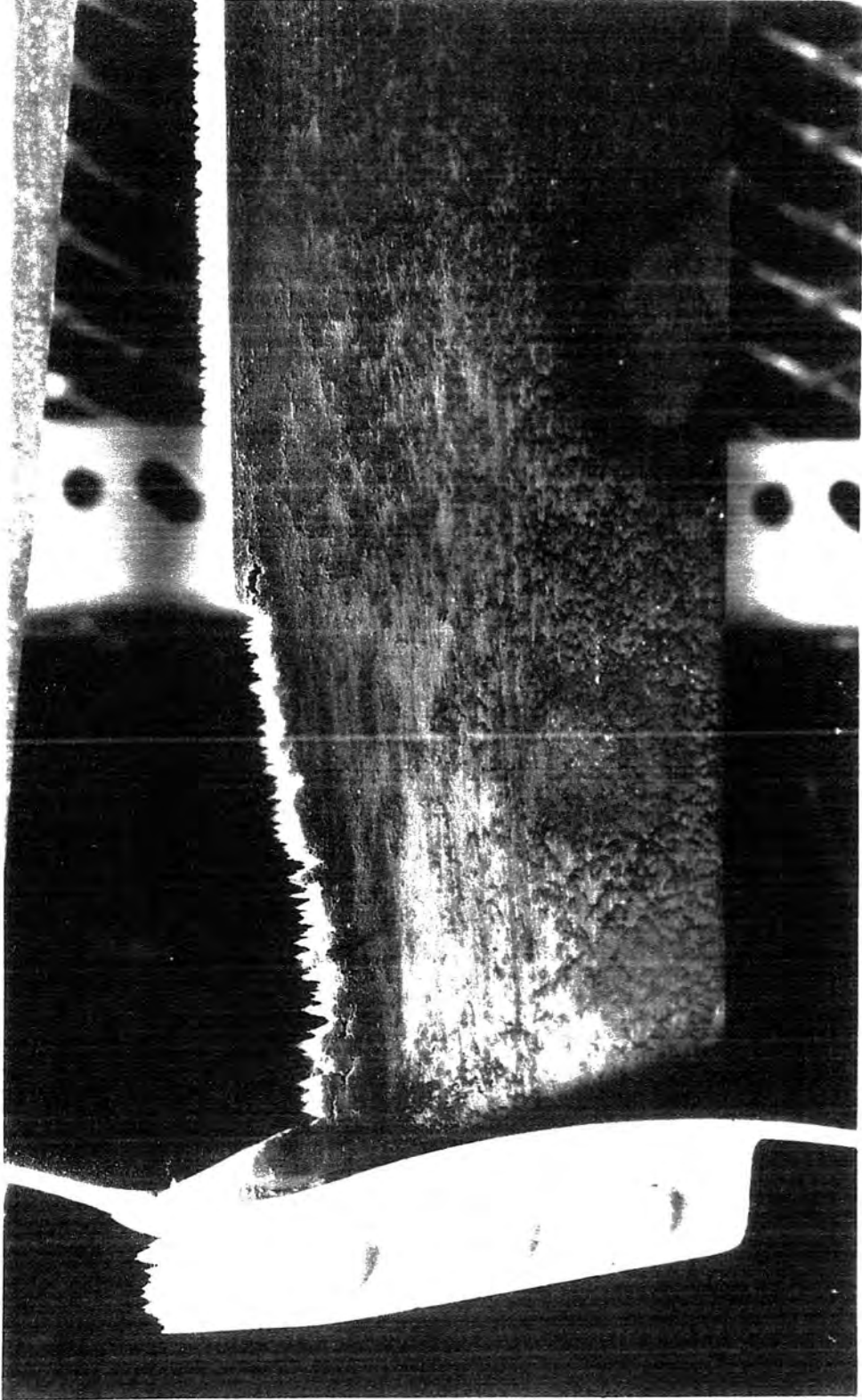

EROSION DAMAGED BLADE

FIG. 42.

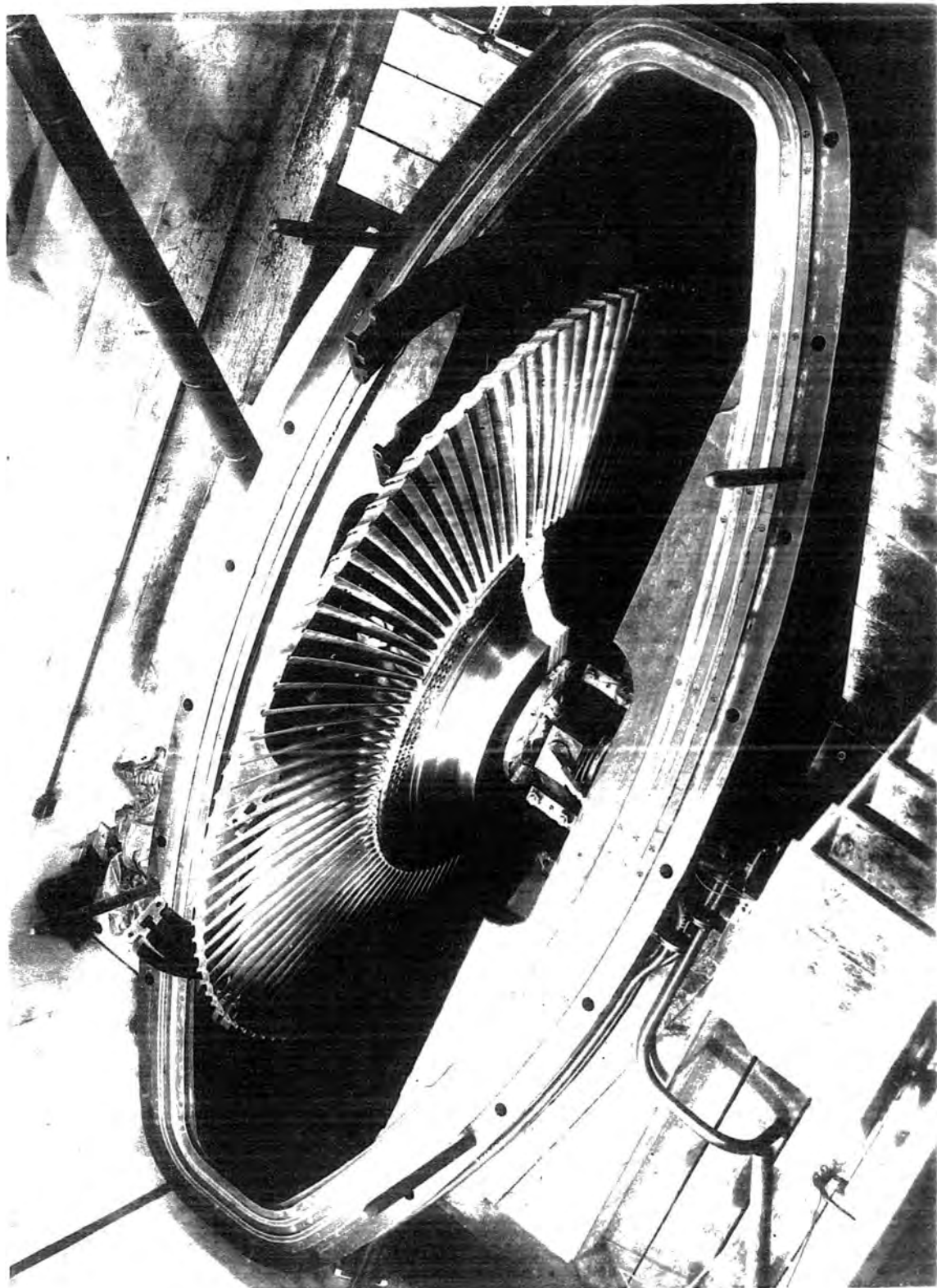

DYNAMIC TEST CHAMBER

FIG. 41.

BIBLIOGRAPHY

- ARMSTRONG, E.K. 1955 - An Investigation into the coupling between turbine disk and blade vibrations. Unpublished Ph.D. Dissertation 2790, Christ's College Cambridge.
- BOTTOMLEY, R.H. and AUGUSTINE, A.F. 1968 - Turbine blade vibration - Automatic charting of static tests. G.E.C. Journal Vol. 35, No. 3 pp 117-120.
- CAMPEBLL, W. 1924 - The protection of steam turbine disc wheels from axial vibration. General Electric Review Vol. 27 Part I, pp 352-360; Part II, pp 359-484; Part III, pp 511-535.
- CAMPEBLL, W. and HACKMAN, W.C. 1925 - Tangential vibrations of steam turbine buckets. Trans. Amerc. Soc. Mech. Engrs. Vol. 47, pp 643-671.
- CARNEGIE, W., DAWSON, B. and THOMAS, J. 1965-66 - Vibration characteristics of cantilever blading. Proceedings of the Institution of Mechanical Engineers, Vol. 180, Part 31, p.71.
- CAVE, L.E., LUCK, G.A. and MITCHELL, J.M. 1963 - Vibration properties of blades. G.E.C. Journal, Vol. 30, No. 1, pp 45-53.
- CAVE, L.E., NORMAN, J.R. and LUCK, G.A. 1964 - Vibration measurement on some stages of a 120 MW Steam Turbine. Tests at Northfleet Power Station. The Engineer, Technical Contributors Section, Sept. 1964 pp 485-490.
- COLLINGHAM, R.H. 1931 - Axial vibration of rotating steam turbine disk wheels. Engineer, Lond. Vol. 151 pp 370-72, 402-404.
- DAWSON, R.A.T. 1966 - Factors to be considered in the design and operation of turbines to prevent failure by thermal fatigue. "Thermal and High Strain Fatigue" - Proceedings of an International conference organised by the Institute of Metals in Association with the Iron and Steel Institute, held in London June, 1967. The Metals and Metallurgy Trust, 1967 (Monograph and Report Serial No. 32).
- DEN HARTOG, J.P. 1965 - Mechanical Vibrations. New York: McGraw-Hill.
- FREUDENREICH, J. von 1925 - Vibration of steam turbine discs. Engineering, Jan. 2, 1925 Vol. CXIX pp 1-8.

- HARRIS, F.R. 1968 - Development of components for large steam turbines. 172
G.E.C. Journal, Vol. 35, No pp 107-116.
- HOCKLEY, B.S. and BUTTERS, J.N. 1970 - Holography as a routine method of vibration analysis.
Journal of Mechanical Engineering Science. Vol. 12, No 1 pp 37-47.
- HOCKLEY, B.S. and HILLS, R.J. 1969 - Vibration and strain analysis by means of holography. 9th Int. Aero. Congress, Paris.
- JEFFCOTT, H.H. 1918 - The periods of lateral vibration of loaded shafts - The rotational derivation of Dunkerley's empirical rule for determining whirling speeds.
Proc. Roy. Soc. (A) Vol. 95, 106.
- JONES, D.H. 1963 - Multi-channel contactless telemetering system for vibration studies on steam turbine blades.
International Telemetering Conference. Sept. 1963.
- KOENIG, M. 1926 - The transverse vibration of steam turbine discs. Rugby Engineering Society, Proceedings 1926-27. Vol. XXI.
- KRASSICK, W.M. 1968 - The development of a miniature High Speed Telemetry system for dynamic stress analysis. Journal of Engineering for Power, Trans. of the ASME January 1968, pp 55-64.
- LUCK, G.A. 1962 - Blade Vibration measurements on rotating turbine wheels. G.E.C. Journal, Vol. 29, No. 2, pp.86-91.
- LUCK, G.A. 1966 - Vibrations of Turbine Blades. Encyclopaedic Dictionary of Physics. Supplementary Volume 1, page 1.
- MALKIN, I. 1942 - On a generalisation of Kirchoff's theory of Transversal Plate Vibrations in the vibration problems of steam turbine disks.
J. Franklin Inst. Vol. 234, pp 355-369, 431-452.
- MITCHELL, J.M. 1969 - Trends in the design of highly rated steam turbines. Parsons Journal, Summer 1969, Vol. 12 No. 68, pp 4-11. (Paper presented to the Institution of Mechanical Engineers, April 1969).
- POCHOBRADSKY, B., JOLLEY, L.B.W. and THOMPSON, J.S. 1931 - The experimental investigation of vibrations in turbine wheels and blades. Engineering, London: Vol. 132, pp 541-545.

- PROHL, M.A. 1945 - A general method for calculating critical speeds of flexible rotors. Journal of Applied Mechanics. Sept. 1945. Vol. 12 pp. A142-A148.
- PROHL, M.A. 1958 - A method for calculating vibration frequency and stress of a banded group of turbine buckets. Trans. of ASME, Jan. 1958 pp 169-180.
- RAO, J.S. and CARNEGIE, W. 1971 - Determination of the frequencies of lateral vibrations of tapered cantilever beams by use of the Ritz-Galerkin process. Bulletin of Mechanical Engineering Education. Vol. 10 Number 3, Aug. 1971 pp. 239-245.
- REEMAN J. and LUCK, G.A. 1951 - Turbine Blade and Wheel Vibration. G.E.C. Journal Vol. 18, No. 4 pp 179-193.
- RIPPERGER, E.A. 1952 - A technique for elastic wave measurements. Stanford University Technical Report No. 12.
- RISSONE, R.F. and WILLIAMS, J.J. 1965 - Vibration of non-uniform cantilever beams. The Engineer, September 1965.
- SCOTT, D. and SCOTT, H.M. 1957 - The electron microscope in the study of wear. Proceedings of the Institution of Mechanical Engineers. pp. 609-612.
- SMITH, D.M. 1933 - The motion of a rotor carried by flexible bearings. Proc. R. Soc.(A). 142. 92(1933).
- WOZNEY, G.P. 1962 - Resonant Vibration Fatigue Testing. Experimental Mechanics. January 1962 pp 1-8.

