



Durham E-Theses

Linear control of machine tools using fluidic devices

Routledge, Edward G.

How to cite:

Routledge, Edward G. (1971) *Linear control of machine tools using fluidic devices*, Durham theses, Durham University. Available at Durham E-Theses Online: <http://etheses.dur.ac.uk/10251/>

Use policy

The full-text may be used and/or reproduced, and given to third parties in any format or medium, without prior permission or charge, for personal research or study, educational, or not-for-profit purposes provided that:

- a full bibliographic reference is made to the original source
- a [link](#) is made to the metadata record in Durham E-Theses
- the full-text is not changed in any way

The full-text must not be sold in any format or medium without the formal permission of the copyright holders.

Please consult the [full Durham E-Theses policy](#) for further details.

LINEAR CONTROL OF MACHINE TOOLS

USING

FLUIDIC DEVICES

THESIS SUBMITTED FOR THE DEGREE OF MASTER OF SCIENCE

IN THE

UNIVERSITY OF DURHAM

EDWARD G. ROUTLEDGE

C.Eng., M.I.Mech.E., M.I.Prod.E., M.I. Plant.E.

January, 1971.

ABSTRACT OF THESIS

Linear Control of Machine Tools using Fluidic Devices

Submitted by:

E. G. Routledge. C.Eng., M.I.Mech.E., M.I.Prod.E., M.I. Plant.E.

This thesis is concerned with the development and manufacture of a fluidic variable event control system for turret lathes, which can be programmed to give any desired tool-slide length of travel in increments of 0.001 inch.

The system consists of pneumatic-hydraulic machine actuating cylinders, fitted with sensors to provide machine information, and a control cabinet containing the Logic, Counter, Address and Programme Systems. Fluidic devices are used throughout, providing data signals, performing the Logic function, and issuing command signals to the Address System.

Control of events, such as the engagement of the cross-slide, change of feed etc., have been related to the ram-slide motion; fluid displaced from the ram-slide actuating cylinder is metered into either a storage tank or slave cylinders in the control cabinet, which, repeat and amplify the motion. Sensing units fitted to the slave cylinders, are programmed to inform the Logic System when the machine slide has travelled the required distance for an event, which initiates command signals to the address system.

Programming a selection of events, their sequence and distance to be travelled by a tooling arrangement is achieved by using multi-channel selector units. Each unit has six programme channels and controls an event, such as the rate of feed for each turret face. On receipt of a start signal, programme channel number 1 of each selector unit is energised, turret face number 1 is presented to the component material and the events programmed take place. When the sequence of operations for that turret face have been completed, the slides return to their starting point. Indexing of the turret to present face number 2 energises programme channel number 2 to control events for this face. This process is repeated until turret face number 6 and programme channel number 6 has been used; the component has now been completed and the cycle is repeated.

The programme is not pre-determined such as when using plug-board, punched card or tape, and can be varied by shop floor

personnel adjusting the programme selector units while the machine is in operation. This feature not only enables component lengths to be adjusted, but as the choice of such events as speed, feed, or when to start the cross-slide may be varied to suit the actual working conditions, optimum production performance is more readily achieved.

ACKNOWLEDGMENTS

The Author wishes to thank Professor R. Hoyle for his approval of the project. It is pleasing to acknowledge the valuable assistance of Dr. E. C. Salthouse who, in addition to supervising this work, has given encouragement, constructive criticism and time freely.

The Author is grateful to the Darlington Education Authority, Chairman and Members of the Governing Body of Darlington College of Technology, and his Principal, Mr. C. E. Beyon for their permission and the facilities made available to undertake this project. He is also appreciative of the assistance and co-operation of Dr. H. Williams and the counsel of Mr. F. Horsfield, Mr. D. Bailey, Mr. C. Hodgson and others.

CONTENTS

<u>Chapter</u>		<u>Page</u>
I.	Introduction.	1
II.	Sequence Control Systems.	4
2.1.	Review of present equipment.	4
2.2.	Electronic sequence control systems.	5
1.	Description of design features.	5
2.	Description of mechanical features.	7
2.3.	Fluidic sequence control systems.	8
1.	Fixed event fluidic systems.	9
2.	Variable event fluidic systems.	13
2.4.	Conclusions on sequence control systems.	13
2.5.	General requirements of a Linear Programmed variable event system.	16
1.	Fluidic sensing units for linear control.	16
2.	Selection of a sensing orifice.	18
3.	Reductions in the number of pipes to the machine tool.	19
4.	Reduction in the number of sensing unit signal pipes.	19
5.	Operation sequence.	19
6.	Control of turret slide.	20
7.	Programming.	20
III.	General features of design.	22
3.1.	Turret slide motion.	22
3.2.	Cross-slide motion.	26
3.3.	Control of turret slide length and related operations.	26
3.4.	Programme selection unit.	27
3.5.	Logic system.	27
3.6.	Address system.	28
3.7.	General description.	28
IV.	Fluidic, pneumatic and hydraulic circuits.	30
4.1.	Circuit structure.	30
4.2.	Circuit details.	31

	1.	Channel selection fluidic circuit.	31
	2.	Cross-slide fluidic circuit.	33
	3.	Feed selection fluidic circuit.	33
	4.	Selector switchboard fluidic circuit.	35
	5.	Speed and collet fluidic circuit.	35
	6.	Valve control fluidic circuit.	39
	7.	Cross-slide pneumatic-hydraulic circuit.	41
	8.	Turret slide pneumatic-hydraulic circuit.	41
	9.	Schematic arrangement of fluidic, pneumatic and hydraulic circuits.	44
V.		Design and construction.	46
	5.1.	Machine tool operation.	46
		1. Speed selection.	46
		2. Collet operation.	46
		3. Turret slide motion.	47
		4. Cross-slide motion.	47
	5.2.	Control cabinet.	47
	5.3.	Machine tool power cylinders.	48
		1. Turret slide power cylinder unit.	48
		2. Cross-slide power cylinder unit.	48
		3. Power signal pipes to the machine tool.	50
	5.4.	Description and manufacture of Control Cabinet Units.	50
		1. 3 inch diameter slave cylinder unit.	50
		2. 0.5 inch diameter slave cylinder unit.	51
		3. Multi-channel Rotary programme unit.	53
		4. Integrated circuit board for the Rotary Programme Unit.	69
		5. Junction and Cross-slide manifolds.	62
	5.4.	6. Back pressure signal manifold.	64
		7. Channel supply manifold.	64
		8. Fluidic unit supply manifold.	66
		9. Fluidic unit mounting board.	66
		10. Hydraulic fluid storage tank.	66
		11. Control cabinet frame and panels.	69
	5.5.	Assembly of the Control Cabinet.	69
		1. Assembly of pneumatic-hydraulic equipment.	69
		2. Assembly of Top instrument panel.	75
		3. Fluidic unit boards.	75
		4. Assembly of Instrument panel and fluidic boards in the control cabinet.	78

VI.	Commissioning.	82
6.1.	Performance of Cylinders and Sensing Units.	82
1.	Preliminary Cylinder tests.	82
2.	Preliminary Test Performance.	83
3.	Preliminary Cylinder test conclusions.	84
6.1.	4. Installed Cylinder tests.	84
5.	Installed Cylinder test results.	84
6.	Installed Cylinder test conclusion.	86
6.2.	Performance of the Programme system.	86
1.	Rotary Programme Unit test.	87
2.	Rotary Programme Unit performance.	87
3.	Signal pressure drop.	87
4.	Modifications to the Rotary Programme Unit.	89
5.	Tape Programme Unit.	89
6.	Performance of the Tape Programme Unit.	93
7.	Alterations to the Back Pressure signal arrangement.	98
6.3.	Performance of the Address System.	99
1.	Valve response.	99
6.4.	Performance of the Logic System.	99
1.	Modifications to the Fluid logic air supply.	101
2.	Logic device malfunction.	101
3.	Modifications to the Fluidic circuits.	102
4.	Completion of assembly.	108
VII.	Conclusions.	114
7.1.	Manufactured components.	114
7.2.	Programming.	114
7.3.	Hydraulic amplification of Linear Motion	115
7.4.	Performance of the fluid logic devices	116
7.5.	Construction of the circuits.	116
7.6.	Air Supply.	116
7.7.	Performance of the Control System	117
7.8.	Fault finding.	117
7.9.	Performance of Fluidic Systems.	118
7.10.	Modifications to improve performance.	118
7.11.	Future additions to the Control System.	119
1.	Coolant supply.	119
2.	Woodpecker turret slide feed.	119
3.	Tapping operation.	120
4.	Cross-slide front toolpost indexing.	120
5.	Interlocking complimentary systems.	120
7.12	Cost	120

List of References	122
Appendix I.	124
Fluidic terminology.	124
Fluid logic component symbols.	127
Fluid logic component application data.	128
Appendix II.	129
Pneumatic and Hydraulic Equipment.	129
Circuit Symbols.	131
Valve flow charts.	132

CHAPTER I

Introduction

This thesis is based on an investigation into the feasibility of fluid logic devices in the low cost automation of machine tools, such as capstan lathes utilised for small batch quantity production.

The most common method to date consists of an electronic sequence control unit, which incorporates a programmer, sensing and actuating systems. The sensing system, usually micro-switches, signal the control cabinet when an operation or motion has been completed. When combined with signals from the programmer, the actuating system, usually electro-pneumatic or electro-hydraulic, perform the series of events incorporated in the programme. These systems, are in effect attachments to fit a manually operated machine and cost between £1,000 to £2,000. When programmed for a component, control the sequence of operations, select feeds, speeds, traverses and eliminate the human element. The result is improved uniformity in component size; an increase in output varying between 15% to 35% depending upon the component, and a reduction in direct labour cost, as one operator can now supervise several machines.

Preparing the converted machine tool for the production of a component is similar to one manually operated; tools and length stops must be changed or re-positioned, and the programme, usually prepared in the Planning Office, inserted. Control of the machine tool is now divided between the Shop Floor and Planning Office; departmental communications must be efficient as a programme could be made obsolete due to an unforeseeable problem. Such an occurrence may arise if the machine-ability of material for the initial batch differs from expectation; the machine would be idle until a revised programme, based on actual machining experience of the material, is prepared.

In the block diagram of a typical sequence control unit on Page 6 Chapter II, it can be seen that control signals and logic functions use electrical energy; this must be converted before the valves controlling the pneumatic-hydraulic circuits can be actuated. Conventional pneumatic equipment could be used to eliminate

conversion, but the physical dimensions of components make it impracticable. An alternative to conventional pneumatics would be the use of a low pressure air supply for control signals and logic functions; the low pressure output command signals would actuate high pressure circuits.

Based on the fundamental work of L. Prandth and H. Coanda, the concept of fluid amplification was discovered by B. M. Norton, R. E. Bowles, R. W. Warren and others at the Harry Diamond Laboratories in 1958. By 1960 the potential of this new technology became apparent; research and development of fluidic amplifiers was intensified, so that by 1966 a range of digital and analogue devices were available. Simultaneously, methods of programming were being developed; by 1967 punched card, tape readers and drum programmers were available for use in pneumatic sequence control systems. It was against this background that the project commenced in October 1967. In addition to pneumatic sequence control and logic, it would give linear control of tool-slide traverses, eliminating the use of length stops and have a programming system which could be prepared or modified by Shop Floor personnel. This thesis records the progress since October 1967; the selection of standard components, design and manufacture of special units, assembly and testing.

The background work involved a study of available low cost automation sequence control systems, fluid logic devices, pneumatic and hydraulic equipment which are discussed in Chapter II and their salient points noted. An outline of the proposed system is included in Chapter III; the problems and techniques envisaged to meet the specification are considered, and a block diagram constructed, illustrating the relationship of individual components. The circuit design described in Chapter IV, shows how the individual requirements of each control, fluidic function or pneumatic-hydraulic circuit is made, and also their relationship to each other. In Chapter V, the design, manufacturing technique, construction of sensing devices, programme selector unit, circuit boards and other miscellaneous items are given. When preliminary tests have indicated a potential improvement in performance, modifications to the design have been made. The tuning of signals to or from fluidic devices, sensors and valves; the testing of logic circuits; repeatability of actuating cylinders, and problems associated with persuading the system to function are recorded in Chapter VI. In Chapter VII, modifications to the design have been suggested which may improve performance, extend the

operational capacity and improve reliability.

CHAPTER II

Sequence Control Systems

Where a logic circuit controls a series of events in an orderly pre-determined manner, each event taking place after the completion of a proceeding event, which provides a command signal, it is referred to as a sequence control circuit. Only a limited control is exercised over the machine during an operation, and the circuits may be either fixed or variable event systems. The fixed event system provides a repetitive operation cycle that cannot be changed; the variable event system can be programmed to provide any order of events.

2.1. Review of Present Equipment

One of the first exercises undertaken in this project, was to examine currently available low cost automation sequence control equipment and the type of situation in which they are used. Literature describing the equipment was obtained from manufacturers, and, where ever possible, various systems were observed in operation.

The commercial systems available, were electronically operated variable sequence control systems, which converted manually operated turret lathes into automatic lathes. They consist of three basic elements; an electronic control unit; a sensing system, and an actuating system which replaces the muscular effort, and logic control normally supplied by the operator. The designs vary in such details as method of programming, type of sensors and the range of operation features; their cost ranges from £1,000 to £2,000.

No equivalent fluidic system was commercially available: those in operation had been designed for a particular production set-up, had a fixed event programme, comparatively simple in design and relatively cheap. Complex fluidic systems which utilise tape or drum programmers, have been developed and are undergoing tests in research centres at Cranfield and Birmingham; the cost of such systems is not available. The systems reviewed were divided into the following:-

1. Electronic - plugboard programming

2. Electronic - switch programming
3. Fluidic - fixed sequence
4. Fluidic - variable sequence

2.2. Electronic Sequence Control Systems

Figure 1., a block diagram of an electronic sequence control system, illustrated the relationship between the control unit, sensing, and actuating systems. In this simple example, the sensing system consists of two pairs of limit switches, and the actuating system, two solenoid operated pneumatic cylinders. On receipt of a start signal, the control unit initiates a command signal and cylinder C1, moves the turret towards the component. When limit switch S2 is activated on completion of the operation, a data signal is fed into the control unit, and cylinder C1 is reversed. On its return, limit switch S1 provides a data signal to the control unit. The programmed control unit now issues a command signal to the solenoid controlling cylinder C2, and the cross-slide is traversed to perform an operation. At the end of the cross-slide motion, limit switch S3 is activated; the data signal produced informs the control unit that the operation is complete, and a command signal reverses cylinder C2. On its return, limit switch S4 informs the control unit, and a command signal is initiated to repeat the cycle of sequences ad lib. Additional events, such as collet operation, speed change, and the feeding of components, will give an automatic production cycle.

The systems reviewed deviated principally in programming techniques; plugboard systems where a punched card or pegboard controlled the sequences, were manufactured by the following companies:-

1. Elliot Bros. (London) Ltd.
2. Ether Ltd.
3. Ian Nickols Automatics Ltd.
4. Gearside Ltd.

and switch or dial programming systems by:-

5. The Hepworth Iron Co. (Engineering) Ltd.
6. G.K.N. Machinery Ltd.

2.2.1. Description of Design Features

The dust proof control cabinet contains a transistorised logic unit and power pack; the front panel; all the control switches;

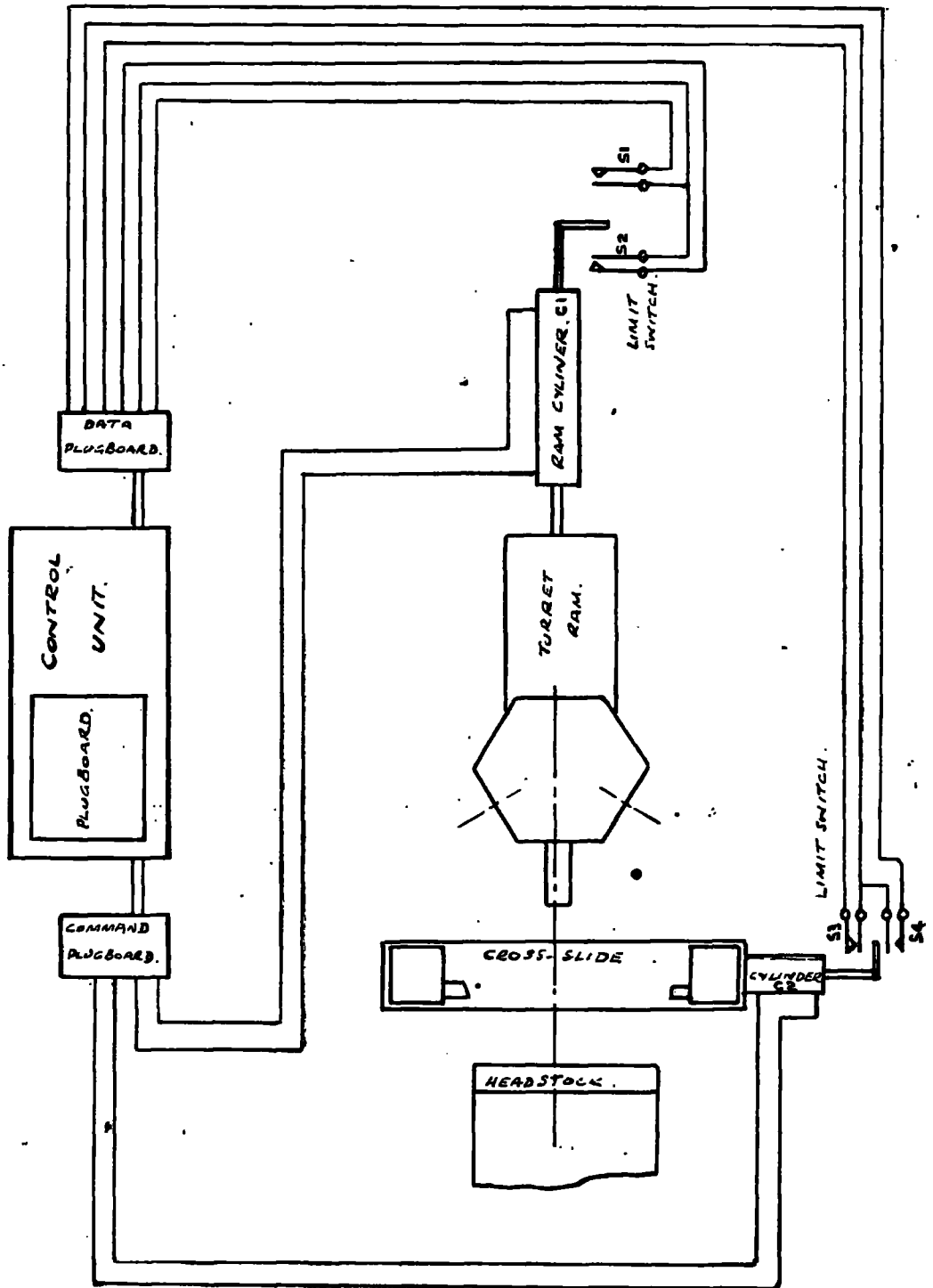

ELECTRONIC SEQUENCE CONTROL SYSTEM. FIG. 1.

the plugboard or punched card reader or programme switches; data and command sockets; a counter to register the number of cycles completed; a bank of lights to indicate which programme is in operation, and individual push button manual controls to facilitate setting of sensing devices and the length or speed of the actuators. An auxiliary programme box, may also be provided to control operations not required in every cycle, for example, re-charging the machine with raw materials. Most systems incorporated build in safety devices and in the more expensive, a monitoring system to locate faults.

Preparation of programmes for systems 1. 2. 3. and 4. required the completion of a chart listing the sequence of operations. From this, a plugboard is prepared by inserting pairs of sockets into numbered holes. These boards can be retained as a permanent record of a particular programme, and stored for future use. When the board is fitted to the control cabinet, electrical connections are made by inserting pins through the sockets into the permanently wired sockets in the control cabinet. An alternative method is a punched card prepared from the sequence chart; the card is placed on the control cabinet and pins inserted through the punched holes into the wired sockets. Programming systems 5 and 6 are usually performed by the machine setter; each turret face has a row of switches for the various events. To modify a programme, the appropriate switch is adjusted, where as the previous systems would have required a new board or card.

Micro-switches are used to provide data signals, but photo-electric cells or any other device can be used, providing they deliver a suitable signal to the control cabinet. The distance travelled by the tool slides, is controlled by adjusting the length stop screws which contact length sensors.

The most common type of actuating system is pneumatic-hydraulic controlled by solenoid operated valves, pneumatics to move the slide forward; hydraulics to control the rate of travel and prevent surge. This arrangement of power usage involved connecting the machine into both air and electrical services. The full hydraulic system selected by one manufacturer, involved only the electrical service, but, as a free standing hydraulic unit is necessary, initial capital outlay is increased.

2.2.2. Description of Mechanical Features

Tools and length stops are set in the same way as a manually operated machine, in addition to this, fifteen to thirty minutes are

required for control cabinet programming, setting the trips to determine the position of feed engagement for each turret face, and cross-slide tool post.

The turret actuator moves the machine slide towards the component at a controlled rate, which is determined by the setting of flow regulators in the circuit, thus giving a selection of three or four rates of feed. Independent controls are provided for each turret station, to determine when the rapid approach traverse changes to controlled feed. The turret is clamped to the machine slide with a locking cylinder when the feed is engaged and indexing is synchronised with the programme. A turret relieving feed or "Woodpecker" action for deep hole drilling may be incorporated in the actuator. In addition, a dwell period at the end of each turret traverse allows tools to open, speed changes to operate and the spindle to stop revolving, before the tools are withdrawn. Interlocked with the turret indexing is a coolant distributor to provide the option of an individual supply to each workface of the turret.

The cross-slide actuator is also fitted with flow regulators to give a rapid approach of the tool, and a range of feeds for both front and rear tool posts. This slide may be programmed to operate independently of the turret slide or to overlap its motion.

Automatic operation of the bar feed mechanism in conjunction with turret slide traverse, collet opening and closing; is synchronised with the spindle speed selection.

Manufacturers provide comprehensive information for machine operation, programming maintenance instructions, and an exhaustive fault-finding section in their manuals. Educational kits are available for some systems, enabling the rapid teaching of control and programme requirements to personnel.

2.3. Fluidic Sequence Control Systems

Fluid logic is a new technology when compared with electronics, the functions and applications are analogous in many respects, but if it is to be successful, must offer some advantage over electronics. The simplicity and effectiveness of fluidic sensing devices is typical of this and as a result, the first machine control applications chosen, used this fact to break into the electronically controlled market. The field of application chosen was in low cost automation using pneumatics, and were fixed event systems which are relatively simple circuits to construct.

When fluidic devices are correctly designed in the right material, they are immune to extremes of temperature, illumination, vibration, corrosion, radiation, mechanical and electrical shocks. Pneumatic and hydraulic systems are in common use, and with the introduction of low pressure actuated valves, fluidic control systems have removed many interface problems, especially power supply. The air used in fluid logic circuits must be oil free, clean and dry to operate satisfactorily or the airways may be effected and the system will malfunction.

Devices are capable of switching within one milli-second, but delays due to the number of devices in a circuit, length of input and output signal pipes, may increase this to one hundred milli-seconds. The type of application is therefore restricted by response time to simple circuits of moderate speed requirements, or more complex circuits with low speed requirements. This restricts the range of application to process control, material handling, marine and some aerospace systems.

The advantages of using fluidic circuits are the simplicity of devices which are virtually indestructable they cannot be destroyed by wrong connections, low cost, and little maintenance due to the high reliability of a circuit once it has been proved. In general, the only servicing is the regular cleaning of air filters, and that the average maintenance engineer finds fluidic rather than electronic circuits easier to understand.

The disadvantages are the resistance to air flow in small bore piping, as this limits the distance a sensing device may be from the logic circuit and the capacitance effect of the tube volume when using pulse signals. The continual consumption of air as devices, exhaust to atmosphere when not fulfilling a function, can be a heavy drain on the supply and the noise of venting devices can be irritating. There is also the possible blockage of air vents by foreign matter, and if devices are closely positioned, the exhaust of one, may effect the function of its neighbour.

2.3.1. Fixed Event Fluidic Systems

A fixed event fluidic system generally uses a back pressure signal from a sensing device to start an operation. Interlocking logic prevents the operation occurring if any proceeding function has not been performed. Figure 2, a block diagram, illustrates such a circuit used to control the filling of containers. The circuit requirements are:

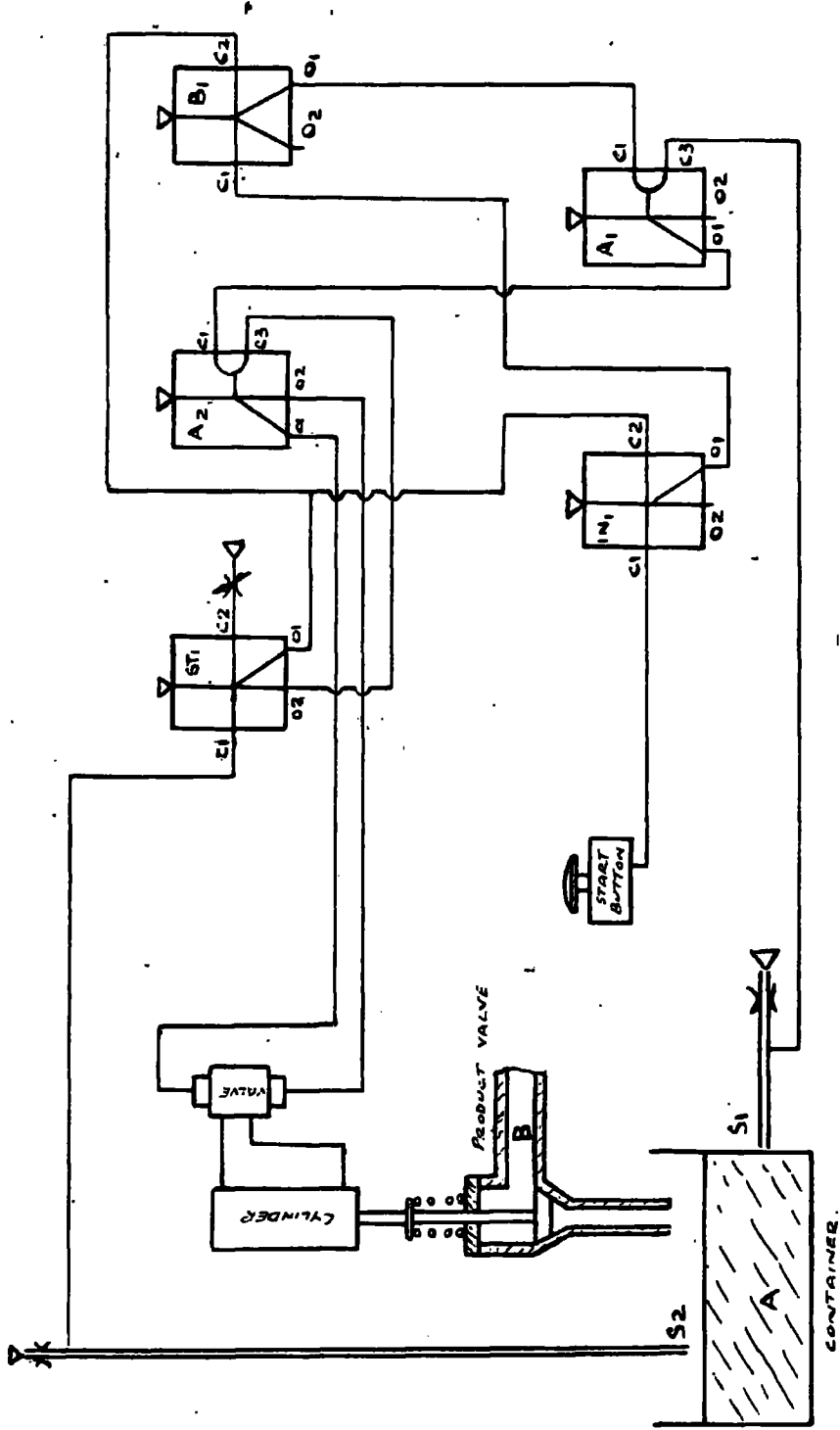

FIG. 2.

FIXED EVENT FLUIDIC SYSTEM.

1. One cycle of functions per start signal
2. A container must be at position "A" under the filler, before valve "B" will operate
3. Filling must continue after removal of the start signal
4. Movement of the container before it is full will stop the flow through valve "B"
5. When the container is full, flow through valve "B" must stop even though the start signal is still present
6. Suitability for conversion to continuous operation at some future date
7. Failure in the pneumatic supply to stop the filling operation

The circuit consists of, one Inhibited OR gate, one Bistable Flip-Flop, two AND gates, one Schmitt Trigger, one Back Pressure Switch, two Sensing Devices, one start button, one 5-Way Diaphragm operated valve, one Double Acting cylinder and a 3-port toggle operated valve for continuous cycling.

When the container to be filled is in position "A", sensor S1 signals And gate A1 at the control port C3. Pressing the start button provides signal C1 at the Inhibited OR gate IN1. to give an output at O1, which is connected to C1 of the Bistable device B1, and the output is switched to O1. And gate A1 now receives its second control at C1 and the output is switched to O1 to provide signal C1 at And gate A2. As the container is empty, sensing device S2 is not providing a signal to C1 of the Schmitt Trigger ST1, and the bias signal at C2, holds the output at O2, which is connected to C3 of And gate A2. Both control signals, C1 and C3 are now present at A1; the output switches to O1, the diaphragm valve is actuated, and the cylinder opens filling valve "B" allowing the product to fill the container. When the product in the container reaches the correct level, sensor S2 provides a signal to C1 of ST1 over-riding bias signal C2. Output is switched to O1 and signal C2 at IN1 over-rides the start button signal if it is still present; output reverts to O2 removing signal C1 from B1. Simultaneously as output O1 of ST1 provides signal C2 to B1, output is switched to O2, removing signal C1 from A1, The O1 output to C1 of A2 to give O2 output, which reverses the diaphragm valve and cylinder to close filling valve "B". A continuous cycle is achieved by providing a constant signal to C1 of IN1, Sensors S1 and S2 now control the cycle which can, quite easily,

VARIABLE EVENT FLUIDIC SYSTEM.

FIG. 3

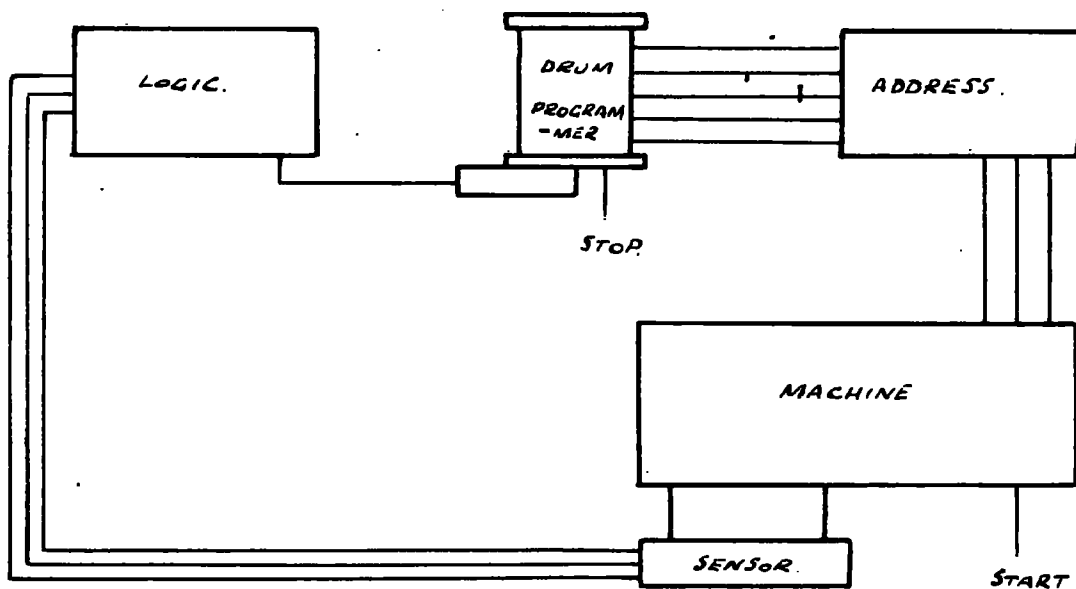

DRUM PROGRAMME PUNCHED TAPE

FIG. 4.

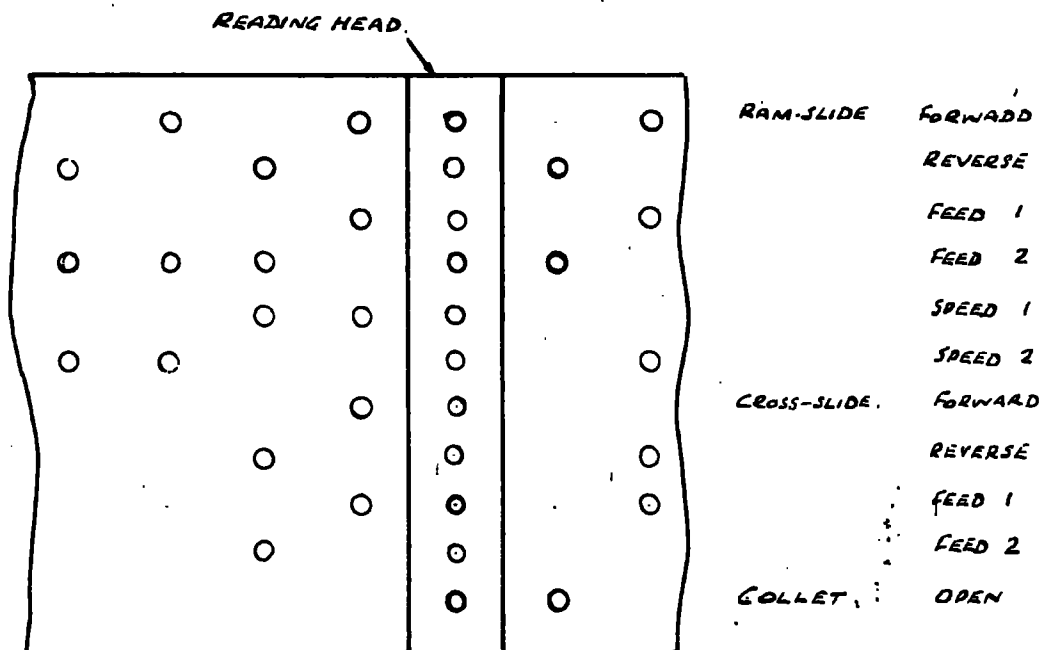

be interlocked with the automatic supply of containers to and from Position A.

2.3.2. Variable Event Fluidic Systems

A variable event fluidic sequence system is analogous with the electronic system described in Chapter 2.2. The cyclic pattern of the turret lathe operation facilitates the use of a drum or disc programmer, geared to make one revolution for each work cycle. The block diagram, Figure 3, illustrates a simple system incorporating a twenty output signal drum programmer, manufactured by Teche Ltd., which is capable of forty sequences. Each output channel is allocated a function, such as direction of ram travel, speed, rate of feed or collet operation, as shown in Figure 4. A sequence of signals is prepared showing which function is required in each row, and holes are punched in the programme sheet before it is fitted to the drum. On receipt of a start signal the drum is indexed, presenting a row of holes to the reading head. The output signal pipes may be connected to fluidic devices or address system valves to give the desired operation of the machine. As each cycle is completed, sensing devices on the machine provide signals to the fluidic sequence interlock system, indicating that all functions have been performed. A feedback signal then indexes the drum, presenting the next row of holes to the reading head for the next cycle.

A more versatile system is illustrated in the block diagram Figure 5; it has the advantage that individual variable instructions may be included within the control loops. Signals from the machine sensing devices are fed into a fluidic interlock system and the output is used as the input to a ring or binary counter circuit. When the correct count appears, it is decoded by the Address logic circuit, which distributes the information to the correct function, and the appropriate operations are performed. In order to associate the counter output with an order of events, a matrix arrangement, usually a plugboard or card reader, is interposed between the Counter and Address circuits. Alternatively, a tape controlled unit may be utilised, which will also act as a mechanical ring counter.

2.4. Conclusions on Sequence Control Systems

It is evident from the review of existing equipment, that the application of fluidics in machine tool control systems is in an

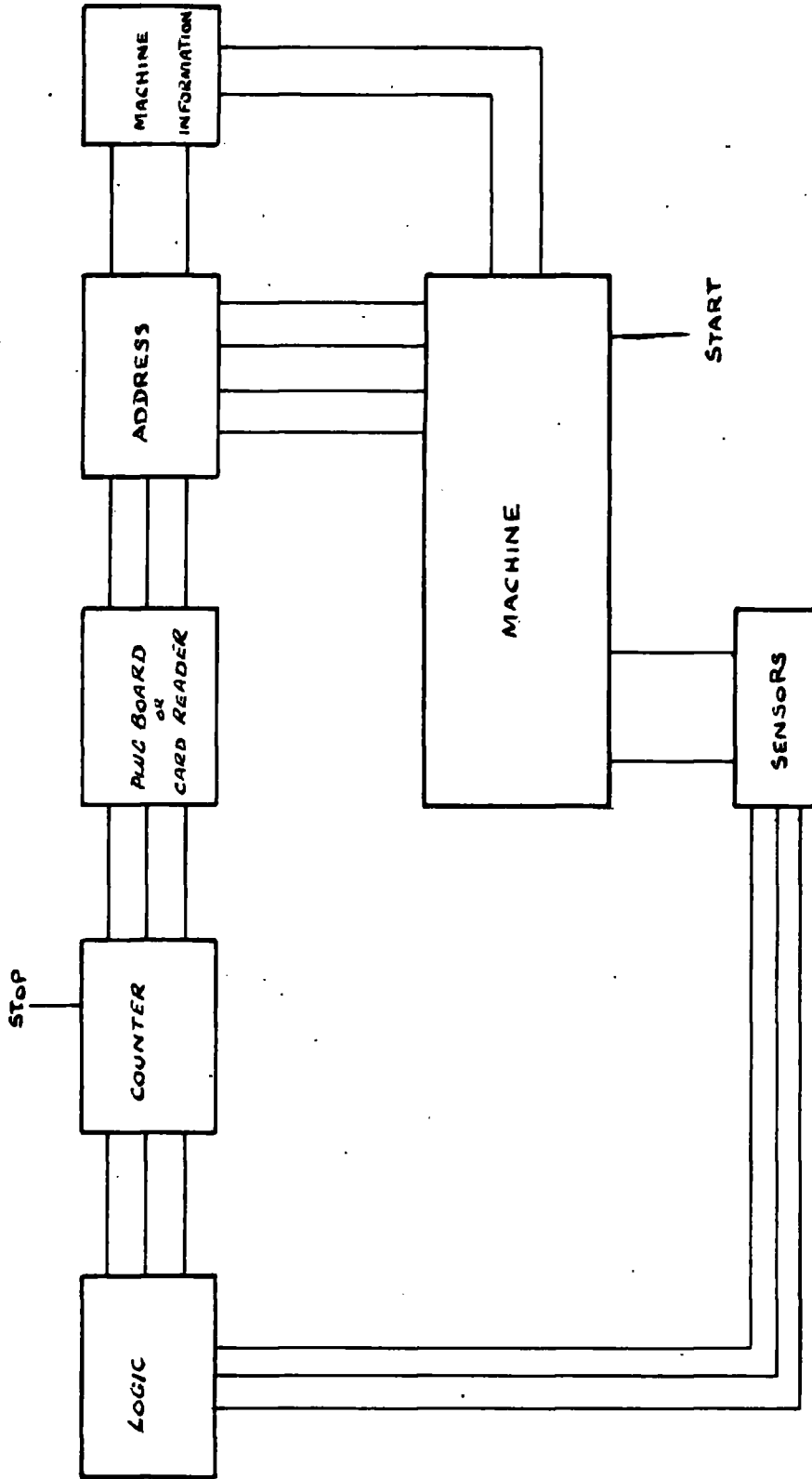

VARIABLE EVENT FLUIDIC SYSTEM. FIG. 5

elementary commercial stage, and that electronic sequence control systems have been used as a model in most instances. Commercially available electronic sequence control equipment has been developed to suit a wide field of application, and it is relatively simple to increase the capacity of a system with additional control cabinets. Unfortunately, the cost of a control cabinet is such that it has priced itself out of many low cost automation applications, and stimulated an interest in pneumatic and fluidic circuitry. Sophisticated fluidic control systems, fixed, variable and numerical, have been developed; some have been described by Charnley. (4)

The use of pneumatics in low cost sequence control has also been advanced, with the formation of Low Cost Automation Centres throughout the country, a combination of courses in circuit design, component appreciation, the low component cost, and the realisation that a considerable increase in production output can be achieved, with a relatively small increase in capital expenditure. Extensions to the range and miniaturisation of pneumatic components, has increased the field of application. In the past, pneumatics were restricted to material handling problems where cylinders were manually or trip valve operated. Today, quite complex interlocked sequence circuits incorporating timed delays on certain cylinders are in common use and suitable for drill, press or similar processes. There are many limitations; the number of valves necessary for logic functions, slow response time, the force and travel necessary to operate trip valves. Physical dimensions and the quantity of air consumed, all prevent the satisfactory performance of complex circuits. The introduction of wall attachment and beam deflection fluid logic devices into pneumatic circuits removed many limitations. There are no moving parts to malfunction and they have a quicker response, with a low air consumption. The compact breadboard design is ideal for small logic circuits and to prove the more complex circuits prior to the manufacture of integrated circuits.

A data signal from a machine is supplied by a mechanically operated limit switch in electronic and pneumatic circuits. In fluidics, by a sensing device, which detects a variation in air pressure and has no moving parts. This device gives fluidics an important advantage that has not been fully exploited. The sensitivity and reliability of back pressure switching devices are superior to those utilised in electronics and pneumatics. A sensing head is simple in design, easy and cheap to produce and

has a low air consumption. At present, the principle applications are counting and sensing the presence of components, or interlocking functions where light weight components will not operate a limit switch. The relatively expensive light or sound devices are unsuitable due to size or working conditions. A back pressure signal device can be used in conjunction with other fluidic devices, or actuate a diaphragm valve to control a cylinder travel and stop the motion within approximately 0.001 of an inch. Alternatively, a more complex fluidic device with a bias control signal can be used which will detect pressure variations of less than 0.25 inches of water gauge. As a result of their sensitivity, fluidic sensing devices can be successfully applied to detect pressure variation, the proximity of objects, the change in viscosity of fluids and temperature change.

With the use of multiple banks of fluidic sensing devices, the linear control of machine tool slides and their accurate positioning, may be achieved at a relatively low cost when compared with electronic positioned control.

2.5. General Requirements of a Linear Programmed Variable Event Fluidic System

The control systems outlined in Chapter 2.2. and 2.3. utilised in the low cost automation of turret lathes provide:

1. Power traversing of tool slides.
2. Operational sequence, usually related to ram motion.
3. Selection of speed.
4. Selection of tool slide feed.
5. Change from tool slide quick traverse to feed traverse.
6. Operation of collet, bar feed or loading mechanism.
7. Co-ordination of turret and cross-slide motion.

It is not possible to programme the distance to be travelled by the turret slide: component length control is achieved by using a mechanical stop, or limit switch which is positioned by the machine setter.

2.5.1. Fluidic Sensing Units for Linear Control

The sensing head shown in Figure 6, has a 0.030 inch diameter orifice, and when used to control the linear position of a tool slide will give a repeatability of position within 0.001 of an inch. To programme any distance over a 4.00 inch length in increments of 0.001 in. would require 4000 devices. Each orifice would have a

FLUID SENSING HEAD.

FIG. 6.

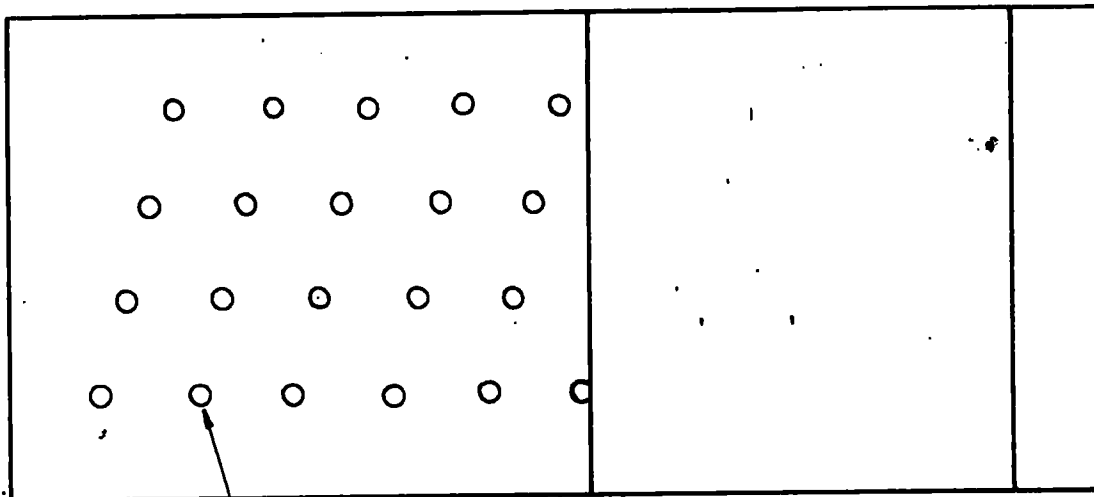
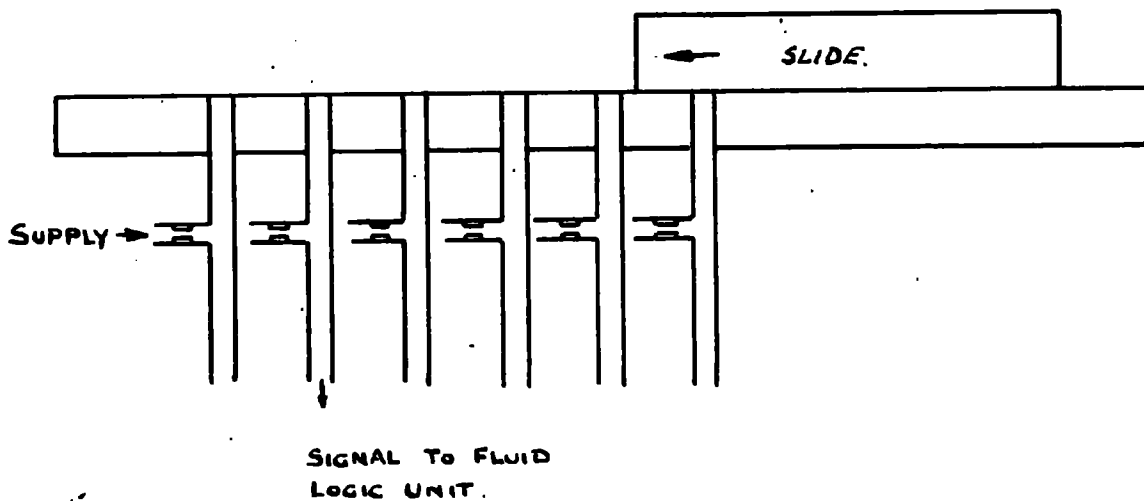

POSITION OF SLIDE DETECTED BY AN
ARRAY OF SENSING HOLES.

linear advancement of 0.001 in. on its predecessor, but as 0.1875 in. centres between each orifice is desirable to facilitate signal pipe connections, they would have to be inclined at an angle. Signals from the sensing unit could be obtained by having a pressurized bar probe travelling along the unit. As it passed each orifice, air would be transferred to the signal pipe. Alternatively, air could be supplied to a particular orifice, which when covered by a solid probe preventing the air venting to atmosphere; would produce an increase in signal pipe pressure. In the first method, the signal would be dissipated over several devices due to the size of the orifice and the centre distance. This coupled with signal pipe resistance, would give an extremely weak signal, which could be amplified, but the result would be a slower response time. The second method would give a back pressure signal, that increases in strength as the probe covers the orifice; air supply pipes would be shorter, have a lower resistance and the result would be a stronger signal with a quicker response.

2.5.2. Selection of a Sensing Orifice

A fluidic system capable of selecting any one of 4000 sensing devices would be required; this is beyond the capacity of existing fluidic programmers. This is one of the principle reasons why linear control is not programmed in sequence control systems, another being the number of signal pipes on the machine tool. A more versatile sequence control system would have, in addition to the points mentioned in Chapter 2.5.

1. Programmed turret slide travel over a suitable length in increments of 0.001 inch.
2. A method of programming which can be prepared by shop floor personnel and modified to suit the actual working conditions.
3. The minimum number of power and signal pipes to the machine tool in order to facilitate machine operation, maintenance and safety.

In order to develop a linear programmed sequence control system using fluidics, the following difficulties, their relationship to other functions, and possible solutions were studied.

2.5.3. Reductions in the Number of Pipes to the Machine Tool

The piston of a slave cylinder having the same cross-sectional area as the turret slide actuating cylinder, would move the same distance if operated by the turret slide cylinder exhaust fluid. The slave cylinder, fitted with sensing devices and mounted in a cabinet with other control equipment, could be situated at any convenient position for the operator. No fluidic signal pipes for linear programming would go to the machine, they would be enclosed and protected in the cabinet, shorter in length reducing resistance, capacitance and response time. Travel of the slave cylinder piston could be limited to a controlled length of turret slide travel, the distance necessary for turret indexing excluded. Two fluidic signal pipes would be required from the machine in addition to the cylinder pipes; one to inform the logic system that the turret has indexed; the other to inform logic, that the controlled turret slide travel has started and would switch the exhaust fluid from a storage tank to the slave cylinder.

2.5.4. Reduction in the Number of Sensing Unit Signal Pipes

The positioning of 64 sensing devices at 0.0625 inch centres would give linear positional control over a 4 inch length in increments of 0.0625 in. The use of a slave cylinder, smaller in diameter than the turret slide actuating cylinder, could be used to amplify linear motion. For example, a 3 inch diameter cylinder piston which moves 0.0625 in. will displace sufficient fluid to move the piston of a 0.5 inch diameter cylinder 2 inches. With sensing devices positioned at 0.03125 inch centres on the 0.5 inch slave cylinder, each increment, would be equivalent to the 0.001 inch movement of a 3 inch diameter slave cylinder. By programming the 3 inch cylinder sensing devices to the nearest 0.0625 inch under the required length of travel, then switching the fluid to the 0.5 inch cylinder programmed for the remaining distance, any length up to 4 inches, in increments of 0.001 inch, could be obtained with 128 sensing unit fluidic pipes instead of 4000. Assuming the valve response remains constant, a repeatability of approximately ± 0.001 inch should be obtainable.

2.5.5. Operation Sequence

Operational sequence is related to the movement of the turret slide, the engagement of feed and cross-slide tools by its linear

position. The selection of spindle speed, rate of turret slide feed, or collet operation is controlled by the tooling arrangement on each turret face. A range of switches could be used to programme these requirements; six sets would be required, one for each turret face, similar to some electronic systems. When the turret slide has travelled the required distance, it will return, index to present another tooled turret face and signal the logic system; the next row of programme switches will be activated.

2.5.6. Control of Turret Slide

To control the distance travelled by the turret slide, it must be possible to select any one of the 64 sensing devices fitted to each of the slave cylinders. Two sixty four, position programme selector switches would therefore be required, in addition to suitable programmers to select speed, rate of turret slide feed etc. A summary of the programming requirements for each turret face is:

1. One 64-position programmer to select turret slide travel in 0.0625 inch increments.
2. One 64-position programmer to select turret slide travel in 0.001 inch increments.
3. One 64-position programmer to stop the quick traverse and engage the turret slide feed.
4. One 64-position programmer to co-ordinate the cross-slide with the turret slide motion.
5. One 8-position programmer to select the turret slide feed.
6. One 12-position programmer to select the spindle speed, the forward, stop and reverse motion; this unit will also operate the collet when the "stop" position is programmed.

Each turret face would require a minimum of 276 control signal outputs, a total of 1,656 before the hexagon turret and cross-slide can be programmed. This quantity of output signals is beyond the capacity of existing fluidic programming equipment, except punched tape block scanning. To extend a drum or pegboard programmer would make it too bulky, and the preparation, or modification of existing programmes is limited to present day practice.

2.5.7. Programming

Existing techniques for programming cannot meet the requirements of a linear programmed variable event fluidic sequence control system for a turret lathe. The only available fluidic

selector switch provides four output signals. The design and development of a six channel, sixty four selection programme unit was therefore a necessity. Each selector unit is to be suitably engraved with the appropriate units or functions, similar to existing machine tool practice, so by turning a control dial, the machine setter or operator could select or modify the programmed speed, or distance travelled by the tool. Signal pipes from the programme and sensing units are connected to the logic system of wall attachment and beam deflection fluidic devices, which control the operation of diaphragm valves in the pneumatic and hydraulic systems.

CHAPTER III

General Features of Design

In order to clarify the requirements of a linear programmed variable event fluidic control system such as outlined in Chapter II, the block diagram Figure 7 was prepared to show the relationship between the various units. From this diagram the system was detailed into the following:-

1. Turret slide power cylinder and sensing unit.
2. Cross-slide power cylinder and sensing unit.
3. Slave cylinder with a sensing unit for 0.0625. inch increments of turret slide travel.
4. Slave cylinder with a sensing unit for 0.001. inch increments of turret slide travel.
5. Programme units.
6. Logic system.
7. Address system,

Items 1 and 2 are integral parts of the machine tool, item 1 being fitted to the turret slide and item 2 to the cross-slide; the remaining items are fitted in a control cabinet. The block diagram Figure 8 illustrating the relationship between turret slide power and slave cylinders, feed control and logic system; Figure 9 illustrates the cross-slide arrangement.

3.1. Turret Slide Motion

Control of the turret slide motion is achieved with the pneumatic-hydraulic turret slide power cylinder, described in Chapter 5.3.1. Compressed air is directed by valves in the Address system to inlet 01. of the cylinder to move the piston and turret slide forward. Hydraulic fluid in the opposite side of the cylinder, is forced through outlet 02 and directed to a storage tank, or either the large or small slave cylinder by the Address system. The rate of hydraulic fluid flow is restricted to control the speed at which the turret slide moves forward. Data signals from the slave cylinder sensing units, inform the logic system when the programmed length has been traversed by the turret slide.

LINEAR PROGRAMMED VARIABLE EVENT FLUIDIC SYSTEM

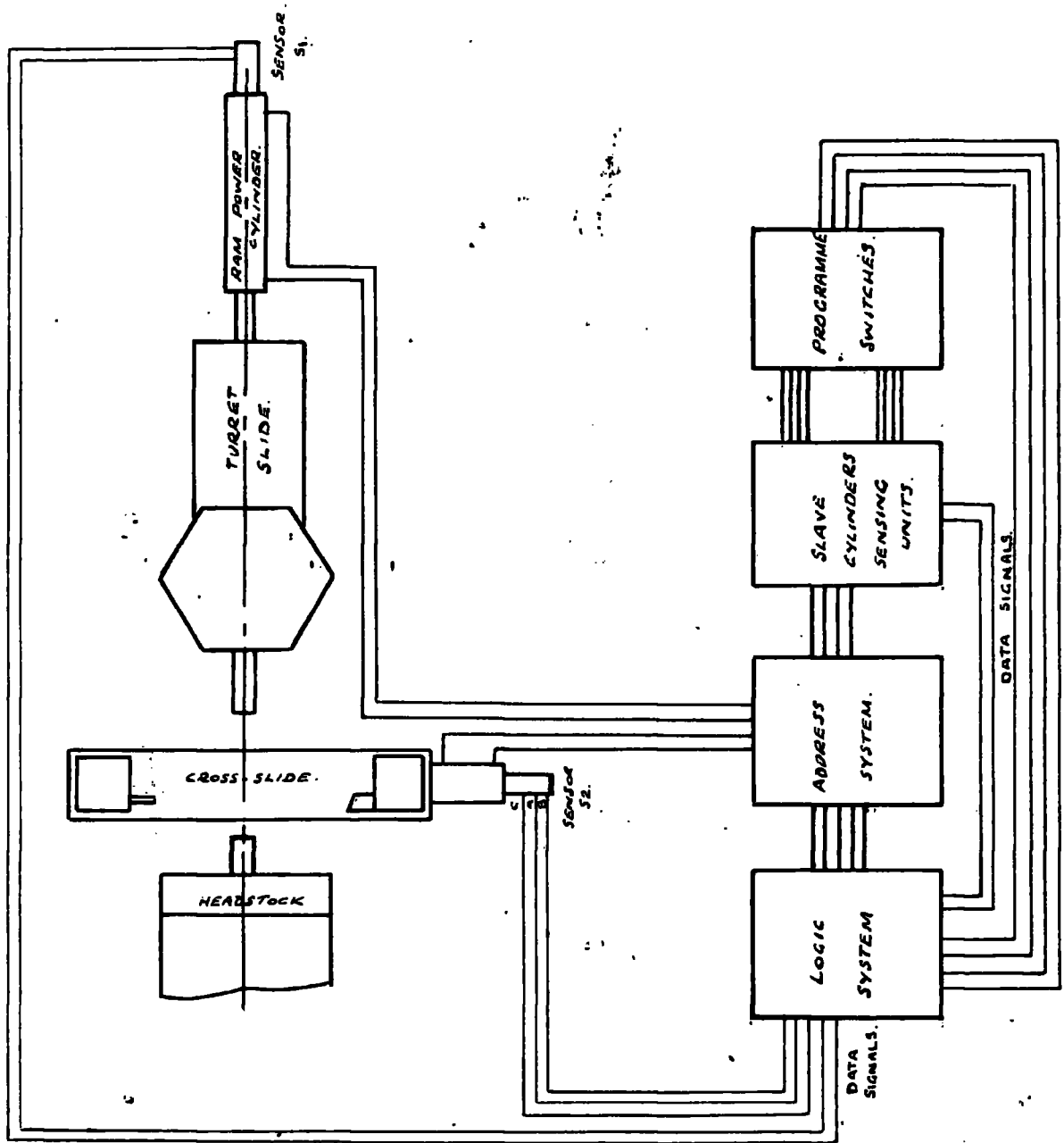
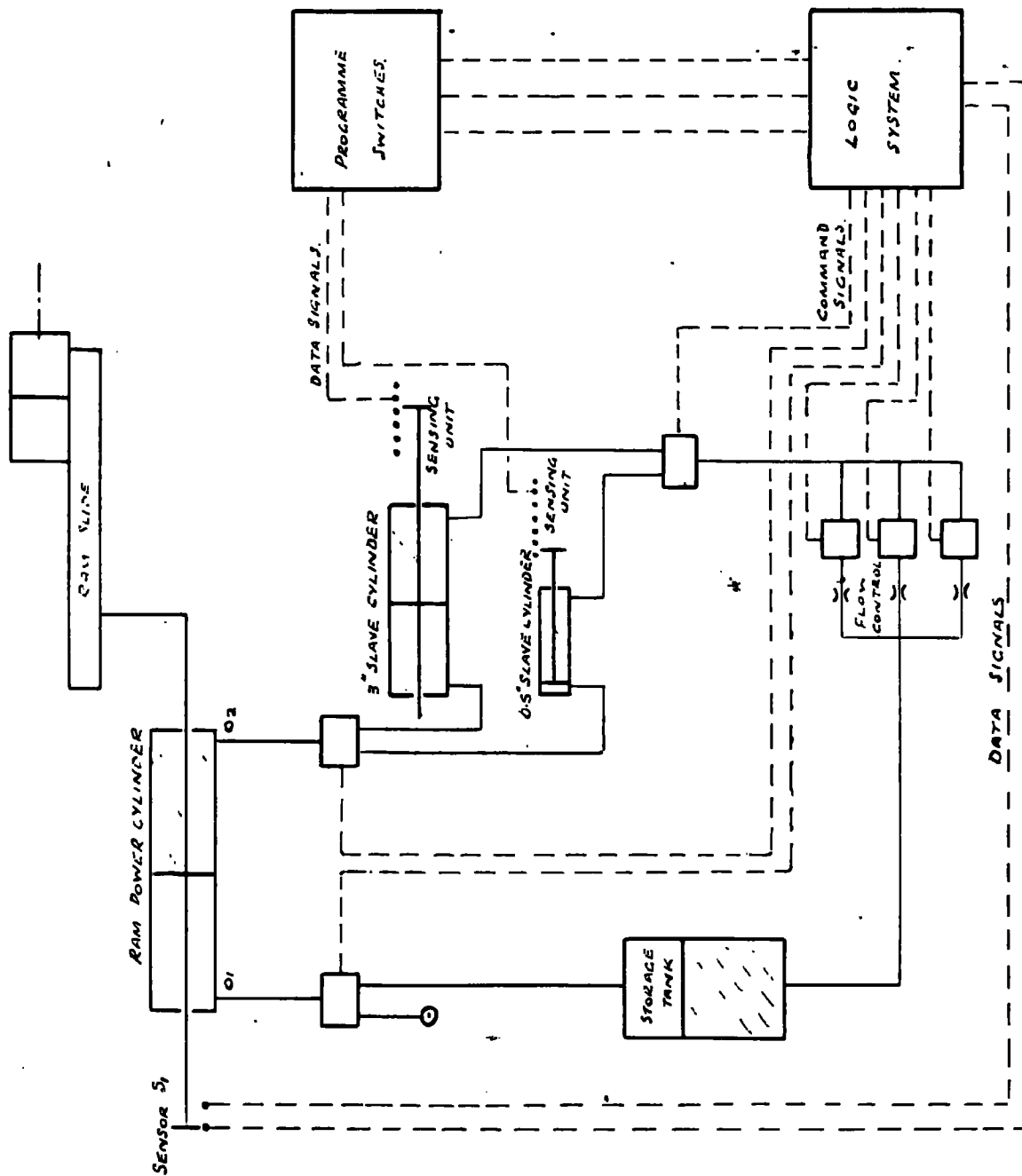

FIG. 7.

TURRET SLIDE MOTION.

FIG. 8.



CROSS-SLIDE MOTION.

FIG. 9.

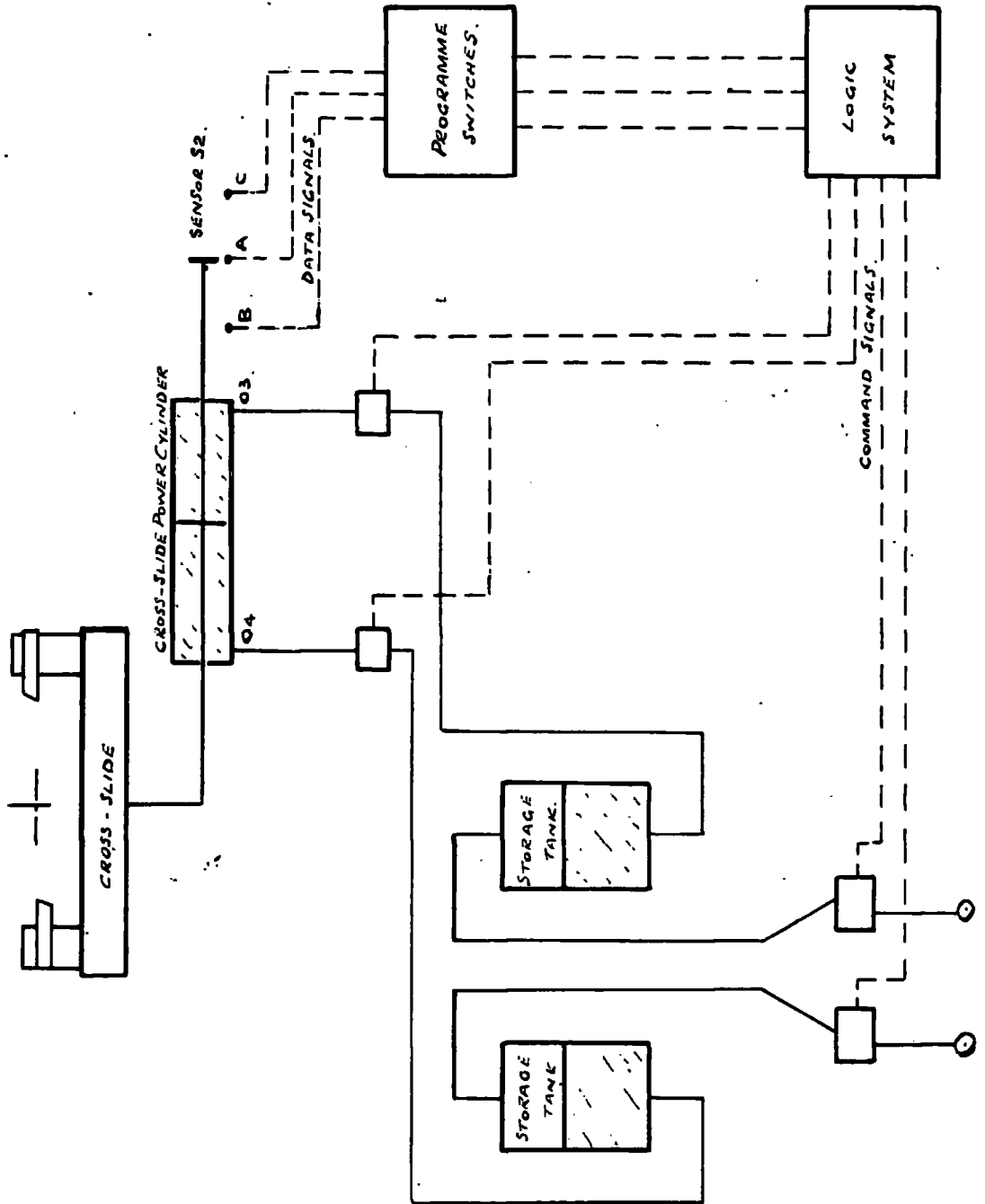

A command signal from "Logic" to "Address", reverses the fluid flow and the direction of turret slide traverse, until a data signal from sensor S1, informs "Logic" that the slide has returned and the turret indexed. When other simultaneous operations have been completed, such as a cross-slide motion, the joint data signals from sensors S1 and S2 change the programme to the next sequence of operations.

3.2. Cross-slide Motion

The cross-slide, stationary in a central position until operated, is used for secondary machining operations, such as chamfering, recessing and parting off the finished component. It moves on average only twice during a cycle of turret operation. The cross-slide power cylinder, described in Chapter 5.3.2., is designed to stop in a central position, marked "A": the tools in the front and rear toolposts being pre-set from the component centre line. When the turret slide has reached a programmed position, the 3 inch diameter slave cylinder sensing unit issues a data signal to the Logic system, that it is time to start the cross-slide in motion. A command signal to "Address" operates valves and fluid is supplied to O3 when the front toolpost is required. Fluid exhausted from O4 is restricted to give the desired rate of cross-slide motion. When the sensor at position "B" is activated, the resulting data signal informs "Logic" that the cutting tool has reached its pre-set distance from the component centre-line. A command signal to "Address" reverses fluid flow and the cross-slide motion reverses until the sensor at position "A" is activated. The data signal informs "Logic" and a command signal to "Address" locks the cross-slide in a central position until required for the next operation.

3.3. Control of Turret Slide Length and Related Operations

The 3 inch diameter slave cylinder and sensing unit described in Chapter 5.4.1. repeats the motion of the turret slide power cylinder, and is used to initiate feed and speed changes, quick traverse of turret slide, and start the cross-slide in motion. In addition, it controls the turret slide traversing length in increments of 0.0625 inches. The programmers select certain sensors of the slave cylinder sensing unit for the above functions; any movement of the turret slide is repeated by the slave, which moves a probe along the sensing unit. When each programmed sensing device is activated to produce a data signal for the Logic system, the Address system

receives a command to perform the appropriate function. When the programmed length to the nearest 0.0625 inch under the component length is reached, a data signal from the 3 inch slave cylinder sensing unit initiates a command to "Address". Fluid from the turret slide power cylinder is switched to the 0.5. inch diameter slave cylinder, described in Chapter 5.4.2., which amplifies the remaining distance to be travelled by the turret slide. The programmed sensing device on this unit is designed to give 0.001 inch increments of turret slide travel, which will be activated by a probe when the desired length is reached. When the switch over from the large to small slave cylinder occurs, the programmed rate of feed is reduced to a ~~creep~~ feed, preventing slide over-run. When the programmed 0.001 inch sensing device data signal stops the turret slide traverse, the spindle rotation ceases to prevent tool marks on the component, as the turret slide motion is reversed. At this stage, the collet chuck will be operated if programmed.

3.4. Programme Selection Unit

The survey of existing systems and equipment, described in Chapter II, confirmed that there was not a compact programme unit suitable for this type of control system, which requires a six channel sixty four selection output unit. Three basic methods were considered, the first a plug or pegboard arrangement; the second using an endless tape and the third, rotary dials. The pegboard arrangement was eliminated due to size; an investigation into the other two methods indicated that either would be suitable, providing a satisfactory seal could be obtained between the sliding surfaces to prevent a drop in air pressure. The prototype designs showed that the endless tape unit was larger, not as compact, and less suitable for incorporation with integrated circuits, than the rotary dial unit. Both types of programme units were eventually developed; the rotary programme unit, described in Chapter 5.4.3. was the first to be selected and fitted into the control system but was replaced by the endless tape programme unit described in Chapter 6.2.5.

3.5. Logic System

The Logic system, comprising of such fluid logic devices as bistable, monostable and other modules, was divided into the following circuits:-

1. Channel selection or count circuit.

2. Cross-slide valve control,
3. Feed selection,
4. Programme selector switchboard,
5. Speed selection and collet operation,
6. Turret slide valve control.

The function of each circuit is described in Chapter IV; the piping arrangement and truth tables are shown in the diagrams, figures 10 to 15. The completed sub-assemblies are described in Chapter 5.5.3. and illustrated in figures 47 to 50. The relationship between Logic and Address systems is shown in Figure 18 Chapter 4.2.9.

3.6. Address System

The Address system controls the machine tool motions and is activated by command signals from the Logic system. It is divided into two sections, one controlling the cross-slide which is illustrated in Figure 16 and described in Chapter 4.2.7. The other, illustrated and described in Figure 17 Chapter 4.2.8., controls the feed, speed, collet and turret slide operation. The block diagrams, Figures 8 and 9, illustrate the relationship of the various components and other systems, but for a comprehensive schematic arrangement, Figure 18 should be consulted. The system consisting of hydraulic fluid storage tanks, valves, flow regulators etc. is housed in a control cabinet, which is described in Chapter 5.5., and illustrated in Figures 37 to 43.

3.7. General Description

A summary of the components and units of a linear programmed variable event control system and their disposition is as follows:-

1. Turret slide power cylinder; pneumatic-hydraulically actuated and fitted to the machine turret slide; the sensing unit fitted, has two devices, one to give a data signal indicating the return and indexing of the turret; the other to inform "Logic" when the controlled length of turret slide travel has commenced.
2. Cross-slide power cylinder; hydraulically activated and fitted to the machine cross-slide; the fitted sensing unit having three devices to control front, back and central position.
3. Collet operating pneumatic cylinder to control the feed of bar stock.

4. Spindle speed control pneumatic cylinders operating electrical controls and friction clutch,
5. A Control Cabinet containing programme units, pressure controls, slave cylinders, sensing units, Logic and Address systems with data, pneumatic and hydraulic pipes connected to the machine tool.

CHAPTER IV

Fluidic, Pneumatic and Hydraulic Circuits

The requirement of the system, outlined in Chapter 2.5., design features discussed in Chapter 3, and the components reviewed, indicate a suitable breakdown of Logic and Address circuits, and the selection of various pneumatic equipment. Second generation wall attachment and beam deflection fluid logic devices, suitable for grid mounting were chosen. They are compact, robust, and reliable with pipe connections at the rear of the device. Cylinders suitable for pneumatic or hydraulic operation, low pressure operated diaphragm valves of fixed seal design so that flow regulators could be fitted to either input or output ports, were chosen. Copper piping was used in the hydraulic and some pneumatic circuits for compactness, but in general, semi-rigid polythene was used for the pneumatic circuits and flexible polythene tube for fluidic circuits.

4.1. Circuit Structure

A preliminary circuit layout, similar to Figure 18, was prepared to show the relationship of the various functions and units. This rough layout was then sub-divided into the following functional circuits:-

1. Channel selection fluidic circuit to supply air to the correct channel of the programme units.
2. Cross-slide fluidic circuit to control the address circuits for cross-slide motion.
3. Feed selection fluidic circuit to operate the various flow regulators controlling the rate of turret slide motion.
4. Selector switchboard fluidic circuit which receives the back pressure signals from sensing units, and transmits amplified signals to the various logic circuits.
5. Speed selection and collet operation fluidic circuit which issues command signals to valves controlling the above, on receipt of data signals from the programme.

6. Turret slide valve control fluidic circuit which receives data signals from 4 and the turret slide power cylinder sensing unit, and issues command signals to valves controlling the pneumatic or hydraulic flow to the various cylinders.
7. Cross-slide pneumatic-hydraulic circuit which controls the cross-slide traverse, the valves being actuated by command signals received from 2.
8. Turret slide pneumatic-hydraulic circuit which controls the pneumatic supply to the turret slide power cylinder and storage tank on receipt of command signals from 6. Incorporated in this circuit are the flow regulating valves controlled by fluidic circuit 3; air supply to the various channels of the programme units controlled by circuit 1 and the speed-collet valves controlled by circuit 5.

4.2. Circuit Details

The preliminary sub-circuits, stated above were studied in detail, working diagrams prepared, truth tables compiled to check the logic, and a schematic circuit diagram of the system constructed. A description of each circuit, the components utilised and the operation are as follows:-

4.2.1. Channel Selection Fluidic Circuit. Figure 10

The circuit uses NOR logic to cancel unwanted signals from the Binary counters. It consists of three Binary Counters, six Nor gates, one micro-push button three-part valve, a capacitor and one And gate to interlock the circuit with turret slide motion. The circuit receives a count signal, from the turret slide power cylinder sensing unit as the turret indexes, to give an output from BC1. The second count signal gives an output from BC2 and the fourth count signal, an output from BC3. By connecting the Binary Counter outputs to Nor gates, any number from zero to seven may be obtained; in this instance only six are necessary, one for each turret face. The sixth count signal is used to re-set the Binary Counters to zero, but this must not occur until the sixth operation has been completed. The combined signals of the sixth count, and stop signal S2 from the 0.001 sensing unit on completion of the operational cycle, are connected to the And gate giving a timed delay signal, resetting the Binary Counters to zero. When the turret indexes and presents turret face number 1 to

CHANNEL SELECTION FLUIDIC CIRCUIT DIAGRAM.

COUNT SIGNAL FROM TURRET C.I.
40% OF SUPPLY PRESSURE

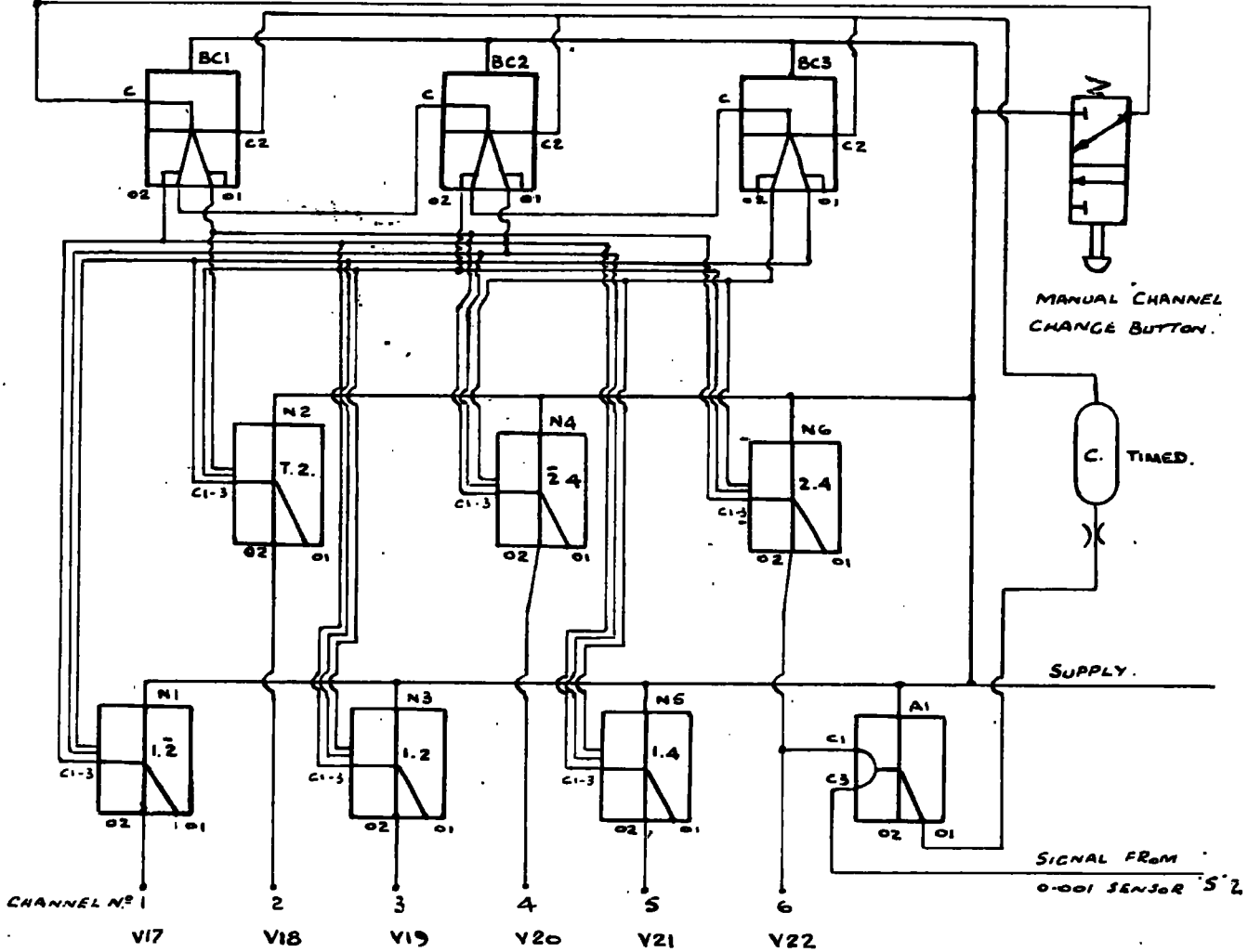

TRUTH TABLE

CHANNEL NR.	BC1				BC2				BC3				N1		N2		N3		N4		N5		N6		SENSOR	A1			
	C	O1	O2	C2	C	O1	O2	C2	C	O1	O2	C2	O1	O2	O1	O2	O1	O2	O1	O2	O1	O2	O1	O2		O1	O2		
0	0	0	1	1	0	0	1	1	0	0	1	1	1	0	1	0	1	0	1	0	1	0	1	0	1	0	S ₂	0	1
1	1	1	0	0	0	0	1	0	0	0	1	0	0	1	1	0	1	0	1	0	1	0	1	0	1	0	S ₂	0	1
2	1	0	1	0	1	1	0	0	0	0	1	0	1	0	0	1	1	0	1	0	1	0	1	0	1	0	S ₂	0	1
3	1	1	0	0	0	1	0	0	0	0	1	0	1	0	1	0	0	1	1	0	1	0	1	0	1	0	S ₂	0	1
4	1	0	1	0	1	0	1	0	1	1	0	0	1	0	1	0	1	0	0	1	1	0	1	0	1	0	S ₂	0	1
5	1	1	0	0	0	0	1	0	0	1	0	0	1	0	1	0	1	0	1	0	0	1	1	0	1	0	S ₂	0	1
6	1	0	1	0	1	1	0	0	0	1	0	0	1	0	1	0	1	0	1	0	1	0	0	1	1	0	S ₂	1	0

SIXTH COUNT AND SIGNAL FROM SENSOR RESET BINARY COUNTERS TO ZERO.

FIG. 10.

the component, the count signal energises channel number 1 of the programme units for the next operational cycle. The micro push button valve in the circuit provides manual channel change, so facilitating machine setting. The channel outputs are connected to and activate the three port valves controlling the supply of air to various programme circuits.

4.2.2. Cross-slide Fluidic Circuit. Figure 11

The circuit consists of one Schmitt Trigger, one Bistable, two Inhibited OR gates, one multivibrator, one binary counter and one digital amplifier. When the channel circuit has been activated, the programme unit, set for either front or rear tool post operation, provides a signal to the Schmitt Trigger. An output at O1 or O2 will set the bistable B1 output to the appropriate Inhibited OR gate, either I01 or I02. The cross-slide sensing unit with the probe in position "A" is giving a continuous signal to the multivibrator MV1, which converts it to a pulse count signal for the Binary Counter BC1; the O1 output, gives an output at O2 from the Digital Amplifier. This O2 output is the inhibiting control of I01 and I02 and prevents valves 10 and 11 operating. When the turret slide has travelled the programmed distance, a signal "S" from the 0.0625 sensing unit, resets BC1 to give output O2 which changes DA1 output to O1. The inhibiting control at I01 and I02 is removed, the valve 10 or 11, whichever is programmed, is activated. Simultaneously, valves 8 and 9 are activated to remove the hydraulic lock and the cross-slide traverses. On reaching the limits of its travel, the sensing unit signal from either position "B" or "C", reverses the bistable output to the Inhibited OR gate, and the flow of fluid is reversed to return the cross-slide to position "A". On reaching "A", the continuous signal to MV1 is converted to a pulse signal for BC1, which changes the output of DA1 to O2. All valves are now returned to rest and the cross-slide is again locked in a central position.

4.2.3. Feed Selection Fluidic Circuit. Figure 12

The circuit comprises of eleven Nor gates, three Inhibited Or gates, one bistable and a capacitor. Control signals, numbered 1 to 7, are connected to the turret slide feed programme unit. Whichever number is programmed provides a control signal to the appropriate Nor gate, which acts as an amplifier, and is fanned-out to control any or all of the Nor gates marked N8 to N10. Their output is used to control the outputs of Inhibited OR gates marked I01 to I03 which activate flow control valves. These valves are

CROSS-SLIDE FLUIDIC CIRCUIT DIAGRAM.

ROTARY SELECTOR SWITCH

CROSS-SLIDE SENSING HEAD.

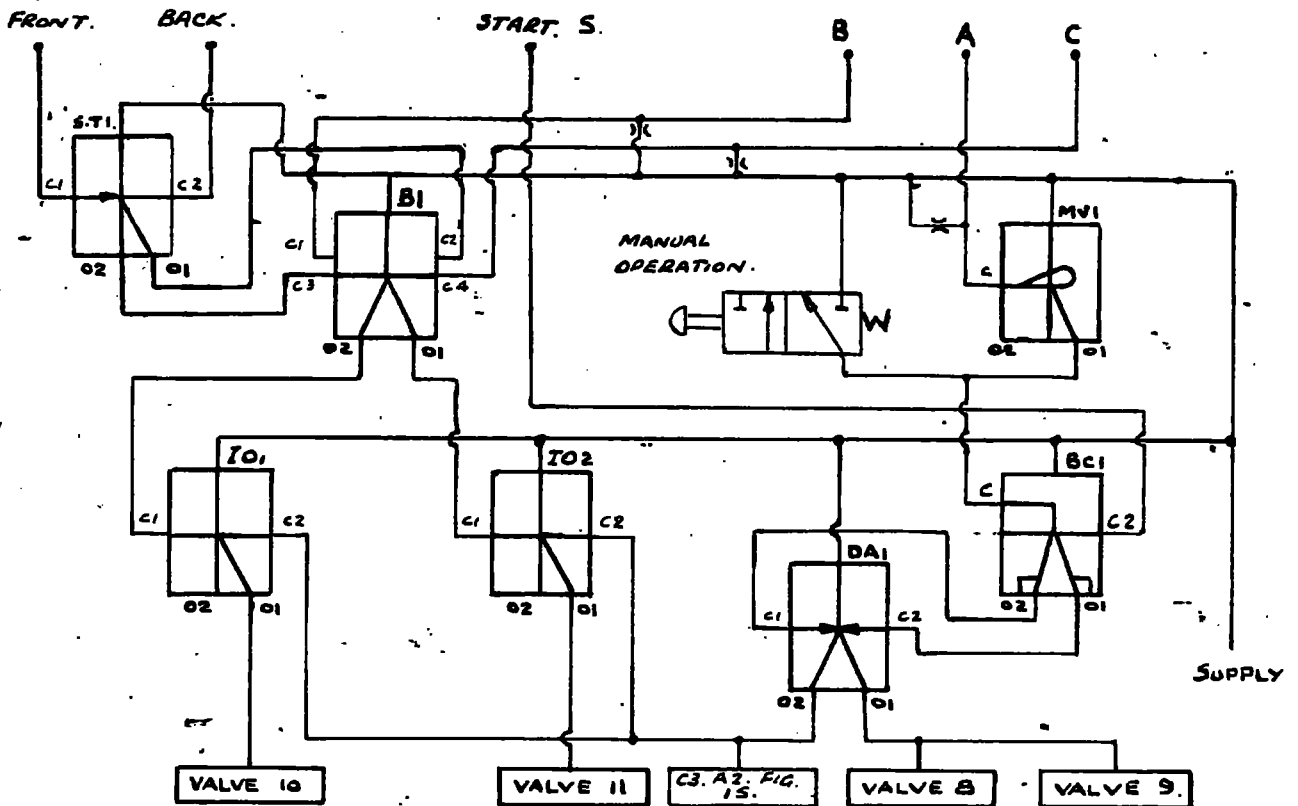

TRUTH TABLE.

CROSS-SLIDE POSITION	MVI		BCI			DAI		BI		IO1		IO2		B1	A	C1	START	STL		V10	V11	V9	V9	V13
	O1	O2	C	O1	O2	C2	O1	O2	O1	O2	O1	O2	O1					O2	B					
CENTRAL	1	0	1	1	0	0	0	1	0	1	0	1	0	1	0	0	0	0	0	0	0	0	0	1
SET TO MOVE	0	1	0	1	0	0	0	1	0	1	0	1	0	1	0	0	0	1	0	0	0	0	0	1
A TO B	0	1	0	0	1	1	1	0	0	1	1	0	0	1	0	0	1	0	1	1	0	1	1	0
REVERSE	0	1	0	0	1	0	1	0	0	1	1	0	0	1	0	0	0	0	0	0	1	1	1	0
STOP CENTRAL	1	0	1	1	0	0	0	1	0	0	0	1	0	1	0	0	0	0	0	0	0	0	0	1
SET TO MOVE	0	1	0	1	0	0	0	1	1	0	0	1	1	1	0	1	0	0	1	0	0	0	0	1
A TO C	0	1	0	0	1	1	1	0	1	0	0	1	0	0	0	1	0	0	0	1	1	1	1	0
REVERSE	0	1	0	0	1	0	1	0	0	1	1	0	0	1	0	0	0	0	1	0	1	1	1	0
STOP CENTRAL	1	0	1	1	0	0	0	1	0	0	0	1	0	1	0	0	0	0	0	0	0	0	0	1

FIG. 11.

pre-set to give flow ratios of 1, 2 and 4: if for example, feed number 5 is selected, Nor gates N8 and N10 provide a signal to the Inhibited OR gates I01 and I03; valves 3 and 5 are operated to give the sum of flow ratios 1 and 4. When the turret slide has travelled the programmed 0.0625 inch distance, stop signal "S1" from the 0.0625 inch sensing unit inhibits I03; valve 4 returns to rest and the flow or feed is reduced to flow ratio 1. When the programmed 0.001 inch distance is reached, stop signal "S2" from the 0.001 inch sensing inhibits I01, valve 3 is de-activated and the feed motion is stopped. A restricted "S2" signal charges the capacitor to give a timed delay; this allows the machine spindle to stop before the Bistable B1 de-activates valve 2 and the turret slide returns to index on the quick traverse.

4.2.4. Selector Switchboard Fluidic Circuit. Figure 13

This circuit consists of four Schmitt Triggers, one Multi-vibrator, one Bistable and one Digital Amplifier. The control signal pipes of the Schmitt Triggers are connected to the back pressure signal pipe of the appropriate programme unit, detecting any increase in pressure as the various sensors are activated, a Bias signal pressure setting the switching pressure. Output from the Schmitt Triggers are connected to a Multi-vibrator, when a pulse signal is required to prevent a fluidic device being "locked" to a particular output. A Bistable device is used when a continuous output is required after the control has been removed, or to a Digital Amplifier when the Schmitt Trigger will not fan-out the devices it controls.

4.2.5. Speed and Collet Fluidic Circuit. Figure 14

The circuit consists of two Nor gates, one Multi-vibrator, two Inhibited OR gates, one Bistable and two Micro toggle three part valves. Each additional speed will require a further Nor and Inhibited OR gate. When a forward speed is selected, the O1 output of N2 provides a continuous signal to I02, output from this device activating a valve to energise an electrical circuit. When the machining operation has been completed, the continuous stop signal S2 from the 0.001 sensing unit inhibits the control signal C1 of I02 to give output O2. The valve returns to rest, the motor stops, allowing the tool to withdraw and preventing a spiral tool mark being produced on the machined diameter. The collet is operated

FEED SELECTION FLUIDIC DIAGRAM.

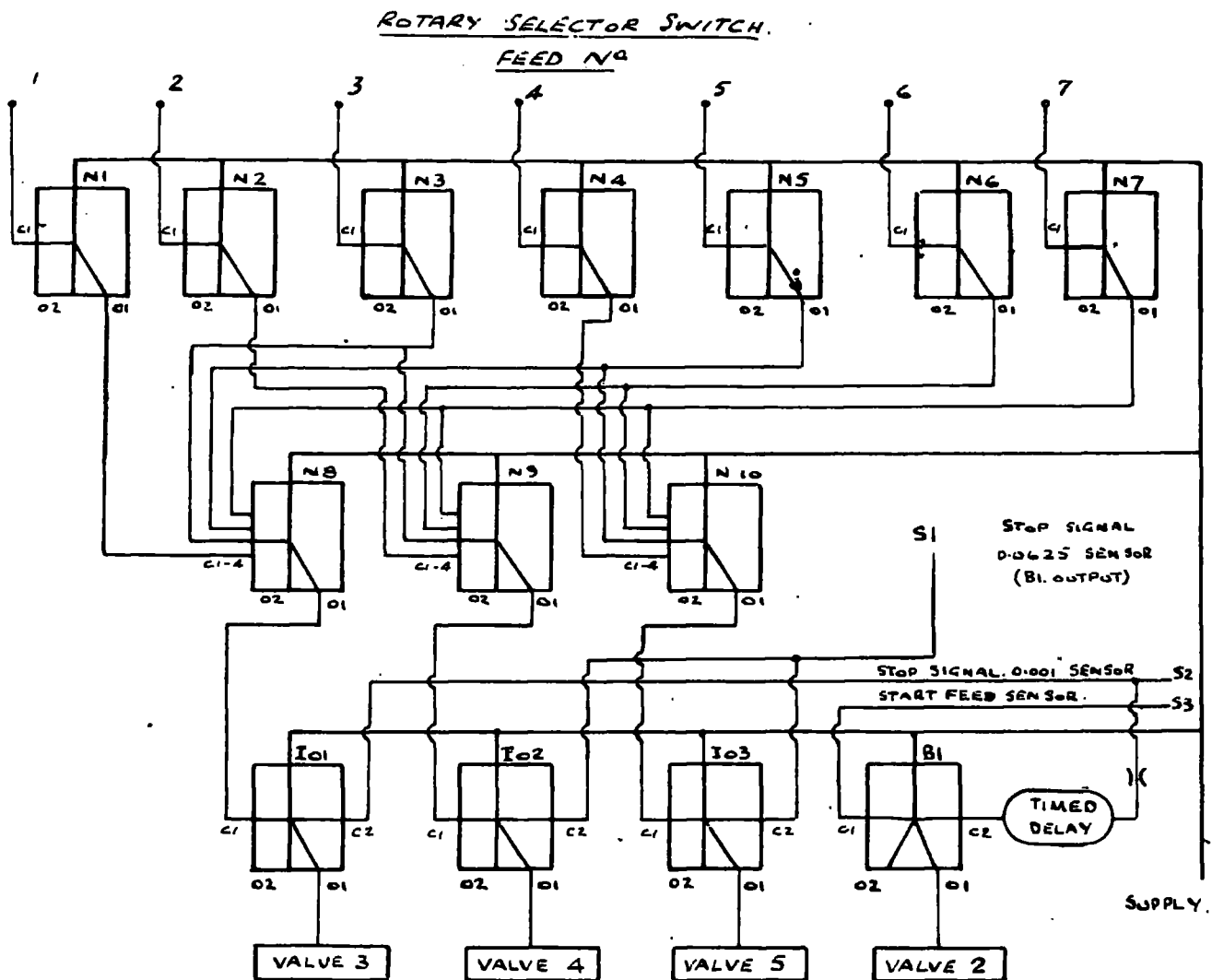

TRUTH TABLE FOR THE CONTROL AND SELECTION OF TURRET FEED.

TURRET OPERATION.	N										I0		I0		I0		B		SENSOR			VALVE					
	1	2	3	4	5	6	7	8	9	10	1	2	1	2	1	2	1	2	S1	S2	S3	2	3	4	5		
INDEX	01	01	01	01	01	01	01	01	01	01	01	02	01	02	01	02	01	02									
SELECT FEED																											
QUICK TRAVERSE	USE OF THESE							1	1	1	1	1	0	1	0	1	0	0	1	0	0	0	0	0	1	1	1
START FEED	GATES DETERMINED							1	1	1	1	1	0	1	0	1	0	1	0	0	1	1	1	1	1		
CREEP FEED	BY PROGRAMME							1	1	0	0	1	0	0	1	0	1	1	0	1	0	1	1	1	0	0	0
STOP TRAVERSE	ON ROTARY							1	0	0	0	0	1	0	1	0	1	1	0	1	1	1	1	0	0	0	0
REVERSE TRAVERSE	SELECTOR							1	1	1	1	1	0	1	0	1	0	0	1	0	1	0	0	1	1	1	1

FIG. 12

SELECTOR SWITCH BOARD FLUIDIC DIAGRAM.

0.001" SENSOR

0.0625" SENSOR.

0.001" LENGTH.

0.0625" LENGTH

START FEED

START CROSS-SLIDE

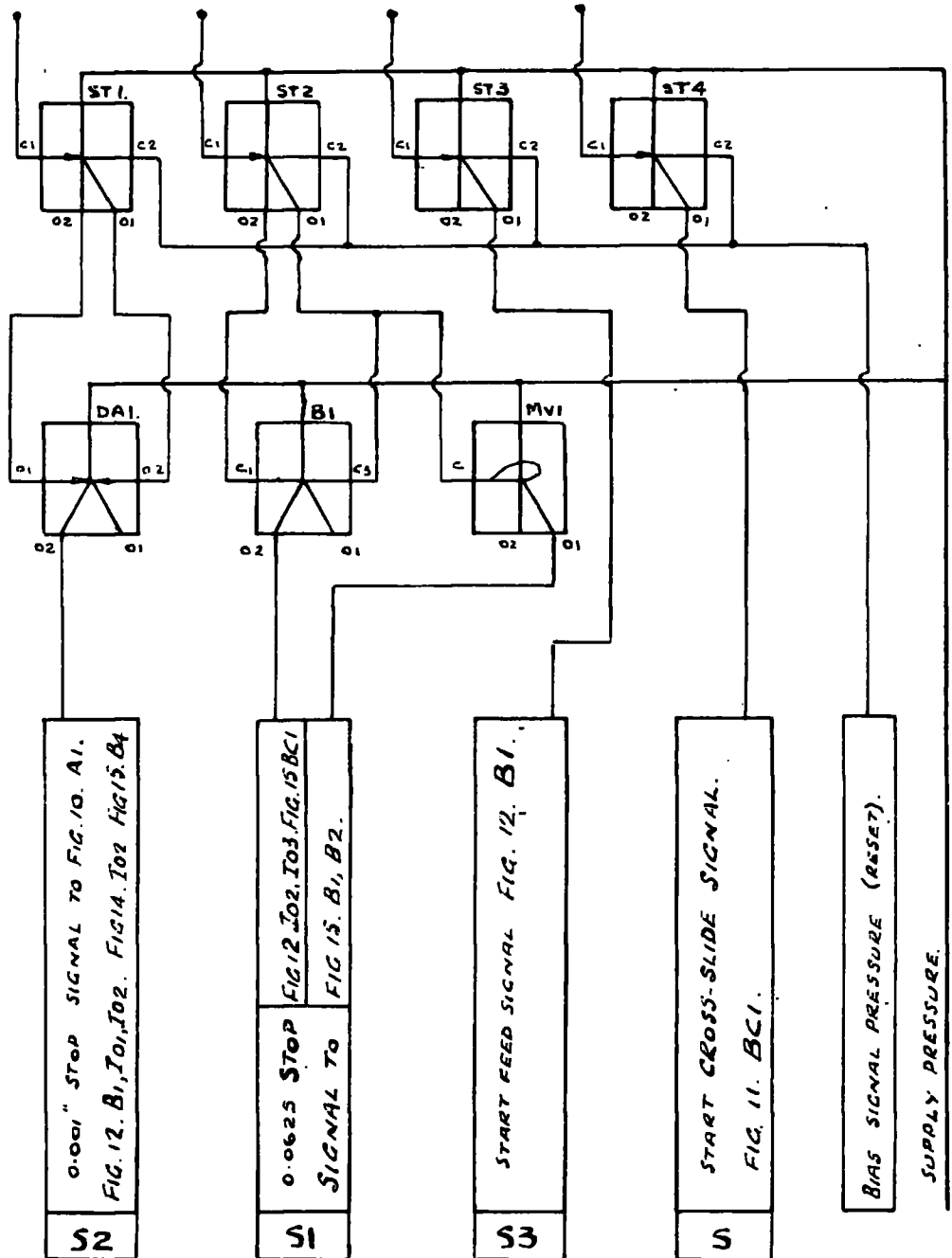
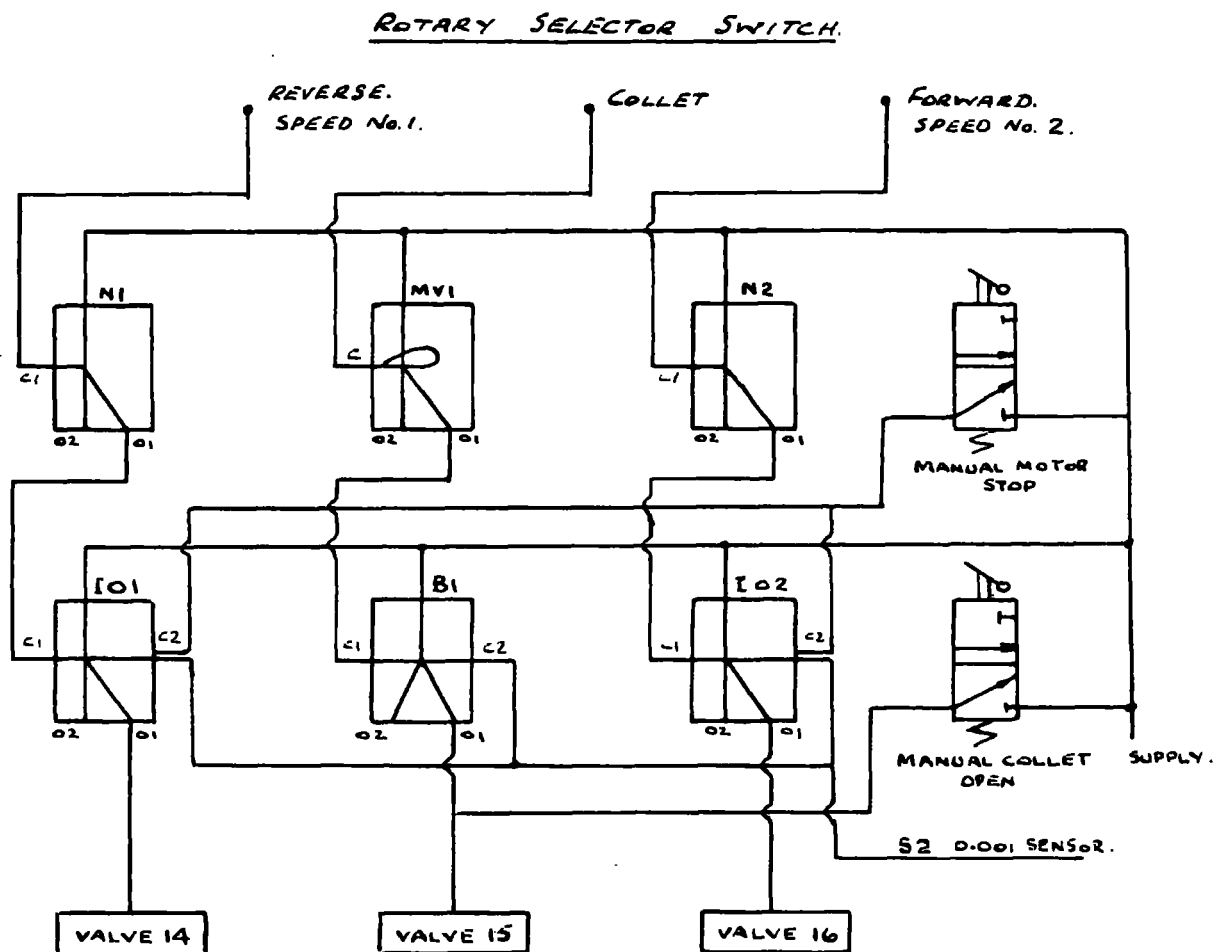

FIG. 13.

SPEED-COLLET FLUIDIC DIAGRAM.



TRUTH TABLE FOR SPEED-COLLET OPERATION.

PROGRAMMED OPERATION.	S W	N1		MVI		N2		IO1		BI		IO2		VALVE		
		01	02	01	02	01	02	01	02	01	02	01	02	14	15	16
INDEX TURRET - OPEN COLLET	0	0	1	1	0	0	1	0	1	1	0	0	1	0	1	0
STOP RAM TRAVERSE - CLOSE COLLET	1	0	1	0	1	0	1	0	1	0	1	0	1	0	0	0
INDEX TURRET																
SELECT FORWARD SPEED	0	0	1	0	1	1	0	0	1	1	0	1	0	0	0	1
STOP RAM TRAVERSE - RETURN	1	0	1	0	1	1	0	0	1	1	0	0	1	0	0	0
INDEX TURRET																
SELECT REVERSE SPEED	0	1	0	0	1	0	1	1	0	1	0	0	1	1	0	0
STOP RAM TRAVERSE - RETURN	1	0	1	0	1	0	1	0	1	1	0	0	1	0	0	0

FIG. 14.

only when it is necessary to feed out a new length of bar stock at the beginning of each cycle. The collet must remain open until the turret slide pushes it back, leaving only the required length of bar projecting, and then closing before the turret slide commences its return stroke. In order to achieve this sequence, the continuous collet signal is connected to MV1, the pulse output connected to switches the output and the valve is activated to open the collet. It will remain open until the programmed length stop signal S2 switches the output of B1 to O2 when the valve is de-activated. Toggle switches in both speed and collet circuits provide manual over-riding controls to facilitate machine setting.

4.2.6. Valve Control Fluidic Circuit. Figure 15

This circuit consists of four Bistable devices, one Binary Counter, one Schmitt Trigger, two And gates and one Multi-vibrator to control the turret slide motion. When the turret slide returns from an operation, the turret indexes and gives count signal C1, which in addition to operating the channel Selection Fluidic Circuit, gives an output from ST1 which is connected to one signal control of the And gate A2. Providing the cross-slide has completed its operation, and return to central position "A" to give a signal to the other control of A2, the five port valve number 13 is de-activated. Air is supplied to the turret slide power cylinder, forcing fluid from the opposite side of the piston into the hydraulic fluid storage tank. When the turret slide sensing unit gives signal C2 to BC1, it will switch And gate A1 output to O2 and Bistable B3 will operate valve 6, switching the fluid to the 3 inch slave cylinder. When the programmed 0.0625 inch distance has been reached, stop signal S1 connected to B1, B2 and BC1 switches the fluid to the 0.5 inch slave cylinder. The programmed distance of this slave cylinder gives stop signal S2, which becomes control signal C1 of B4; output is switched to O1 and valve 13 is activated to pressurise the storage tank. The turret slide power cylinder exhaust to atmosphere and the 0.5 inch slave cylinder returns back to give a continuous signal R3 connected to MV1. A pulse signal from MV1 changes the flow to the 3 inch slave cylinder which gives a continuous signal R2 when returned. Fluid flow is now direct to the returning turret slide power cylinder, which will give a further signal C2, setting the Binary Counter BC1 for the next cycle.

VALVE CONTROL FLUIDIC DIAGRAM.

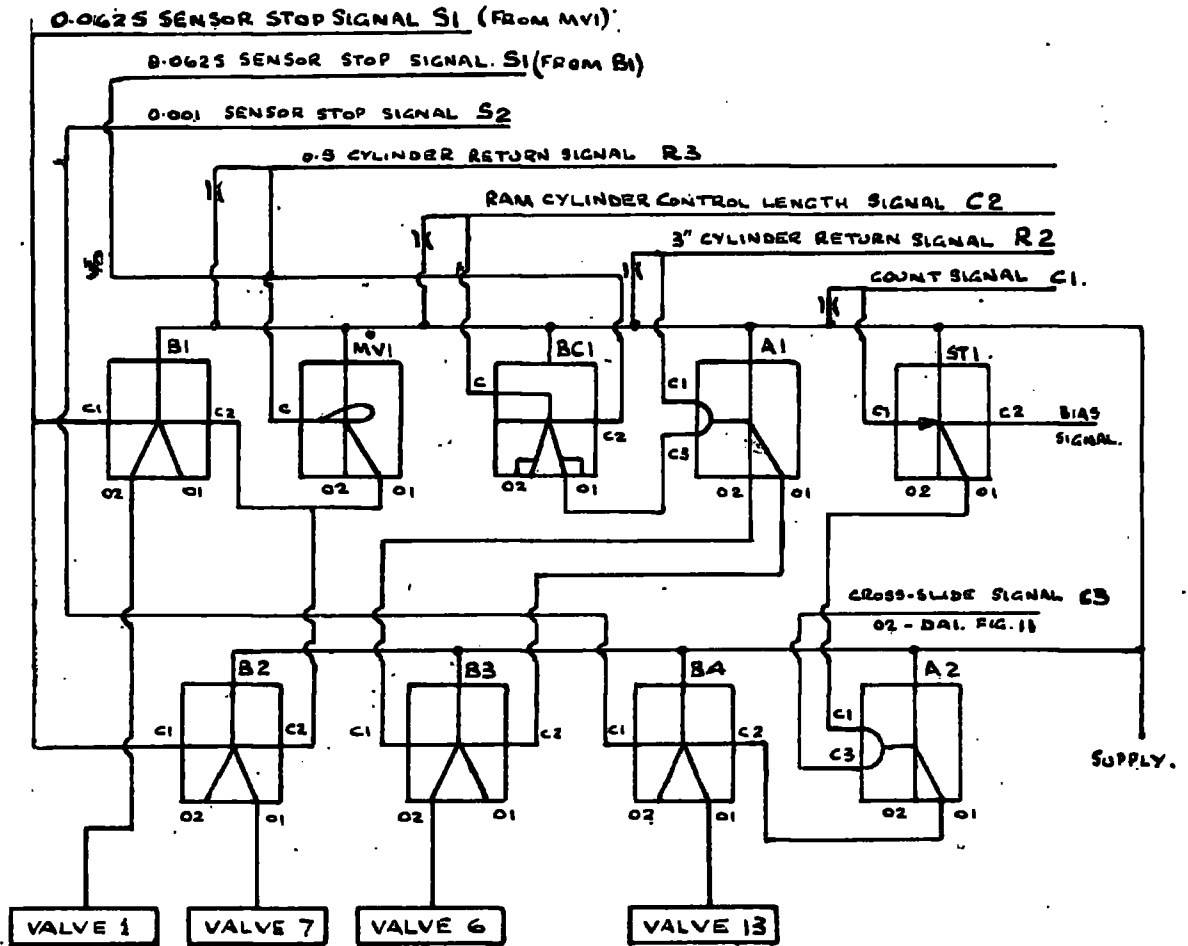

OPERATION.	SENSOR SIGNALS.	ST. 1		AZ		B4		BC1		A1		B3		MVI		B1		B2		CONTROL VALVES					
		01	02	01	02	01	02	01	02	01	02	01	02	01	02	01	02	01	02	1	6	7	13		
ALL CYLINDERS RETURNED	R3, R2, C2	0	1	0	1	1	0	1	0	1	0	0	1	1	0	1	0	0	1	1	3" SL	TANK	3" SL	AIR TANK	
INDEX TURRET FORWARD TRAVERSE	R3, R2, C1	1	0	1	0	0	1	1	0	1	0	0	1	0	1	1	0	0	1	"	"	"	AIR TANK		
CONTROLLED LENGTH RAM SIGNAL	R3, R2, C2	0	1	0	1	0	1	0	1	0	1	1	0	0	1	1	0	0	1	"	T SLAVE	"	"		
STOP 3" CYLINDER 0.0625 SENSOR	R3, S1	0	1	0	1	0	1	0	1	0	1	0	0	1	0	1	1	0	1	0	0.5 SL	"	0.5 SL	"	
STOP 0.5 CYLINDER 0.001 SENSOR	S2, S1	0	1	0	1	1	0	0	1	0	1	0	0	1	0	1	1	0	1	0	"	"	"	AIR TANK	
REVERSE RAM AND 0.5 CYLINDER	R3	0	1	0	1	1	0	0	1	0	1	1	0	1	0	1	0	0	1	1	0	0	1	3" SL	TANK
REVERSE RAM AND 3" CYLINDER	R3, R2	0	1	0	1	1	0	0	1	0	1	1	0	0	1	1	0	0	1	"	"	"	"		
CONTROLLED LENGTH RAM SIGNAL	R3, R2, C2	0	1	0	1	1	0	1	0	0	1	0	1	1	0	0	1	0	1	"	TANK	1	RAM	"	"
(CHECK) INDEX TURRET.	R3, R2, C1	1	0	1	0	0	1	1	0	1	0	0	1	0	1	1	0	0	1	"	"	"	"	AIR TANK	

FIG. 15.

4.2.7. Cross-slide Pneumatic-Hydraulic Circuit. Figure 16

This circuit consists of the 1.5 inch diameter cross-slide power cylinder (Figure 20), four Micro-diaphragm three part valves, two hydraulic fluid storage tanks and two Flow control valves. When the cross-slide power cylinder is central at position "A", valves 8 and 9 are at rest and the fluid on both sides of the cylinder piston is contained to give a hydraulic lock. To use the front toolpost, the fluidic circuit activates valves 8, 9 and 10, removing the hydraulic lock and pressurising fluid storage tank 1. Fluid is forced into one side of the cylinder; fluid from the opposite side is forced out and into fluid storage tank 2, which is now venting to atmosphere. On reaching position "B", valve 10 is de-activated, tank 1 exhausted to atmosphere, valve 11 activated to pressurise tank 2, and the fluid flow is reversed until the slide has returned to position "A". Valves 8, 9 and 11 are de-activated to give a hydraulic lock and exhaust tank 2 to atmosphere. A similar sequence occurs when the rear-tool post is used.

4.2.8. Turret Slide Pneumatic-Hydraulic Circuit. Figure 17

This circuit consists of the turret slide power cylinder (Figure 19), the 3 inch diameter slave cylinder and sensing unit (Figure 21), the 0.5 inch diameter slave cylinder and sensing unit (Figure 22), one Hydraulic fluid storage tank, one Five part diaphragm operated spool valve (number V13) for air control and seven - three part micro diaphragm valves (number V1 to V7) for fluid control, three - three part micro diaphragm valves (numbers V14 to V16) for speed and collet operation and six - three part micro diaphragm valves (numbers V17 to V22) for channel circuit air supply. The valves in this circuit are activated by the programme units and channel selection fluidic circuit. To move the turret slide forward, V13 is activated; air is supplied to the turret slide power cylinder and fluid in the opposite side of the cylinder is forced into the storage tank which is vented to atmosphere. When position C2 is reached, V6 is de-activated and fluid is directed through V7 to the 3 inch diameter slave cylinder. Fluid from the opposite side of the slave cylinder flows through activated V1, the flow control valves 3, 4 and 5, then into the fluid storage tank. When the programmed feed commences, V2 is activated and the fluid flow is through any or all of V3, V4 or V5 until stop signal S1 de-activates valves V4 and V5, to leave only the creep feed, V3 in

CROSS-SLIDE PNEUMATIC-HYDRAULIC CIRCUIT.

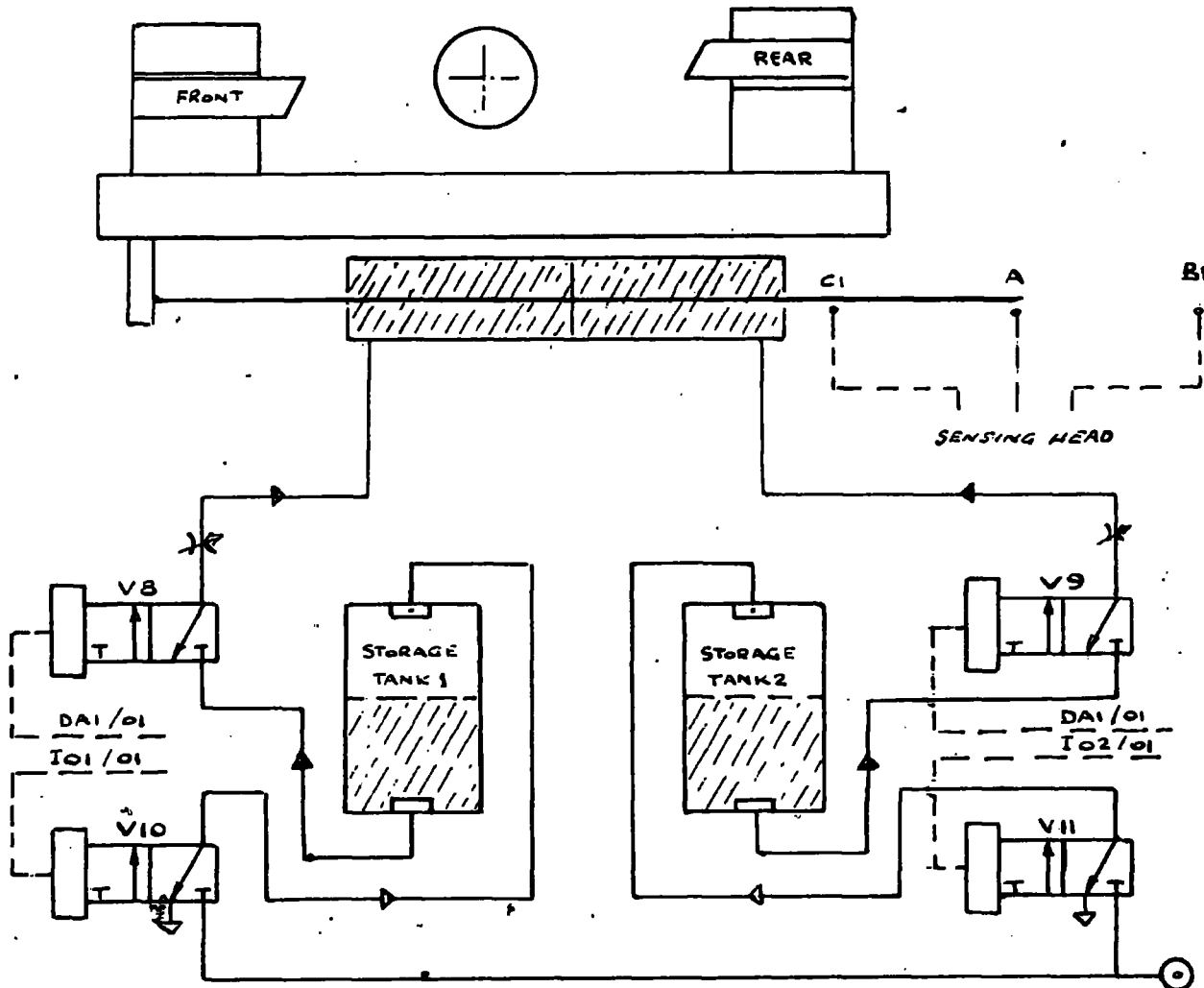

CROSS-SLIDE OPERATION	VALVE N ^o				REMARKS.
	8	9	10	11	
CROSS-SLIDE CENTRAL. A.	0	0	0	0	ALL VALVES CLOSED, CYLINDER LOCKED CENTRAL. STORAGE TANKS EXHAUST TO ATMOSPHERE
FRONT TOOL POST. MOVE A TO B1	1	1	1	0	STORAGE TANK 1 PRESSURISED. FLUID FLOW TO AND FROM CYLINDER.
REVERSE. TRAVERSE B1 TO A	1	1	0	1	STORAGE TANK 1 EXHAUSTED. TANK 2 PRESSURISED
CROSS-SLIDE CENTRAL A	0	0	0	0	ALL VALVES CLOSED, CYLINDER LOCKED CENTRAL. STORAGE TANKS EXHAUST TO ATMOSPHERE
REAR TOOL POST MOVE A TO C1	1	1	0	1	STORAGE TANK 2 PRESSURISED. FLUID FLOW TO AND FROM CYLINDER
REVERSE TRAVERSE C1 TO A	1	1	1	0	STORAGE TANK 2 EXHAUSTED. TANK 1 PRESSURISED

FIG. 16.

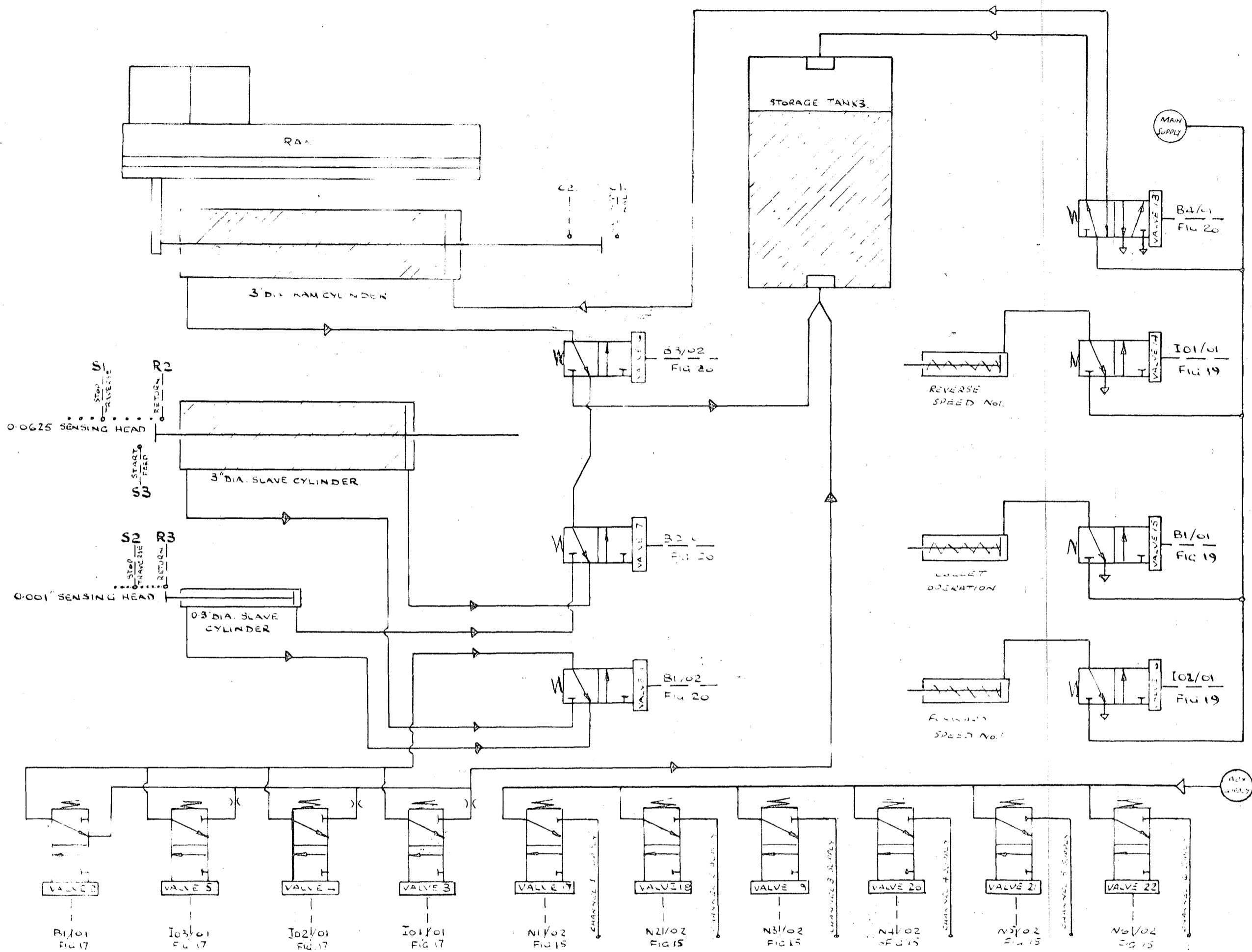

PROGRAMMED OPERATION	SENSOR SIGNAL	VALVE													REMARKS
		1	2	3	4	5	6	7	8	9	10	11	12	13	
INDEX TURRET-SELECTED CHANNEL-SPEED FEED-LENGTH-CROSS SLIDE	C1 R1 R2 C3	1 No FLOW	1 TANK TO RAM	0 3" SL TO RAM	1 AIR TO RAM	0 NOT REQ?	0 NOT REQ?	1 FORWARD SPEED	0 FULL FLOW	1 PART FLOW	1 PART FLOW	1 PART FLOW	1 PART FLOW	CROSS-SLIDE CENTRAL FLUID DIVERTED BEFORE REACHING C.S.S.	
CONTROLLED LENGTH RAM TRAVEL COMMENCING	C2 R2 R3	1 FLOW TO 3" SL	0 RAM TO SLAVE	0 3" SL TO RAM	1 " "	0 " "	0 " "	1 " "	0 " "	1 " "	1 " "	1 " "	1 " "	ALL FEED VALVES OPEN TO ALLOW MAX SPEED	
START FEED - CROSS-SLIDE	S3 R2	1 " "	0 " "	0 " "	1 " "	0 " "	0 " "	1 " "	1 FLOW TO 3-4-5	1 FULL FLOW	1 FULL FLOW	1 FULL FLOW	1 FULL FLOW	COMBINATION OF V3-4-5 GIVE PROGRAMMED FEED	
STOP FEED 3" SLAVE CYLINDER - COMMENCE CREEP FEED	R1 R3	0 FLOW TO 0.5" SL	0 " "	1 RAM TO 0.5" SL	1 " "	0 " "	0 " "	1 " "	1 " "	1 " "	0 NO FLOW	0 NO FLOW	0 NO FLOW	FEED RESTRICTED TO V3 FOR CREEP FEED TO LIMIT OVER-RUN OF TOOL	
STOP FEED 0.5" SLAVE CYLINDER - STOP SPEED DWELL	S2 S1 C3	0 " "	0 " "	1 " "	0 AIR TO TANK	0 " "	0 " "	0 STOP	1 " "	0 NO FLOW	0 " "	0 " "	0 " "	RETURN OF RAM INTERLOCKED WITH C3. CROSS-SLIDE CENTRAL SIGNAL	
REVERSE RAM TRAVEL - 0.5" SLAVE CYLINDER TO R3 - QUICK RETURN AFTER DWELL	R3 C3	1 FLOW TO 3" SL	0 " "	0 3" SL TO RAM	0 " "	0 " "	0 " "	0 " "	0 FULL FLOW	1 FULL FLOW	1 PART FLOW	1 PART FLOW	0.5" SLAVE CYLINDER RETURNED		
REVERSE RAM TRAVEL - 3" SLAVE CYLINDER TO R2	R3 R2 R3	1 " "	0 " "	0 " "	0 " "	0 " "	0 " "	0 " "	0 " "	1 " "	1 " "	1 " "	1 " "	3" SLAVE CYLINDER RETURNED	
REVERSE RAM TRAVEL - CONTROLLED LENGTH RAM SIGNAL - FLUID TO TANK 3.	R3 R2 C3 C2	1 " "	1 RAM TO TANK	0 " "	0 " "	0 " "	0 " "	0 " "	0 " "	1 " "	1 " "	1 " "	1 " "	CYCLE WILL REPEAT - NEW PROGRAMME ON SIGNAL C1.	

FIG 11.

operation. Stop signal S1 has also activated V7 and the fluid is diverted into the 0.5 inch diameter slave cylinder, the 3 inch slave cylinder is now hydraulically locked. The programmed distance to travel of the 0.5 inch slave cylinder, gives stop signal S2; valve V3 is de-activated hydraulically locking the circuit; V13 is activated pressurising the fluid storage tank while the turret slide power cylinder vents to atmosphere. After a timed delay which allow the machine spindle to stop, and air pressure to build up in the fluid storage tank, valve 2 is de-activated and fluid from the tank flows through valves 1 and 2 to return the 0.5 inch slave cylinder. The exhaust fluid going through valves 7 and 8 into the turret slide power cylinder. On reaching position R3, valves 1 and 7 are activated and the fluid now flows into the 3 inch slave cylinder, exhaust fluid going into the turret slide power cylinder. When position R2 is reached, both slave cylinders have been returned; valve 6 is activated and the turret slide power cylinder is returned to C1, with fluid from the storage tank.

4.2.9. Schematic Arrangement of Fluidic, Pneumatic, and Hydraulic Circuits. Figure 18

From the sub-assembly circuit diagrams Figures 10 to 17, an arrangement diagram was prepared in order to co-ordinate signal pipes, and to enable such items as programme units to be incorporated. No truth table was considered necessary in this instance, as each sub-circuit drawing contained its relative table.

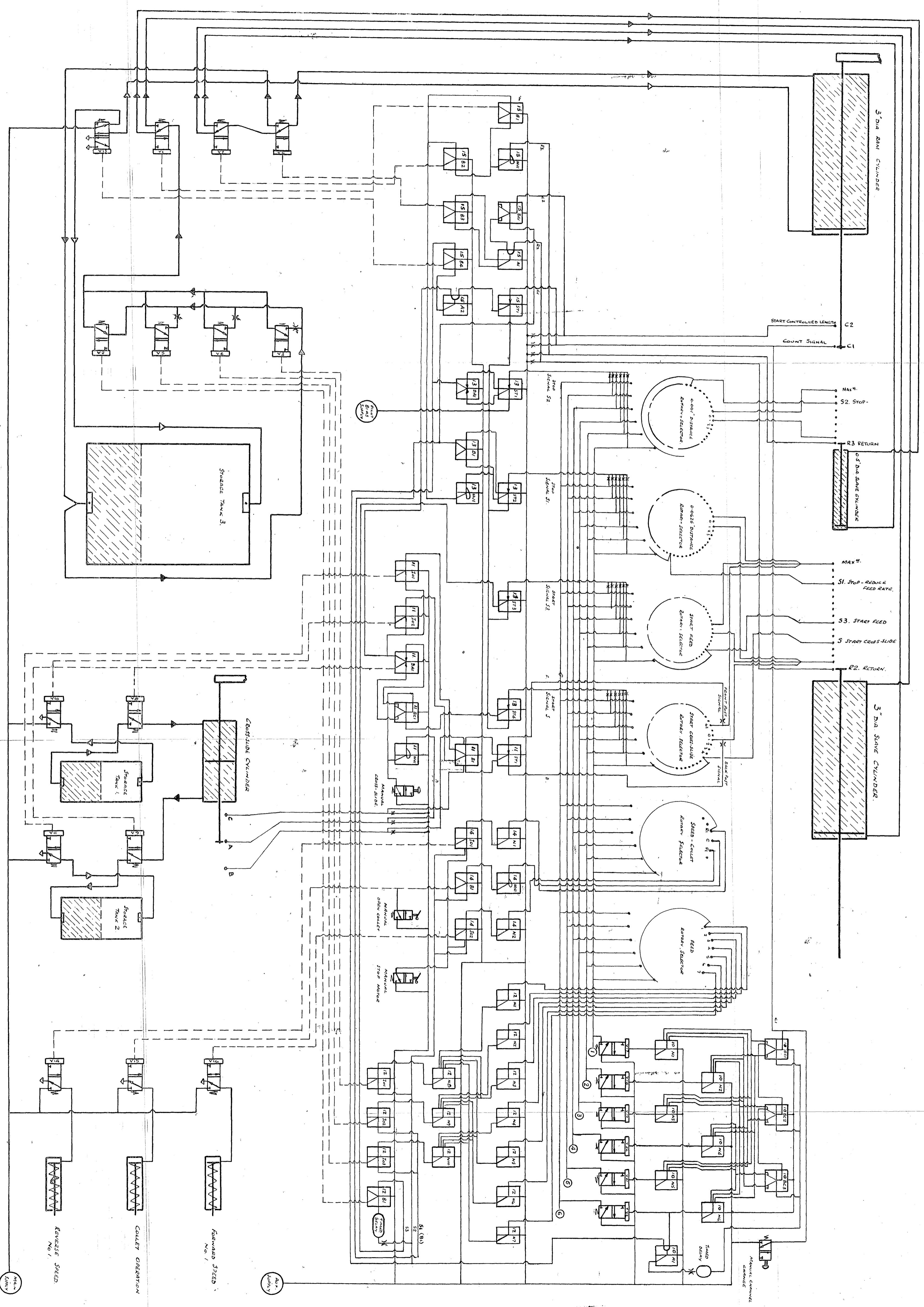

FIG. 18.

CHAPTER V

Design and Construction

The decision made in Chapter III regarding the design features and the circuits developed in Chapter IV provided the basis of each component or unit design and function. The control system is divided into two sections; the first comprising of the machine tool fitted with actuating cylinders to operate the machine slides etc., and the second, a control unit to command the machine to perform a desired series of events.

5.1. Machine Tool Operation

Operation of the machine tool is to be performed by standard pneumatic-hydraulic equipment, adapted where necessary by fitting special equipment. The following machine tool functions are to be controlled by a Control Cabinet, connected to the machine with data and power pipes.

5.1.1. Speed Selection

The machine tool is fitted with a multi-speed motor and friction clutch; a change in spindle speed can be obtained by selecting a particular electrical circuit. The rotary electrical contractor used for speed selection can be readily modified by fitting small single acting, spring return pneumatic cylinders to the contacts and removing the cam mechanism. Operation of the friction clutch can be achieved with a double acting pneumatic cylinder. To change the speed, the programme unit issues a data signal, and a command from the Control Cabinet activates the appropriate pneumatic cylinder to complete the electrical circuit.

5.1.2. Collet Operation

On a standard turret lathe, the collet chuck is operated with a hand lever, which if suitably modified, will fit the clevis of a double-acting pneumatic cylinder. The collet will open and close on receipt of a command signal initiated by the programme unit.

5.1.3. Turret Slide Motion

Movement of the turret slide is obtained by fitting a double-acting pneumatic-hydraulic cylinder, and sensing unit to the turret slide. This power cylinder is described and illustrated in Chapter 5.3.1; the direction and rate of traverse or feed being controlled by the Address System in the Control Cabinet.

5.1.4. Cross-slide Motion

The cross-slide motion is achieved in a similar manner; the double acting hydraulic cylinder and sensing unit, described and illustrated in Chapter 5.3.2, is fitted to the machine cross-slide.

5.2. Control Cabinet

Such systems as Logic, Address and Programme, are incorporated in the Control Cabinet, the assembly of which is described and illustrated in Chapter 5.5. The function, design and manufacture of the various components for these systems are as follows:-
(a detailed description can be found in Chapter 5.4. and 6.2.)

1. The 3 inch diameter slave cylinder and sensing unit, described in Chapter 5.4.1. repeats the travel of the turret slide power cylinder, (Figure 19) and provides programmed data signals to the Logic System for the engagement of turret slide feed, cross-slide etc.
2. The 0.5 inch diameter slave cylinder and sensing unit, described in Chapter 5.4.2., amplifies a limited travel of the turret slide power cylinder, and provides programmed data signals to the Logic System controlling turret slide travel.
3. Multi-channel programme selection units, for the various machine operations, described in Chapter 5.4.3. and 6.2.5. are connected to the slave cylinder sensing units and Logic System.
4. On the integrated circuit board described in Chapter 5.4.4., the Multi-channel Rotary Programme Selector units are mounted, connections for channel air supply, Logic system etc., are described in Chapters 5.4.5., 5.4.6., and 5.4.7. The Tape Programme Selector Units described in Chapter 6.2.5. are directly connected to the sensing units and Logic System
5. The Logic System consisting of mounting boards, air

supply manifolds and fluid logic devices, is assembled and fitted in the Control Cabinet with connections to the Programme Units, Sensing Units and Address System. The components and assembly are described and illustrated in Chapters 5.4.8., 5.4.9., 5.5.3., 5.5.4. and 6.4.

6. The Address System, comprising of spool, poppet and flow control valves, fluid storage tanks etc., is fitted in the Control Cabinet, where command signal pipes are connected to the Logic System. The manufactured components are described in Chapter 5.4.10., 5.4.11; the assembly in Chapters 5.5.1. and 5.5.2.

5.3. Machine Tool Power Cylinders

5.3.1. Turret Slide Power Cylinder Unit. Figure 19

The unit consists of a 3 inch diameter, 6 inch stroke, double acting non cushioned, double ended cylinder with a sensing unit fitted on one end; the other end is fitted onto the turret slide. Air pressure provides the power to overcome the cutting forces, and is applied on one side of the piston. Hydraulic fluid is used on the opposite side to prevent surge caused by the varying tool load conditions, and also, to actuate the slave cylinders. The sensing unit, fitted to the pneumatic side of the cylinder, consists of a circular probe fitted to the piston rod end, and a bracket with two sensing devices. The device marked C1, Figure 19, provides the count signal to the Logic System when the turret is indexing, and that the turret slide has returned to the zero position. The programme channel now changes to suit the newly presented turret face. The Device marked C2 Figure 19, signal "Logic" that the controlled length of travel; in this instance four inches, has commenced.

5.3.2. Cross-slide Power Cylinder Unit. Figure 20

The unit consists of a 1.5 inch diameter, 4 inch stroke, double acting non cushioned double ended hydraulically operated cylinder with a sensing unit fitted on one end; the other end is fitted onto the cross-slide. Linear control is not essential on this slide providing the tools are set at a definite radial distance from the machine centre line, and the slide travels a pre-set distance. The sensing head consists of two aluminium end plates, held relative to each other with two circular guide bars, which

TURRET SLIDE POWER CYLINDER.

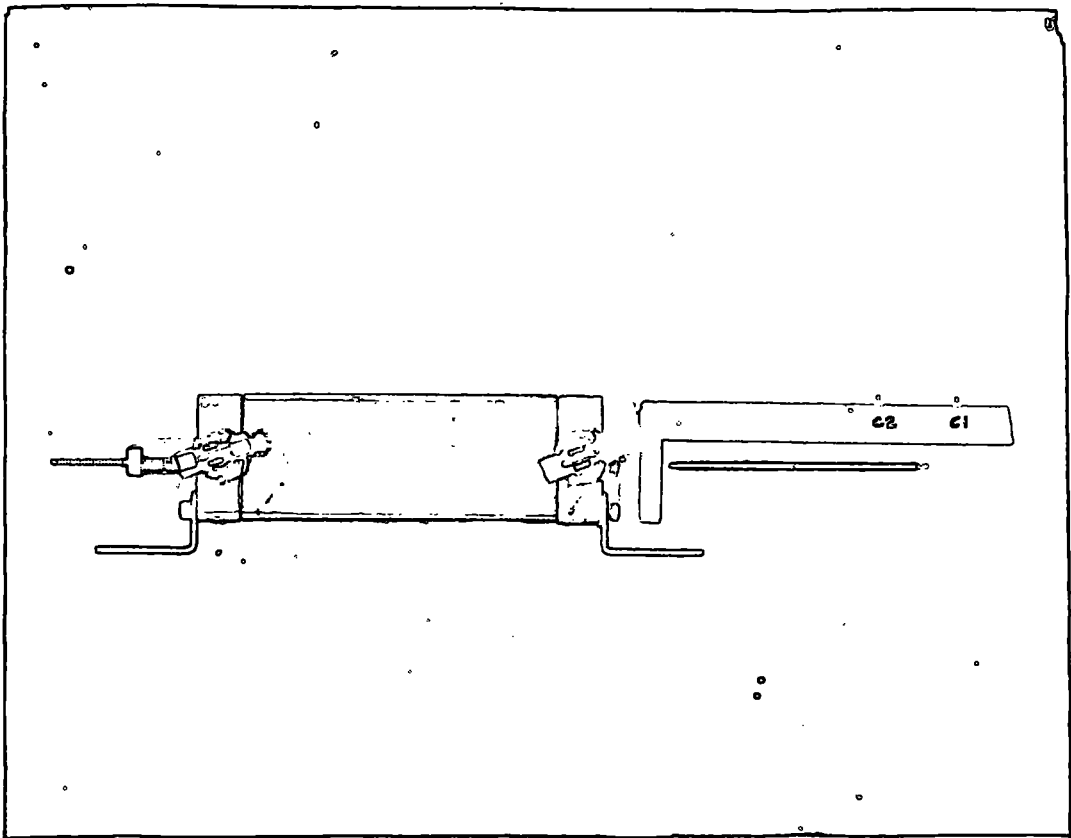

FIG 19.

CROSS-SLIDE POWER CYLINDER.

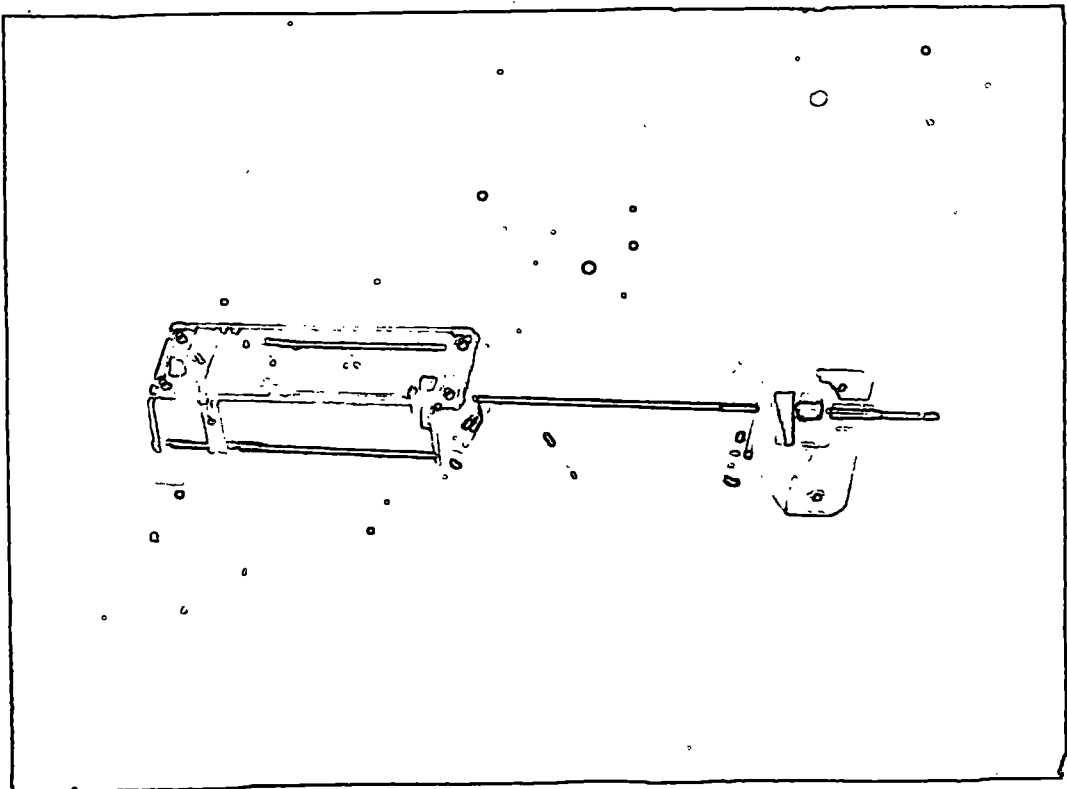

FIG. 20.

also control alignment of a sliding probe bar fitted with a spring loaded Tufnol wiper blade. The probe bar, fitted to the piston rod, slides along the guide bars; the wiper blade is in contact with a laminated perspex plate which has five sensing devices, each fitted with small bore aluminium tube connectors for the signal pipes. The sensing devices, marked B, B2, A, C and C2, Figure 20, control the cross-slide travel; B2 and C2 are extra devices for experimental purposes; A to B control the front tool post motion, A to C the rear tool post. When not in use, the cross-slide and tool posts are in a central position with the probe at position "A". A signal from the programme selector unit and the 3 inch diameter slave cylinder sensing unit switch fluidic devices which actuate diaphragm valves controlling hydraulic fluid to the cylinder. The piston and sensing head probe will travel from A to B or A to C, whichever is programmed at a pre-determined rate of travel. On reaching B or C, the tool will be at its correct radial position to produce the component diameter required. A signal from either sensing B or C will switch the fluidic devices and the cross-slide will quickly traverse back to the central position "A".

5.3.3. Power and Signal Pipes to the Machine Tool

The machine tool will now require four power and five signal pipes from the Control Cabinet; the turret slide having one Pneumatic power, one Hydraulic power and two Data Signal pipes. The cross-slide having two Hydraulic power and three Data Signal pipes; in addition to pipes required for speed and collet operation.

5.4. Description and Manufacture of Control Cabinet Units

5.4.1. 3 inch Diameter Slave Cylinder Unit. Figure 21

The unit consists of a 3 inch diameter, 4 inch stroke double acting double ended hydraulically operated cylinder with a sensing unit fitted at one end. Exhaust fluid from the turret slide power cylinder is supplied to the inlet port of this cylinder. As both of these cylinders have the same volume per unit length, the distance travelled by the piston is equivalent to that travelled by the turret slide cylinder piston. The rate of fluid flow from the exhaust port, is controlled by a selection of flow control valves which enable a programmed rate of feed for the turret slide to be obtained. The sensing unit, fitted to the screwed nose of the cylinder, consists of one intermediate and two aluminium end

3 IN. DIAMETER SLAVE CYLINDER AND SENSING UNIT.

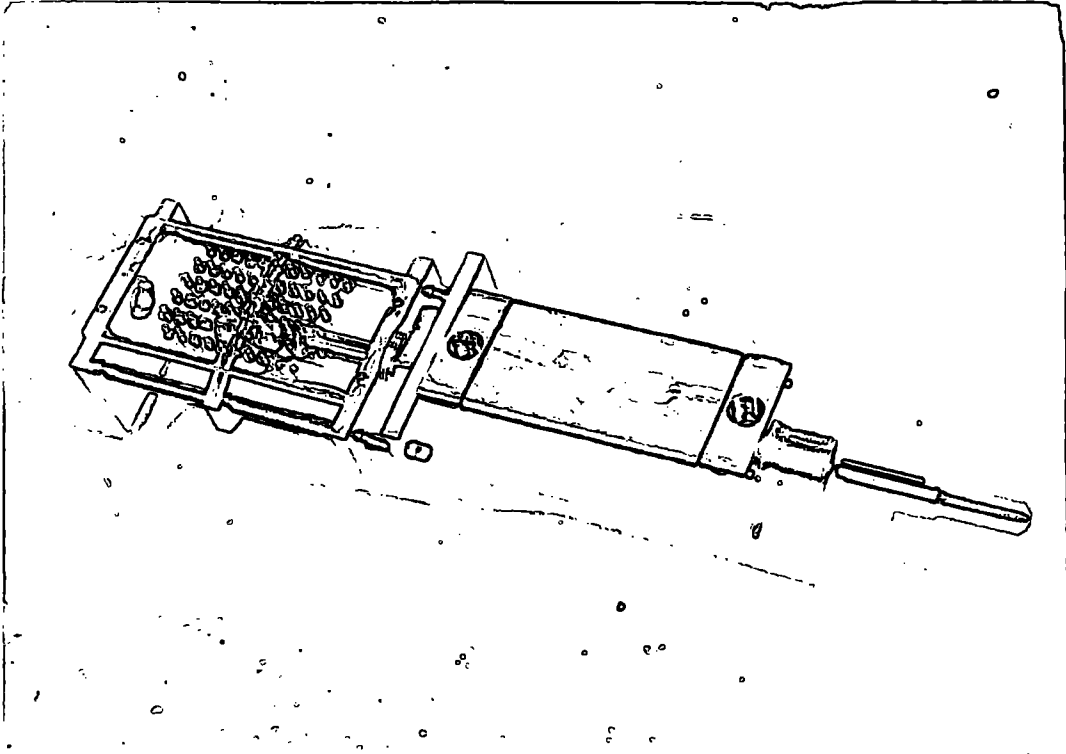

FIG. 21.

0.5 IN. DIAMETER SLAVE CYLINDER AND SENSING UNIT.

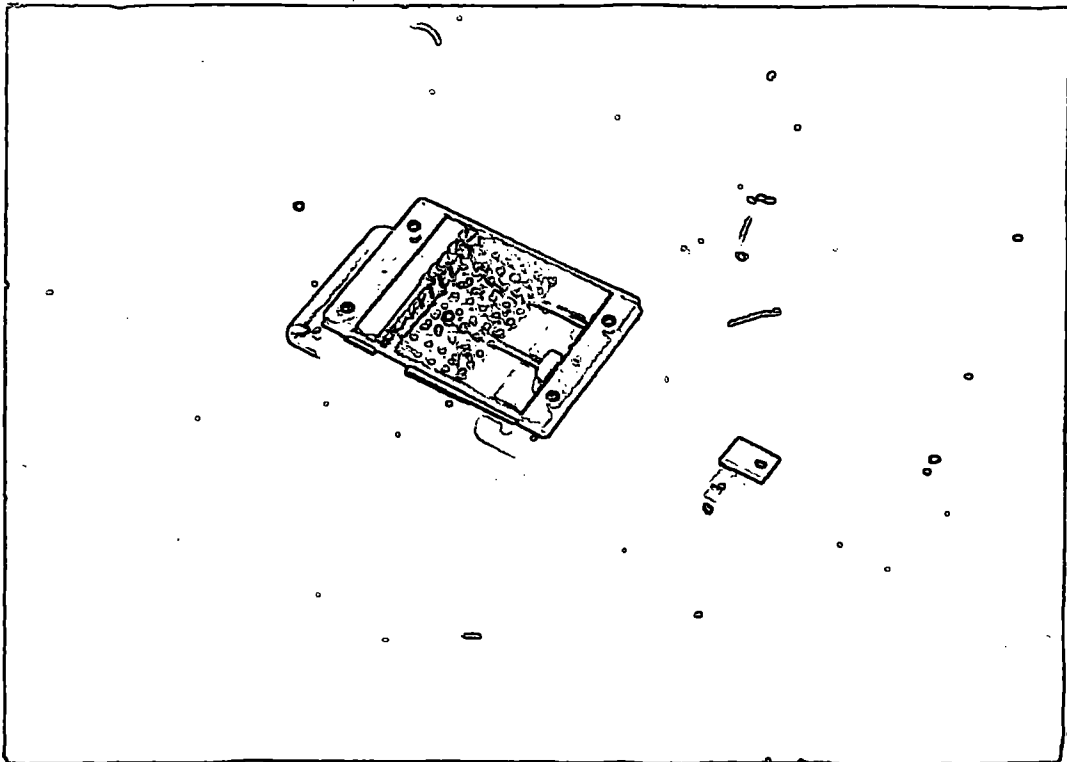

FIG. 22.

plates held relative to each other by two circular guide bars. These bars also control alignment of the travelling probe and prevent the piston rod rotating. Fitted between the end and intermediate aluminium plates, is the sensing device plate, manufactured from laminated perspex. Each sensing device has an orifice of 0.032 inches diameter, spaced at 0.0625 inch longitudinal centres and 0.5 inch cross centres, giving adequate space for the signal pipes which fit onto the small bore aluminium tubing in the top of each orifice. The aluminium probe bar fitted to the piston rod end, has brass bushes and slides along the guide bars. An 0.04 inch wide spring loaded Tufnol wiper bar in the probe is kept in contact with the sensing head plate, and as it covers the selected orifice and prevents air escaping, a back pressure pulse will actuate fluidic devices.

5.4.2. 0.5 inch Diameter Slave Cylinder Unit. Figure 22

The unit consists of a 0.5 inch diameter, 2 inch stroke double acting single ended hydraulic cylinder with a sensing unit fitted. Exhaust fluid from the turret slide power cylinder, is switched from the 3 inch slave cylinder, when it has travelled the programmed 0.0625 inch distance, to the inlet port of this cylinder. The volumetric ratio between the two slave cylinders is 31.3 to 1, each 0.001 inch movement of the turret slide power cylinder will move the 0.5 inch diameter slave cylinder 0.0313 inches. When the exhaust fluid from the turret slide power cylinder is switched to the small slave cylinder, the large slave cylinder is hydraulically locked. Exhaust fluid from the slave cylinders has been flowing through the programmed number of flow control valves to give the desired rate of turret slide feed. On switching to the 0.5 inch slave cylinder, the fluid now passes through a reduced fixed flow control valve, before returning to the hydraulic fluid storage tank. A reduced turret slide feed, irrespective of programmed feed, is now in operation preventing tool over-run and variation in component length, which would occur owing to turret slide inertia and the various rates of feed. The sensing unit, having 64 sensing devices, is the same basic design as that fitted to the 3 inch diameter slave cylinder, but of lighter construction and has the sensing devices at 0.0313 inch longitudinal centres. When the programmed sensing device is activated by the probe, fluidic devices operate various diaphragm valves which stop the feed and air supply to the turret slide power cylinder. The hydraulic fluid storage tank is pressurised to return the fluid into the various cylinders, by-passing the feed flow control valves and returning the 0.5 and

3 inch slave cylinders to zero. Exhaust fluid from the opposite side of these cylinders returns the turret slide power cylinder to zero, any loss owing to seepage being made up from the fluid storage tank. The programme change now takes place and the next cycle of events commences.

5.4.3. Multi-channel Rotary Programme Unit. Figures 23 and 24

This is the first type of programme unit developed; they are approximately 2.625 inches maximum diameter, reducing to 1.625 inches diameter and 2.375 inches high. They consist of a number of dials, each slightly smaller in diameter than its predecessor, have a knurled edge, a calibrated scale in the appropriate units and they are fitted with a perspex cursor to facilitate the selection of the programme. A spigot on the unit base, locates it in the integrated circuit board described in Chapter 5.4.4. When a channel is activated, the signal passes through the various holes and circular grooves in the Channel dials until the programmed dial is reached. A radial hole from the circular groove in the dial has been aligned with a signal groove in the core when the unit was programmed; this allows the signal to pass back through the unit baseplate to the relative sensing or fluidic device. The units were made in an aluminium alloy for ease of production, but the softness of the material proved to be a handicap; the slightest knock during handling bruised the component, impairing the efficiency of the sealing surfaces. A gas hardening alloy steel, would not only prevent this, but would allow positive location of each channel dial relative to the signal groove in the core, by means of a spring loaded ball locating in the core signal groove. Components for the unit are shown in Figures 25 and 26, they are:-

- | | |
|---------------|--|
| 1. Item A | Baseplate |
| 2. Item B | Core |
| 3. Item C - H | Channel dials |
| 4. Item I | Plastic sealing disc |
| 5. Item J | Spring steel pressure plate |
| 6. Item K | Stainless steel friction pad angle bracket |
| 7. Item L | Spring steel dial pressure spring |
| 8. Item M | Aluminium cap |
| 9. Item N | Perspex cursor |

The aluminium baseplate, item A, has six input signal holes, one for each channel; sixty four equally spaced output signal holes

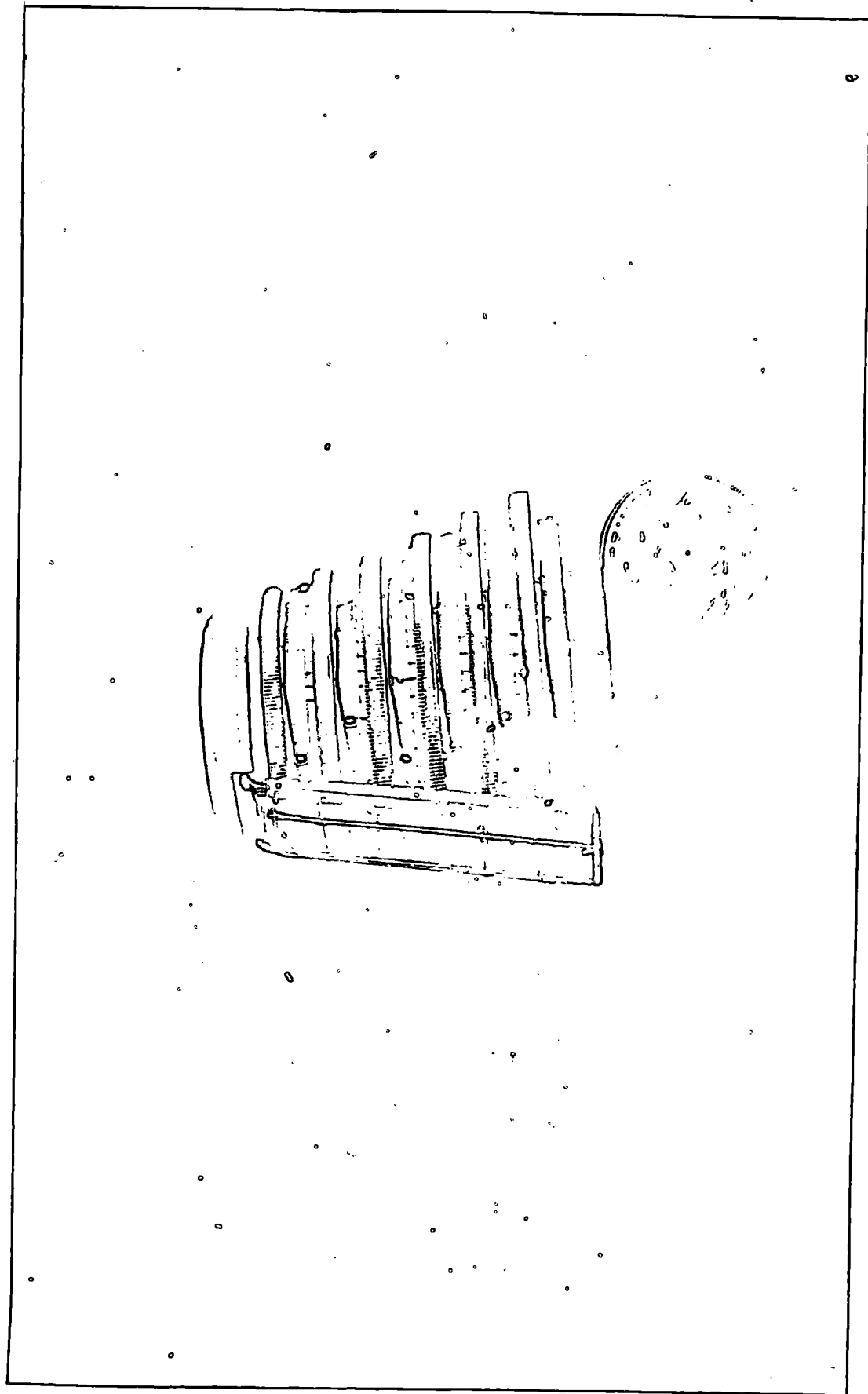

ROTARY PROGRAMME UNIT.

FIG. 23.

ROTARY PROGRAMME SELECTOR SWITCH.

FIG. 24

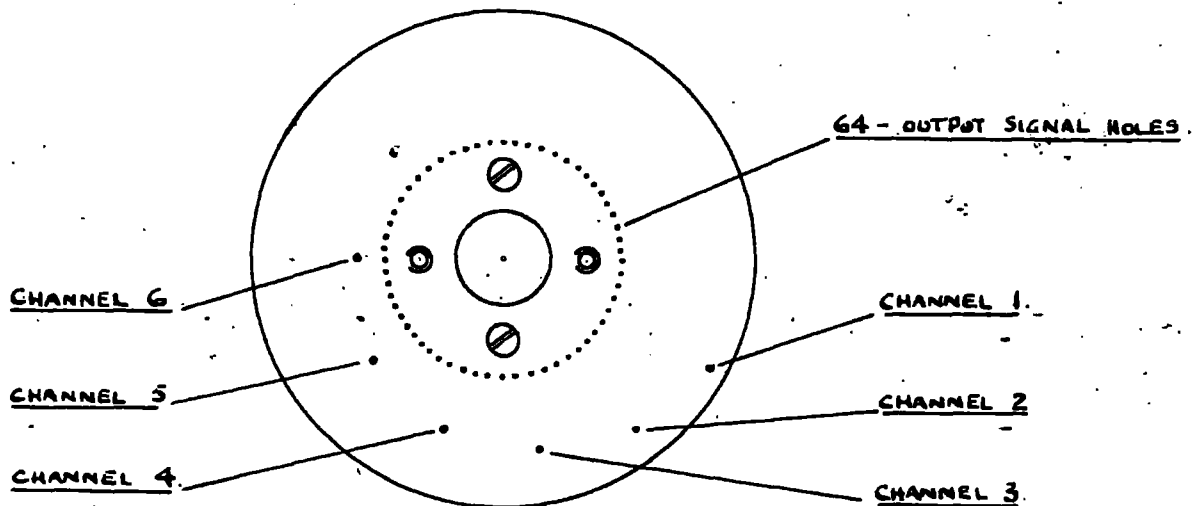
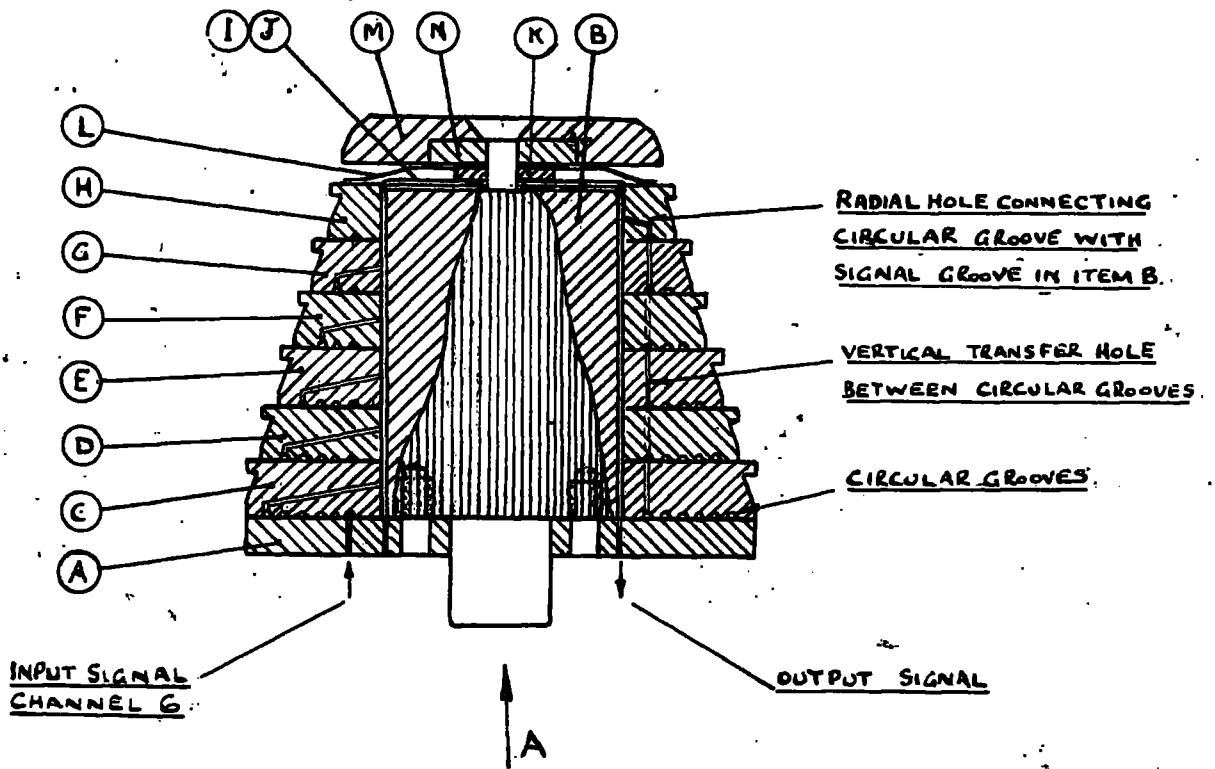

VIEW OF SWITCH BASE. (DIRECTION OF ARROW 'A')

0.032 inches diameter on a 1.170 inch pitch circle diameter; an 0.5 inch diameter bore; two 0.125 inch diameter mounting screw holes and two 0.093 inch diameter countersunk screw holes to fasten the core in position.

The 1.250 inch diameter aluminium core, item B, has sixty four equally spaced signal grooves 0.03 inches wide, 0.04 inches deep, which line up with the signal holes in item A. One end is reduced to 0.5 inches in diameter, locating item A and the unit, in the Integrated circuit Board described in Chapter 5.4.4; the other end is drilled and tapped for the cap screw.

The six aluminium channel dials, items C to H rotating on the core, item B, have lapped joint faces and bores to give a mechanical air seal. In the bottom face of each dial are circular grooves, six in item C, five in item D and so on, item H having one. From the 1.25 inch diameter bore a radial hole is drilled to the outer circular groove, transferring any signal to the core grooves in item B. The remaining grooves are connected to other dial radial grooves by vertical ^{holes} 0.032 inches diameter. An input signal for dial H will pass through dials C to G, and then through the radial hole in H to the core groove. When the baseplate A, core B and dials C to H are assembled, the signal grooves in core B are blanked off with the sealing disc I and pressure plate J; this item now projects slightly above the top channel dial, item H. The friction pad bracket, item K, is fitted on the top of pressure plate J, then, the dial pressure spring, item L, and finally the cursor, item N and the cap, item M. The cap screw is inserted through these items, finger tightened, the cursor and friction pad bracket are adjusted to their correct positions and the cap screw is tightened, locking the items in position. As the cap is tightened down, the dial pressure spring is compressed, applying pressure on the lapped surfaces of the dials to provide a mechanical seal.

Standard machine tools were used to manufacture the various items; the number of small holes and their positional accuracy dictated the manufacture of some jigs and special equipment. Figure 27 illustrates some of the special equipment which saved a great deal of time:-

1. Figure 27A. A plate drill jig for the sixty four 0.03 inch diameter holes on a 1.17 inch pitch circle diameter, two 0.125, two 0.093 and six 0.03 inch diameter input signal holes. This jig was used on the baseplate, item A and the Integrated Circuit

ROTARY PROGRAMME UNIT COMPONENTS.

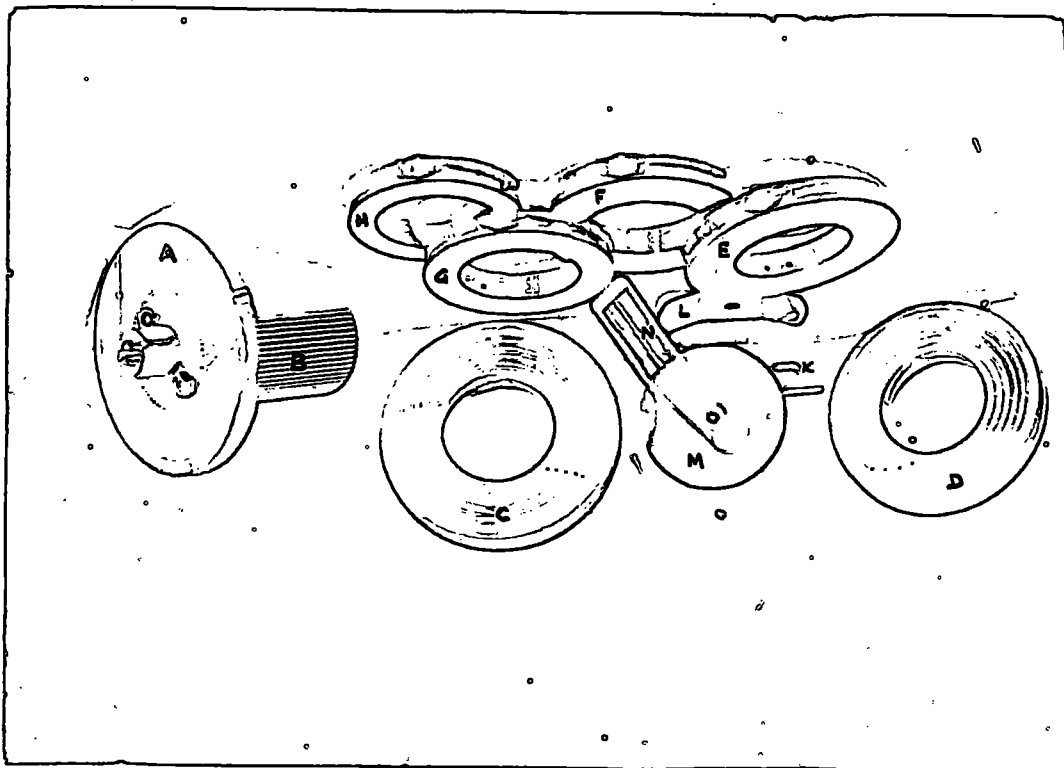

FIG. 25.

ROTARY PROGRAMME UNIT COMPONENTS.

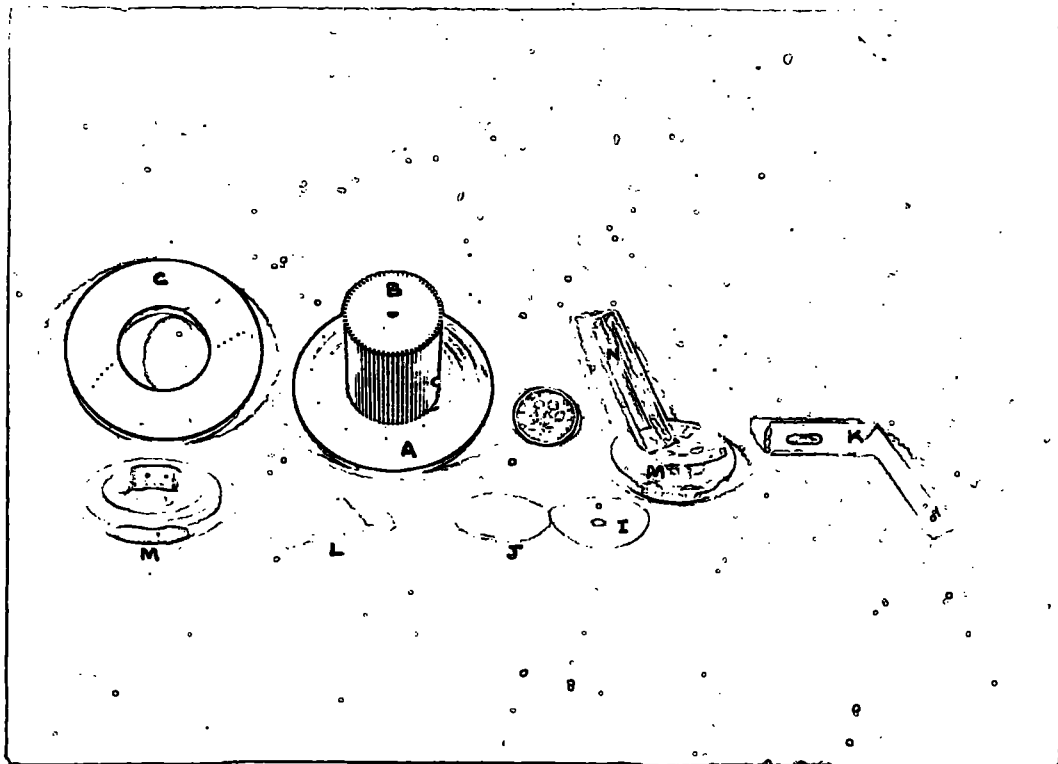

FIG. 26.

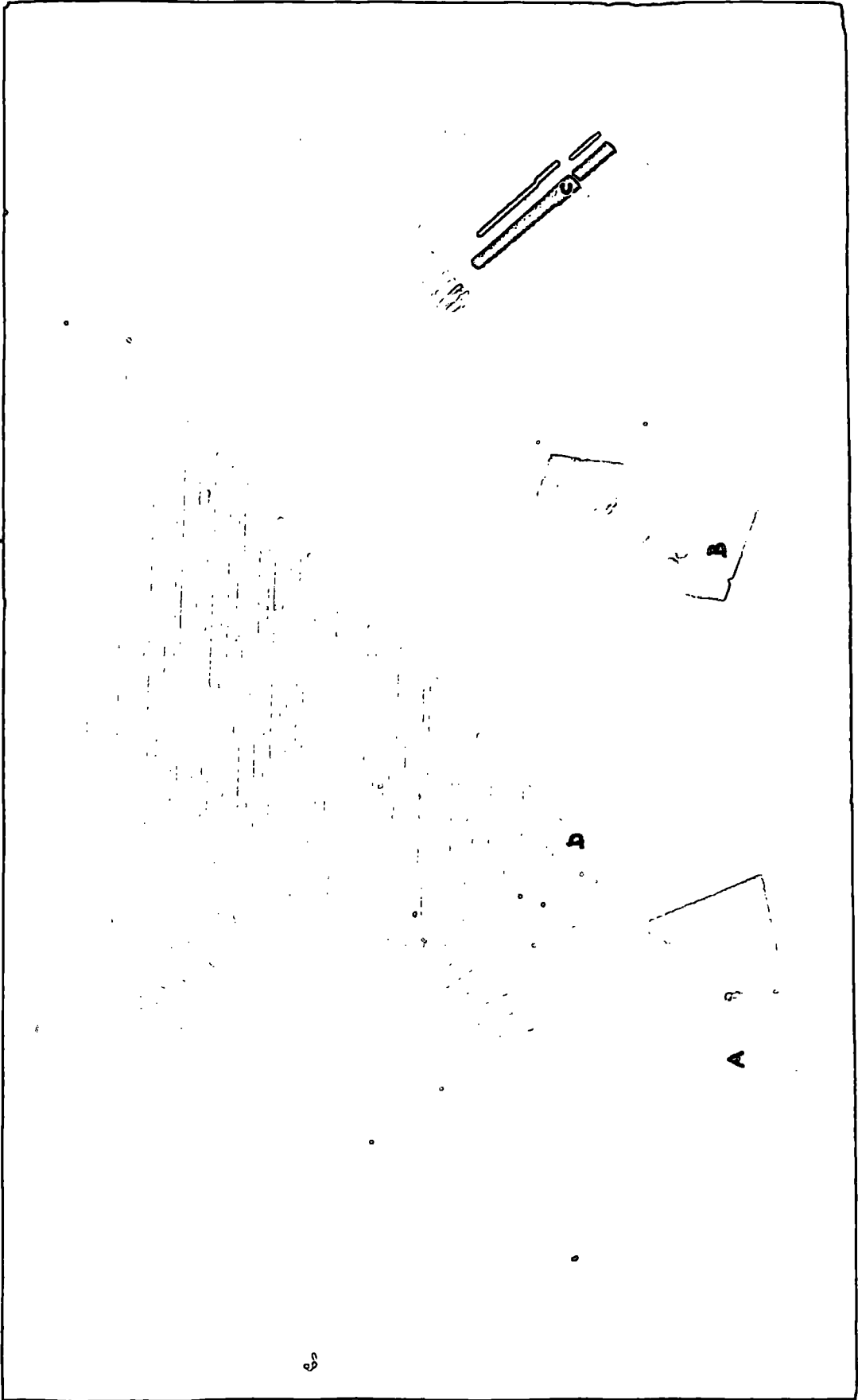

FIG. 27.

SPECIAL TOOLS.

Board sheets 1 and 2.

2. Figure 27B. An angle drill jig for the radial hole in channel dials, C Items C to H.
3. Figure 27C. An engraving mandril for the channel dials item C to H. A peg is fitted in the radial hole of each dial and located in the mandril groove, the index ratchet wheel fitted and tightened down with a nut. The assembly is then placed between centres for engraving.
4. Figure 27D. A 4 to 1 engraving template for the Integrated Circuit Board.

5.4.4. Integrated Circuit Board for the Rotary Programme Unit

Figures 28 and 29 .

The close centres of the sixty four 0.032 inch diameter holes in the Rotary Programme Unit baseplate will not permit the fitting of signal pipes. Increasing the hole centres would make the unit twice its size and as some method of mounting the units is required an integrated circuit board was produced. Figure 28 shows the front face of the multi-plate integrated circuit board, which measures twenty four by eight by five eighths inches, accommodating six Rotary Programme units at 3.75 inch centres. The white lines on the illustration are signal grooves, 0.03 inches wide by 0.04 inches deep; vertical lines marked "A" are for the input supply from the Channel Selection Fluidic circuit to the channel dials. Horizontal lines "B" are common back pressure signal grooves connected to the Selector Switchboard Fluidic circuit; vertical pattern "C", a fan-out from the sixty four 0.032 inch diameter holes to facilitate signal pipe fitting. The horizontal pattern "D" connects three Programme units which have a common connection to the 3 inch Slave Cylinder Sensing Unit. A back view of the board, Figure 29, shows the small bore aluminium output signal tubes onto which pipes are fitted. At position 1, the 0.001 inch distance Programme unit is fitted and the output signal pipes are connected to the 0.5 inch Slave Cylinder Sensing Unit. At position 2 the 0.0625 inch distance programme unit is fitted, at position 3, the Commence Feed Unit, and at position 4, the Engagement of cross-slide motion relative to Turret Slide Motion Unit is fitted. The change in groove pattern at position 4 connects the odd number signal grooves for the cross-slide front toolpost operation and the even number signal grooves for the rear toolpost operation. At position 5 the Feed Selection Programme Unit, and at position 6, the Speed and Collet Operation Programme Unit is fitted, the number of selections required from

INTEGRATED CIRCUIT BOARD.

FIG. 28.

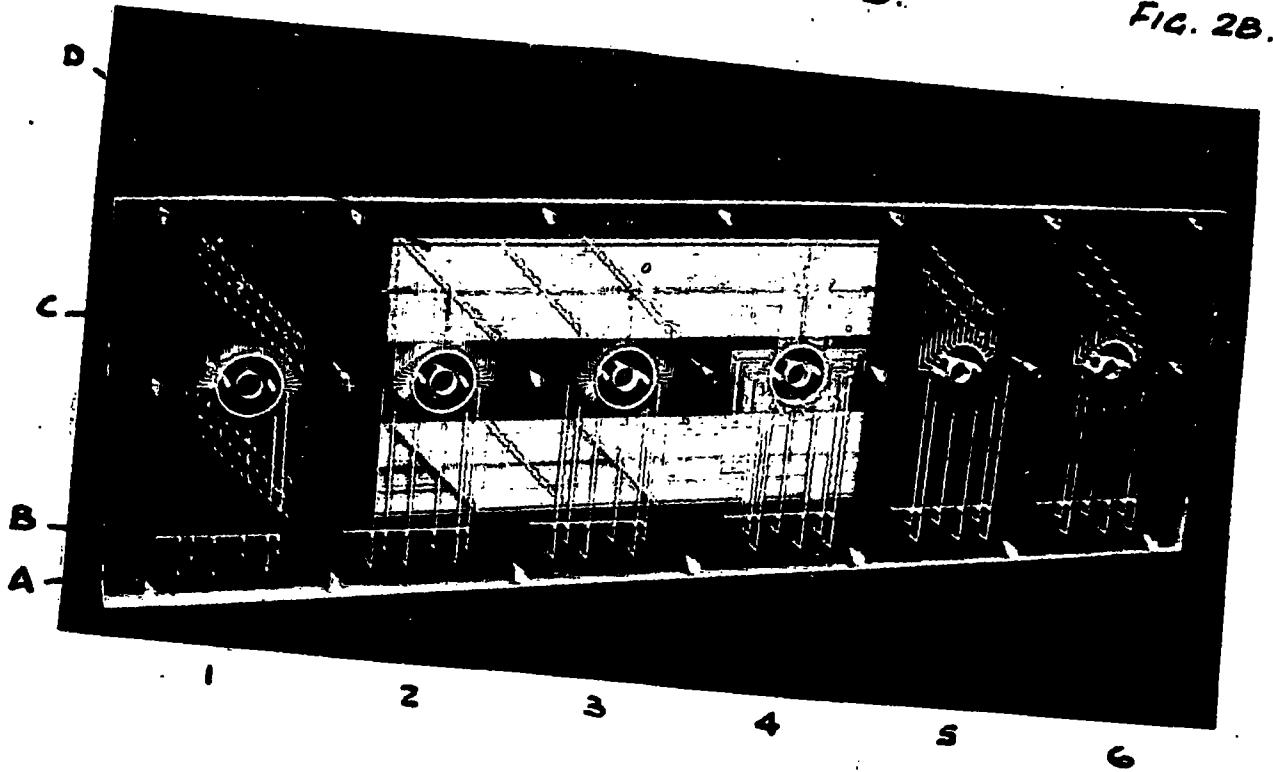

INTEGRATED CIRCUIT BOARD

FIG 29.

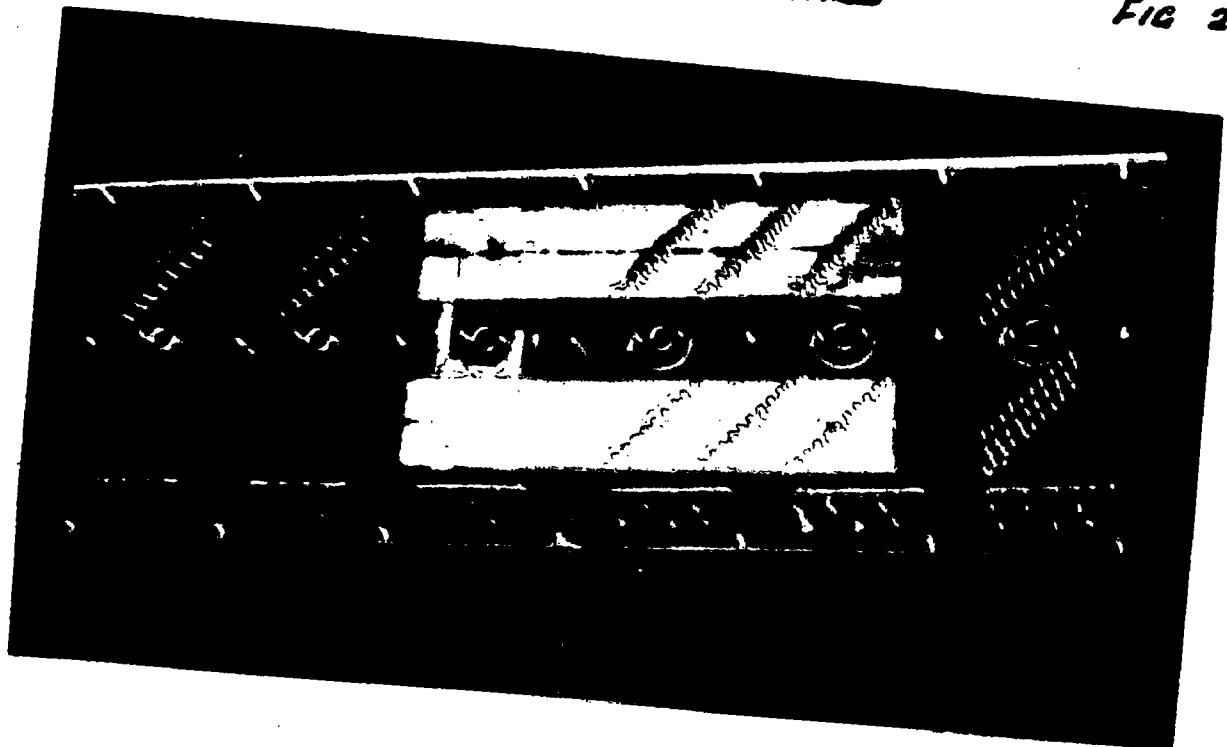

the last two Programme Units are limited, and only a section of the fan-out patten C is cut in the plate; output signal pipes are connected to the relative fluidic devices.

The integrated board was constructed from five 0.125 inch thick perspex sheets, as shown in Figure 30, each cut approximately to size on a bandsaw, clamped together, and drilled to suit the 3 BA, counter-sunk head clamping screws. After the removal of the clamps, the joint faces were cleaned, the clamping screws fitted and the edges machined parallel and square to each other for setting and reference purposes. Plates 1, 2 and 3 were fastened together and the 0.5 inch diameter location holes at 3.750 inch centres, drilled and reamed for location of the Programme Units. Plate 3 was then removed, the drill template Figure 27A was located in the 0.5 inch diameter hole, and the 0.032 and 0.125 inch diameter holes were drilled. On an engraving machine grooves "A" were cut from the 0.032 inch input signal holes in plate 1, and patten C on plate 2 with the aid of a 4 - 1 ratio template, figure 27D. Grooves D, patterns E and F on plates 3, 2 and 4 respectively, were produced by a combination of table traverses. Input signal holes were drilled by fitting plates 1 and 2 together, then drilling through plate 2 into the engraved grooves. Plate 2 was then used as a drill template for plates 3, 4 and 5; the holes in plate 5 were increased in diameter, and made a press fit for the small bore aluminium tube on which the signal pipes fit. A similar technique was used for the output signal holes in plates 3, 4 and 5; the back pressure signal grooves B, in plate 4 were engraved after the holes were drilled.

The drilling and engraving operations had deformed the surfaces and produced burrs which would prevent air tight faces being obtained, in addition to which, cuttings had fused to the sides of the grooves and holes. Joint faces were deburred, lapped flat, grooves and holes cleaned and air blasted. The aluminium tubes were fitted in plate 5, and the plates were assembled and tested for blocked airways with a pressure of 30 inches water gauge. When the pressure was increased to 60 inches water gauge, the plates deformed causing a considerable drop in output signal pressure, some signal transfer between adjoining grooves and a circuit resistance higher than estimated. These problems could be reduced or overcome by bonding the plates together, and increasing the size of signal holes and grooves. Tests carried out, on the equipment available, with various bonding agents, indicated that a perspex cement diluted with trichlorethylene gave

satisfactory results and a partial blockage of a groove could be flushed clean. Plates 1 and 2 were sprayed with diluted cement, located and pressed together, then plates 3, 4 and 5 were assembled together; this order of assembly provided maximum accessibility to clear any holes which were blocked with cement. When removed from the press, excess cement on the joint faces had blocked several grooves and holes. The grooves and holes were cleaned out with some difficulty. During the bonding tests, Acetone had been used, but rapid evaporation made it difficult to maintain a thin film over a relatively large area in order to soften the perspex joint faces. This, together with fumes and cracks developing from mechined grooves, made the use of a diluted cement attractive, but in view of the blockages which had occurred, it was decided to use Acetone for the final joint between plates 2 and 3. This joint face has a considerable number of inaccessible holes, which if blocked, could only be cleared chemically, - a slow process in this instance. The joint faces were sprayed with Acetone until soft, located together and a clamping pressure applied until set, any surplus Acetone in grooves or holes evaporated and no blockages occurred.

Preliminary tests on some circuits confirmed that the modifications to the grooves and holes had improved the over-all efficiency, but the surplus bonding cement in some grooves restricted the flow of air and reduced output signal pressures to a few inches of water gauge. The joint face between plates 2 and 3, bonded with Acetone, was not satisfactory; the bond between some signal grooves was not air tight and leakage occurred dissipating a signal over several outlets. To overcome this fault it was necessary to cut the board into sections as shown in Figure 31 - joint faces were split with some damage that was rectified later, faults were corrected and the plates rebonded. The reduced size of plates made the re-bonding operation quite simple when compared with the large plates, and with the faults corrected, a circuit efficiency between 90% and 95% was obtained.

The use of existing commercial techniques, such a photo sensitive glass or plastic would have simplified the production of this unit, but in this instance was prohibited by cost.

5.4.5. Junction and Cross-slide Manifolds. Figure 32

Modifications to the Integrated Circuit Board damaged the connecting grooves "D", which connect the programme units at positions 2, 3 and 4, to the 3 inch Slave Cylinder Sensing Unit. Similarly, an

INTEGRATED CIRCUIT BOARD COMPONENTS.



FIG. 30.

MODIFIED INTEGRATED CIRCUIT BOARD.



FIG. 31.

alternative for the damaged patterns E and F at position 4, controlling selection of either front or rear toolpost on the cross-slide was required. Inter-connection of positions 2, 3 and 4 was achieved with the aluminium junction manifold Figure 32A; signal pipes from each programme unit position fit into the holes, which have a common outlet connected to the sensing unit. Patterns E and F were replaced with the aluminium manifold Figure 32B; odd numbers from the programme unit, are fitted into the holes at one side of the manifold, and even numbers the opposite side. A restricted signal hole from each odd numbered pipe is connected to a common outlet signal hole marked "R"; the pipe from "R" connected to control C2 of the Schmitt Trigger ST1 Figure 11. A similar arrangement for even numbers with the outlet marked "F" is connected to control C1 of the Schmitt Trigger. The selection of any odd number on the Rotary Programme unit provides a signal to the cross-slide fluidic devices, programming the circuit for rear toolpost operation; an even number programmes the circuit for front toolpost operation. Both manifolds are mounted on brackets which fit on the back of the Integrated Circuit Board.

5.4.6. Back Pressure Signal Manifold. Figure 33A

During the tests on the Integrated Circuit Board, a variation in the back pressure signal strength had been observed and attributed to the flow resistance in grooves, pipes and the dimensional variation of the fixed restrictors in the "Board". As the back pressure signal is also proportional to the supply pressure, the variation between signals from each Programme Unit could be considerable, but controllable by using a variable bias signal pressure to the Schmitt Triggers incorporated in each fluidic circuit. The use of fixed restrictors inserted in the "Board" was not sufficiently versatile for experimental purposes, and were replaced by the manifold, Figure 33A. The manifolds, manufactured in aluminium, have six inlet pipe holes with screw adjustment to vary the restriction, enabling the output of each inlet to be set and balanced with other Programme Units. The common output, connected to the appropriate Schmitt Trigger with a bias signal supply common with other circuits; the bias setting the Schmitt Trigger to operate at a pre-determined back pressure signal strength.

5.4.7. Channel Supply Manifold. Figure 33B

It had been intended to connect the output of the Channel Selection Fluidic circuit, Figure 10, to the inlets of the Programme Units. Unfortunately, the output flow from the "NCR" gates was

JUNCTION AND CROSS-SLIDE MANIFOLDS.

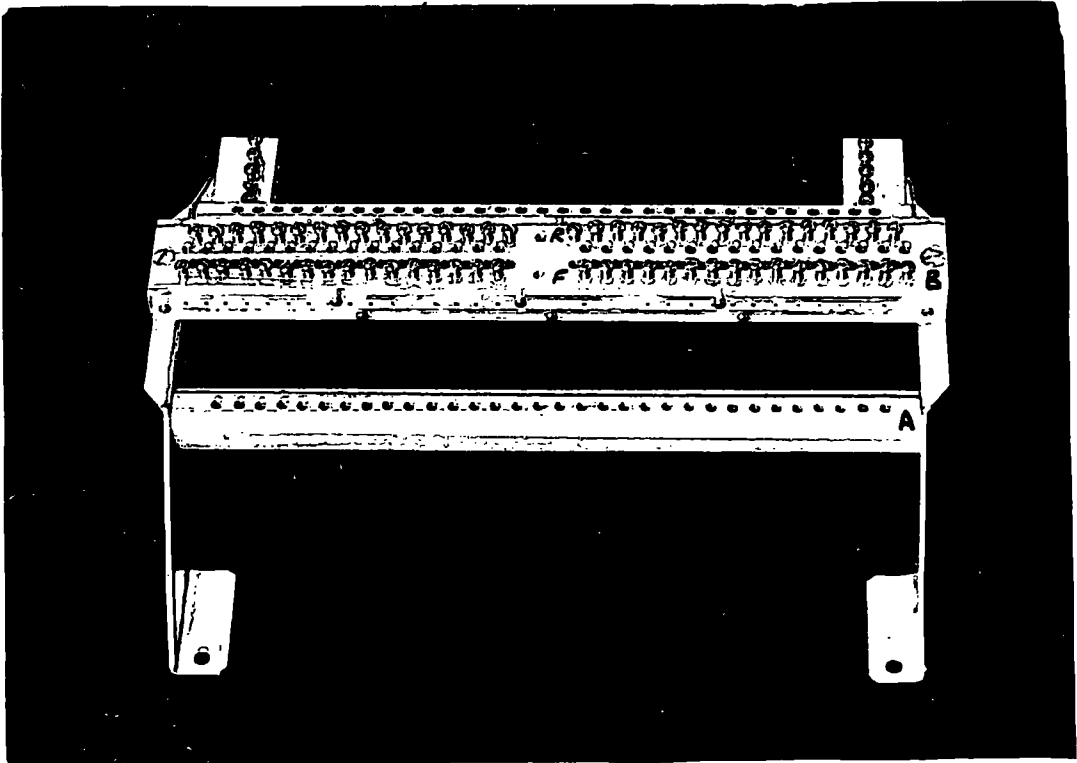

FIG. 32.

BACK PRESSURE SIGNAL - CHANNEL SUPPLY
AND FLUIDIC UNIT SUPPLY MANIFOLDS.

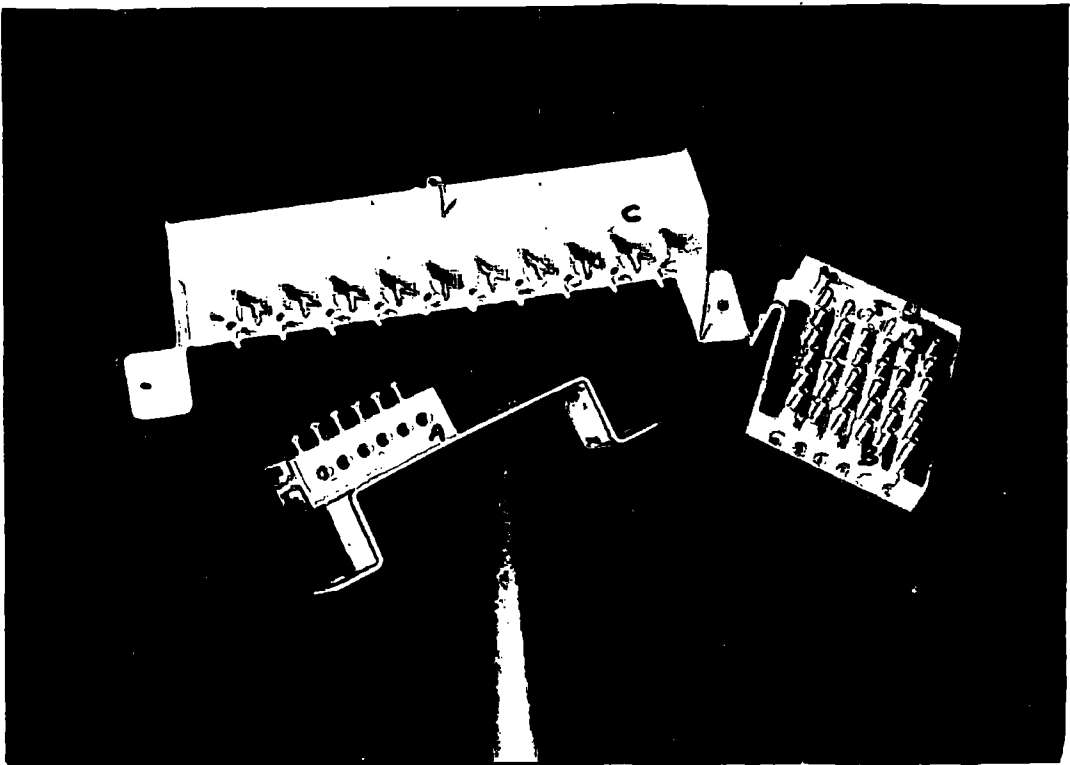

FIG. 33.

insufficient to meet the requirements of the six units. Each channel output signal was utilised to activate a three port diaphragm valve, which supplied air from the auxiliary pressure supply, in sufficient quantity, to the perspex Channel Supply Manifold, Figure 33B. From each of the six channel supply holes, small bore aluminium tubes were fitted and connected to Programme Units. An additional tube, connected to an indicator on the Control Cabinet Panel, informs the Operator which Channel circuit has been activated.

5.4.8. Fluidic Unit Supply Manifold. Figure 33C

The Fluidic Supply Manifolds utilised, are similar in construction to that illustrated in Figure 33C; their function is not only to provide sufficient "1/16" and "3/16" internal diameter tube outlets to supply the fluidic board, but to act as a reservoir, and reduce any fluctuation in air supply to the logic devices, which can occur when several cylinders are activated simultaneously. The manifolds were manufactured from one inch square rolled tube; holes were drilled for the "1/16" and "3/16" inch diameter tube connections and after de-burring, the tube connections were soldered in position. The end plates, which also act as mounting feet, were then soldered on the tube ends, the unit was cleaned, pressure tested and then painted.

5.4.9. Fluidic Unit Mounting Board. Figure 34

The dimensional proportions of fluidic devices are arranged in modules; a Bistable, Nor, And, and Digital Amplifier are classed as one module; a Schmitt Trigger, one horizontal by two vertical, as two; a Multivibrator, three horizontal by one vertical, as three and a Binary Counter, two horizontal by two vertical as four. A pattern of holes to suit the connections and fixing holes of a "one module device", if repeated in sufficient numbers, would accommodate any logic device. Several Mounting Boards, similar to Figure 34, but of varying capacity, were required; it was decided to manufacture one "Board" in 12 s.w.g. plate and use it as a drill jig. The required boards of varying sizes were cut from 22 s.w.g. plate, clamped to the jig plate, drilled, de-burred and painted ready for assembly.

5.4.10. Hydraulic Fluid Storage Tank. Figure 35

Two sizes of storage tanks, similar in design to Figure 35 were produced; one with sufficient capacity for the turret slide and related cylinders, and two smaller units for the cross-slide cylinder. The principle reason for using a fluid is to obtain an accurate fluid

TYPICAL FLUIDIC UNIT MOUNTING BOARD

FIG 34

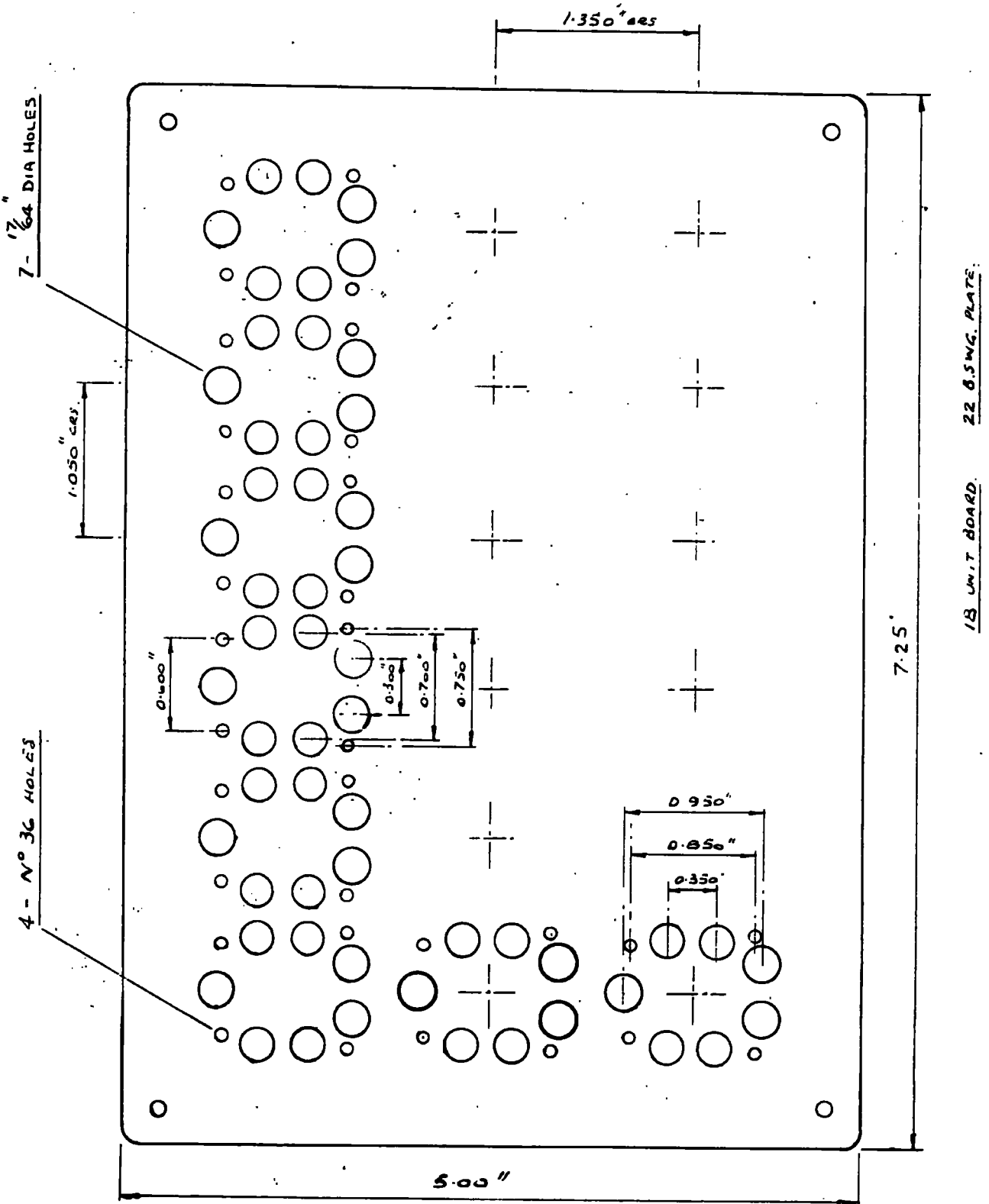

HYDRAULIC FLUID STORAGE TANK.

FIG. 35.

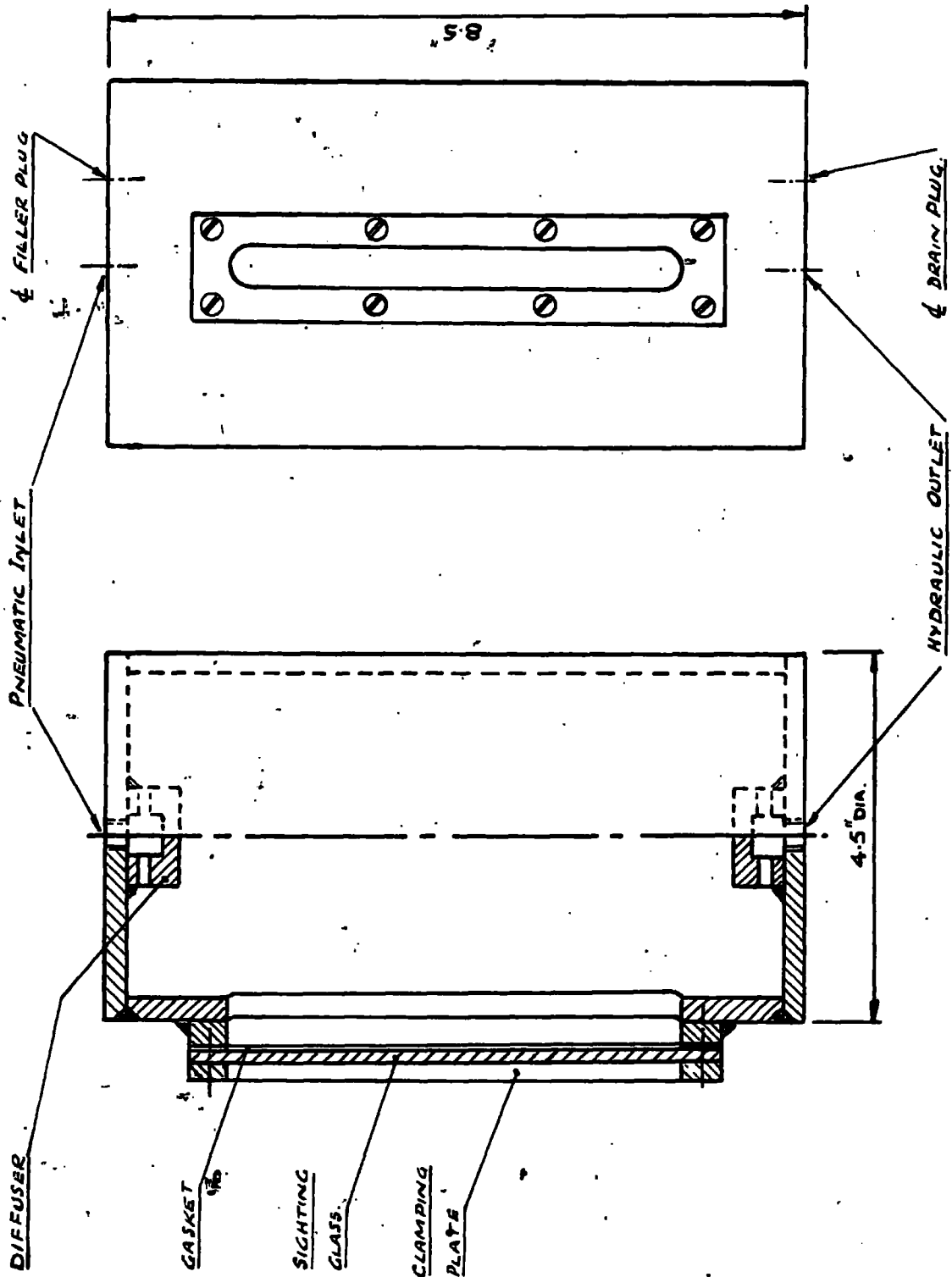

flow control, and motion of the cylinder without surging, which usually occurs when varying loads are applied to pneumatic cylinders. The Hydraulic Fluid Storage Tanks were manufactured from thin wall tube and were fitted with a fluid level gauge. The end caps were drilled and tapped for inlet, exhaust, drain and filling pipes and plugs, before the diffuser bosses were welded into position over the inlet-outlet holes. The diffuser bosses are essential, as they prevent the returning fluid being squirted up the air inlet pipe, to find its way into the valve exhausting to the atmosphere. After the end caps and tubes were cleaned, the caps were welded in position, mounting brackets fitted and the tanks pressure tested and painted.

5.4.11. Control Cabinet Frame and Panels. Figure 36

The overall size of the cabinet was controlled by the slave cylinders, sensing units, and the number of valves, with the instrument panel faces angled for convenience of the operator. The frame, constructed from 24 S.W.G. plate cut into two inch wide strips, was folded to form an angle section, then cut to length for the various members. Fixing holes for the units and valves were punched in the appropriate members, which were then spot welded together. The top instrument panel was fabricated from a small section folded angle and holes were punched to suit the fixing screws of the Integrated Circuit Board that fits in this frame. The lower panel, folded to shape from 24 S.W.G. plate, was marked off and the holes trepanned for pressure gauges, regulators, switches and indicators, which would be mounted on it. Both panels, hinged to the cabinet frame, were covered with a black plastic sheet, cut out to suit the various units, engraved and held in position with a polished aluminium edging strip.

5.5. Assembly of the Control Cabinet

5.5.1. Assembly of Pneumatic-hydraulic Equipment. Figures 37 to 43

The three port micro-diaphragm valves were fitted to the cabinet frame angle brackets, as shown in Figure 37. Hydraulic fluid storage tanks for the cross-slide and turret slide power cylinders are fitted at one side as shown in Figure 39 with the five port diaphragm valve mounted underneath. Manifolds for the various pressure supplies were assembled in the frame, and after mounting the slave cylinders, as shown in Figures 38 and 40, were connected to the lower instrument panel. Copper tubing was used in all hydraulic circuits; some pneumatic circuits were also in copper to facilitate fitting and enable a compact layout to be achieved. In Figure 40, the slave

CONTROL CABINET FRAME AND TOP PANELS.

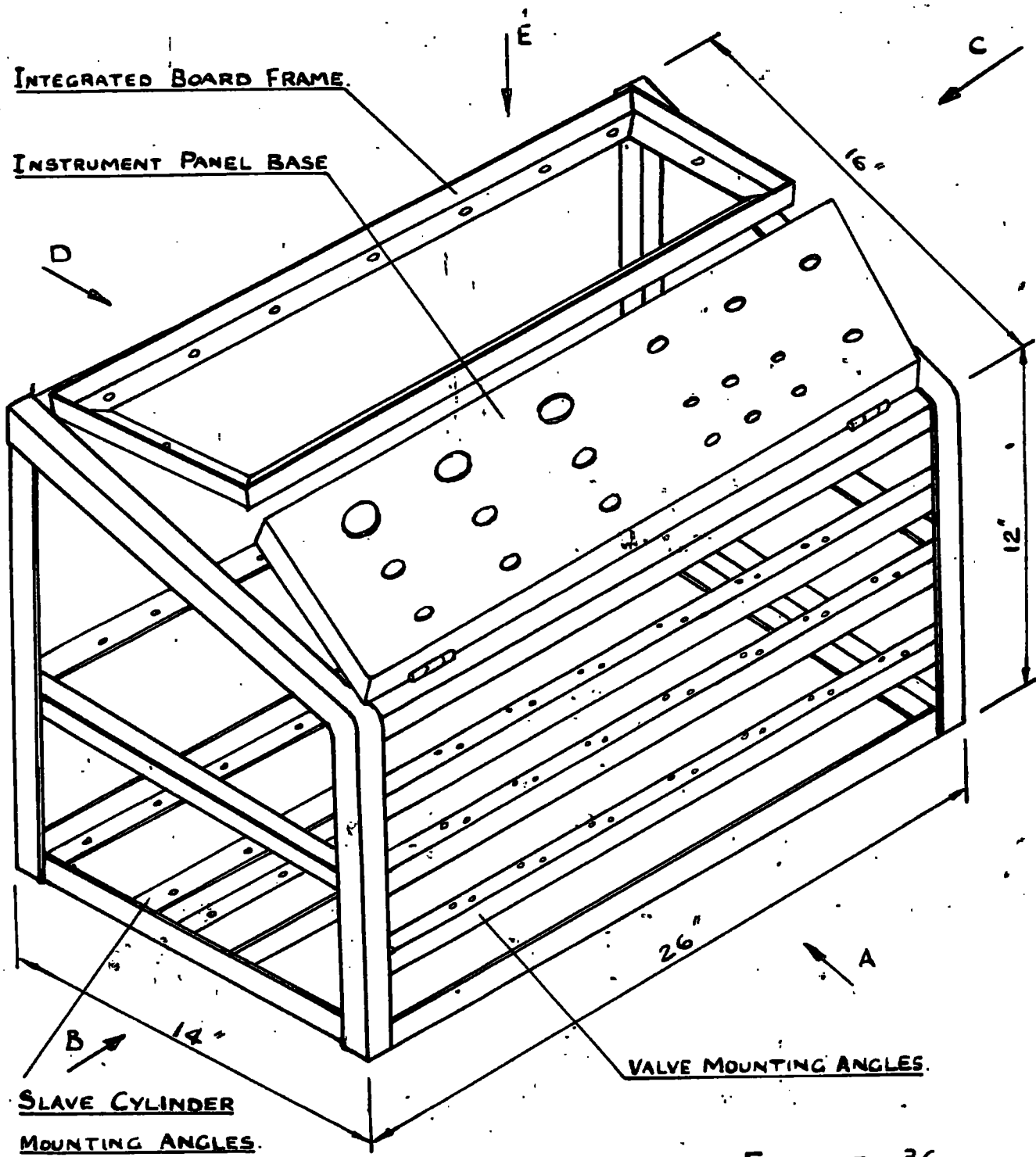

FIGURE 36.

CONTROL CABINET.

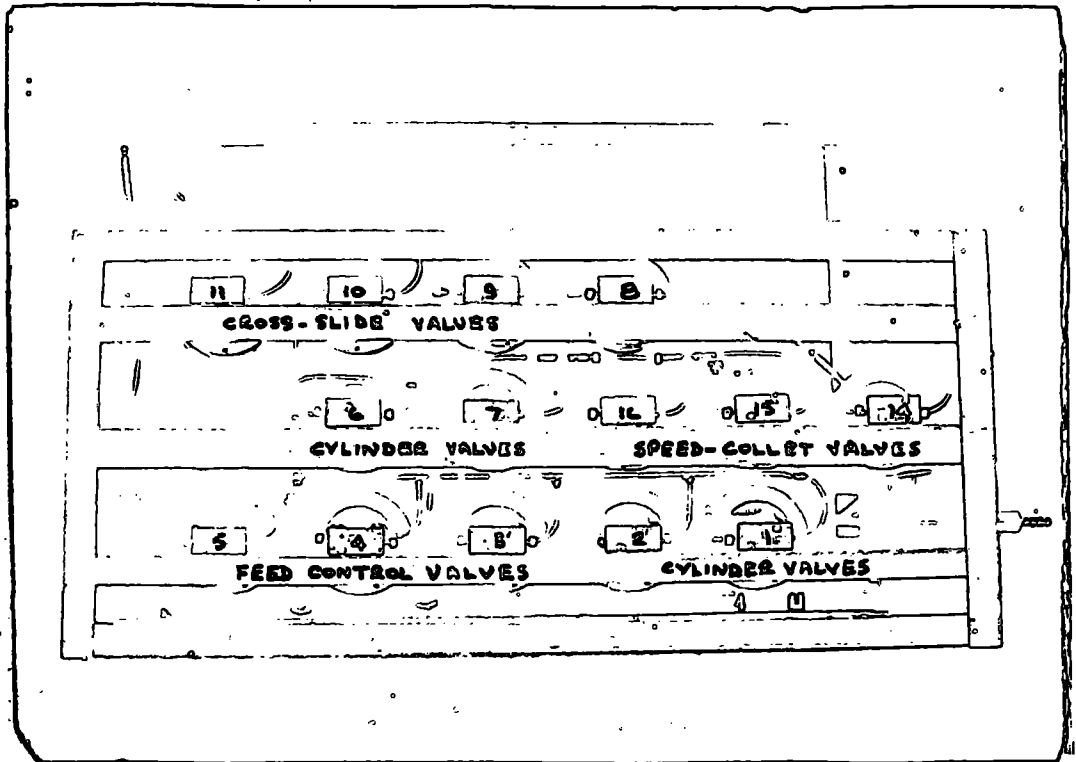

FIG. 37.

CONTROL CABINET.

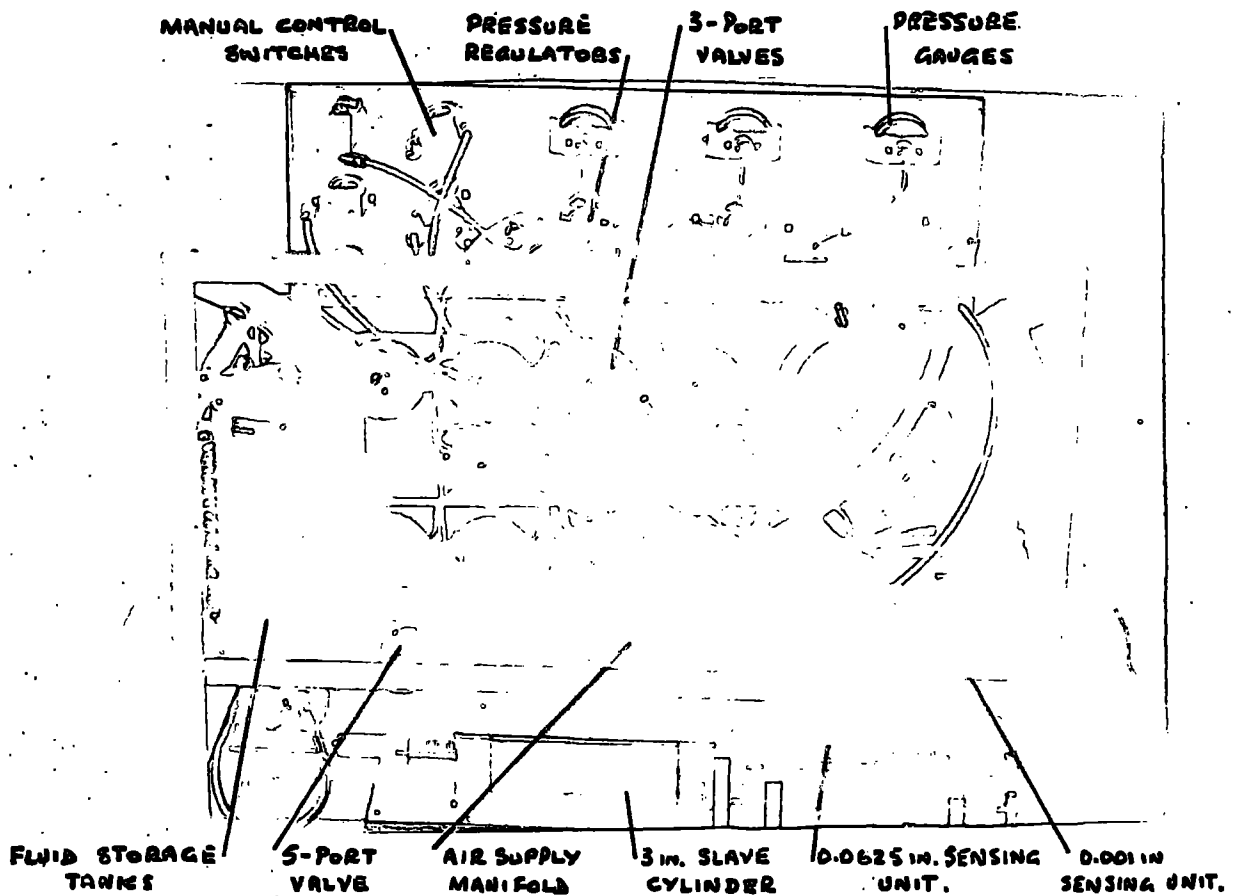

FIG. 38.

CONTROL CABINET.

LOWER INSTRUMENT
PANEL.

FLUID STORAGE
TANKS.

CROSS-SLIDE FLUID
STORAGE TANKS.

TURRET FLUID
STORAGE TANK.

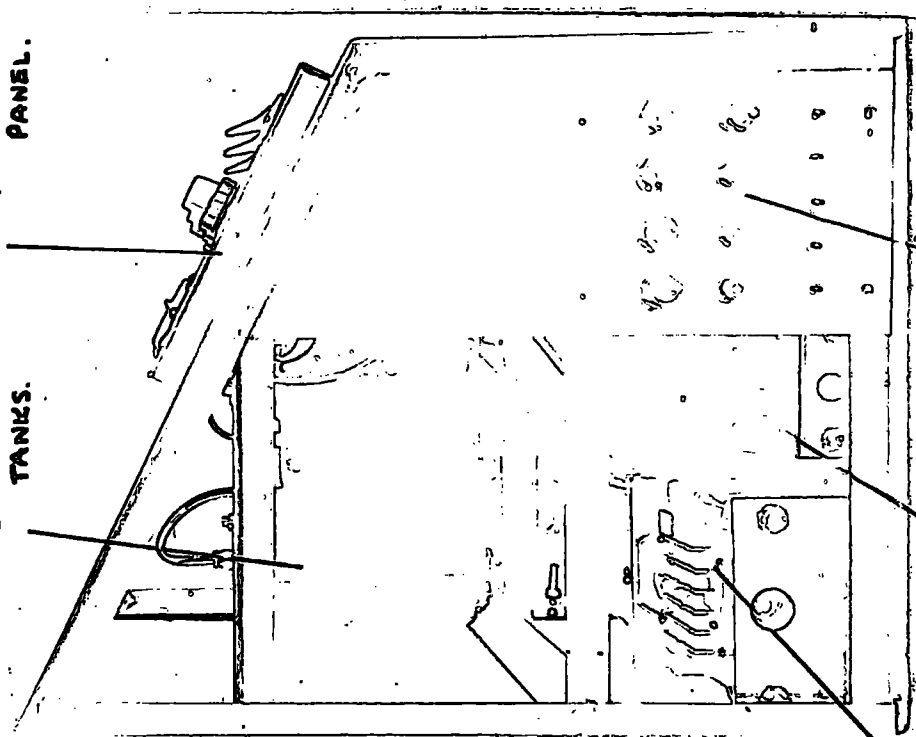

0-0625 SENSING UNIT.

0-001 IN. SENSING UNIT.

PNEUMATIC-HYDRAULIC-FLUIDIC CONNECTIONS.

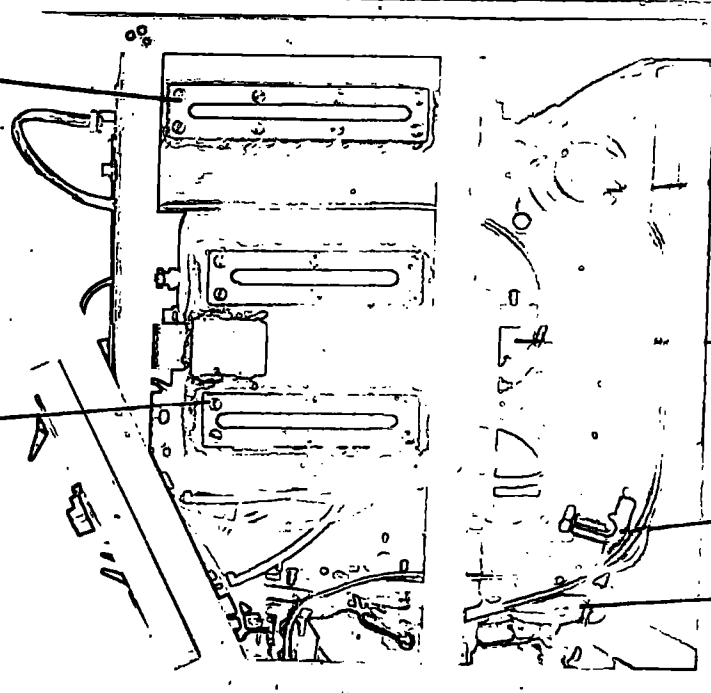

3-PORT VALVES.

FLOW REGULATOR

5-PORT VALVE

3 IN. SLAVE CYLINDER

FIG. 40.

FIG. 39.

CONTROL CABINET.

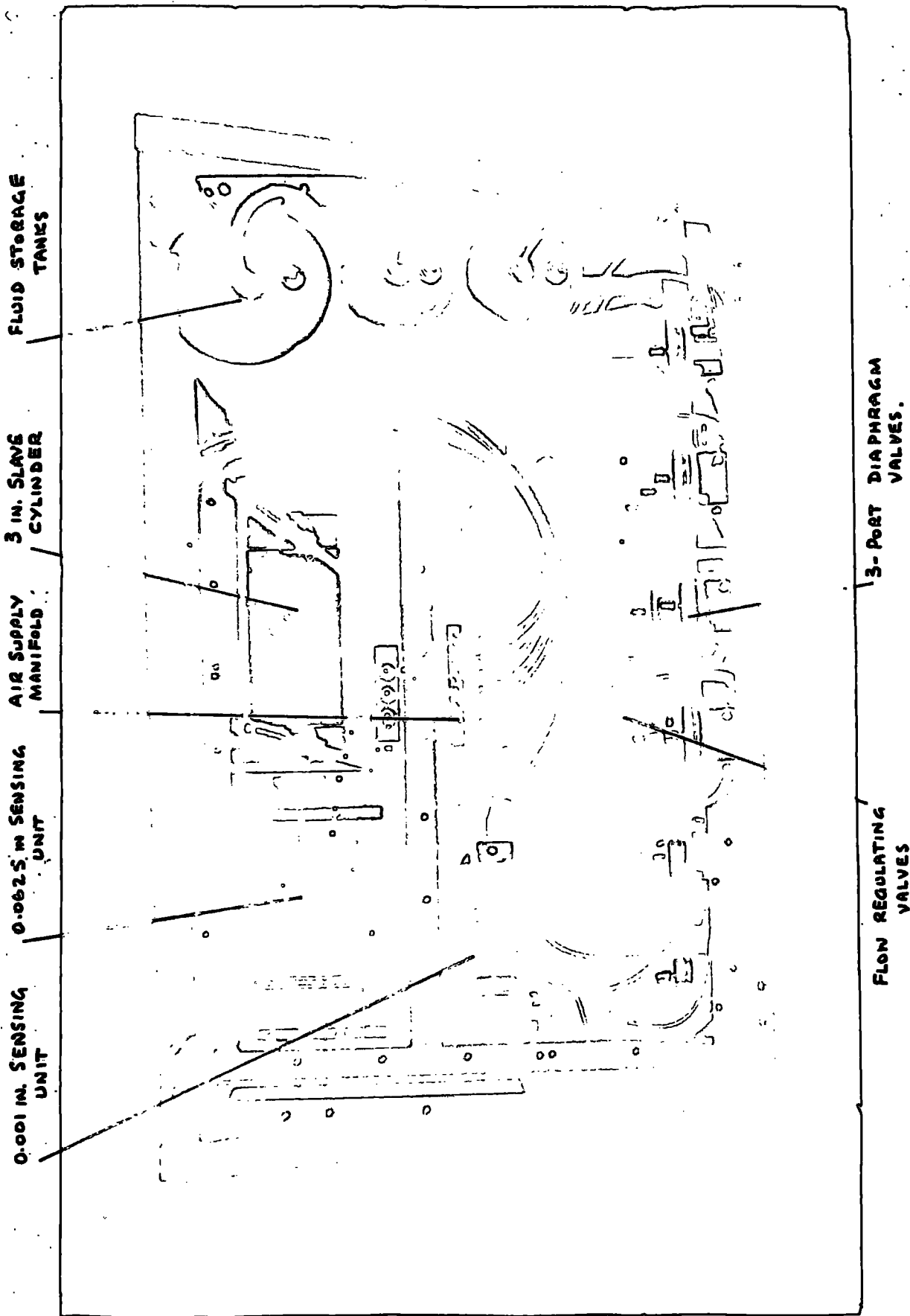

FIG. 41.

LOWER INSTRUMENT PANEL.

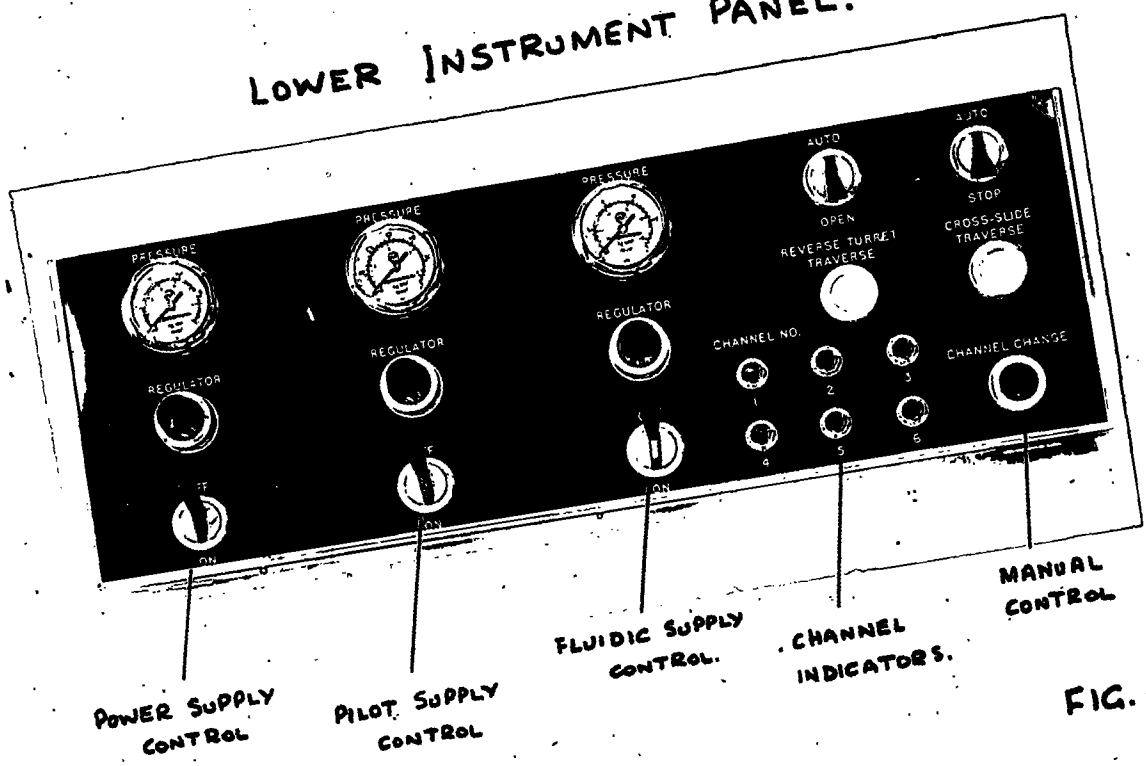

FIG. 42.

LOWER INSTRUMENT PANEL.

REAR VIEW - CONNECTIONS REMOVED.

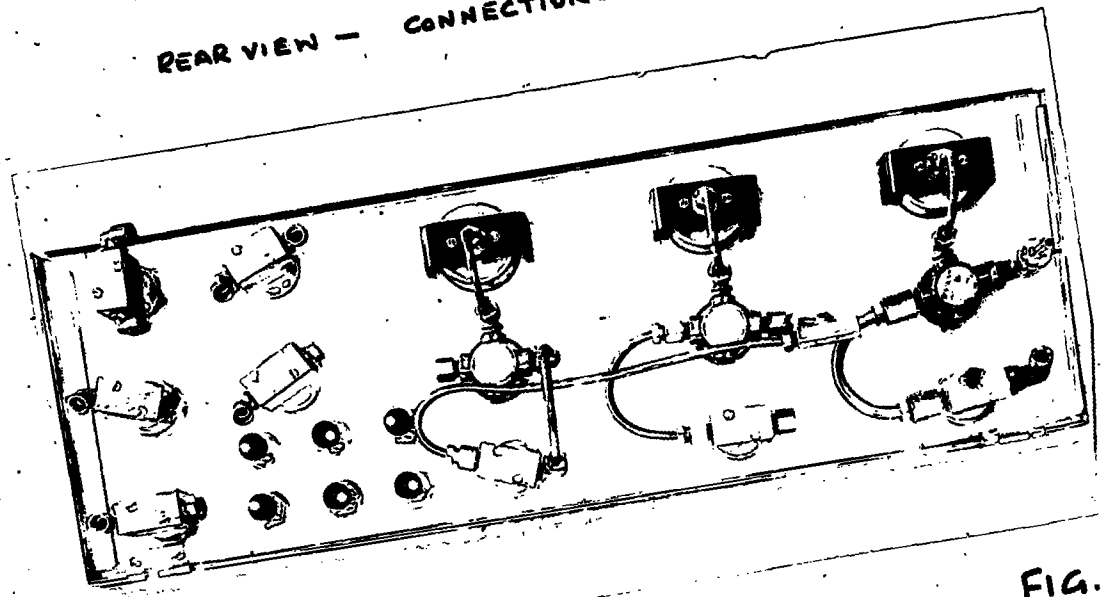

FIG. 43.

cylinders and sensing units can be clearly seen on the frame base. At the right hand side, are the cabinet external connections for the pneumatic, hydraulic, and fluidic pipes for the cross-slide, and the turret slide power cylinders. In Figure 41, a bird's eye view of the partly assembled cabinet, the general layout of tanks, cylinders, sensing units, valves and piping can be clearly seen. Figures 42 and 43 show the partly assembled lower instrument panel, with the pressure regulators, gauges, switches and indicators in position.

5.5.2. Assembly of Top Instrument Panel. Figures 44 to 46

Figure 44 shows the front face of the upper instrument panel fitted with the Rotary Programme Unit Figure 23, mounted on the relative circuit boards, with the black facia panel and trim in position. When fitting the Programme Units, particular care was taken to ensure that the signal grooves were free from foreign matter, and that the units were an air tight fit on the circuit boards. On the back of the Integrated Circuit Boards, the junction, cross-slide, back pressure signal and channel supply manifolds were fitted as shown in Figure 45. Using 1/16 inch diameter flexible polythene tube in a variety of colours, connections between the back pressure signal manifold and Circuit Boards were made, followed by the channel supply pipes from the channel supply manifold to the various programme units. Pipes from odd numbers of the cross-slide programme unit were fitted into one side of the manifold, and even numbers to the other side. From the underside of this manifold, connections were made to one branch of the Junction manifold; another branch being connected to the 0.0625 inch distance Programme unit; the third branch to the Programme Unit starting the feed. Figure 46 shows the general arrangement of the signal pipes, those on the left hand side going to the Slave cylinder sensing units, the right hand side for speed, feed etc., and to fluidic devices.

5.5.3. Fluidic Unit Boards. Figures 47 to 50

The fluidic circuit diagrams shown in Figures 10 to 15 were compiled into two Fluidic Unit Boards, each comprising of several manifolds and mounting boards on which the fluidic devices were fitted. The unit shown in Figure 47 contains logic circuits controlling the channel selection, Cross-slide control, Selector switchboard and Valve Control. The rear of this board, Figure 48, shows the supply manifolds, interconnections, input signal pipes from the Integrated Circuit Board, turret, and cross-slide sensing

UPPER INSTRUMENT PANEL.

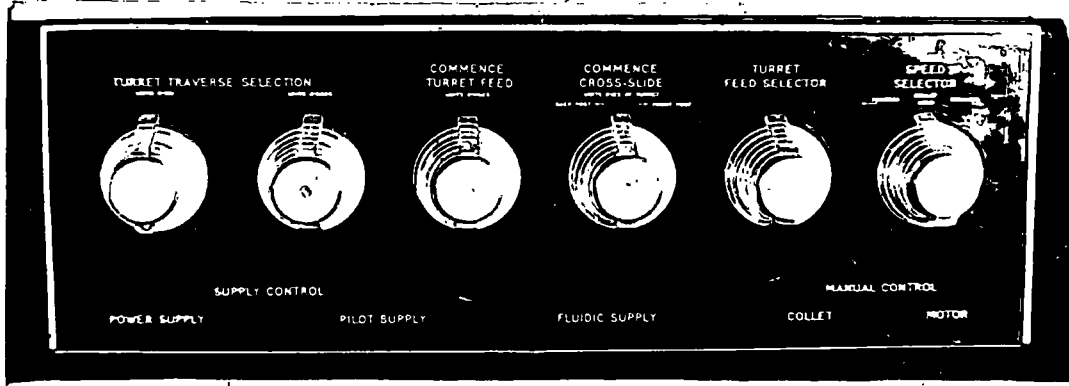
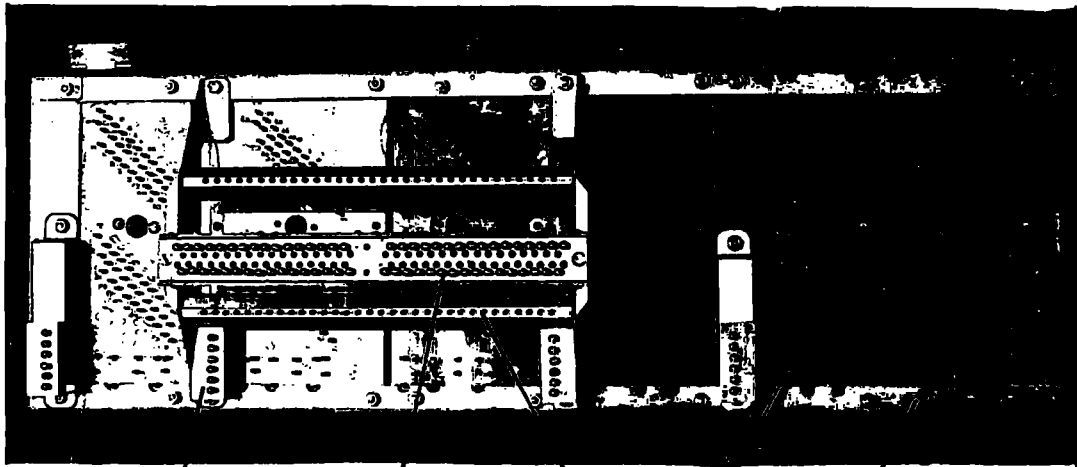

FIG. 44.

UPPER INSTRUMENT PANEL

WITHOUT PIPING.



BACK PRESSURE SIGNAL MANIFOLD CROSS-SLIDE MANIFOLD JUNCTION MANIFOLD CIRCUIT BOARD ANGLE FRAME.

FIG. 45.

UPPER INSTRUMENT PANEL

WITH PIPING.

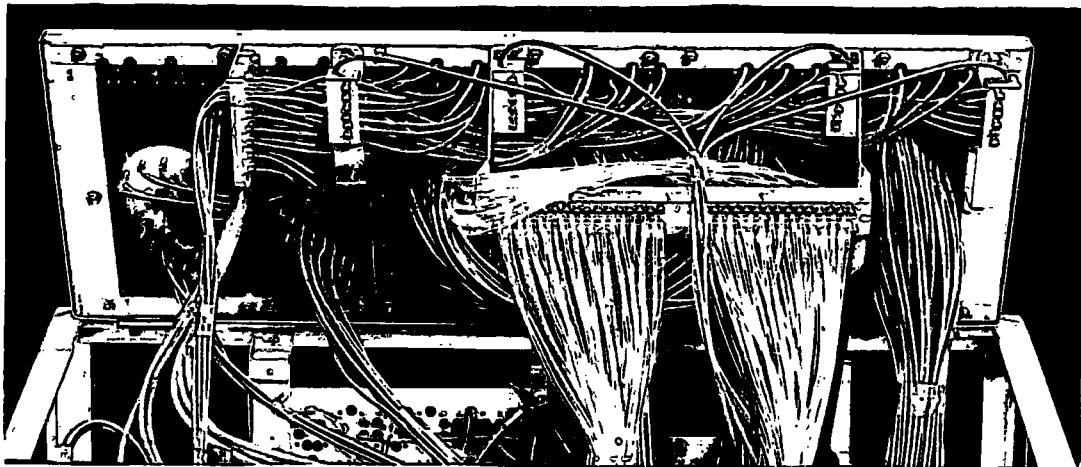
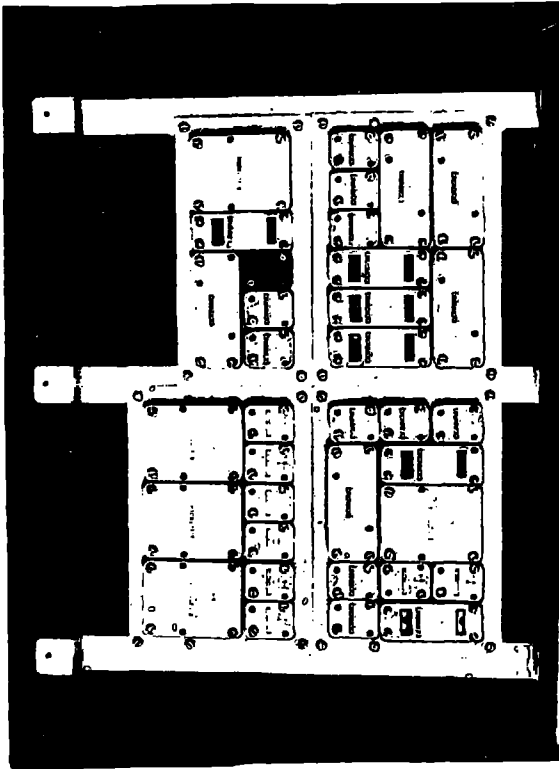

FIG. 46.

FLUIDIC UNIT BOARDS.



FRONT.

FIG. 47.

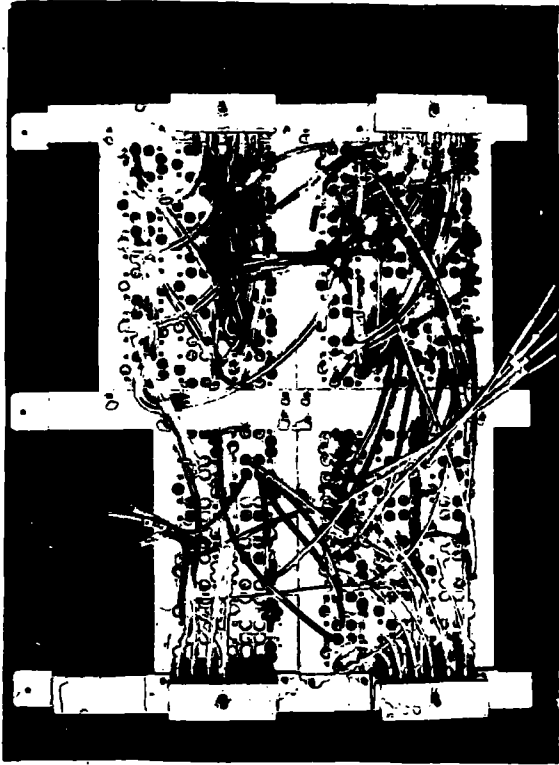

REAR

FIG. 48

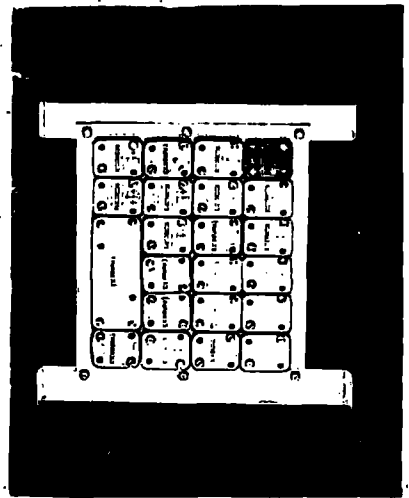

FRONT.

FIG. 49.

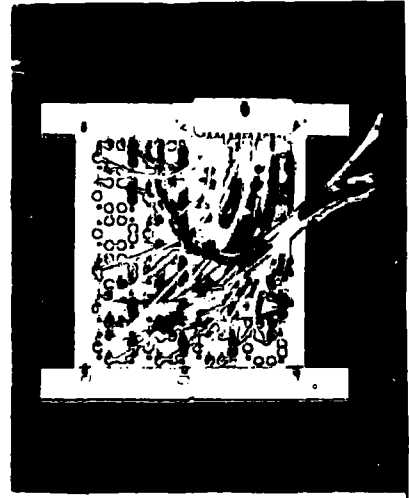

REAR

FIG. 50

units; signal pipes from the fluidic devices to the diaphragm valves are not fitted. The board shown in Figure 49 contains the logic circuits controlling the feed selection and the speed-collet operation. Figure 50, a rear view of this board shows the supply manifold, and the interconnections between devices made with flexible polythene tube.

5.5.4. Assembly of Instrument Panels and Fluidic Boards in the Control Cabinet. Figures 51 - 55

The lower instrument panel had been fitted to the cabinet when the pneumatic and hydraulic pipes were installed. This enabled interconnections to be made between inlet connections and manifolds, as shown in Figures 40 and 41. The panel was then removed to facilitate the fitting of other sub-assemblies. The Upper Instrument Panel, Figure 45 was fitted to the cabinet, connections were made between the Integrated Circuit Boards, Manifolds, and the sensing units of the 0.5 and 3 inch Slave Cylinders with 1/16 inch diameter bore polythene tube. The Lower Instrument panel was then replaced and re-connected; Figures 51 and 52 show the arrangement of the pipe connections with the panels open. Connections between the Fluidic Boards and other Units, can also be seen in Figures 51, 52 and 53, as they would be viewed by maintenance staff. Figures 54 and 55 are views with the panels closed, as seen by an operator. The control panel has yet to be connected to the machine tool power cylinders and sensing units.

CONTROL CABINET.
FLUIDIC BOARD OPEN.

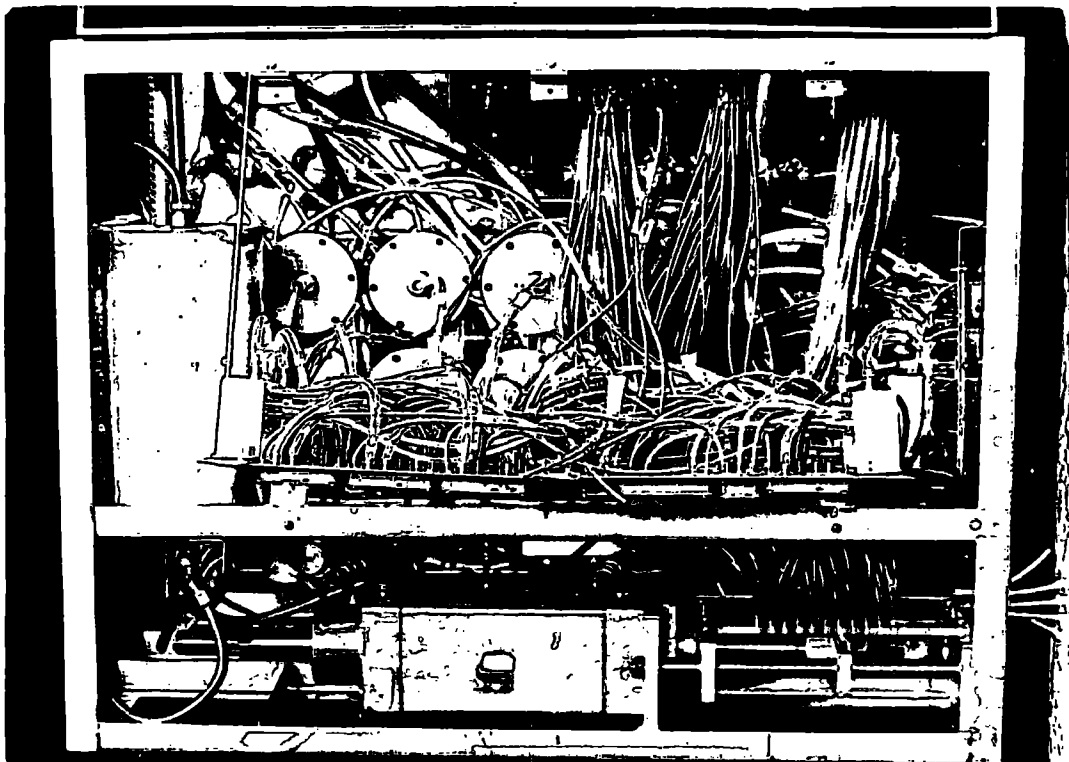

FIG. 51.

CONTROL CABINET.
INSTRUMENT PANELS OPEN.

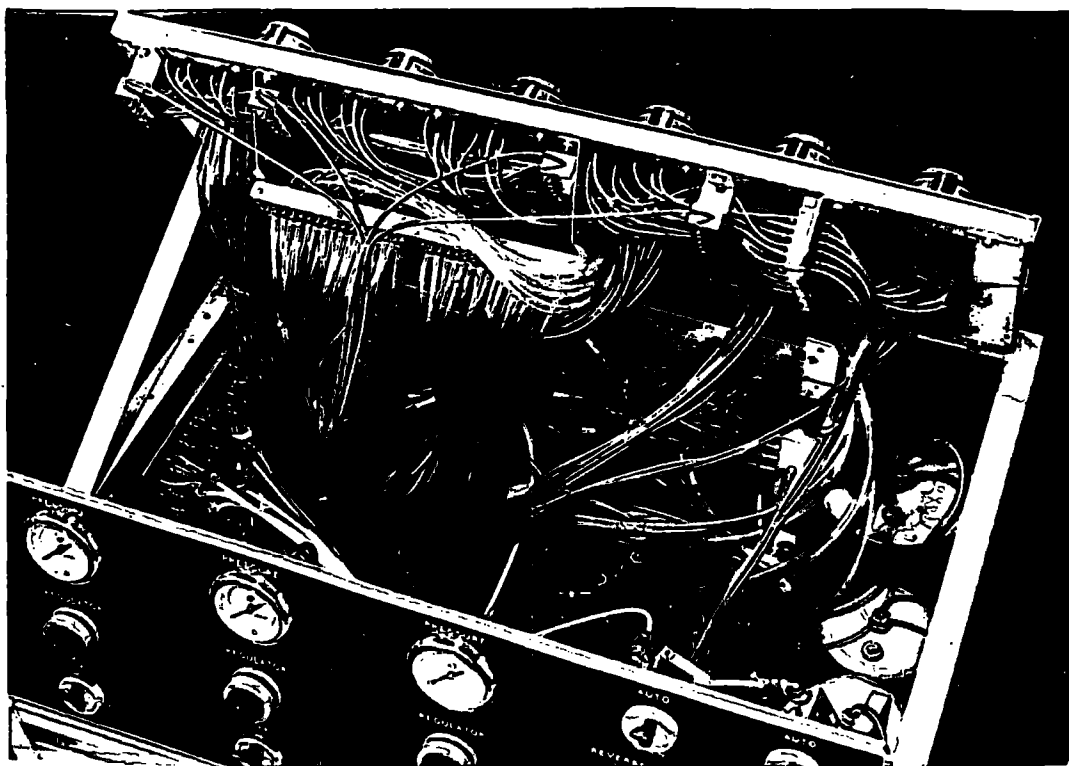

FIG. 52.

CONTROL CABINET.
INSTRUMENT PANELS OPEN.

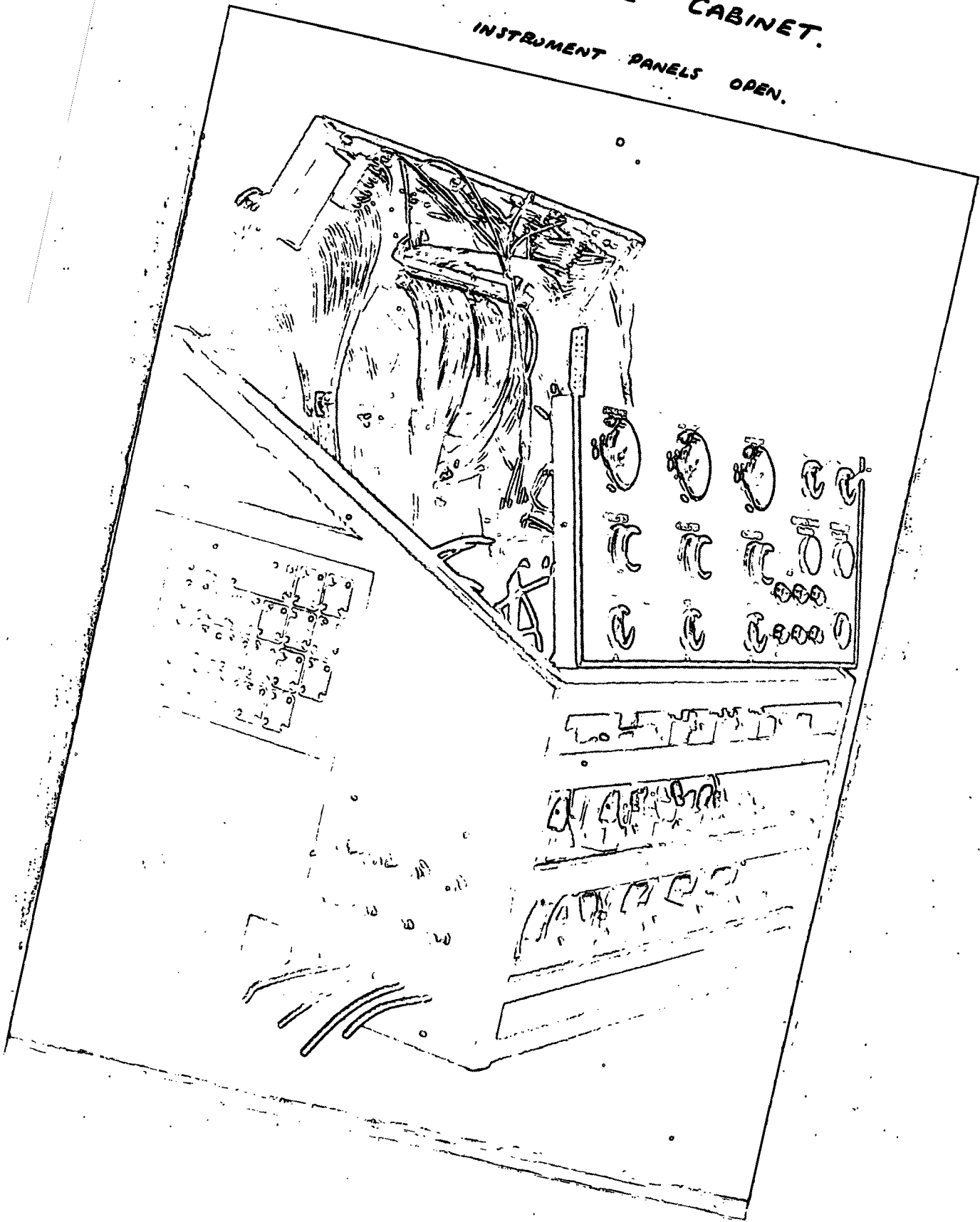

FIG. 53.

CONTROL CABINET.

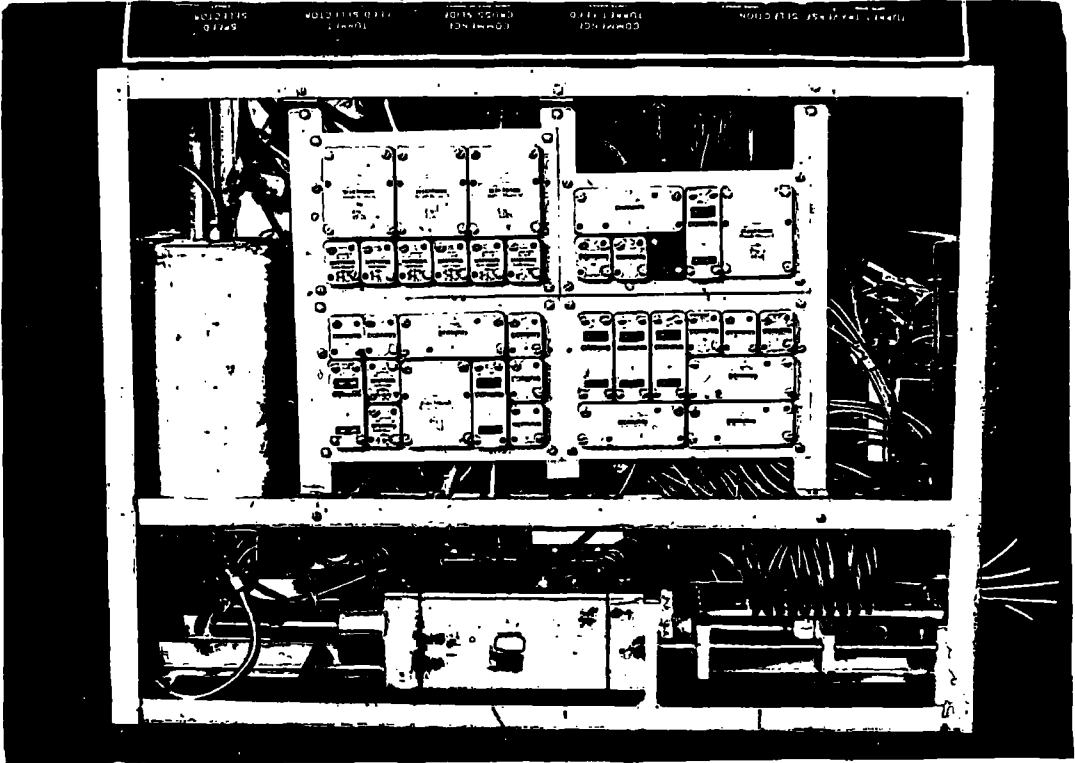

FIG. 54.

CONTROL CABINET.

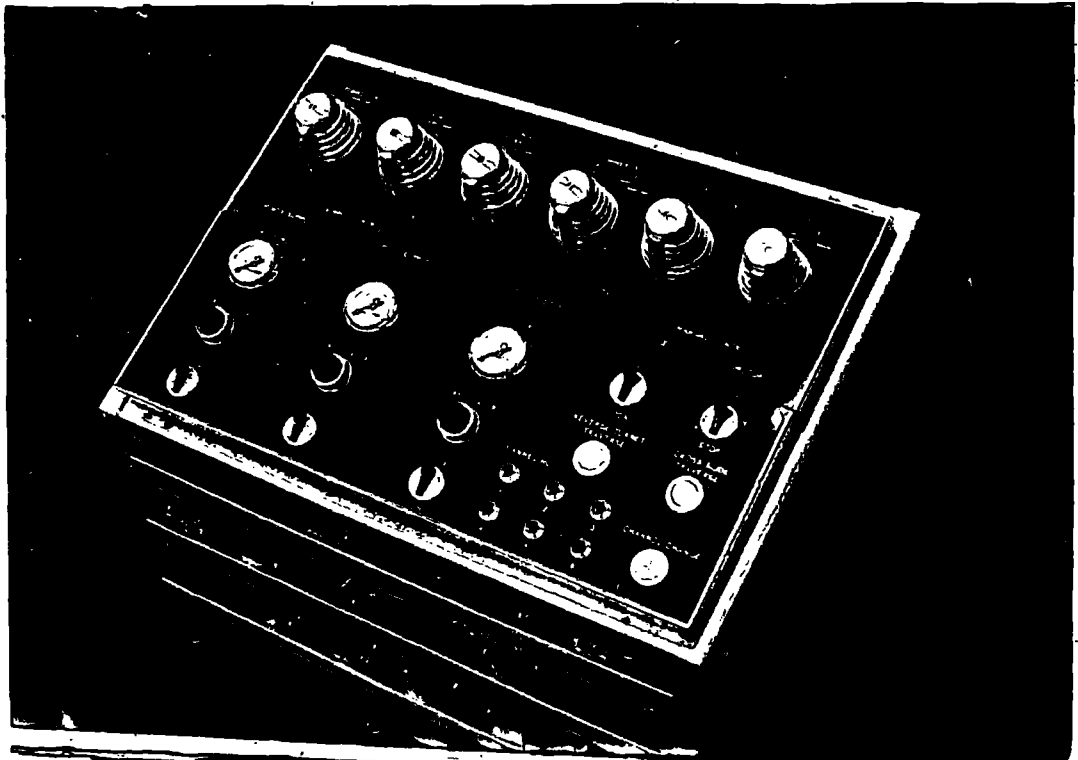

FIG. 55.

CHAPTER VI

Commissioning

After each unit or sub-assembly of the control system had been manufactured, preliminary tests were performed, whenever possible, prior to final assembly. For convenience the system was divided into the following sections, and tests for pressure drop, response, leakage and performance were carried out.

1. Cylinders and sensing units
2. Programme system
3. Address system
4. Logic system

When the test results indicated a fault, an alternative or improvement was suggested in design; they were investigated, the unit under test was modified or re-designed and manufactured.

6.1. Performance of Cylinders and Sensing Units

The tests performed on the units, were arranged to check the repeatability of the cylinder positioning, the response of valves and fluidic devices to reverse cylinder motion, the effect of air pockets in the cylinder, and the traverse speed on the over run.

6.1.1. Preliminary Cylinder Tests

The following equipment was used to test the cylinder units before fitting into the control cabinet and onto the machine simulator.

- 2 - Fluid storage tanks
- 4 - Three port diaphragm operated valves
- 1 - Bistable fluidic device
- 2 - Back pressure sensing fluidic devices
- 1 - 0.0001 inch Dial test indicator and stand
- 1 - Multi-column monometer
- 1 - Mounting board
- 2 - Flow control valves
- 1 - Three port lever operated valve

Each cylinder piston was positioned mid-way in the cylinder and each side was filled with fluid, One cylinder inlet port was connected to Fluid storage tank with a flow control and three part diaphragm valve in the circuit. The piston was moved, forcing the cylinder fluid through the pipe, flow control, and the three port valves into the storage tank to remove the air from the circuit. This tank was then filled up with fluid to within an inch of the top and then connected to the outlet port of a pneumatic supply valve. The cylinder outlet port was connected to the second storage tank in a similar manner. The pneumatic supply three port valve in the first circuit was activated, and fluid from the storage tank returned the piston to exclude air from the second circuit. The second fluid storage tank was then filled, and connected to the outlet port of a second pneumatic supply three port valve. Two sensing devices on the unit were selected, and connected to the back pressure fluidic devices, their output O2 connected to the C1 and C3 controls of the bistable device; output O1 and O2 of the bistable, activating the three port diaphragm valves. Mains air pressure at 60 pounds per square inch, and an auxiliary supply at 10 pounds per square inch, was connected to the valves and fluidic devices; the dial indicator was positioned to contact the piston rod at the end of its length of stroke.

6.1.2. Preliminary Test Performance

When the air supply was switched on, the bistable output operated the diaphragm valves to pressurise one storage tank and vent the other to atmosphere. Fluid, forced from the pressurised tank, passed through flow control and "hydraulic lock" three part valves into the cylinder. Fluid from the opposite side of the cylinder piston, flowed through the pre-set flow control and three port valve, into the second tank.

When the travelling probe of the sensing unit, fitted to the cylinder, covered the selected sensing device orifice, a signal from the back pressure fluidic device connected to the orifice, switched the bistable output to change the valves over. The valves in the hydraulic circuit provide the "hydraulic lock" to reduce over run of the sensors by the probe. The pressurised tank is vented to the atmosphere: simultaneously the other tank is pressurised and the "hydraulic lock" is removed to reverse the direction of the piston movement. The dial test indicator reading was noted during the change-over in piston movement. As the piston

returned, the second sensing device was activated and the motion was reversed. To check the repeatability of change-over position, a range of piston speeds was selected by regulating the flow control valves, and the dial test indicator readings noted.

6.1.3. Preliminary Cylinder Test Conclusions

The length of the 1/16 inch diameter signal pipe between orifice and back pressure switch affected the response owing to a combination of pipe resistance, capacitance and orifice size. Increasing the orifice diameter from 0.03 to 0.05 inches and the width of the travelling probe enabled a higher pressure to be used, which gave a marked improvement in sensitivity and response. Valve response time proved to be irregular when operating the diaphragms at the minimum pressure of two pounds per square inch, which is the output pressure of a bistable device with a supply pressure of ten pounds per square inch. Increasing the bistable supply to fifteen pounds per square inch provided an output of three pounds for valve operation, which removed the problem. The supply to the back pressure switch was reduced to eight pounds per square inch, as the output at this pressure, 20% of the supply, gave positive switching of the bistable device and some reduction in the air consumption. The results obtained for the repeatability of piston positioning are acceptable at this stage, but a test for reliability based on valve life is necessary. Care must also be taken to remove air from the cylinders and circuit or an uncontrollable variation in the piston position occurs.

6.1.4. Installed Cylinder Tests

On completion of the preliminary tests and minor modifications, each cylinder was installed into the system and connected to the Programme, Address and Logic circuits. A programme was selected and the system was allowed to perform a series of cycles until the pressure, flow and control valves were set and other minor adjustments completed. The count circuit was then isolated and set to provide a continuous supply to programme channel number two. Positional repeatability tests were then commenced on the cross-slide and turret slide motions, various rates of piston speed were used for each sample of fifty cycles of operation; the dial test indicator readings were noted and plotted.

6.1.5. Installed Cylinder Test Results

Three piston speeds, one inch, three inches and six inches

per minute were selected; results of the repeatability tests are as follows:-

Piston speed, one inch per minute

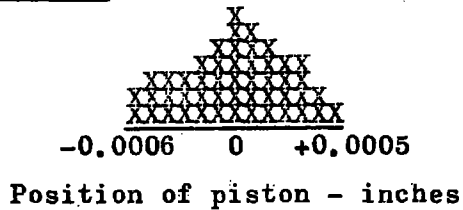

Piston speed, three inches per minute

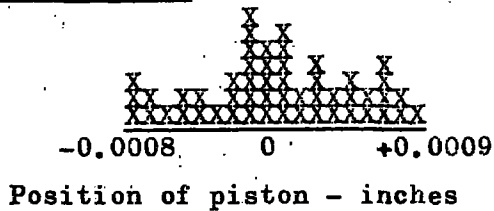

Piston speed, six inches per minute

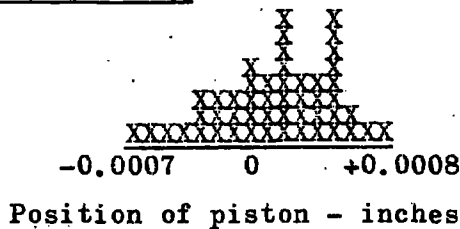

6.1.6. Installed Cylinder Test Conclusion

The dial test indicator readings did not give the anticipated distribution curve at the higher piston speeds. Also it had been noticed that after several consecutive readings within plus or minus 0.0002 inches of a mean valve, the following five to six readings were distributed about a slightly higher or lower valve. A further test of one hundred cycles was instigated, the piston speed was increased to twelve inches per minute and supply air pressures were noted. As the test progressed, the variation in the mean value for each five to six cycles of operation, produced a curve, which was relative to supply pressure variation caused by the regulating valve differential pressure. It can be seen from the results of this test, that a pressure variation of 10% has a detrimental effect on repeatability when high piston speeds are used.

Piston speed, twelve inches per minute

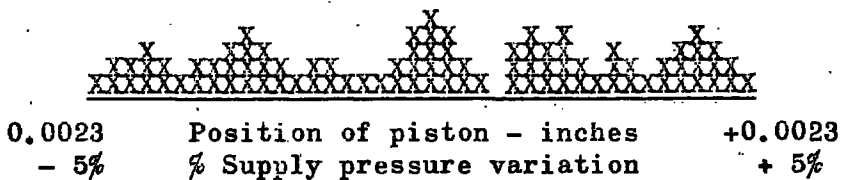

In a series of random tests which followed the one shown above, it was possible to predict the piston position within plus or minus 0.0002 inches, by noting the supply pressure. It was concluded that supply pressure variation, which could be greatly reduced with a precision pressure regulating valve, was the major factor in repeatability, because of its effect on the rate of fluid flow through the flow control valves.

6.2. Performance of the Programme System

This system consists of the Rotary Programme Units, and the integrated circuit board, which had been tested during manufacturing, and is described in Chapter 5.4.4. As a result of the tests, several modifications were made, and the circuit board airways became 90% to 95% efficient when tested with a pressure of 60 inches water gauge.

6.2.1. Rotary Programme Unit Test

The Rotary Programme Unit could not be tested as an individual unit owing to signal hole size and arrangement; it was therefore necessary to mount each unit on one of the circuit Boards fitted with connecting pipes. The equipment utilised in the test was:-

- 1 - Circuit Board
- 2 - Multi-column monometers
- 1 - Fluidic supply manifold
- 1 - Multi-connection junction block
- 2 - Variable restrictors
- 1 - Schmitt Trigger fluidic device
- 1 - Water tank

The Rotary Programme Unit baseplate and core, items "A" and "B" Figure 24, were fitted to the circuit board. Channel dial item "C" fitted on the core, and the vertical output signal grooves in the core, stopped off with modelling clay to prevent signal loss. Air pressure in the fluidic supply manifold was adjusted to 60 inches water gauge, and a connection made to Channel 1 input pipe on the circuit board; the monometers being connected to the output signal pipes. By rotating channel dial "C" to aline the radial connecting hole with the vertical

output signal grooves in Core "B", the pressure drop, and signal transfer could be noted on the monometers.

Air loss between the horizontal joint faces was detected by submerging the unit into the water tank. The remaining dials were fitted and tested in a similar manner until the Programme Unit was assembled; leakage between the various channels could now be checked with the monometers. The air supply from the manifold to the unit was disconnected, and a tee-junction with a variable restrictor was inserted to provide a back pressure signal tapping point for the Schmitt Trigger fluidic device.

6.2.2. Rotary Programme Unit Performance

The tee-piece and Programme Unit output pipes were connected to monometers; the air supply was re-connected, pressures were noted and the variable restrictors were adjusted. With a supply pressure of 60 inches water gauge, the pressure at the sensing unit was 15 inches and the back pressure was 20 inches water gauge. When the sensing device was operated, the back pressure increased to 24 inches, a 4 inch differential pressure to the switch output of the Schmitt Trigger. Connecting the back pressure signal pipe to control C1 of the Schmitt Trigger gave output O1. A bias signal adjusted to 21 inches water gauge, connected to control C2 switched the output to O2 as it was greater than the initial back pressure signal. When the sensing device was operated, the back pressure signal increased to 24 inches; the bias signal was inhibited; and the output was changed to O1 to control other logic devices, where as output O2 vents to atmosphere.

6.2.3. Signal Pressure Drop

Similar tests were performed on each Channel Dial, but a variation in the output pressure, owing to the cumulative effect of the joint face leakage, resistance to air flow within the unit and signal transfer, shown in Figure 56, reduced the sensing device and differential pressures in some instances to 5 and 1 inch water gauge respectively. The introduction of restrictors in each Channel Circuit adjusted outputs to a common value; the bias signal was adjusted to suit the smallest differential pressure. The limits between function and non-function were now reduced to

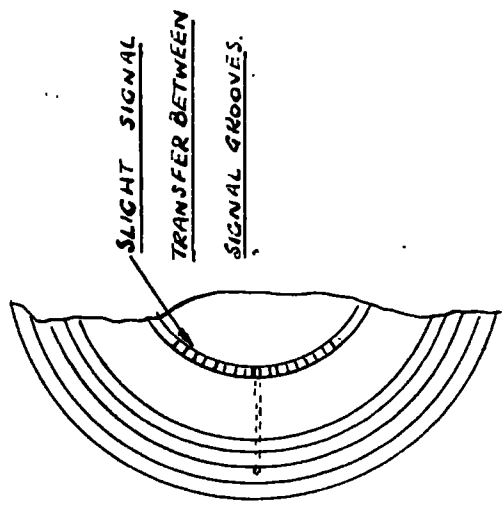
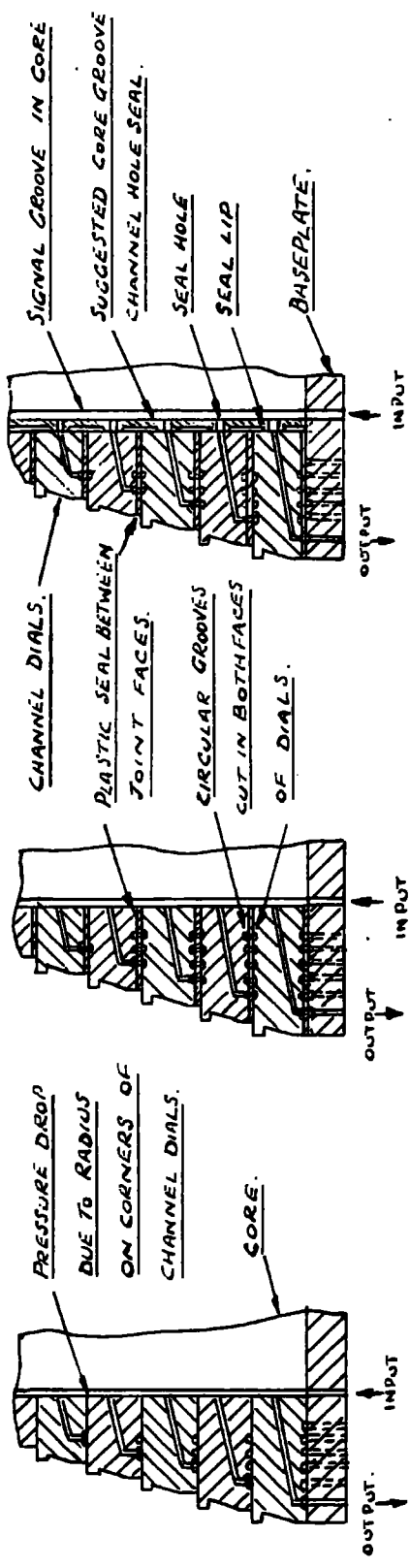

FIG. 56.

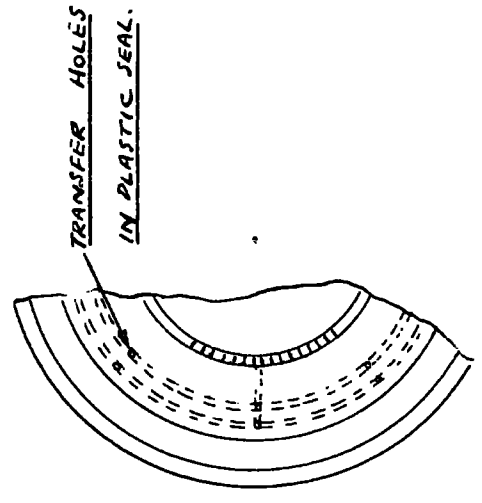

FIG. 57.

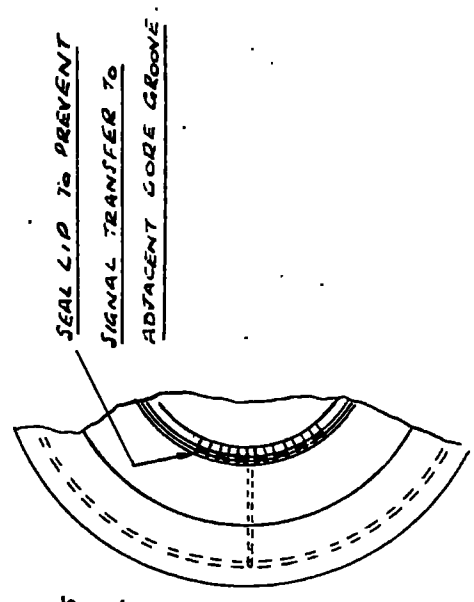

FIG. 58.

an unsatisfactory level where a slight variation in circuit resistance between sensing devices, or fluctuation in supply would cause malfunction. The reduction in unit performance between these and the preliminary tests, described in Chapter 6.2.1. was due to leakage between the dial face circular grooves and the core vertical grooves. The resistance due to any variation in the circuit length of the various channels, was secondary.

6.2.4. Modifications to the Rotary Programme Unit

Figure 57 shows the modifications made to the unit; additional circular grooves were cut in the opposite face of each Channel Dial and a polythene washer was inserted between the dial faces. The transfer holes connecting the grooves in each face were also enlarged to reduce resistance. The improved output pressures were noted on testing but their effectiveness was offset by an increase in signal transfer between the vertical core grooves. The increased volume of airways, due to the additional grooves, had a noticeable effect on the back pressure signal response, especially where leakage between the dial and core would occur. A thin grease was smeared on the core and in the dial bore, to act as a seal, confirmed, that the bore and core fit was responsible for the poor performance. Prior to the use of grease as a seal, leakage pressures in adjacent vertical core grooves to the one programmed, averaged 1 inch water gauge, with a maximum of 3 inches water gauge. The solution to these losses would appear to be a synthetic rubber seal as illustrated in Figure 58; the Channel Dial joint face seal could also be moulded in a similar material and would incorporate the circular grooves instead of having to be machined in the dials. The use of these seals would, in addition to the improved performance, reduce manufacturing time and permit wider tolerances to be used on the components. It is unfortunate that facilities to produce such seals were not available, and it was necessary to examine in greater detail the Endless Tape Programme Unit considered in Chapter 3.4.

6.2.5. Tape Programme Unit

The design, illustrated in Figure 59, had been discarded earlier in this project due to its relatively large physical dimensions, about 6.5 x 4 x 1.5 inches, and that it did not lend itself to mounting on a circuit board. The unit consists of a perspex block with sixty four transverse grooves staggered on a horizontal plane to facilitate signal pipe connections. In the

TAPE PROGRAMME SELECTOR UNIT.

FIG. 59.

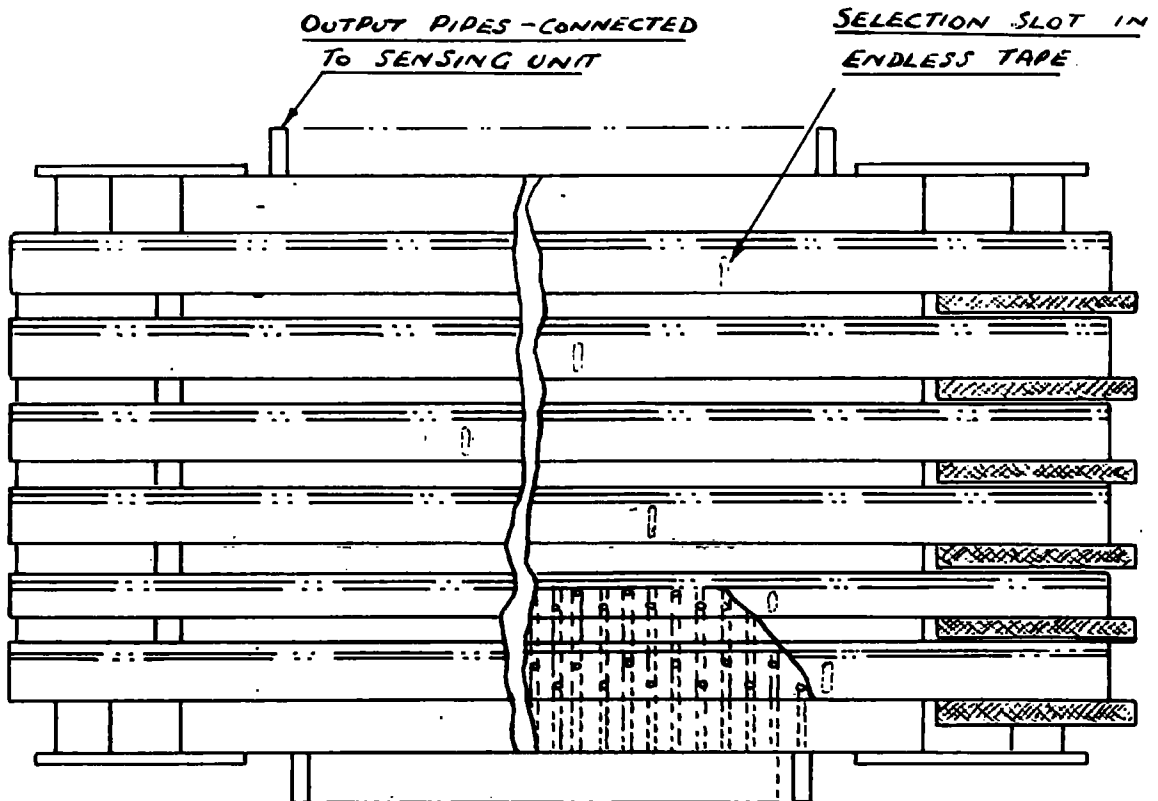
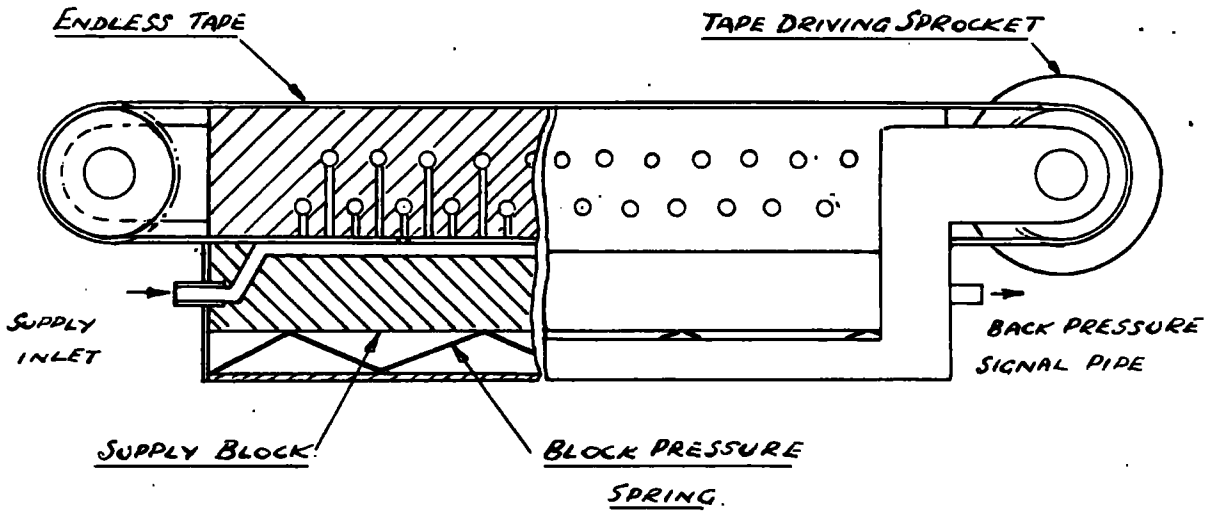

top face are six grooves, one for each programme channel, in which an eight millimetre wide endless tape slides, revolving round an idler pulley at one end, and traversed by a driving sprocket at the other. Each tape, sealed sixty four vertical holes drilled into the transverse grooves, except for one hole, in line with a 0.04 x 0.1 inch slot cut in the tape. Air was supplied to a groove in a spring loaded polythene supply block, which holds the tape in position, passing through the tape slot, down the vertical hole, and out of the transverse groove to the sensing unit. When the sensing device was activated, air pressure increased in the polythene supply block and the increase in back pressure signal strength, triggered the appropriate fluidic device, usually a Schmitt Trigger. To programme a particular sensing device of a sensing unit, the tape is moved by rotating the sprocket until the tape slot coincides with the appropriate hole connected to the device. Accurate positioning of the tape is necessary to prevent partial blockage of the vertical hole. This is facilitated by a mark on the tape and an engraved scale fitted to the control panel as shown in Figure 63.

The components for the unit can be seen in Figures 60 and 61, they are:-

1. Item A. Perspex laminated block
2. Item B. Tape driving sprocket
3. Item C. Sprocket disc
4. Item D. Idler roller
5. Item E. Spindle bracket
6. Item F. Spindle
7. Item G. Mounting feet
8. Item H. Tape
9. Item I. Polythene supply block
10. Item J. Pressure pads
11. Item K. Pressure plate
12. Item L. Fluidic device mounting plate

The perspex block, item A, is laminated from three pieces of quarter inch thick perspex; the bottom and middle plates each have thirty two transverse grooves 0.030 inches wide by 0.040 inches deep at one eighth of an inch centres, cut in one face. The top plate has six longitudinal grooves, 0.0625 inches deep by 0.325 inches wide, to suit the tape. In each of the six grooves are sixty four 0.03 inch diameter holes; thirty two line up with the transverse grooves in the middle plate, the remainder, with thirty two holes in the

TAPE PROGRAMME UNIT.

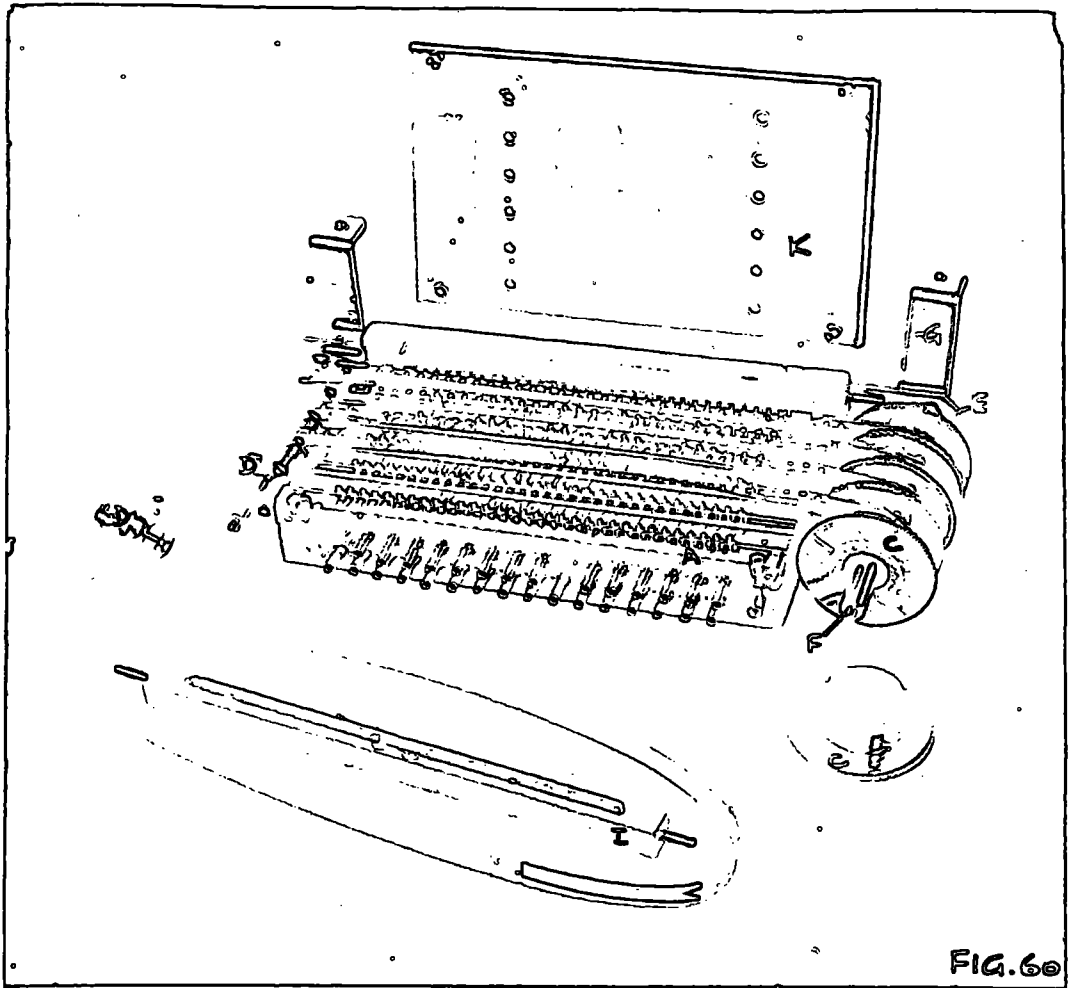

FIG. 60

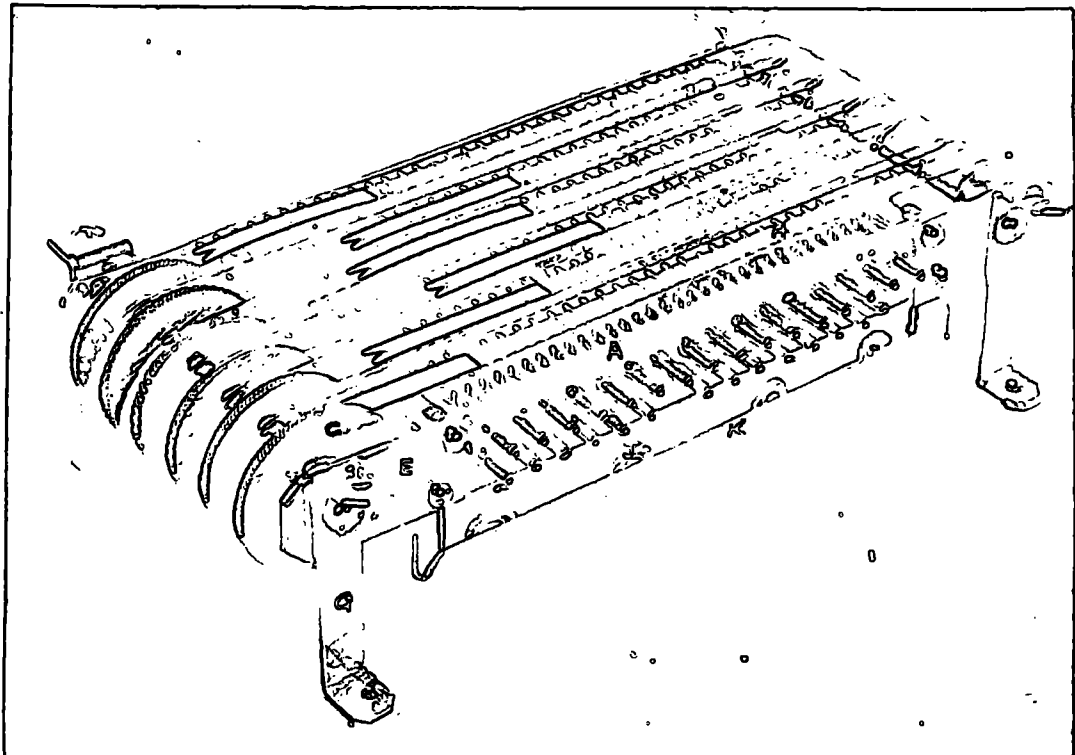

FIG. 61

middle plate which line up with the transverse grooves in the lower plate. The accurate positioning of these holes was achieved with the aid of a plate drill jig. After cleaning the holes, grooves and joint faces, the plates were bonded together in a similar manner to that used for the Circuit Board, described in Chapter 5.4.4. Holes were drilled and tapped in the block side for brackets, item E. The Tape Driving Sprocket, item B, was produced by conventional plastic moulding techniques, a die having been manufactured for the purpose. On the spigot of the sprocket, item C, the aluminium Sprocket Disc was bonded. When the aluminium Idler Roller, item D, the aluminium Spindle Bracket, item E, and the mild steel spindle, item F, were completed, they were fitted to the block, item A. The tape, item H, manufactured from eight millimetre film, was measured for length and the ends were spliced to make an endless tape. After cutting the 0.04 x 0.1 inch slot in the tape, it was fitted round the Idler Roller, Driving Sprocket and into the 0.325 inch wide groove. When correctly tensioned, the spindle and bracket screws were tightened. The Polythene Supply Blocks, item I, produced with a simple moulding tool, were fitted with supply and back pressure signal pipe connections. After the joint face had been lapped flat, they were fitted into the tape slot and the air seal between this block, the tape and the perspex block was tested. When the seal on each of the six channels was satisfactory, the Pressure Pads, item J, and Pressure Plate, item K, were positioned on top of the Polythene Supply Blocks, the screws were inserted and tightened.

At this stage, the unit was again tested; if the performance was below the previous test it was stripped down, examined, the fault was rectified and re-assembled. When satisfied with each channel performance, the Fluidic device mounting plate, item L, was fitted on top of the mounting feet and the fluidic devices were connected to the Polythene Supply Block signal pipes.

6.2.6. Performance of the Tape Programme Unit

The equipment and method used to test the unit, was similar to that used for testing the Rotary Programme Unit, described in Chapter 6.2.1. An input supply of 60 inches water gauge was connected to the Polythene supply block, the back pressure and sensing device pipes to monometers. Back pressure readings between 40 to 46 inches water gauge were observed, when the sensing unit probe covered the sensing device orifice. When the probe moved, and allowed the device to vent to the atmosphere, the back pressure signal dropped to 16 inches

water gauge, giving a differential of 30 inches water gauge to switch fluidic devices.

Each channel was tested in turn, the other channels being programmed to zero in order to eliminate feed back and the observation of circuit resistance. The selected results, listed below, are typical, with the exception of the odd high back pressure from an open sensing device, marked x. Examination showed that partial blockage of the traverse groove with bonding agent had occurred. On completion of the test and recording the results in Table 1 the channel back pressure pipes were connected to a manifold enabling a common back pressure signal pipe to be fitted. This would permit a feed back to the unprogrammed channels and effect the results listed in Table No. 1. With an air supply of 60 inches water gauge, Channel number 6 was programmed to a sensing device, which on the previous test, had given water gauge readings of:-

Back pressure, sensing device orifice open -	16 inches
Back pressure, sensing device orifice closed -	46 inches
Sensor pressure	- 40 inches

The common back pressure signal pipe was connected to the monometer and comparative readings were taken to observe the effect of feed back into the Programme Unit. The remaining channels, which had been set at zero, were then programmed in turn until a complete operational selection was on the Tape Programme Unit. The results of this test are listed in Table No. 2.

TABLE No. 1

Supply Pressure

60 inches water gauge

Back Pressure Readings. inches water gauge		
Programme at Zero	Sensor open	Sensor closed
Channel No. 1 50 inches	14	38
	12	38
	≠ 20	40
	12	36
	14	34
Channel No. 2 38 inches	≠ 20	36
	12	34
	≠ 22	32
	10	31
	16	34
Channel No. 3 50 inches	10	43
	12	34
	12	46
	≠ 26	44
	8	40
Channel No. 4 38 inches	10	30
	10	28
	12	28
	9	32
	8	30
Channel No. 5 46 inches	12	26
	9	26
	14	32
	≠ 22	34
	12	32
Channel No. 6 48 inches	10	46
	11	44
	≠ 20	42
	10	46
	16	36

TABLE No. 2 Supply Pressure 60 inches water gauge.

Number of Channels Programmed	Back Pressure Readings. inches water gauge	
	Sensor Open	Sensor closed
1	6.0	10
2	5.0	7.4
3	4.0	5.5
4	3.8	4.5
5	3.5	4.0
6	3.2	3.4

The back pressure signal decreased in strength as each channel was programmed to a sensing device. When the travelling probe of the sensing unit passed any programmed sensing device, the back pressures of all channels increased slightly; the largest increase in pressure occurred when the energised channel sensing device was covered by the travelling probe. The air supply to each channel was at this stage, provided by a three port diaphragm operated valve with a plug in the exhaust port. This arrangement prevented a drop in any channel pressure, as a feed back through the back pressure signal manifold into the unactivated channels, would exhaust to atmosphere through the valve exhaust port. The back pressure signal from the Programme Unit was now less than 10% of the individual channel performance. The supply pressure was increased to 10 inches of mercury, approximately 500%, but this only gave a 150% increase in back pressure signal strength. At this higher pressure the test was repeated, and the results tabulated in Table No. 3.

When the travelling probe of the sensing unit traversed over a programmed sensing device of an unactivated channel, the feed back from the common back pressure signal manifold, was sufficient to effect the back pressure signal.

TABLE No. 3

Supply Pressure

10 inches. Mercury.

Number of Channels Programmed	Back Pressure Readings. inches water gauge	
	Sensor Open	Sensor Closed
1	15.7	25.4
2	10.4	16.5
3	9.4	14.8
4	8.0	11.5
5	6.6	9.2
6	5.8	8.1

The programmed sensing devices chosen in the previous tests were used, and fluctuations in the back pressure signal strength as the probe passed each programmed sensing device were noted in Table No.4.

TABLE No. 4

Supply Pressure

10 inches. Mercury.

Sensing Device Position	Un-activated Channels						Activated Channel
	0	1	2	3	4	5	6
Back Pressure inches water gauge	5.8	6.6	6.1	6.3	6.8	6.3	8.1

Several tests were made with varying programmes, the results in each instance being similar to the above. The recorded pressures were taken after the water column of the monometer had stopped oscillating. Surge readings were in several instances, greater than sensor position No. 6 in the above table and caused the fluidic device to switch.

The diaphragm valve exhaust plugs were removed and any feedback from the back pressure signal manifold, exhausted to atmosphere, through valves not activated. This permitted the supply to "bleed off"; the operating pressure dropped to 6.5 inches of mercury, but was adjusted back to 10 inches before the above programme was tested under this varied condition. The results noted in Table No. 5.

TABLE No. 5

Sensing Device Position	Un-activated Channels						Activated Channel
	0	1	2	3	4	5	6
Back Pressure. inches water gauge	5.0	5.0	5.1	5.1	5.1	5.1	6.4

The overall back pressure signal strength was now reduced from 8.1 to 6.4 inches water gauge. The variation as the probe passed the sensing devices, was from 1.0 to 0.1 inches water gauge, but the surge readings were negligible, and could not be noted with any degree of accuracy, although air consumption had increased.

The Tape Programme Unit for feed, speed and collet operation does not require the back pressure signal arrangement; the programmed selection is connected to a "Nor" gate or a similar fluidic device. When tested with a supply pressure of 10 inches of mercury, the output was 6.5 inches, giving an efficiency of 65% where as the fluidic devices were approximately 20%. The seal between the tape, the polythene supply block and the unit base proved to be satisfactory but movement of the tape tended to be sticky due to the contact pressure. Impregnation of the polythene supply block tape contact face with graphite, allowed the tape to slide more easily when the driving sprocket was rotated.

6.2.7. Alterations to the Back Pressure Signal Arrangement

The back pressure signal pipes from each channel supply block were connected to a back pressure manifold, fitted onto the unit pressure plate, to give a common output pipe as shown in Figure 52. The various tests had shown that this arrangement was inefficient due to feed back. Variation in channel and sensor output, due to the method of manufacture causing partial blockage of grooves, was considerable. The differential pressure was, however, still sufficient to switch the output of a Schmitt Trigger. By using one fluidic device per channel adjusted to suit that channel operating pressure; six devices were necessary instead of one, but the feed back problem was eliminated. Back pressure signal strengths were now comparable with those obtained in the individual test. A wider switching differential pressure band, about 10 inches water gauge instead of 1.3 inches water gauge, was now available and it

reduced the possibility of a malfunction occurring. The Tape Programme Units were subsequently fitted into the Control Panel, as shown in Figures 62 and 63; replacing the Rotary Programme Units.

6.3. Performance of the Address System

The Address System functioned in a satisfactory manner when tested manually. A satisfactory range of turret slide feeds could be obtained by adjusting the flow control valves, but the quick traverse motions were slower than anticipated due to pipe and valve restriction on fluid flow.

6.3.1. Valve Response

It was found that certain diaphragm valves required a minimum pressure 50% higher than specified before they would operate. In some instances, the delay in response was several seconds. When the diaphragm valve operating pressure was increased to 3.0 pounds per square inch the performance coincided with that specified for a diaphragm pressure of 2.0 pounds per square inch. As the air supply to operate the valves was the output of fluidic devices, it was necessary to increase the fluidic supply pressure, which in turn affected air consumption. This type of valve was purchased some time ago for the project, although since that date, alternative designs have become available, which operate on much lower pressures.

6.4. Performance of the Logic System

Performance of the individual fluid logic devices used in the various circuits were comparable with the manufacturers specification. When assembled on mounting boards, interference and malfunction did occur in some instances and it was necessary to re-arrange the devices. When a circuit did not function correctly, the cause was either a loose signal pipe which had been accidentally removed; an obstruction in the device airways, usually dust, or a fluctuation in manifold pressure. Finding the blocked airway in a completed circuit was time consuming, as each pipe had to be removed, but easily cleared with an air blast. The fluctuation in air supply pressure to the devices, was caused by the Count Circuit changing the air supply to the various Programme Unit Channels. It was necessary to introduce a separate supply for the Programme Units as the rapid fluctuation caused some devices to oscillate. The increase in diaphragm operating pressure of the Address System valves, made it necessary to re-arrange the fluidic air supply. In general, most of

CONTROL PANELS.

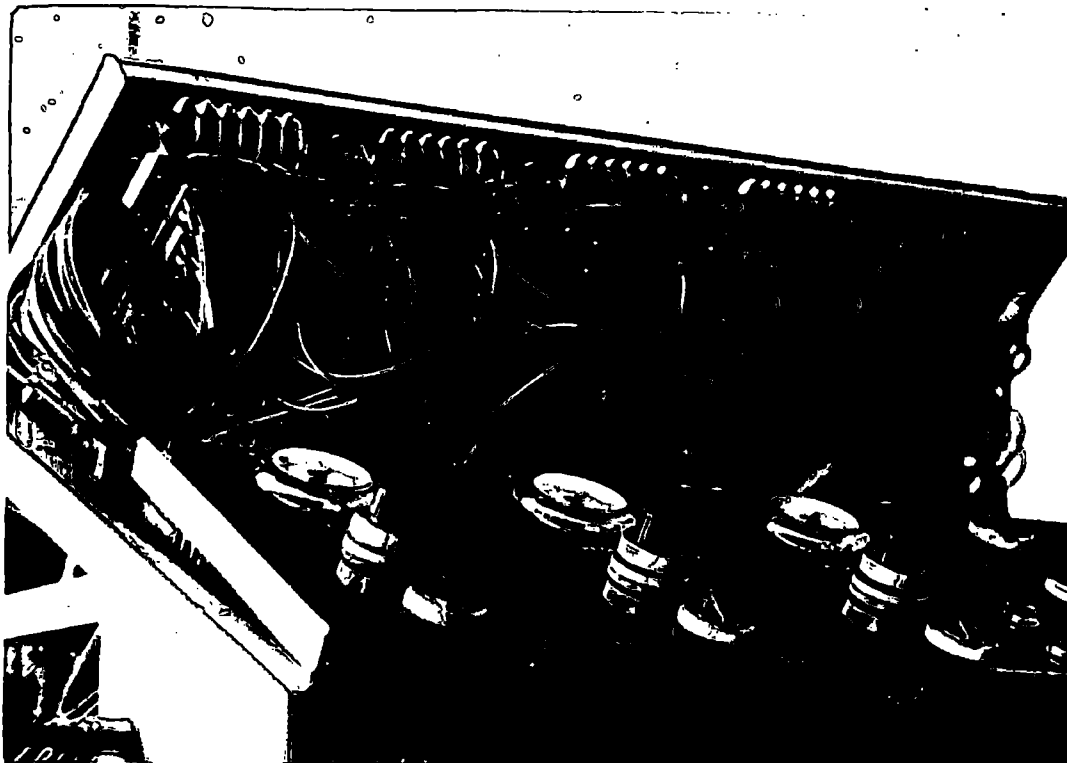

FIG 62

CONTROL PANELS.

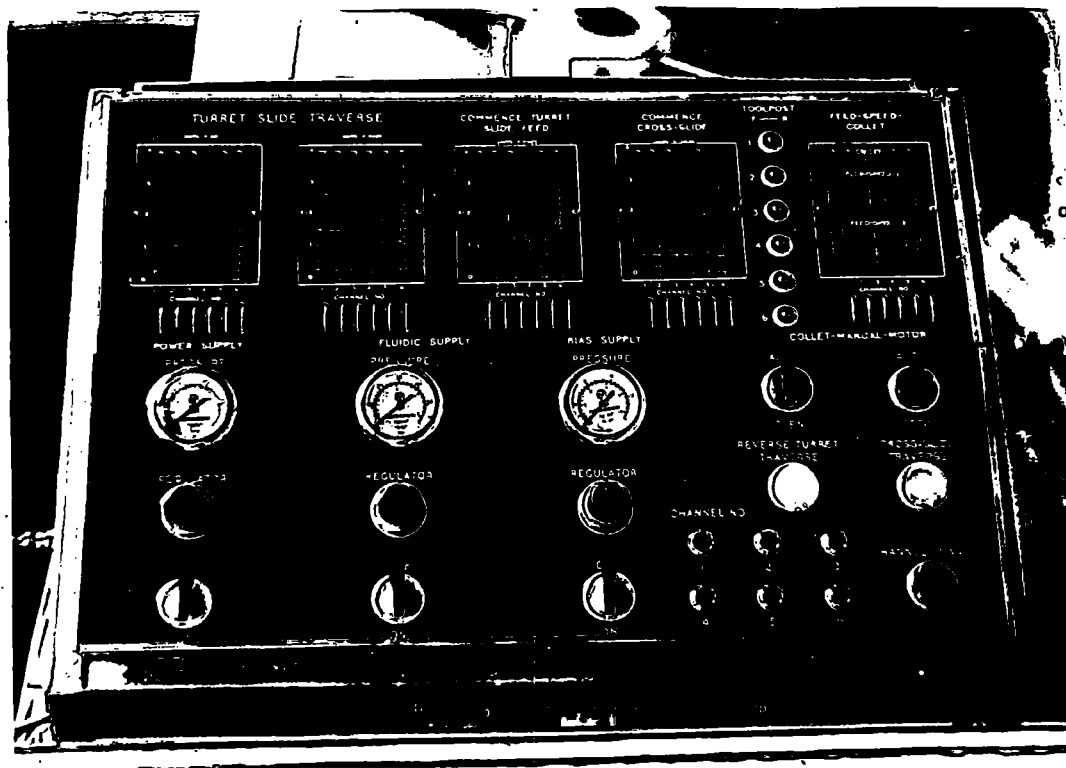

FIG. 63.

the problems encountered were due to inexperience in fluidic circuitry and application, with this number of devices mounted in close proximity.

6.4.1. Modifications to the Fluidic Logic Air Supply

From the data available on fluidic devices, the performance characteristics appeared to be compatible, and each functional circuit was supplied with air from a common manifold. The manifold pressures were determined by device efficiency, and the output pressure necessary to activate the diaphragm valves in the Address System. On increasing the manifold pressure to give a higher device output, now necessary to activate the valves, certain devices operating on or about the maximum recommended pressure, started venting and their performance was affected. The supply in each circuit was subsequently divided, devices activating valves were supplied from a high pressure manifold, those concerned with logic, from a low pressure manifold.

6.4.2. Logic Device Malfunction

Malfunction of the fluidic devices was due to one, or a combination of the following:-

- I. An excessive input supply pressure overloading the device and the surplus was "dumped" by venting to the atmosphere. When the vents of adjacent devices were close together and in line, the "dumped" air could switch the adjacent device: in some instances an oscillating action occurred. A typical example of such a fault occurred in the Channel Selection circuit, Figure 10, which was originally supplied with air at a pressure of 10 pounds per square inch. When the supply was reduced to between 5 and 7 pounds per square inch; dumping and oscillation ceased.
- II. A control signal of insufficient magnitude, either in pressure or duration would not switch the device it controlled. The ten millisecond output signal from a multivibrator, could not be used to provide the count signal for a Binary Counter, as this device required a signal duration of at least 10 milliseconds. This factor, the Multivibrator output characteristics, and capacitance of signal pipes, made it necessary to modify some fluidic circuits. Maximum fan-out is limited to four devices; when connecting pipes were over eight

inches in length, the switching performance was marginal due to low control signal pressures. Malfunction usually occurred on the device fitted with the largest control signal pipe. In such cases, control pipes of a common length were fitted to balance resistance; the fan-out restricted to three devices, or a Digital Amplifier, was incorporated in this circuit.

6.4.3. Modifications to the Fluidic Circuits

Modifications to several circuits were necessary due to the factors mentioned in Chapters 6.3.1., 6.4.1., 6.4.2.; the introduction of the Tape Programme Units, back pressure signal modifications, and the combined feed, speed, collet programming.

- I. The Channel Selection circuit, Figure 10, devices were re-arranged due to venting, the count signal C1 was not 40% of the Binary Counter supply and a Back Pressure Switch was fitted. The supply to the Nor gates had been increased to operate the diaphragm valves, but the output of Nor gate N6 was not sufficient to control valve 23 and the And gate A1. It was necessary to incorporate Digital Amplifier DA1 into the circuit to increase the output. The revised circuit, shown in Figure 10 - 2 was built and tested; its performance was satisfactory.
- II. The cross-slide fluidic circuit, Figure 11, did not function correctly due to a continuous output signal from ST1 locking the Bistable B1 output to O1. This allowed the cross-slide to move from position A to C, but prevented the pulse signal from C switching B1 output to O2 and reversing the slide motion. Manual removal of ST1 locking control signal permitted reversal of slide motion to activate the Multivibrator MV1, confirming that the pulse output signal, would not operate Binary Counter BC1, which controlled the valve operation through the Digital Amplifier DA1. In addition to the critical setting of restrictors in the sensing device pipes from positions A, B, and C; the control signals marked Front and Rear, C1 and C2 of Schmitt Trigger ST1 from a manifold block, were very weak.

CHANNEL SELECTION FLUIDIC DIAGRAM

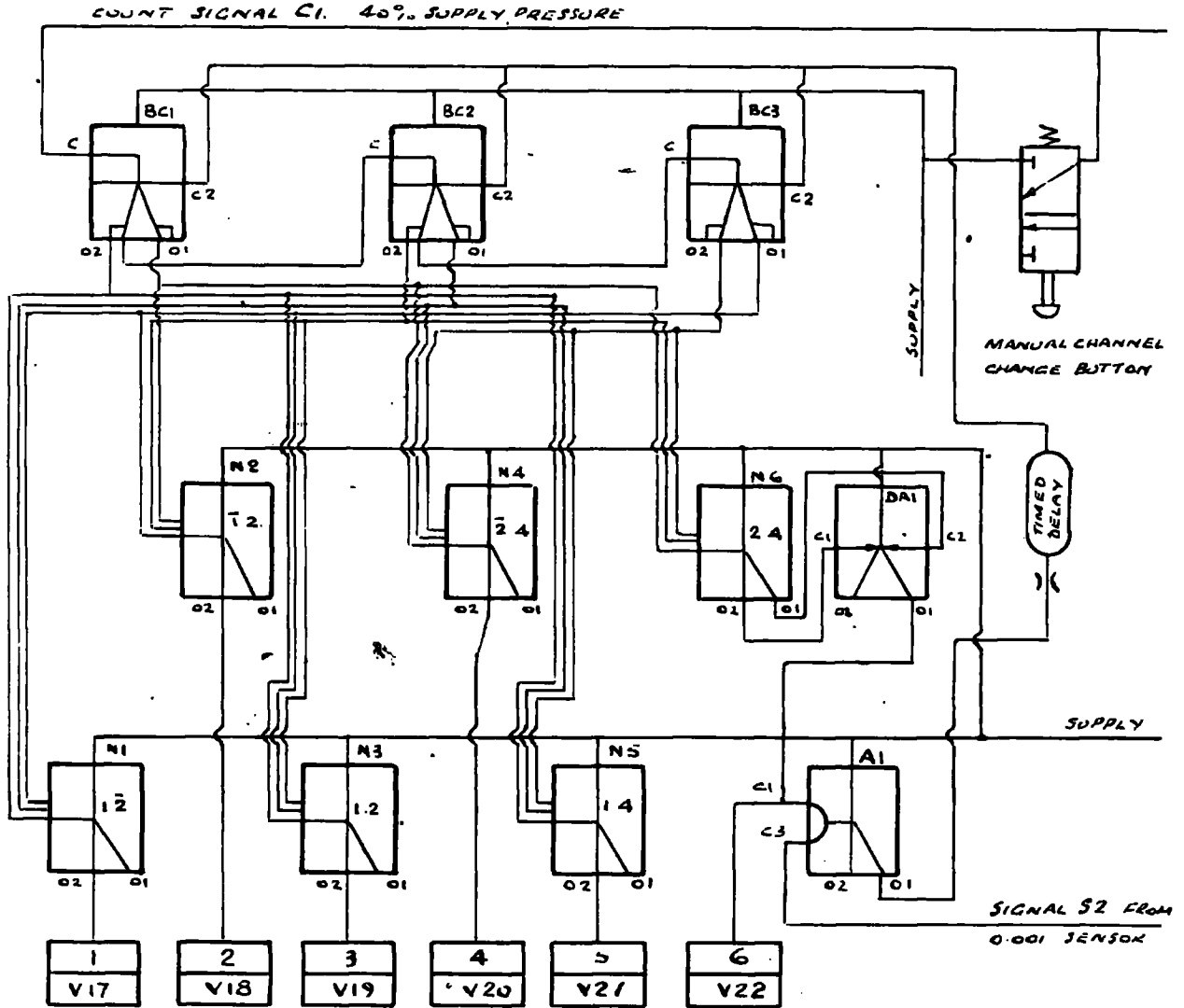

TRUTH TABLE

CHANNEL N°	BC1				BC2				BC3				N1		N2		N3		N4		N5		N6		DAI SENSOR	AI			
	C	01	02	C2	C	01	02	C2	C	01	02	C2	01	02	01	02	01	02	01	02	01	02	01	02		01	02		
0	0	0	1	1	0	0	1	1	0	0	1	1	1	0	1	0	1	0	1	0	1	0	1	0	5	0	1	0	1
1	1	1	0	0	0	0	1	0	0	0	1	0	0	1	0	1	0	1	0	1	0	1	0	1	5	0	1	0	1
2	1	0	1	0	1	1	0	0	0	0	1	0	1	0	0	1	1	0	1	0	1	0	1	0	5	0	1	0	1
3	1	1	0	0	0	1	0	0	0	0	1	0	1	0	1	0	0	1	1	0	1	0	1	0	5	0	1	0	1
4	1	0	1	0	1	0	1	0	1	1	0	0	1	0	1	0	1	0	0	1	1	0	1	0	5	0	1	0	1
5	1	1	0	0	0	0	1	0	0	1	0	0	1	0	1	0	1	0	0	1	1	0	1	0	5	0	1	0	1
6	1	0	1	0	1	1	0	0	0	1	0	0	1	0	1	0	1	0	1	0	1	0	0	1	5	1	0	1	0

SIXTH COUNT AND SIGNAL FROM SENSOR RESET BINARY COUNTERS TO ZERO

FIG 10-2

CROSS-SLIDE FLUIDIC CIRCUIT.

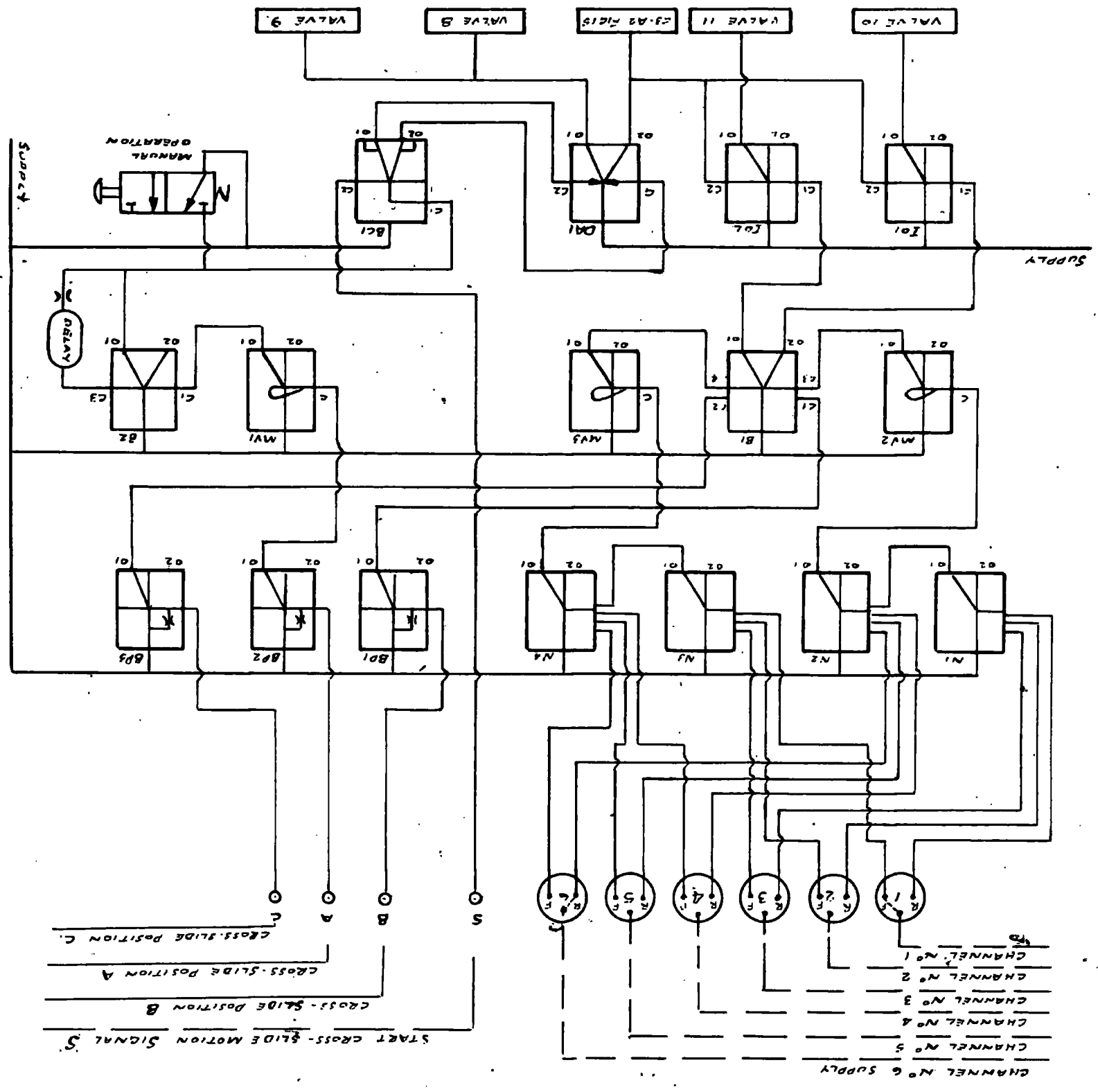

OPERATION	CHANNEL	N1	N2	N3	N4	N5	MV 1	MV 2	MV 3	BI	I01	I02	DA1	VALVES	BP1	BP2	BP3	MV	B2	BC1	
STOP CENTRAL	R	0	0	0	0	0	0	0	0	0	0	0	0	0	0	0	0	0	0	0	0
PROGRAMME SENSOR SET TO MOVE	R	0	0	0	0	0	0	0	0	0	0	0	0	0	0	0	0	0	0	0	0
FRONT TOOL OPERATION POSITION A TO B	F	0	0	0	0	0	0	0	0	0	0	0	0	0	0	0	0	0	0	0	0
REVERSE MOTION RETURN CENTRAL B TO A	F	0	0	0	0	0	0	0	0	0	0	0	0	0	0	0	0	0	0	0	0
STOP CENTRAL	F	0	0	0	0	0	0	0	0	0	0	0	0	0	0	0	0	0	0	0	0
PROGRAMME SENSOR SET TO MOVE	R	0	0	0	0	0	0	0	0	0	0	0	0	0	0	0	0	0	0	0	0
REAR TOOL OPERATION POSITION A TO C	R	0	0	0	0	0	0	0	0	0	0	0	0	0	0	0	0	0	0	0	0
REVERSE MOTION RETURN CENTRAL C TO R	R	0	0	0	0	0	0	0	0	0	0	0	0	0	0	0	0	0	0	0	0
STOP CENTRAL	R	0	0	0	0	0	0	0	0	0	0	0	0	0	0	0	0	0	0	0	0

FIG. 11-2

FEED SELECTION FLUIDIC DIAGRAM.

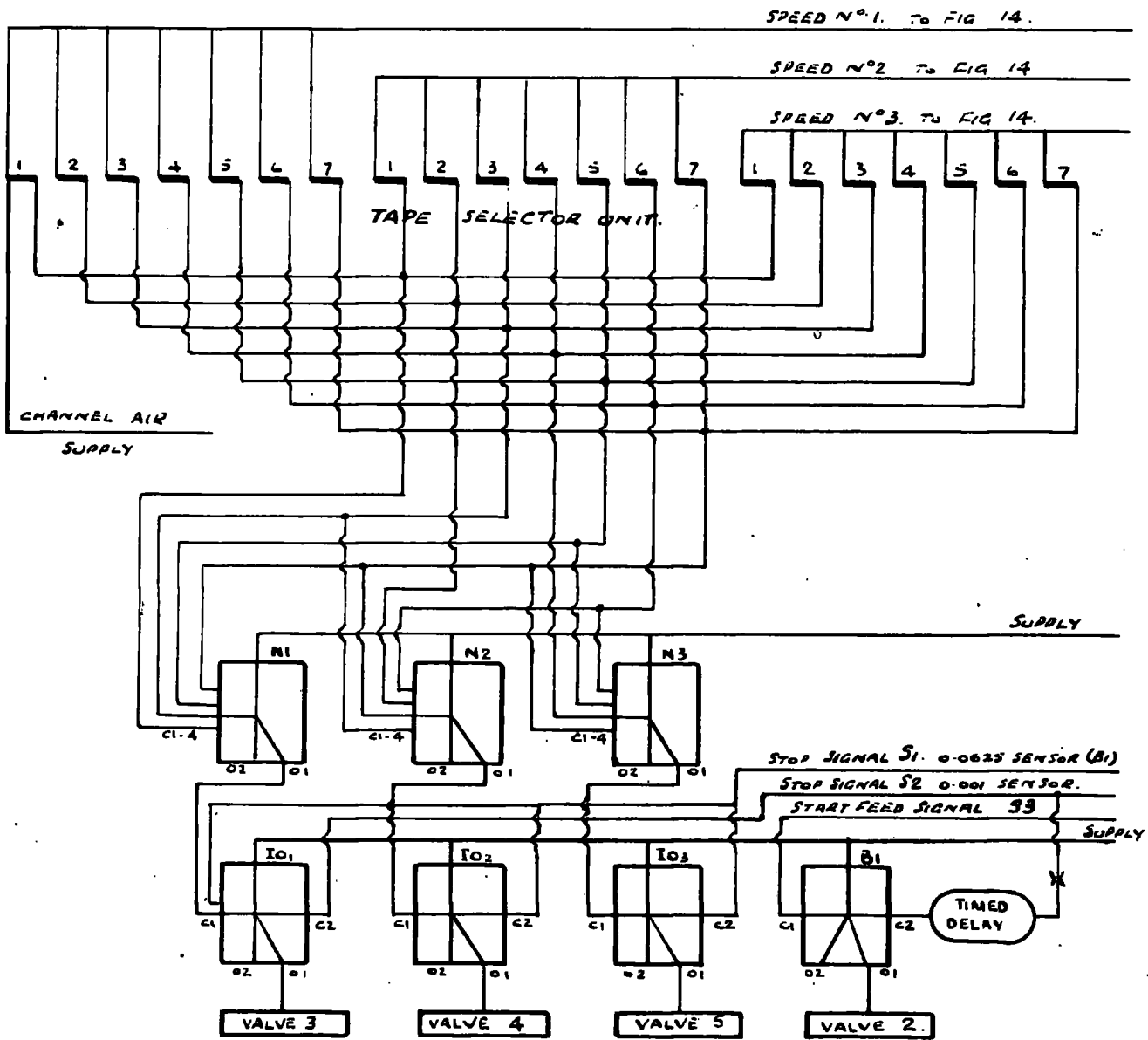

TRUTH TABLE.

TURRET OPERATION	TAPE PROGRAMME SECTOR.							N			IO1		IO2		IO3		B1		SIGNAL			VALVE				
	1	2	3	4	5	6	7	1	2	3	O1	O2	O1	O2	O1	O2	O1	O2	S1	S2	S3	2	3	4	5	
INDEX, SELECT FEED, QUICK TRAVERSE	SELECTED BY							1	1	1	1	1	0	1	0	1	0	0	1	0	0	0	0	1	1	1
START FEED.	PROGRAMME.							1	1	1	1	1	0	1	0	1	0	1	0	0	0	1	1	1	1	1
CREEP FEED								1	1	0	0	1	0	1	0	1	1	0	1	0	1	1	1	1	0	0
STOP TRAVERSE								1	0	0	0	0	1	0	1	0	1	1	0	1	1	1	1	0	0	0
REVERSE TRAVERSE								1	1	1	1	1	0	1	0	1	0	0	1	0	1	0	0	1	1	1

FIG. 12-2.

Increasing their strength caused a drop in pressure at the sensing unit and created feed back signal problems. The revised circuit, Figure 11-2, shows the various modifications; Back Pressure Switches BP1, BP2 and BP3 replacing the restrictors to improve the response and reliability of signals A, B and C. A Bistable B2, with a time delay reset, was introduced between MV1 and BC1 to increase the duration of control signal C to BC1. To overcome the problems related to ST1, six small switches were manufactured, inserted in the circuit, and programmed for front and rear toolpost operation. Feed back pressure signal loss was prevented by connecting the switch outputs to Nor gates, which supplied the control signals to MV2 and MV3. A pulse signal from either multivibrator, setting the output of B1, but allowing a signal from either position B or C to switch its output and reverse the cross-slide motion.

III. The Feed Selection fluidic circuit functioned satisfactorily, but with the introduction of the Tape Programme Units which have a higher output signal pressure than the Rotary Programme Units; Nor gates N1 to N7 were not necessary. As only seven selections were required for feeds, two for speeds, and one to operate the collet, it was decided to utilise one Tape Programme Unit. The revised circuit and Programme Unit connections are recorded in Figure 12-2.

IV. The Selector Switchboard fluidic circuit, Figure 13, which detected and amplified back pressure signals from the Sensing Units was basically operational. Malfunction occurred due to a feed back between the channels of the back pressure signal, and foreign matter restricting airways in the Programme Units. In the revised circuit diagram, now referred to as the Tape Selection Unit fluidic diagram, Figure 13-2, a Schmitt Trigger has been incorporated for each channel. This arrangement allowed a bias signal pressure to be selected for each channel condition, and increased the differential pressure range to prevent malfunction because of surge in manifold pressure. The manufacture of a Tape Programme Unit under improved manufacturing conditions, would give a more uniform channel output pressure, eliminate the problems encountered, and the original circuit would be satisfactory. By connecting the Schmitt Trigger outputs to two Nor gates, the channel feed back problem was removed; if a six input device had been

TAPE SELECTOR UNIT FLUIDIC DIAGRAM

LENGTH 0.001 IN TAPE SELECTOR

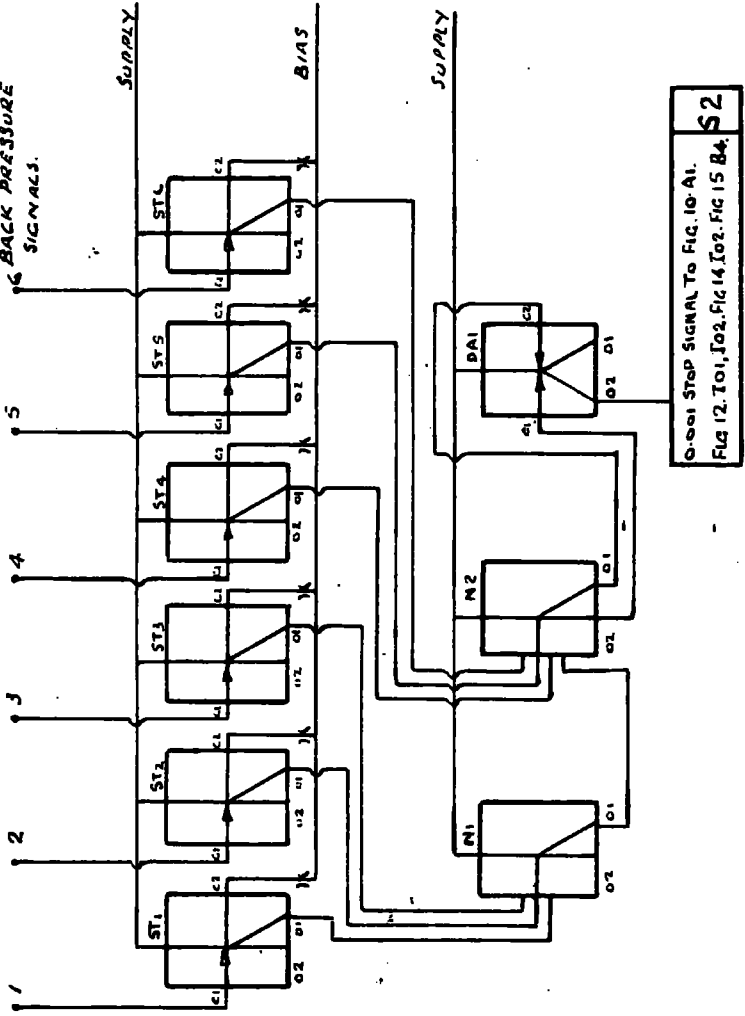

LENGTH 0.0625 IN TAPE SELECTOR

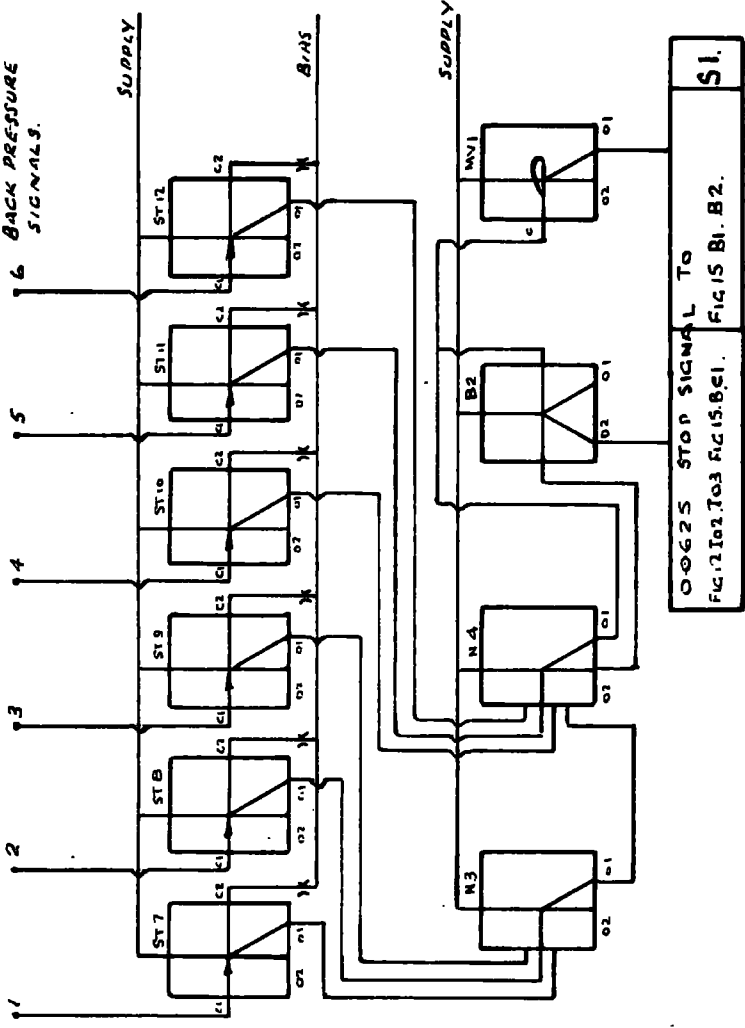

START FEED TAPE SELECTOR

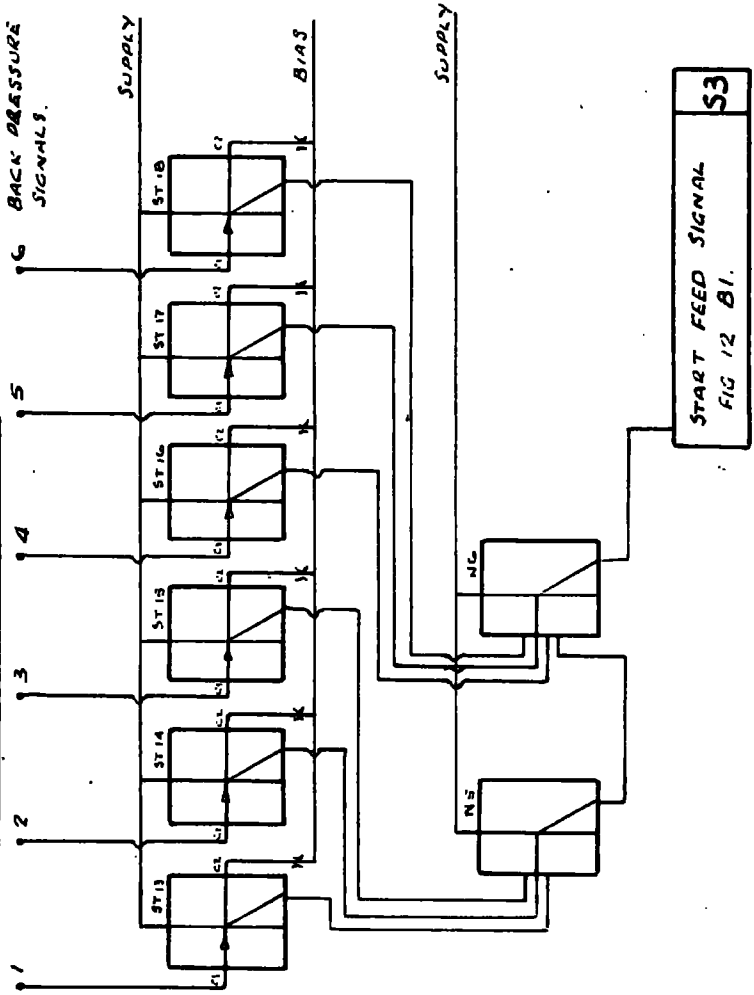

START CROSS-SLIDE TAPE SELECTOR

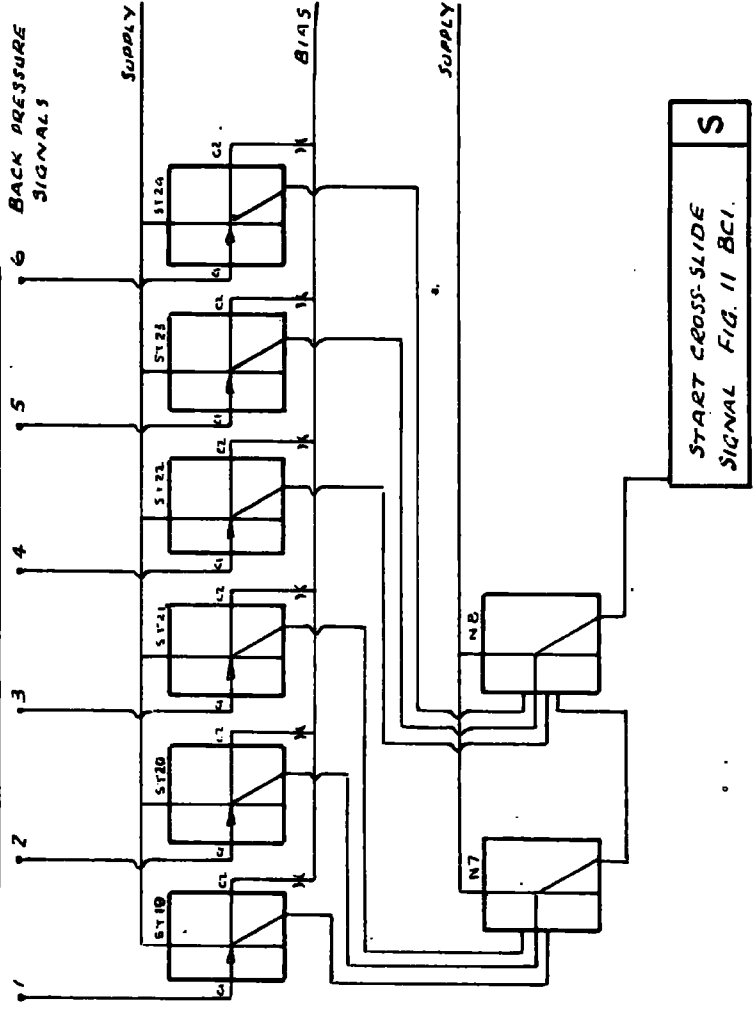

available, only one Nor gate would have been introduced into the circuit. This arrangement of six Schmitt Triggers and two Nor gates, was incorporated in all Tape Programme Unit Circuits connected to the 0.0625 and 0.001 inch Sensing Units, and provided signals S, S1, S2 and S3.

- V. The Valve Control Fluidic diagram, Figure 15, was modified as shown in Figure 15-2 and now includes two Back Pressure Switches in place of the Back pressure restrictors. The Back Pressure Switches improved the response and strength of signals C1 and C2, which were weak because of the length of signal pipe; they also removed the need for the Schmitt Trigger ST1.

6.4.4. Completion of Assembly

Each fluidic circuit after assembly and testing, had been stored until final assembly into the Control Cabinet, when connections between the Logic, Address and Programming Systems were completed. When the system was energised it did not function; the various sub-assemblies which had operated satisfactorily when bench tested did not perform their task. The initial failure was due to the following:-

- I. Dust had accumulated in some manifolds and pipes causing the fluidic devices to malfunction.
- II. The increase in pressure to devices controlling the diaphragm valves, overloaded the capacity of certain supply pipes and manifolds.
- III. Air flow to the fluidic circuits was not balanced, the supply pressure varied due to pipe size, length and circuit requirements. As a result, the output from some devices was low and would not switch devices they controlled. The performance of each fluidic device was tested, each faulty control signal traced, blocked devices removed, cleaned, refitted and the circuit then re-tested. The air supply to the manifolds was re-arranged, additional or large bore piping was introduced to increase air flow, and individual circuit supplies were balanced. At this stage it was realised that a common supply manifold does not guarantee a uniform circuit manifold pressure. If flow control regulators had been

VALVE CONTROL FLUIDIC DIAGRAM.

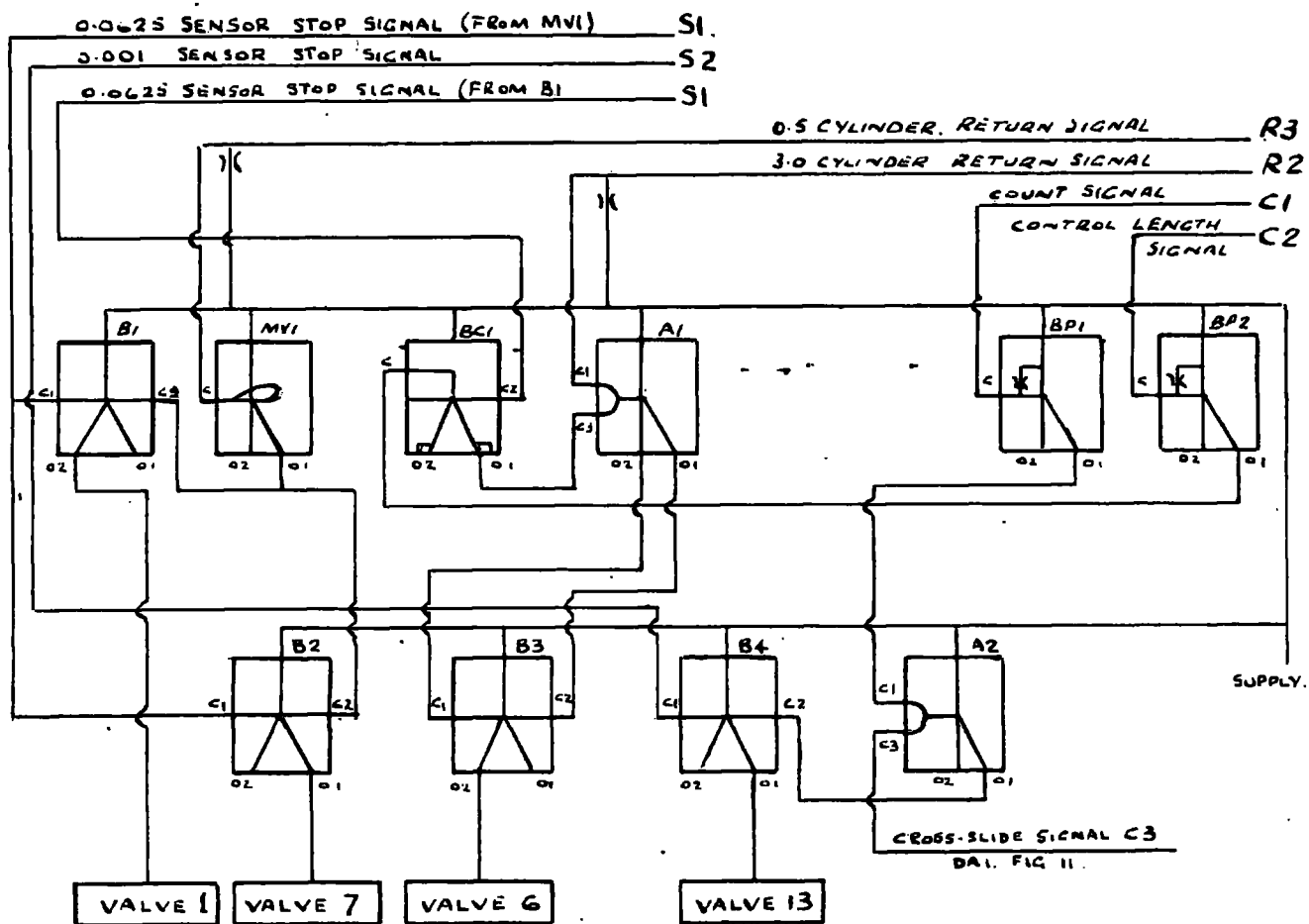

OPERATION	SENSOR SIGNAL	CONTROL VALVES.																			
		A2		B4		BC1		A1		B3		MVI		B1		B2		1	6	7	13
		01	02	01	02	01	02	01	02	01	02	01	02	01	02	01	02				
ALL CYLINDERS RETURNED	R3 R2 C2	0	1	1	0	1	0	1	0	0	1	1	0	1	0	0	1	To 3" SL	TANK RAM	3" SL RAM	AIR TANK
INDEX TURRET FORWARD TRAVERSE	R3 R2 C1	1	0	0	1	1	0	1	0	0	1	0	1	1	0	0	1	"	"	"	AIR RAM
CONTROLLED LENGTH RAM SIGNAL	R3 R2 C2	0	1	0	1	0	1	0	1	1	0	0	1	1	0	0	1	"	RAM T SLAVE	"	"
STOP 3" CYLINDER 0.0625 SENSOR	R3 S1	0	1	0	1	0	1	0	1	1	0	0	1	0	1	1	0	To 0.5" SL	"	0.5" SL RAM	"
STOP 0.5 CYLINDER 0.001 SENSOR	S2 S1	0	1	1	0	0	1	0	1	1	0	0	1	0	1	1	0	"	"	"	AIR TANK
REVERSE RAM AND 0.5 CYLINDER	R3	0	1	1	0	0	1	0	1	1	0	1	0	1	0	0	1	To 1.3" SL	"	3" SL RAM	"
REVERSE RAM AND 3" CYLINDER	R3 R2	0	1	1	0	0	1	0	1	1	0	0	1	1	0	0	1	"	"	"	"
CONTROLLED LENGTH RAM SIGNAL	R3 R2 C2	0	1	1	0	1	0	1	0	0	1	1	0	0	1	1	0	"	TANK RAM	"	"
INDEX TURRET (CHECK)	R3 R2 C1	1	0	0	1	1	0	1	0	0	1	0	1	0	0	1	1	"	"	"	AIR RAM

FIG. 15-2

included in each fluidic circuit supply, tuning the various circuits would have been relatively easy. The various modifications have been incorporated in a revised Schematic Arrangement of Pneumatic-Hydraulic Fluidic Circuits Diagram, Figure 18-2. The re-arrangement of fluidic devices, Tape Programme Units and simulator are illustrated in Figure 62, 63, 64, 65 and 66.

Schematic Arrangement of Pneumatic-Hydraulic-Fluidic Circuits

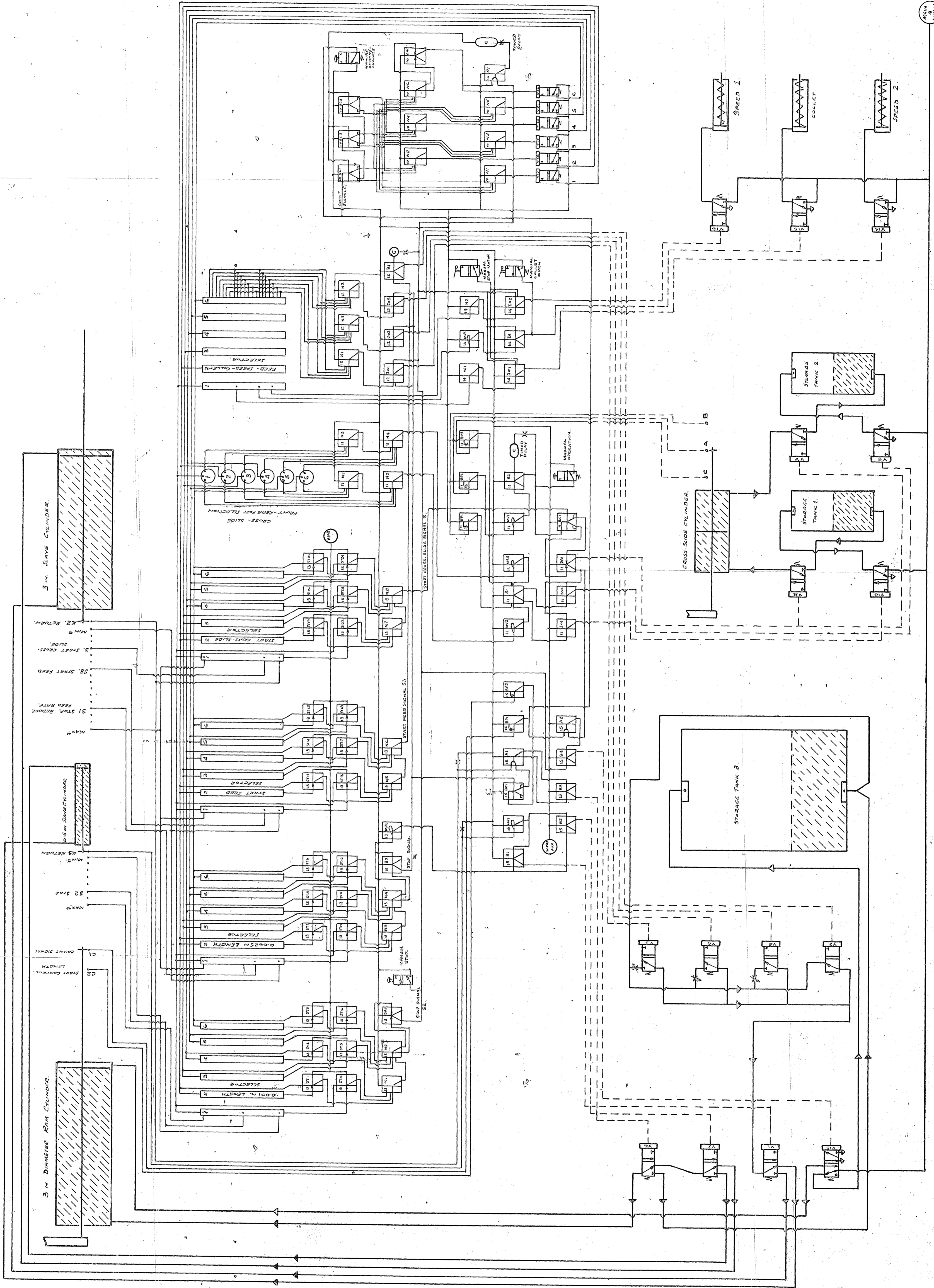

CONTROL SYSTEM AND SIMULATOR.

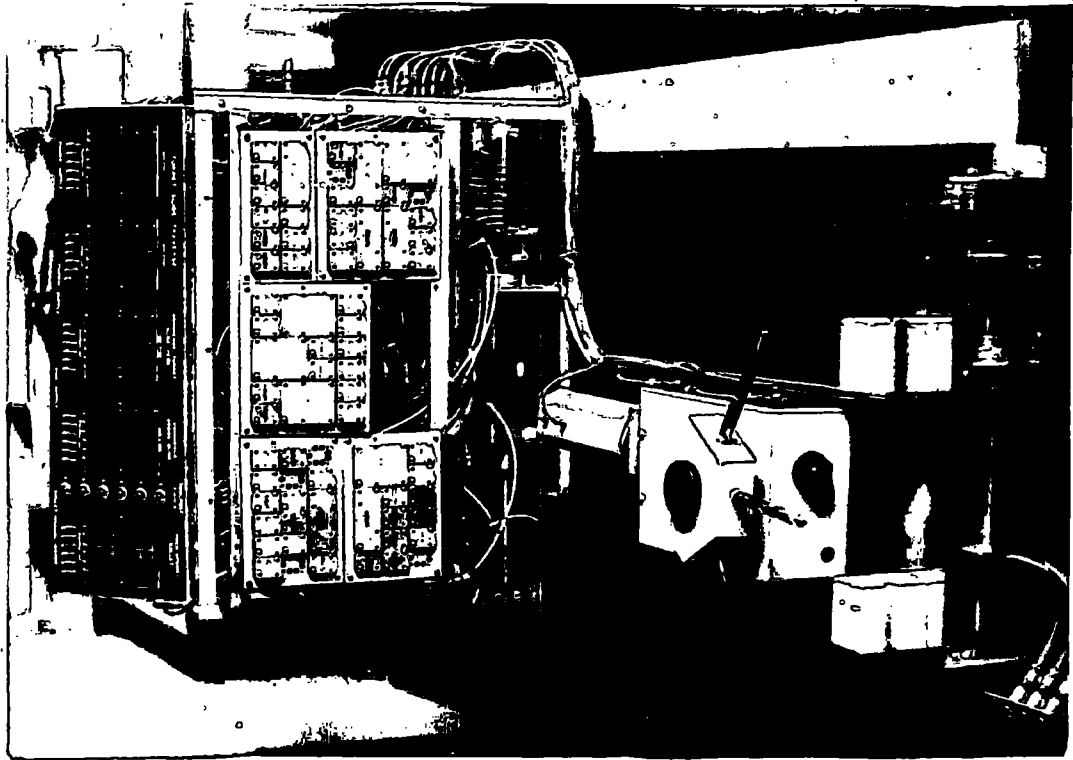

FIG 64.

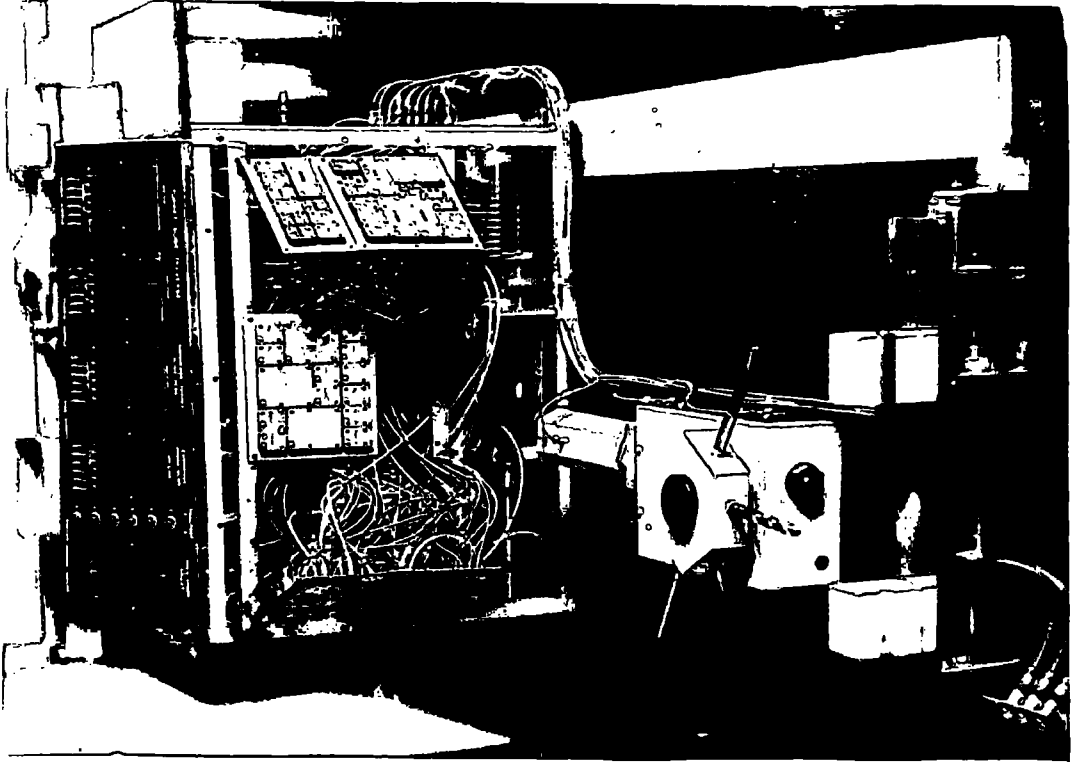

FIG. 65

CONTROL SYSTEM AND SIMULATOR.

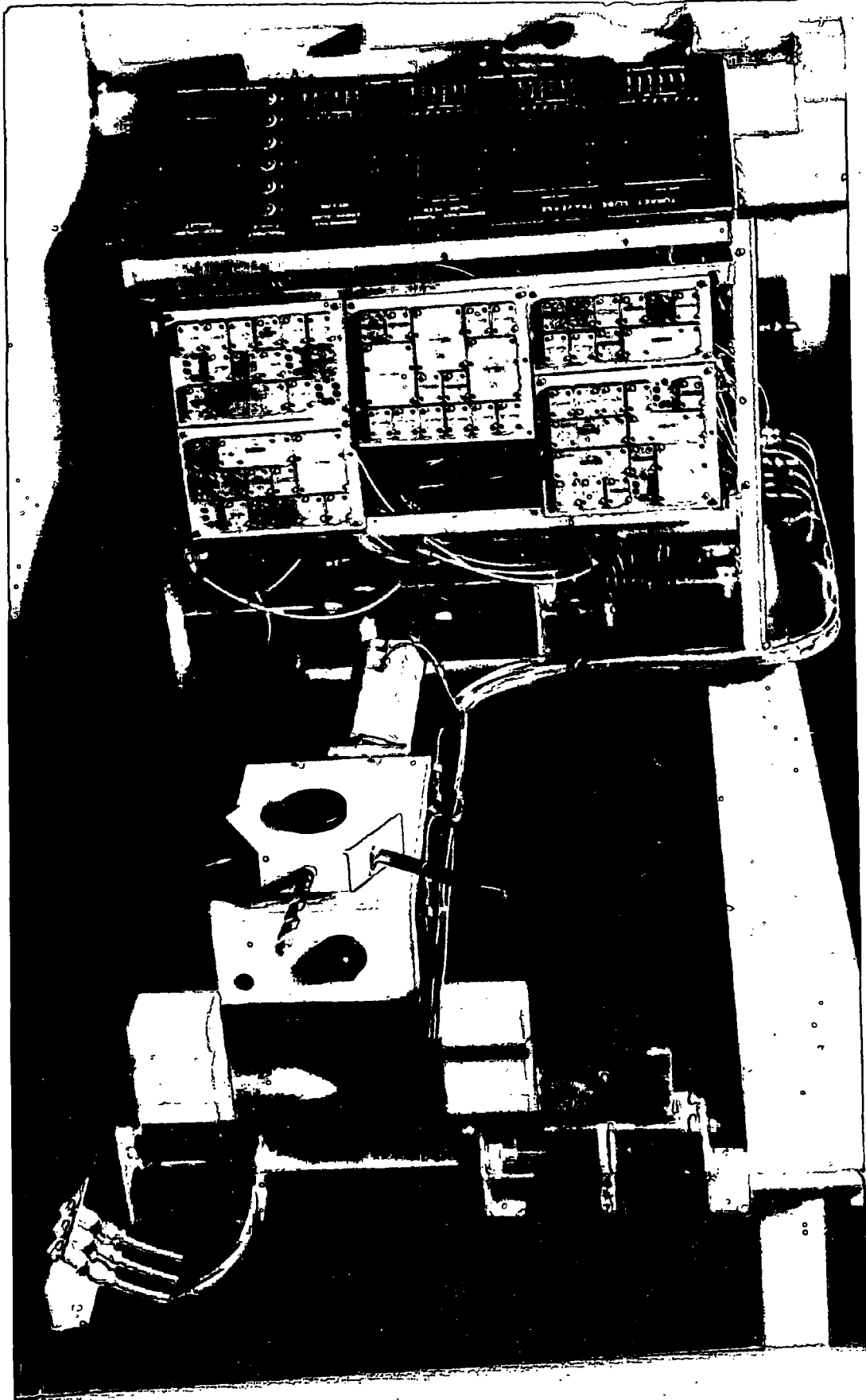

FIG. 66.

CHAPTER VII

Conclusions

In concluding this thesis, it is appropriate to make general observations in the following areas:-

- I Manufactured components.
- II Programming.
- III Hydraulic application of linear motion.
- IV Performance of the fluid logic devices.
- V Construction of the circuits.
- VI Air supply.
- VII Performance of the control system.
- VIII Fault finding.
- IX Performance of fluidic systems.
- X Modifications to improve performance.
- XI Future additions to the control system.
- XII Cost.

7.1. Manufactured Components

With the exception of the Programme Units, no problems were encountered in the manufacture or performance of such items as, Storage Tanks, Manifolds and Sensing Units. The performance of the Programme Units was disappointing and the variation in each channel output, had a serious effect on the systems' overall performance. Approximately 40% of the Programme Channels conformed to the design specifications, 40% gave marginal performance and the remainder, were of little use. The cause of such a variable performance could be attributed to the manufacturing techniques, or materials used in converting the basic design into a working unit.

7.2. Programming

The operational performance of the Rotary Programme Unit was a failure because of signal leakage, and as facilities were not available to manufacture the suggested modifications, shown in Figure 58, the alternative Tape Programme Unit was developed. Performance of these units varied considerably, but they were

functional and it was possible to programme the system. Had such processes as photo-etching, high frequency plastic welding, moulding equipment, and a suitable range of plastic and rubber compounds been available, a more uniform and improved performance would have been possible.

Cursor lines were used to position the Channel Dials and Endless Tape in line with the sensing device holes. When setting a programme, it was found that a combination of manufacturing tolerances and the angle an operator observed the lines, permitted a slight mis-alignment, which acted as a restriction and reduced signal strength. A programme read-out indicator panel, using the non-functional fluidic device output would be beneficial to the operator.

7.3. Hydraulic Amplification of Linear Motion

The principle of transferring the exhaust fluid from a 3.0 inch diameter cylinder, into an 0.5 inch diameter cylinder to amplify and control the linear movement of the larger cylinder, proved to be effective but was limited by piston speed and valve response time. The linear amplification, approximately thirty two to one, increased the small cylinder piston speed pro-rata. A one inch per minute turret slide feed moved the 0.5 inch diameter Slave Cylinder piston at a rate of thirty two inches per minute. With the existing sensing device orifice and probe bar dimensions of the 0.5 inch diameter Slave Cylinder Sensing Unit, a back pressure signal would have a duration of twenty milliseconds. The fluidic device characteristics would reduce this to a useful ten - twelve milli-second pulse signal. Owing to the response time of the valves changing the large cylinder programmed feed to a slow creep feed, ten to fifteen sensing devices of the 0.5 inch diameter cylinder Sensing Unit, could be passed by the probe, before the creep feed was fully operational. Using these sensing devices in a programme had a detrimental effect on repeatability.

At a sensing probe speed of thirty two inches per minute, the response time of the valves "locking" the circuit, permitted the probe to over-run the programmed sensing device. When the probe returned, a second "stop" signal was issued to the Logic circuit. A slower creep feed and wider probe bar was finally used in the repeatability tests. The use of a block probe, and operating the creep feed slightly before switching the fluid to the small slave cylinder, would permit faster creep feeds to be used.

7.4. Performance of the fluid logic devices

The performance of the devices was quite consistent and any variability could be traced to either a faulty connection, or foreign matter in the device airways. Malfunction of some devices did occur after an hour or so in operation, but when cleaned they functioned satisfactorily, without giving further trouble. It is advisable to clean with air, all pipes and manifolds prior to connecting up to the devices.

7.5. Construction of the Circuits

The experimental nature of this project dictated the method of connecting the outputs and control piping of the modules in the fluidic circuits. The modules were arranged in one plane to facilitate connections, and the length of some connecting pipes, especially from multivibrators, affected performance. The number of pipes and the compactness of the module layout did not facilitate either the assembly or testing. It was relatively easy to dislodge an output signal pipe or blanking-off plug from a triple output adapter.

The majority of restrictors used to give a timed delay, were a simple device which compressed the small bore piping. The adjustment proved to be coarse and required careful setting, where possible, they were replaced by a suitable fixed restrictor.

Insufficient attention had been given to the resistance of some of the hydraulic circuits, especially those containing several valves. This increase in resistance reduced the speed of the cylinder pistons, especially the quick traverse motion of the turret slide power cylinder.

7.6. Air Supply

The quality of the air used was similar to that available in any industrial organisation, with filters fitted to remove ring main pipe oxidation. On one occasion when bench testing a fluidic circuit, the supply was accidentally connected to an air line fitted with oil mist lubrication. Most of the oil passed through the devices or out of the vents and had no immediate effect on the simple devices, but the performance of the multivibrators and counters rapidly deteriorated. Eventually dust adhered to the oil coated vents, which affected the performance of all the devices and it was necessary to wash them in a solvent.

A fluctuation in the air supply pressure, due to the pressure regulating valve differential, had a serious effect on the performance of the Schmitt Triggers. A variation in the switching and bias control signal pressures altered the differential of the device and the switching characteristics were changed. This change was particularly noticeable on the Schmitt Triggers connected to the Tape Programme and Slave Cylinder Sensing Units. After setting the bias control signal pressures with restrictors, a variation in the supply pressure would either switch, or prevent the device from switching. Back Pressure Switches, a less sensitive device, were not affected by a variation in supply pressure, as their bias control is an internal connection from the device input. The Tape Programme Schmitt Triggers, which were not now reliable because of the supply pressure variation, were replaced by Back Pressure Switches. Where the Tape Programme channel had a good air seal, their switching characteristics were excellent, but on channels where leakage occurred, they would not switch.

A variation in the air supply pressure can seriously affect the reliability of a fluidic circuit, especially when Schmitt Triggers are incorporated, and it is now considered essential to fit a precision pressure regulator into the input supply.

7.7. Performance of the Control System

The overall performance of the control system was not good and could not be considered operational for the reasons which have been stated. It did confirm that fluidic sensing devices and hydraulic amplification could control linear motion within acceptable limits, for single point tooled machines. The method of programming sensing devices and the sequence of events, proved to be a relatively simple task when compared with plugboard and punched card systems.

7.8. Fault Finding

The location of a malfunction in a fluidic circuit could be laborious and tedious, as all control and output pipes had to be dis-connected. It was not only necessary to test for a block input or output passage in a device, but in many instances it was necessary to measure the signal magnitude as circuits operating at various pressures were inter-connected. Fluidic devices require a constant source of energy, and when an output is not used it is vented to the atmosphere. Using this feature to give an inverted read-out signal, the vented outputs were connected to a panel of

indicators, and the logic of a circuit of a circuit checked against the truth table. This technique could be extended to provide an incorporated fault finding panel.

7.9. Performance of Fluidic Systems

The use of fluidic devices has in general, been supplementary to fixed event pneumatic circuits. The number of devices utilised in such cases was relatively small and they were housed in one side of a double sided cabinet, the other side containing standard pneumatic equipment, such as filters and pressure regulators etc. Fluidics have proved to be extremely reliable in performance even when operating in humid, noisy or dusty environments. However, there are several disconcerting features, for example: when a circuit is energised there is no guarantee that it will always give a pre-determined pattern of device outputs so it would be advisable to incorporate a reset-start control. Another is the constant hiss of venting air, which can become irritating if the system operates in a quiet environment. The more sophisticated loop tape fluidic systems, now commercially available, successfully control a complex series of events, and permit a degree of flexibility in special purpose machine tool operation.

7.10. Modification to improve Performance

The modifications to this control system, which are necessary to make it fully operational, more efficient and reliable, have in some cases been discussed in previous chapters. They are:-

- I Precision pressure regulating valves to remove any air supply fluctuation causing unactivated switching of some fluidic devices.
- II The increase of the diameter of some hydraulic piping to increase cylinder piston speed on the non-working traverses.
- III Pneumatic-hydraulic valves, which will operate with lower diaphragm pressures to reduce the quantity of air required by the fluidic devices.
- IV The improvement of the Tape Programme seals.
- V The alteration of the 0.0625 inch distance Programme Unit and the Logic circuit to issue a pre-stop signal, which will start the creep feed.
- VI A block probe on the 0.001 inch distance Sensing Unit to prevent a double signal in the event of an over-run.

VII A fluidic interlock between the turret position and the programmed channel

The above modifications require no major alteration to the existing construction providing the valves are of a similar size. To make the system commercially acceptable, it should be re-designed to incorporate the following "additions" and utilise batch quantity manufacturing techniques.

7.11. Future Additions to the Control System

The Control System which has been constructed, when fully operational will serve the basic requirements of a capstan or turret lathe. Its operational effectiveness is limited, but extensions are possible by incorporating the following operations.

7.11.1. Coolant Supply

A common practice on automatic lathes is to enclose the tools in a transparent splash guard, and to provide a heavy continuous supply of coolant or lubricant to the cutting tools. This arrangement is not suitable for turret lathes owing to the use of boring bars and tooling arrangement. It is advantageous in many instances to have an individual coolant supply to the turret tools and another to the cross-slide tools.

The inclusion of a rotary switch, similar to those used to control front and rear cross-slide toolport operations, could be used to control the quantity of coolant. The start and stop signals from the Logic System being used to control the Coolant Supply valves.

7.11.2. "Woodpecker" Turret Slide Feed

When drilling holes there is a tendency for the drill flutes to become loaded with swarf, which may cause drill breakage; as it is difficult to flush away with coolant. When the hole is deep and the chip continuous, the length can be a safety hazard to personnel and foul machine and tools. A pause in the feed action, partial or full withdrawal of the drill giving it a "Woodpecker" action, breaks the swarf into manageable lengths and cleans the drill flutes.

Space is available on the Feed Programme Unit to incorporate this operation, but the continuous output signal would have to be converted, with a multivibrator, into a pulse output. This signal would set a bistable device and control the output of an inhibited OR gate which reverses the turret power cylinder motion. A timed

delay feed back signal from each output of the bistable device, would switch the reversing signal on and off, changing the direction of the slide movement. The "Woodpecker" action would continue until the stop signal S2, the inhibiting control of the inhibited OR gate, over-rides the timed delay signals and permits the turret slide to return and index.

7.11.3. Tapping Operation

When tapping holes, the direction of the spindle rotation must be reversed on reaching the desired thread depth to unscrew the tap as the slide reverses. Facilities to programme this operation can be incorporated in the Feed Programme Unit. The stop signal S2, which on the present system only stops spindle rotation to eliminate spiral tool marks on the component, would switch a bistable device to activate the reverse speed fluidic circuit. Controlled length signal C2 connected to the other bistable control, would switch the output and stop the reverse spindle rotation.

7.11.4. Cross-slide Front Toolpost Indexing

There are occasions when it is convenient to perform several operations with the cross-slide front toolpost, and it may be expedient to index the toolpost instead of using compound tools. To do this it will be necessary to fit an indexing cylinder to the toolpost and modify the small cross-slide rotary switches. Three output signal positions are now required on this switch, one for the rear toolpost operation, one for the front toolpost, and the third for indexing and front toolpost operation.

7.11.5. Interlocking Complimentary Systems

Provision must be made in the logic circuits to interlock this control system with such processes as automatic loading, unloading and gauging. This can be accomplished with the use of And gates and Back Pressure sensing devices.

7.12. Cost

The cost of the items purchased or on loan from various suppliers amounts to approximately £600; 75% of this figure could be allocated to fluidic devices. Discounting all experimental time, the estimated cost of the manufactured units and assembly is £650, giving a total of £1,250 for a one-off experimental control system. Assuming a reasonable number of linear control systems

could be produced, and were re-designed to suit existing manufacturing techniques, such as etched circuits with integrated logic devices, moulded programme units etc.; the cost would be in the region of £650 each, plus a tooling and sales charge. The inclusion of such extras as a programme read-out, fault finding panel, coolant supply control etc., would increase the cost to about £850 - £950, approximately 50% of the cost of an existing sequence control system.

The running cost of a fluidic system is controlled by the air consumption of the fluidic circuits and power cylinders; the latter being a variable and dependant upon the component. There is no doubt that the running cost is high, when compared with an electronic system. Three cubic feet per minute at fifteen pounds per square inch, and fifteen cubic feet per minute at ten pounds per square inch of air, was required to operate the experimental systems' sensing and logic circuits. These figures are high because of the valve operating pressures, which if reduced would make a considerable saving in air consumption.

References:

1. Parker, G.A.
Pure fluid control and automation. Discover.
Vol. 27. No. 3. March 1966. pp 31-36.
2. Stal, H.P. and Bulk, J.
The application of fluidics in Numerical Control
of machine tools. 2nd Cranfield Fluidics
Conference. B.H.R.A. 1967.
3. Foster, K., Mitchell, D.G. and Retallick, D.A.
Fluidic circuits used in a drilling sequence
control. 2nd Cranfield Fluidics Conference.
B.H.R.A. 1967.
4. Charnley, C.G.
Fluidics in Production Engineering. Proc. I.Prod.E.
Vol. 47 No. 2. February 1968. pp 63 - 82.
5. Foster, K., and Parker, G.A.
The Role of Pure Fluidic Devices in Machine
Tool Applications. Proc. I.Prod.E. Vol. 48 -
No. 4. April 1969. pp 169 - 180
6. Stoneman, H.M.
The Maxalog fluidic control system. Proc. I.Prod.E.
Vol. 48 - No. 5. May 1969. pp 211 - 217.
7. Sykes, N.W.
Industrial fluidic components and their application
to an automatic pin orientation and socket testing
device. Proc. I.Prod.E. Vol. 48 No. 5 May 1969.
pp 218 - 225.
8. Linford, A.
Fluidics - Principles and Practice. Proc.I.Mech.E.
Vol. 16 - No. 5 May 1969 pp. 197 - 202.
9. Corning Fluidic Products
Logic Components Handbook.
10. Electrosil Ltd.
Fluidics Application Data Sheets.
11. The Plessey Co. Ltd.
Fluidics Handbook and Data Sheets.

12. Maxam Power Ltd.

Fluidics handbook and data sheets.

13. First International Conference

Fluid logic and Amplification. September 1965.

B.H.R.A. and Dept. of Prod. and Ind. Admin.,
College of Aeronautics, Cranfield.

14. Second Cranfield Conference. January 1967

B.H.R.A., I.Mech. E, Soc. of Int. Tech. and
Dept. of Prod. and Ind. Admin., College of
Aeronautics, Cranfield.

15. Third Cranfield Conference. May 1968

B.H.R.A. and Inst. de Techologia Mecconia, Milan.

APPENDIX I

A.1.1.

Fluidic Terminology

- Amplifier:-** A device, or system which provides an output that is different in magnitude from the control input. A variety of techniques to perform the amplification function have been developed in the fluidic field.
- Analogue:-** Presentation of a variable by physical quantity in a defined relationship; for example, a dial indication of pressure.
- And Gate:-** A logic element or circuit in which a number of input signals must be present before transmission occurs. In pneumatic logic, a two-input And is used; both must be energised to cause switching.
- Back Pressure:** A secondary output signal; a product of partial or full impedance of circuit flow.
- Bistable:-** Elements which have two output possibilities, and which will hold a given condition until switched, are classified as bistable devices.
- Bias:-** Asymmetry in a device or circuit. This may be accidental as in production tolerancing, or purposeful, as in the case of control port bias used to modify sensitivity or other features.
- Capacitance:** A storage device; in the case of fluid devices, it accumulates fluid by virtue of its volume and pressure head available.
- Circuit:-** An array of elements inter-connected to perform functions beyond the range of single element capability.
- Control:-** A signal received at system input; used as intelligence to produce a modification in output.
- Digital:-** General class of elements or circuits which have "on-off" characteristics.

- Diode:-** Element which has high resistance to flow in one direction, low resistance to flow in the opposite direction.
- Fan-in:-** Number of units which may be input - connected to a single similar unit.
- Fan-out:-** Number of units which may be operated in parallel from a single similar element. "Similar" in this case refers to the operating parameters such as impedance and does not mean identical function devices.
- Flow:-** Quantity passing a point per unit time. In pneumatics, this is commonly represented by C.F.M or Cubic feet per min.
- Fluid:-** Any non-solid media.
- Flip-Flot:-** A bistable sub-system which will alternate from one output to another upon receipt of correctly phased input signals.
- Gain:-** Ratio of output change to control change.
- Gate:-** A device or circuit which allows the passage of a signal only if certain control requirements have been satisfied.
- Hysterisis:-** The disparity between forward and reverse function traces.
- Impedance:-** Total opposition to circuit flow, represented by resistance, capacitance, and inductance combined to a resultant.
- Inductance:-** Inertial resistance to flow change as applied to fluidic circuits. Generally of second or less order effectiveness.
- Monostable:-** A System having an "At rest" bias which causes one output condition consistently, until appropriate input signaling is performed.
- Or-Nor gate:** This class represents a scheme which will provide output switching upon reception in simplest form, of any or all of a number of inputs.
- Power:-** A device which causes a change in output power following a change, of sufficient magnitude, in control power.
- Pressure:-** A device which causes a change in output pressure following a change, of sufficient magnitude, in control pressure.

- Proportional:-** A unit which maintains a regulated relationship from control pressure results in an analogous increase in output pressure for the case of a pressure-amplifying proportioner.
- Recovery:-** In fluidic devices, a generally percentile representation of output capture as related to supply. This might be such as output pressure versus input pressure.
- Resistance:-** Most often the primary contributor to flow opposition. Characteristically, a resistor produces a pressure drop which may be expressed as a function of flow. All devices which do not insert energy into a system produces resistance to flow.
- Response:-** Relationship between output and input after a system disturbance, as directed to phase and or time parameters.
- Sensor:-** Information pick up device.
- Supply:-** Power source.
- Transducer:-** Device which converts signals received in one media into output in some other media; e.g. the dial pressure indicator converts fluid pressure into mechanical displacement.
- Turbulence:-** Digital element using laminar-to-turbulent flow transition to create the control effect.
- Value:-** A device or system which has the capability of flow diversion, cut-off, or modulation.
- Vortex:-** Amplifiers using momentum - interaction to produce stream rotation and consequent output modification.
- Wall Attachment:-** A family of elements which make use of flow created low pressure regions, causing fluid to adhere to an amplifier wall in a control manner.

FLUID LOGIC COMPONENT SYMBOLS.

A. 1. 4.

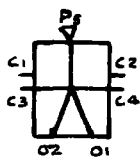

BISTABLE
FLIP-FLOP.

AIR IS SUPPLIED TO P₅ AND A PRESSURE WILL APPEAR AT ONE OF THE OUTPUT PORTS, SAY O₁, BUT NOT O₂. A CONTROL SIGNAL AT C₂, EITHER CONTINUOUS OR PULSE WILL SHIFT THE OUTPUT TO O₂ WHERE IT WILL REMAIN UNTIL A CONTROL SIGNAL AT C₁ SHIFTS THE OUTPUT TO O₁.

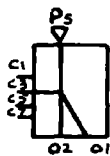

OR/NOR
GATE

AIR IS SUPPLIED TO P₅ AND A PRESSURE WILL APPEAR AT OUTPUT O₂. A CONTINUOUS CONTROL SIGNAL AT C₁, C₃, C₅ OR C₇ MUST BE PRESENT TO GET AN OUTPUT AT O₁, BUT NEITHER C₁, C₃, C₅ OR C₇ CAN BE PRESENT TO GET AN OUTPUT AT O₂.

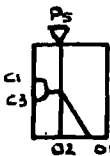

AND
GATE

AIR IS SUPPLIED TO P₅ AND A PRESSURE WILL APPEAR AT OUTPUT O₂. A CONTINUOUS CONTROL SIGNAL AT C₁ AND C₃ MUST BE PRESENT TO GET AN OUTPUT AT O₁. ABSENCE OF EITHER OR BOTH CONTROL SIGNALS WILL RESULT IN AN OUTPUT AT O₂.

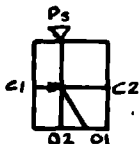

SCHMITT
TRIGGER

THIS IS A SWITCHING DEVICE USED IN CONJUNCTION WITH SENSORS. THE SWITCHING BAND IS THE DIFFERENCE BETWEEN THE CONTROL PRESSURES C₁ AND C₃, THE SWITCHING POINT CAN BE ADJUSTED BY VARYING THE BIAS PRESSURE. WHEN C₁ IS GREATER THAN C₂ OUTPUT SWITCHES FROM O₂ TO O₁ THEN BACK TO O₂ WHEN C₂ IS GREATER THAN C₁.

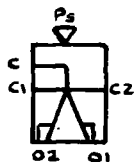

BINARY
COUNTER

THE OUTPUT IS SWITCHED FROM ONE OUTPUT PORT TO THE OTHER WITH EACH SUCCEEDING INPUT SIGNAL OR PULSE AT C. C₁ IS THE SET CONTROL TO GIVE AN INITIAL OUTPUT AT O₁ AND C₂ THE RESET CONTROL TO SET THE COUNTER OUTPUT TO O₂.

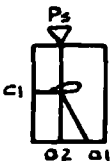

FIXED ONE SHOT
MULTIVIBRATOR

AIR IS SUPPLIED TO P₅ AND A PRESSURE WILL APPEAR AT OUTPUT O₂. A CONTROL SIGNAL AT C₁ WILL SHIFT THE OUTPUT TO O₁, FOR 10 MS. IRRESPECTIVE OF THE DURATION OF CONTROL SIGNAL C₁.

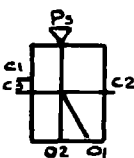

INHIBITED OR
GATE

AIR IS SUPPLIED TO P₅ AND A PRESSURE WILL APPEAR AT OUTPUT O₂. A CONTINUOUS CONTROL SIGNAL EITHER C₁ OR C₃ MUST BE PRESENT TO GET AN OUTPUT AT O₁. NEITHER C₁ NOR C₃ CAN BE PRESENT TO GET OUTPUT O₂. A SIGNAL AT C₂ WILL OVER RIDE C₁ OR C₃ AND THE OUTPUT WILL BE AT O₂.

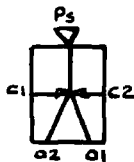

DIGITAL
AMPLIFIER

THIS IS A HIGH POWER OUTPUT FLIP-FLOP, CONTROL SIGNAL C₁ MUST BE MAINTAINED TO GIVE OUTPUT O₁, C₂ TO GIVE OUTPUT O₂. THE OUTPUT IS 300% GREATER THAN A BISTABLE DEVICE AND CAN BE USED TO CONTROL INTER-FACE DEVICES.

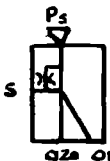

BACK PRESSURE
SWITCH

THIS DEVICE IS USED TO DETECT THE CLOSURE OF A SENSOR AND PROVIDE AN INPUT TO A FLUIDIC CIRCUIT. AIR SUPPLIED TO P₅ WILL GIVE OUTPUT O₂ AND A SIGNAL PRESSURE OUTPUT AT PORT S. CLOSURE OF S WILL SWITCH THE OUTPUT TO O₁.

FLUID LOGIC COMPONENT APPLICATION DATA.

A. I. S.

AVERAGE AIR CONSUMPTION.

- MULTIPLIERS.
 BX1 FLIP-FLOP
 Qx1 OR/NOR
 Qx1 AND
 Qx1 INHIBITED OR
 Qx1-5 BACK PRESSURE
 Qx2 ONE SHOT
 Qx2 DIGITAL AMPLIFIER
 Qx4 SCHMITT TRIGGER
 Qx7. BINARY COUNTER.

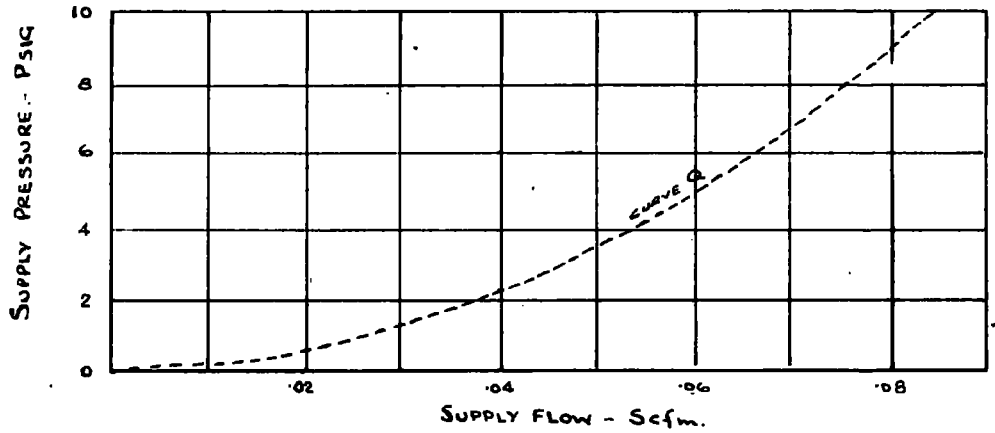

CONTROL AND OUTPUT CHARACTERISTICS.

- VALID FOR
 FLIP FLOP
 OR/NOR
 AND
 INHIBITER OR
 ONE SHOT VIBRATOR
 SCHMITT TRIGGER
 BINARY COUNTER.

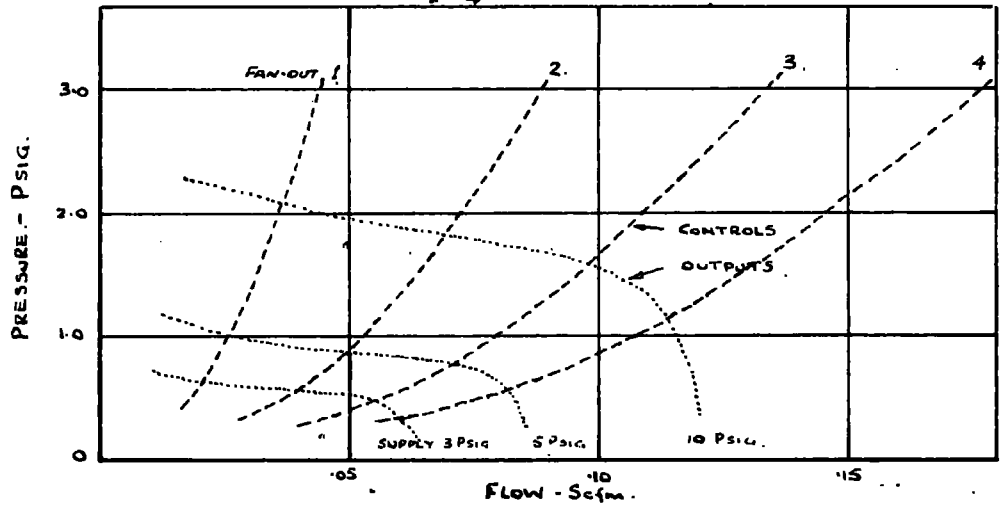

DIGITAL AMPLIFIER
CHARACTERISTICS.

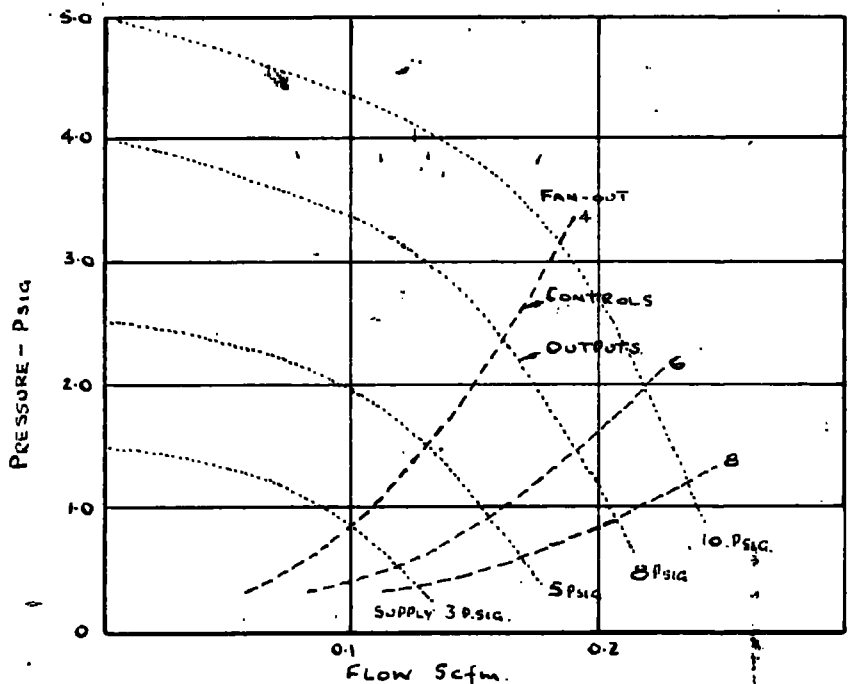

APPENDIX II

A.2.1.

Pneumatic and Hydraulic Equipment

Five Port- Diaphragm Actuated valve:

This diaphragm activated spring reset valve is designed to operate from a signal pressure of two pounds per square inch. A micro valve operated by the diaphragm, allows air pressure on the piston of the main spool moving it through the seals, and allowing air to pass from the inlet port to one side of the cylinder; simultaneously exhausting the opposite side to atmosphere. The body is constructed from duralumin and plastic, with nitrile seals, stainless steel spool and spring. Performance characteristics are shown on A.2.4; the valve being suitable for supply pressures ranging from 35 - 150 p.s.i.g. and diaphragm signal pressures from 2 - 150 p.s.i.g.

Three port- Micro Diaphragm Actuated Valve:

This diaphragm actuated spring reset valve, is designed to operate from a signal pressure of two pounds per square inch, which move a poppet valve to connect the inlet and outlet ports. When the signal is removed, the spring returns the poppet valve to rest position. Components of the valve are manufactured in similar materials to the five port valve; performance characteristics are shown on A.2.4.

Three port- Micro Toggle Valve:

The valve is constructed in a similar manner to the above; in place of the diaphragm, a lever is used to move the poppet valve and hold it in an open position.

Three port- Micro Rush Button Valve:

The valve construction is similar to the above; the lever is replaced by a push button which moved the poppet valve to connect the inlet and outlet ports. When the push button pressure is removed, a spring returns the poppet to the "rest" position.

Flow Control Regulating Valve:

This valve is uni-directional; it restricts the flow in one direction and allows free flow in the other. This characteristic is produced by the adjustable needle restrictor and non-return valve incorporated in the valve body. When fluid is flowing in the "controlled" direction, it must pass through the needle restrictor as the non-return valve is closed. Fluid flow in the opposite direction opens this valve, and the restrictor is by-passed to give a free flow condition.

Circuit and Component Symbols

An abridged list of C.E.T.O.P. circuit symbols, used in the pneumatic-hydraulic circuits are illustrated on A.2.3. These symbols are pictorial representations of the various units; in the case of valves, the first frame is the activated condition, and the second frame illustrates the valve at rest.

Since compiling the list, a revised British Standard has been issued which now replaces C.I.T.O.P. circuit symbols.

C. E. T. O. P. CIRCUIT SYMBOLS.

A. 2 3

	MAIN LINE HYDRAULIC		DOUBLE-ACTING CYLINDER NON CUSHIONED
	MAIN LINE AIR		DOUBLE ACTING CYLINDER CUSHIONED
	PILOT LINE		SINGLE ACTING CYLINDER SPRING RETURN
	DRAIN LINE		
	MAIN PRESSURE INLET		
	EXHAUST WITH THREADED CONNECTION		
	EXHAUST WITHOUT THREADED CONNECTION		
	SILENCER		5 PORT VALVE DOUBLE PRESSURE OPERATED
	AIR RESERVOIR		3 PORT VALVE DOUBLE PRESSURE OPERATED
	FILTER		3 PORT VALVE SOLENOID/SPRING RETURN
	LUBRICATOR		3. PORT VALVE PUSH BUTTON/SPRING RETURN
	STOP VALVE		3 PORT VALVE CAM BALL/SPRING RETURN
	PRESSURE REGULATOR WITH RELIEF.		3 PORT VALVE TOGGLE/SPRING RETURN
	FLOW REGULATOR UNI-DIRECTIONAL		3. PORT VALVE DIAPHRAGM/SPRING RETURN
	NON-RETURN VALVE		3 PORT VALVE TIME DELAY
	QUICK EXHAUST VALVE		5 PORT VALVE SOLENOID OPERATED - AIR PRESSURE ACTUATED /SPRING RETURN.
	SHUTTLE VALVE		
	TORQUE UNIT		

VALVE FLOW CHARTS.

A. 2. 4

FLOW THROUGH MICRO VALVE.

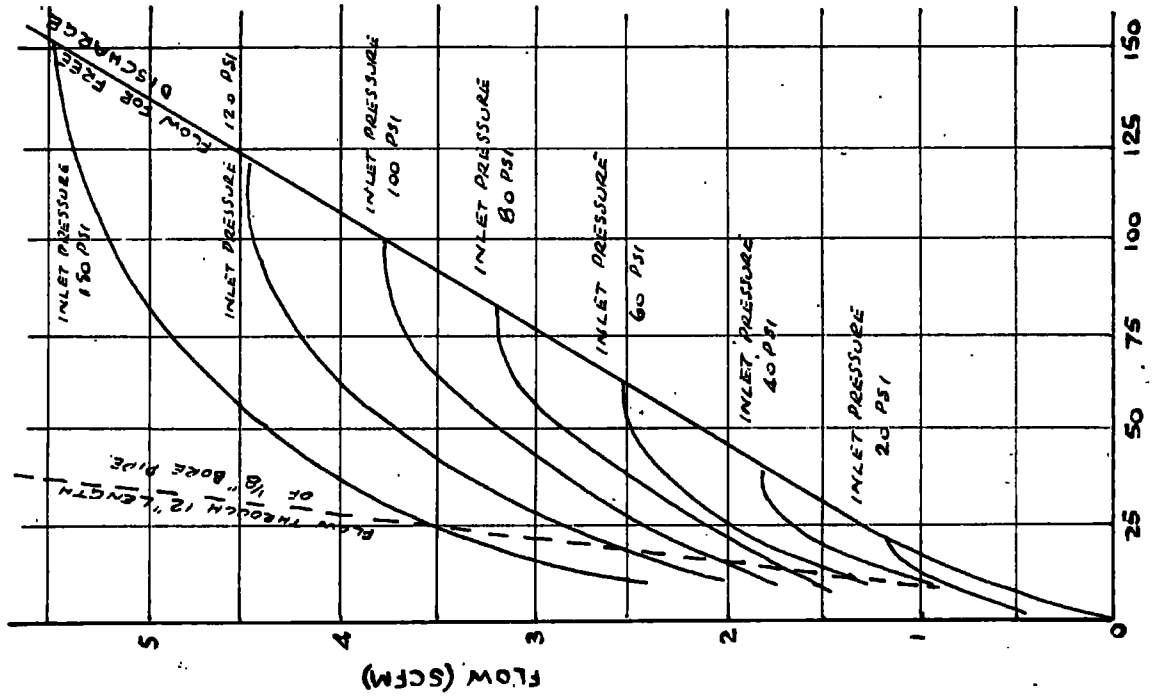

DIFFERENTIAL PRESSURE ACROSS VALVE (P.S.I)

FLOW THROUGH SPOOL VALVE

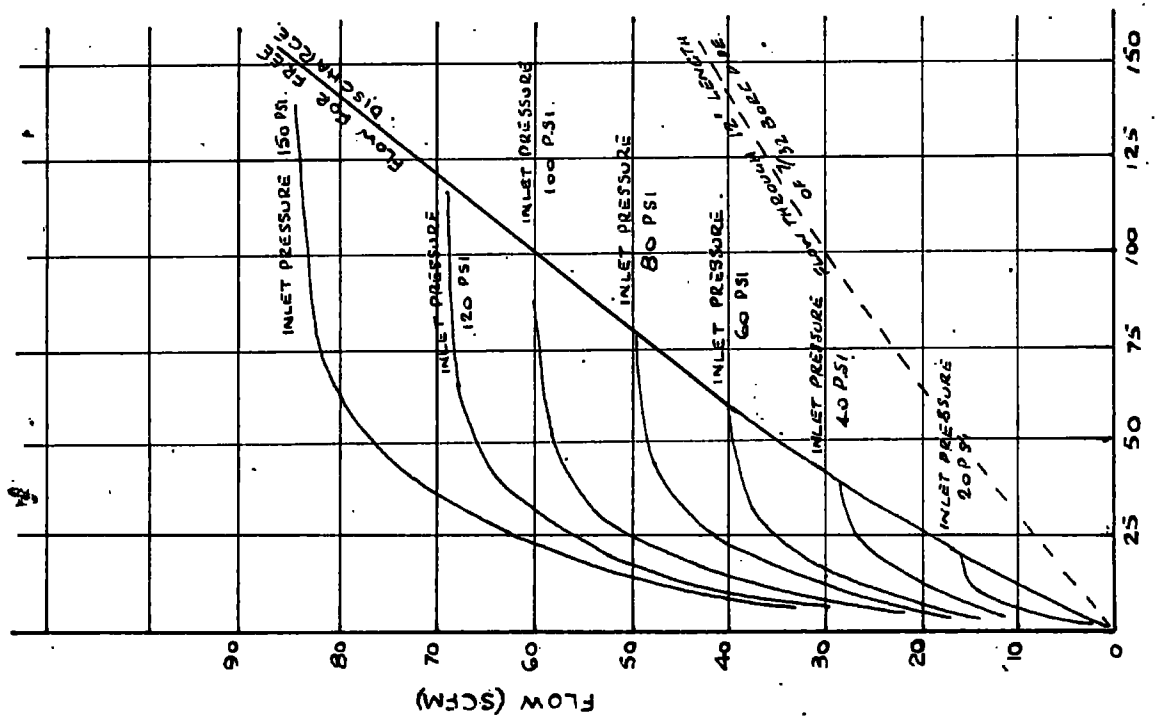

DIFFERENTIAL PRESSURE ACROSS VALVE (P.S.I)