



## Durham E-Theses

---

### *Systems of relationships among the Bedouin of Northern Cyrenaica*

Evans, J. H. P.

#### How to cite:

---

Evans, J. H. P. (1970) *Systems of relationships among the Bedouin of Northern Cyrenaica*, Durham theses, Durham University. Available at Durham E-Theses Online: <http://etheses.dur.ac.uk/10237/>

#### Use policy

---

The full-text may be used and/or reproduced, and given to third parties in any format or medium, without prior permission or charge, for personal research or study, educational, or not-for-profit purposes provided that:

- a full bibliographic reference is made to the original source
- a [link](#) is made to the metadata record in Durham E-Theses
- the full-text is not changed in any way

The full-text must not be sold in any format or medium without the formal permission of the copyright holders.

Please consult the [full Durham E-Theses policy](#) for further details.

Systems of Relationships among the Bedouin of  
Northern Cyrenaica.

---

M.A. Thesis, 1970

---

J.H.P. Evans  
Department of Anthropology,  
University of Durham.

The copyright of this thesis rests with the author.  
No quotation from it should be published without  
his prior written consent and information derived  
from it should be acknowledged.

CONTENTS

Preface	page v
Part One The Sa'adi	
1 Introduction	1
2 History of Occupation	20
3 Physical Background	31
4 Genealogy and Territory	43
5 Political System	61
Part Two	
6 The Marabtin in General	79

## Part Three The Fawakher

## I General

7	Historical Background	page 95
8	The Fawakher and the Government	104
9	Physical Background	109
10	Subsistence Activities	
	a) Pastoralism	117
	b) Cultivation	127
11	Religion	133

## II Organization and Relationships

12	Genealogy and Sections	147
13	Tertiary Section	160
14	The Camp Group	173
	a) A Camp in Detail	176
	b) Male/Female Relationships	188
	c) Family and Kinship Relations	196

## III

15	Conclusion	216
----	------------	-----

Bibliography	221
--------------	-----

Maps

I-----Area under discussion in the thesis	page 2
II-----Tribal map of Cyrenaica	2a
III---Rainfall and the plateau area	4
IV----Climatic zones	4
V-----Distribution of forest	7
VI----Pastoral zones	7
VII---Fawakher tribal territory	99
VIII--The camp of Muhammed al-'Abd	177

Diagrams

1.----Numbers of livestock	8
2.----Sales of livestock and agricultural commodities	8
3.----Sa'adi genealogy	13
4.----Tribal divisions	45
5.----Territorial divisions of a tribe	47
6.----Structural and territorial interrelationships	47
7.----The balanced opposition of sections	65
8.----Fawakher genealogy	148
9.----Agnatic core group of the camp of Muhammed al-'Abd	180
10.---Spatial and structural distance in the camp of sheikh Muhammed al-'Abd	181

## Preface

The material for this thesis was collected over a period of four months, from March 16th. to July 17th. 1967, and stems from three sources. Two and a half months spent with the Fawakher, two weeks with the 'Abid and a month talking to Libyans in Benghazi many of whom lived during their childhood in tented communities and were members of the Bara'asa and 'Abaidat tribes.

Only three months were actually spent in the field because of the necessity first of all of receiving permission from various ministries for the study and secondly for a longer visa to cover what was hoped, at the time, would be a stay of one year. Thirdly the outbreak of the Arab-Israeli war and the implied British involvement necessitated a stay in the D'Aosta army barracks in Benghazi. The field work itself had to be terminated because of the considerable tension which existed after the war, my inability because of this tension to receive information and help from the tribe with whom I was staying, and finally the considered opinion that the war would break out again thus making further field work impossible.

Inevitably, therefore, the material which I will present in this thesis has suffered through the short period of field work and my insufficient knowledge of Arabic. Many problems which I would like to have discussed have had to be eliminated through lack of information, and those with which I have concerned myself could have been improved through a longer stay among the tribes. As a result I have had to make extensive use of the alternative sources of information, Evans-Pritchard's book on the Sanusi and the thesis and articles of Peters. I hope, however, that the material which I was able to collect and which is presented below will provide a new source of information and will be some contribution to an understanding of the Cyrenaican tribes.

In transliterating arabic words I have not used any of the accepted systems but have given what I consider to be an approximation of arabic sounds. The arabist will, I think, recognise what I have written without too much difficulty and the non-arabist would not have received a deeper insight into the material had I used a special method of transliteration.

My field work among the Fawakher was made fruitful by their hospitality, unflinching help and friendship. I would like therefore to thank especially Sheikh Muhammed al-'Abd, Bashir Muhammed al-'Abd, 'Ataraif and Salim. I would also like to take this opportunity of thanking all those people who helped me whilst in Benghazi and in fact made this study possible through their generosity and aid, especially Salim 'Ali Hajjaji, 'Abdul 'Ati al-'Abaidi, Shaiyib Yunis al-Mansouri, 'Assad Massoudy, 'Abdul Hamid Tayyar, Mr. and Mrs. C. Thomas, Pablo Foster, David Barber and Anthony Thwaite.

Finally my greatest thanks are due to my supervisor Dr. Eric Sunderland for his unflinching interest and help.

Jeffrey H.P. Evans



## Part One            THE SA'ADI

1 Introduction

The area under consideration in this thesis forms part of Cyrenaica, one of the three provinces of the former Kingdom of Libya, now the Arab Republic of Libya.. The part with which I am concerned, see map I. p.2., is the most northerly section of that province, having as its southern boundary the group of oases at Jalo, as its northern the Mediterranean, as its western Tripolitania, and as its eastern the Egyptian border. This is an area of approximately 100,000 square miles with a population of about 291,000 of whom 130,950, or 45%, are Bedouin.

Although the area is large its physiography is relatively simple, with a plateau region, the Jabal Akhdar rising steeply in the north from the narrow coastal plain and descending very gently southwards to the Sahara. On the west the narrow coastal plain gradually broadens south-westwards into the Barqa plains, and on the east the plateau descends as a series of ridges, only a few hundred feet high to the Egyptian border.

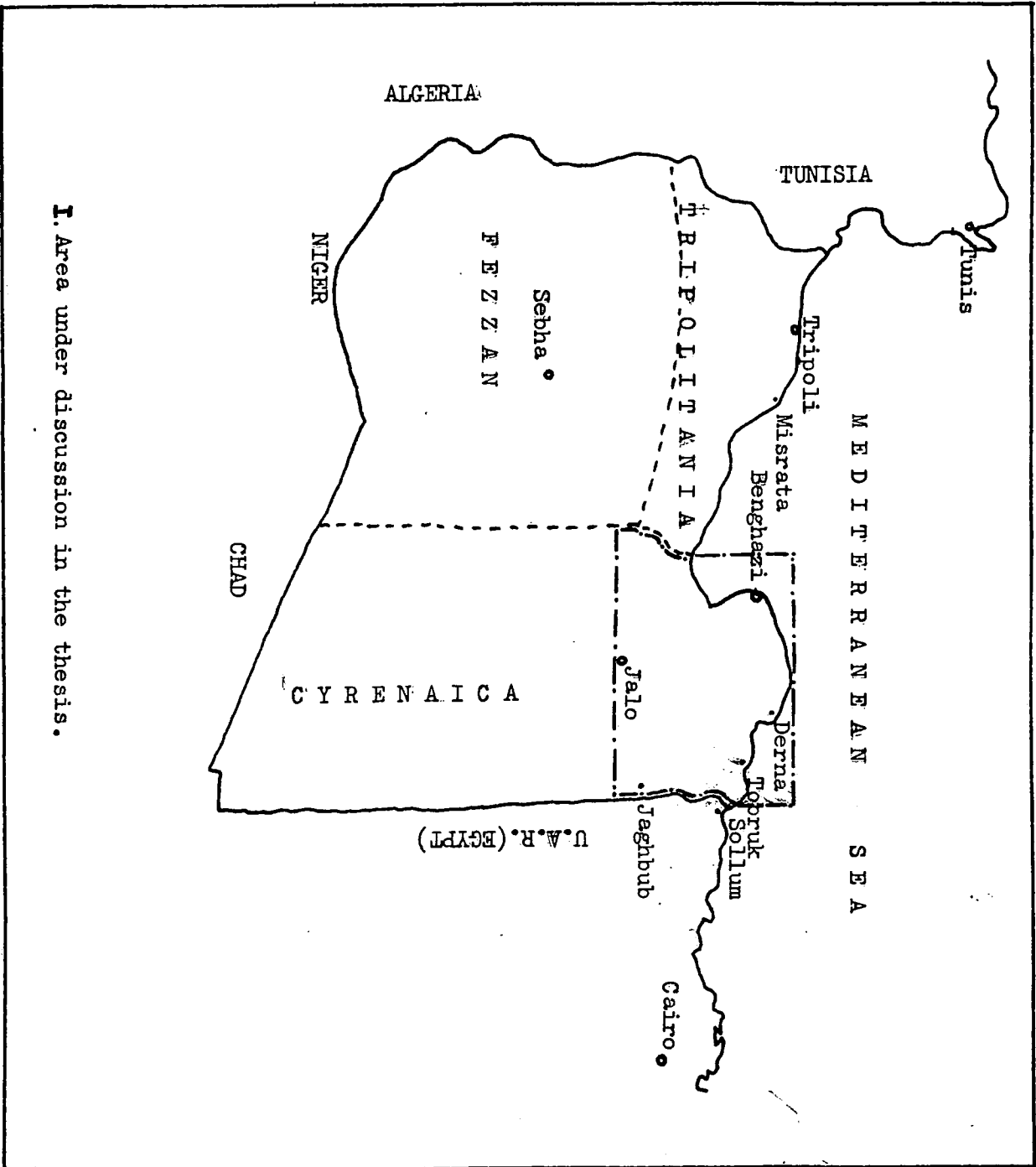

I. Area under discussion in the thesis.

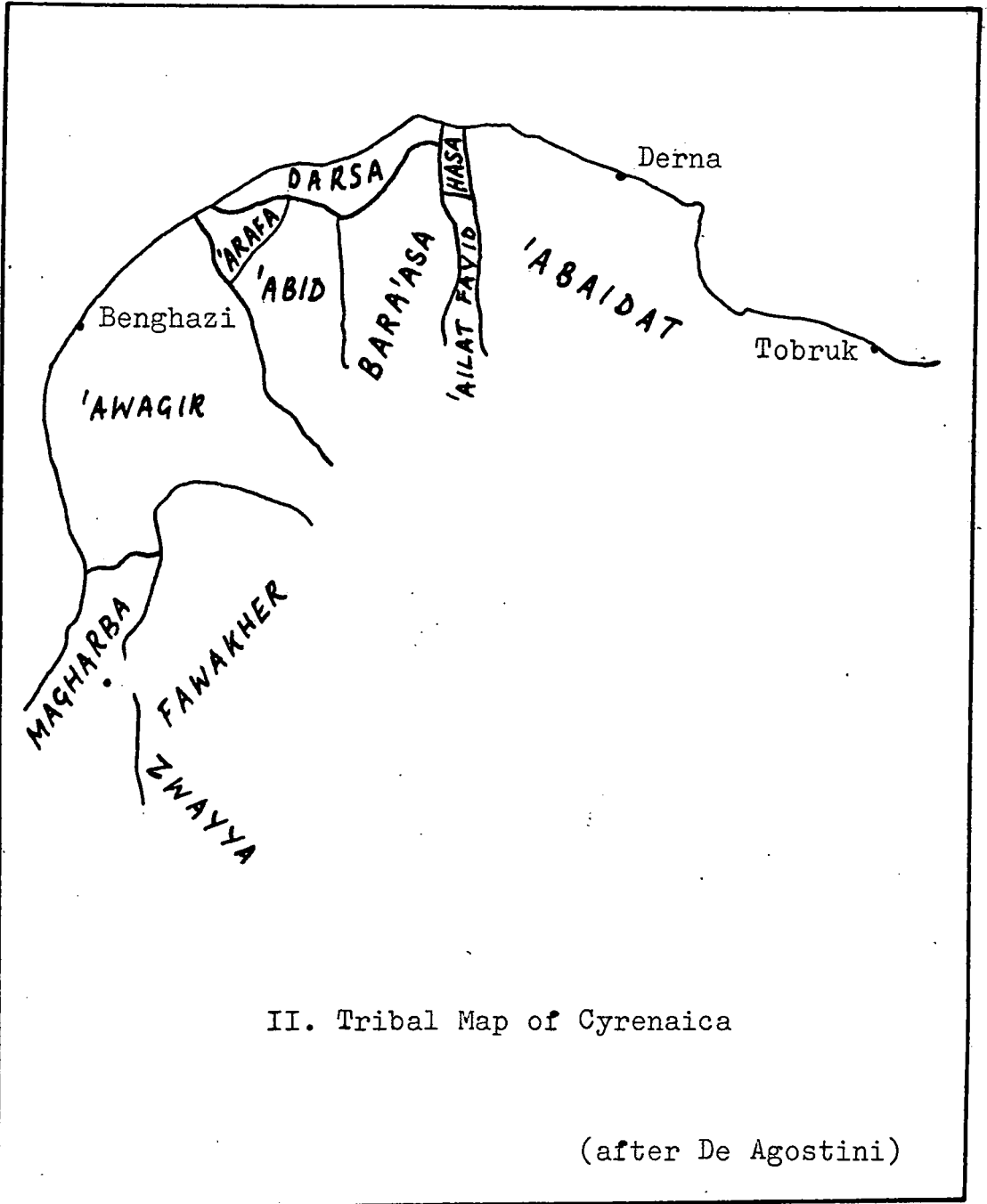

II. Tribal Map of Cyrenaica

(after De Agostini)

The proximity of the Jabal Akhdar to the coast, and its steep northern slope have meant that east-west movement has been restricted to the coastal plain and to the open steppe of the south. The coastal plain has been the route of conquest, at least since Islam, whereas the steppe provides a wide, open, pasture belt for the Bedouin to drive flocks and herds to the markets in Egypt. As can be appreciated north-south movement, from the coastal plain, was limited, at least before the construction of modern roads, by the difficulties of ascending the Jabal scarp. Movement however from the plateau top southwards into the steppe has always been possible, and easy, and this is one factor, among others, for the predominance of trans-humance among the tribes of the north.

One of the other factors, apart from the ease of movement, which has contributed towards the presence of Bedouin in this area has been the distribution of rainfall, see map III.p.4. Northern Cyrenaica lies in the path of westerlies and has as a result greater precipitation than the rest of Libya. The most favoured part of the province is the Jabal Akhdar which receives 15-20 inches (400-500 mms) annually, falling mainly between October and April. Generally speaking the

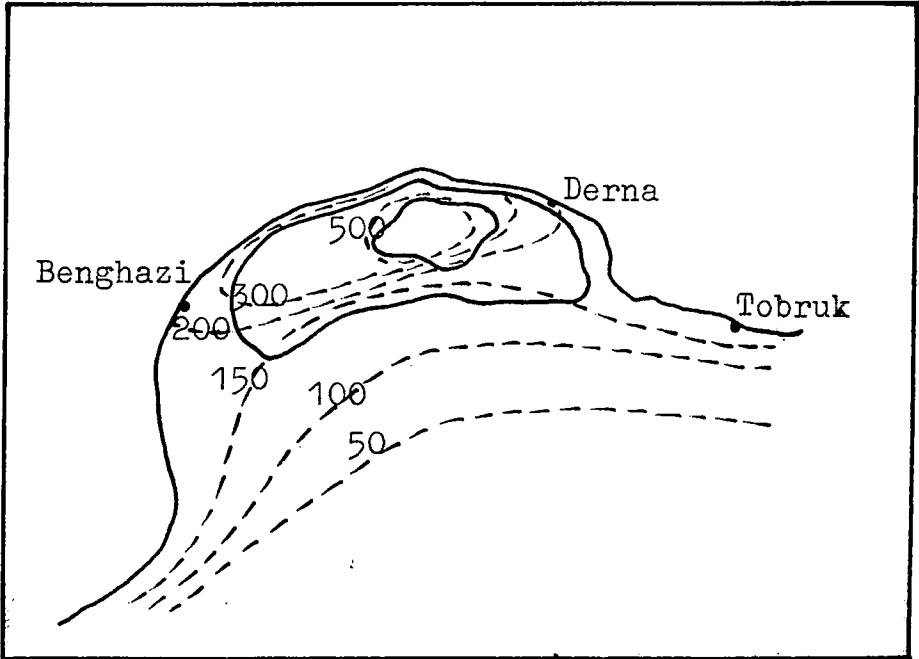

--- Isohyets showing mean annual aggregates in mms.

III. Rainfall and the Plateau Area

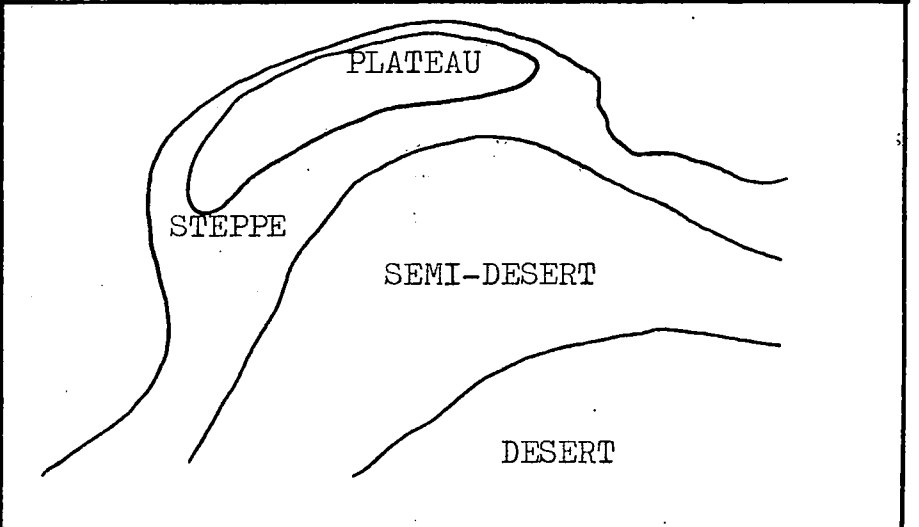

IV. Climatic Zones

after E.E.Evans-Pritchard

amount of rainfall decreases from west to east and also from north to south, the south, for example, receiving less than 2 inches annually..

The variability of the rainfall is reflected in the distribution of the vegetation.. The vegetation is most luxuriant on the Jabal, where it manifests itself as 'forest' but gradually decreases in size and luxuriance towards the south, appearing on the steppe as grasses, low bushes and scrub,, and on the fringe of the Sahara as drought resistant plants..

The three factors of physiography, rainfall and vegetation combine to determine the type of economic existence which is most suitable for this area. Although on the plateau agriculture has always been important, in the area as a whole pastoralism has predominated at least since the first Arab invasion of the 7th. century.. The Hilalian invasions of the 11th. century finally established pastoralism as the dominant economic activity for the next eight hundred years. Today the greatest emphasis is placed, by the government, on settled agriculture and the production of grains and tree crops.. The proportion of the total area devoted to these activities is however minute in comparison with that

which supports the Bedouin and their herds.

The gradation of vegetation from forest to xerophytic and the distribution of the rainfall enables different types of livestock to exploit the environment. The differences in the animals and the territories which they utilize creates in turn varying degrees of mobility among the Bedouin from tented but stable to true nomadic. In general terms cattle and goats predominate on the plateau, see map VI.p.7. Cattle can be pastured there because of the lower temperatures,, the availability of water and the relatively lush grasses. Goats, however form the majority of the livestock and are the real exploiters of the environment feeding from the bushes and trees.. On the steppe cattle and goats are replaced by sheep and camels, and the further south one goes the greater the proportion of camels to sheep in the herds until the area is reached which can only be utilized by the camel..<sup>+</sup>

The distribution and erratic nature of the rainfall has meant that the Bedouin have remained pastoralists.. The uncertainty attendant upon agriculture

---

<sup>+</sup> See diag.1 p.8. for numbers of livestock.

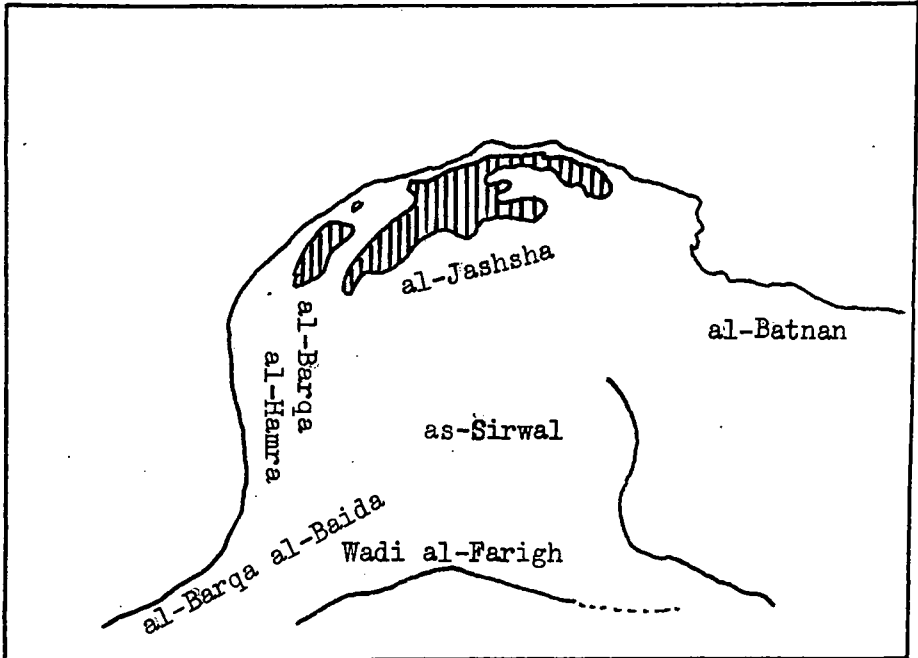

Forest

V. Distribution of Forest.

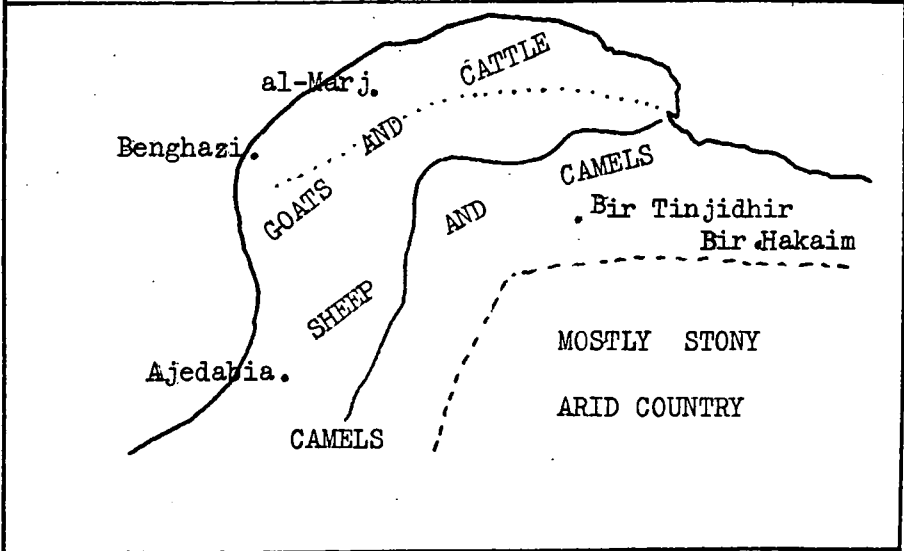

..... Approximate. Line of Springs  
 .. Southern limit of well water in summer  
 - - - Southern limit of grazing in spring

VI. Pastoral Zones.

after E.Evans & Pritchard.



Numbers of Livestock in Cyrenaica  
(in thousands)

	<u>1956</u>	<u>1958</u>
Sheep.....	815.....	785
Goats.....	586.....	661
Cattle.....	60.....	59
Camels.....	76.....	83

diagram 1.

Annual Sales of Livestock and Agricultural Commodities  
in Cyrenaica

1957-1958 in  $\text{L}$  millions. .

Cereals (excluding fodder)	0.9
Olives, fruits and nuts	0.4
Other agricultural products	0.4
Animal products	1.2
Exports of live animals	<u>0.8</u>
Total	3.7

(from 'Economic Development in Libya' Johns Hopkins 1960  
diagram 2.

has always been too great and the fluctuation in returns too large, for them ever to have settled or placed total reliance upon cultivation. The presence of sufficient rainfall for crops in good years has, however, meant that they have a mixed economy but with the emphasis on pastoralism.<sup>+</sup> They cultivate barley and wheat in depressions or wadi bottoms throughout northern Cyrenaica. On the plateau the returns are regular but not particularly large, whereas on the steppe they are erratic, but a good year can bring a one hundred fold return. The grain is stored in large piles covered with chaff and clay, in caves, or in fired containers in the ground. Not all Bedouin can or do cultivate but it would be wrong to see cultivation as the first move in the direction of sedentarization. It is in fact an adaptation to the environment which will ensure the Bedouin's continued existence as a pastoralist.

The two economies can be linked together in a most satisfactory way. Ploughing begins with the rains in the middle of October and continues until the middle of November or later, when the movement southwards, in

---

<sup>+</sup> See diag. 2 p. 8. for the proportion of sales of livestock to agricultural commodities.

the case of the plateau Bedouin, begins. This movement is necessary because the ewes, having been served in June, start dropping their young in November and December. The new grasses have appeared on the steppe and the flocks and herds are moved southwards to take advantage of them. The warmth of the south also helps the lambs and kids. The pasture remains good until April or May, when the temperature begins to rise and the grasses begin to turn yellow. The flocks and herds return northwards to the plateau, where the grass is still green and where water is more abundant. Movement coincides with harvesting which usually takes place in mid-April and lasts until June or July. During this time milk gets scarcer and lactation finally finishes in June or July. This is however not a period of hardship for the Bedouin because they have been using and continue to use barley or wheat from other years. In October ploughing starts again.

Although the account so far has been more applicable to the Jabal tribes it is generally true of the others also because all tribes move to take advantage of the pasture created by the winter rains. It is during the months January to May that a tribe is most scattered, consisting of a large number of small camps. As the

temperature increases, the grass dries up, and the flocks and herds require watering more often. It is at this moment that movement back to the plateau begins, as mentioned above, or for the other tribes movement to permanent sources of water around which they concentrate. It is usually here, at, or near these water sources that the sowing has been done and the return to these wells and cisterns coincides with harvesting. There are, of course, intermediary situations, in winter, for example, when certain members of a tribe remain behind to complete ploughing and sowing whilst the others move with the stock. In summer some families remain on the steppe with their animals whilst the others return to the more abundant pastures and water of the north.

So far we have been talking about the physiography,, climate and vegetation of Cyrenaica, their effects upon the Bedouin, and how his livelihood is organized to cope with the situation. We need now really to discuss who these Bedouin are, and how they came to be there.

The Bedouin are descendants of invaders who arrived in Cyrenaica in the 7th. and 11th. centuries. The importance of the first invasion lay in its introduction and dispersal of Islam throughout most of the

inhabited areas.. The importance of the second lay in the thoroughness and completeness with which it destroyed the indigenous way of life and any pretensions which the Berber, the former occupants, may have had to owning and occupying Cyrenaica.. The second invasion was also responsible for the partitioning of land among the various tribes all of whom were descendants of the Bani Sulaim, one of the two great invading tribes.. From the 12th. century onwards there was intertribal war on a relatively sporadic but nevertheless intense basis, the last of which being fought in 1832. This left the present nine tribes, the Sa'adi, occupying the land as they do now, with related tribes, such as the Fawayid, Jawazi and Aulad 'Ali, having been thrust out into Egypt and Tripolitania. The nine, therefore, are looked upon as holding the land by right of conquest in contrast to the other Bedouin, the Marabtin, or 'clients', who use the land by grace of these tribes.

The unity of the nine tribes is expressed through their common descent from Sa'ada, the founding ancestress, see diag.3 p.13. They can be split into two 'confederations' the Jibarna, which includes the 'Abid, 'Arafa, 'Awagir, and Magharba, and the Harabi, which

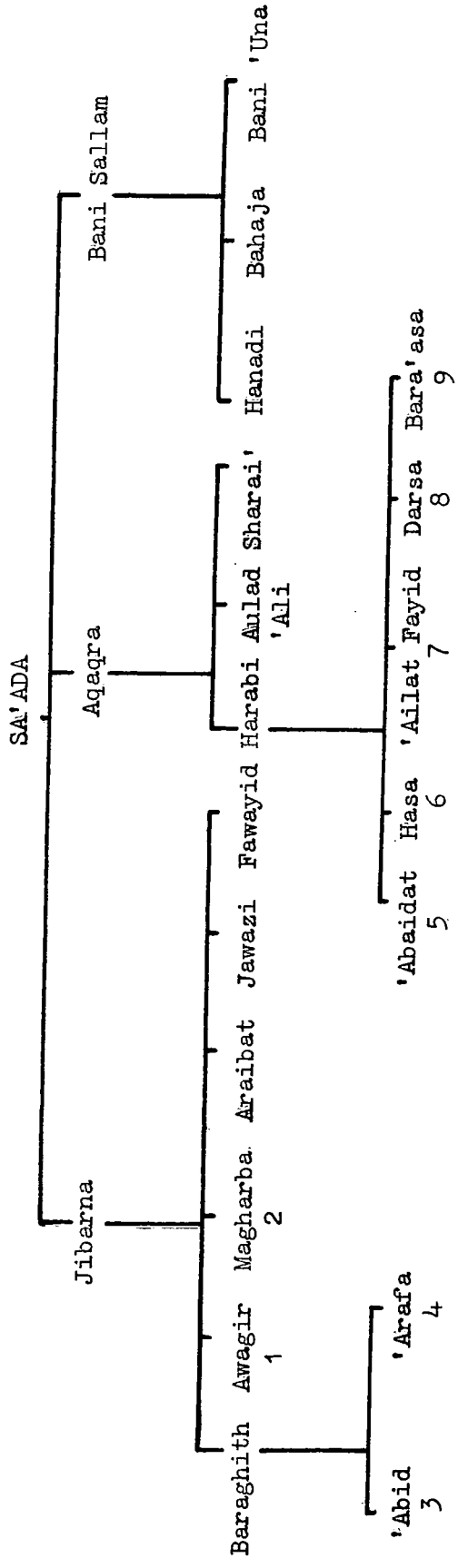

1,2, etc, = The nine Sa'adi tribes of Cyrenaica.

after E.E. Evans-Pritchard.

3. SA'ADI GENEALOGY

includes the 'Abaidat, Hasa, Darsa, 'Ailat Fayid, and Bara'asa.

Each tribe occupies a definite territory in which all its members have rights to land, and water, i.e. pasture, ploughland and wells. The members defend their territory collectively and the tribe thus may be seen as the largest political unit. The tribe can be seen, genealogically, as a clan with a founding ancestor, from whom the tribe takes its name, at the top. Descending from him are a series of lineages each with its named ancestor. As one goes down the genealogy, the numbers of lineages increase and of members decrease until one reaches the minimal level of segmentation which Evans-Pritchard has called the 'tertiary section.' It is here that rights to pasture and wells are really held and that relationships are most intense. The members of the tertiary section are the 'owners in use'<sup>1</sup>, the tribe being seen as the residual owner. The members live in and exploit the same territory, they exact vengeance and receive blood money, and are united against outside

---

1. Evans-Pritchard..E.E. The Sanusi of Cyrenaica. p.55  
Oxford. 1949

encroachment.. The significance of the genealogy and its lineages is considerable because it is on this basis that the land is divided, i.e. lineage expresses territoriality, and through the control of resources by the members political power can be exercised..

The other Bedouin,, the Marabtin,, are as I have mentioned above, in a dependent relationship to the Sa'adi because they rely,, or relied upon them for the right to use pasture and water.. This dependence has decreased to a level where it no longer really exists, but basically their status is different, at least viewed from the eyes of a Sa'adi.. It is, however, difficult to generalise about them because they are seen as belonging to two different groups, although all are Marabtin. This difference can be explained, to a certain extent, by their origin. Some people believe that the Marabtin are the descendants of the indigenous Berber population, others that their ancestors came from the west as pious men or saints, making a pilgrimage to Mecca and Madina. Whatever their origin, they and their descendants settled in Cyrenaica..

The Marabtin as-Sadqan,, Marabtin of the 'fee', who constitute one category pay or are supposed to have



paid for pasture and water for their flocks and herds<sup>+</sup>. They are usually attached to sections of 'noble' tribes and are considered as having an inferior social position. Although spoken of as 'tribes' they are only such in an ethnic sense and not in a political one. This can most readily be realised when it is seen that most of those Marabtin who regard themselves as members of one tribe on the basis of their 'tribal' name are split up into a number of groups aggregated to sections of different Sa'adi tribes. They cannot unite, or at least do not do so, and are therefore powerless to act in opposition to the dictates of the noble tribesmen. There are, however, Marabtin groups who form a majority in the Sa'adi sections and whose power and wealth are very definite attributes to these sections, in this situation there is interdependence.

The Marabtin bil-Baraka, with grace or blessing from God, and the Marabtin 'Ashraf, noble Marabtin who claim descent from the Prophet, constitute the other category of Marabtin. They are mainly divided into small groups and families either living in or between the

---

+ It is doubted whether they ever in fact paid.

territories of noble tribes. Unlike the Marabtin as-Sadqan they do not pay or were not expected to pay a fee for their use of resources. However they do render services to the Sa'adi such as intervention in disputes and helping to cure the sick. Although, in reality, the distinction between paying fees for access to resources and rendering services for their use may seem a minor one the status of the two Marabtin groups vis-à-vis the Sa'adi is very different. The 'baraka' which the Marabtin bil-Baraka are considered to possess, either through their learning or nobility of descent, gives them sufficient prestige so that they are regarded generally as equals of the Sa'adi.<sup>1</sup> The Fawakher, who are also Marabtin bil-Baraka, cannot be covered by the generalisations so far advanced because they form an independent tribe similar in some respects to the Sa'adi.

As I have mentioned in the preface my field work was done among the Fawakher. Although circumstances did not allow for a longer stay among them I came to the

---

1. 'These 'sacred' tribes,....., live among the Sa'adi as equals in virtue of the prestige they derive from their descent, or supposed descent, from saints, though the free tribes do not regard them as quite like themselves..' Evans-Pritchard.E.ϯ. The Sanusi of Cyrenaica. p. 52 Oxford 1949

conclusion and hope to prove that they do not fall into those categories of relationships so far used, i.e. either for the Marabtin as-Sadqan and Marabtin bil-Baraka, or the Sa'adi. This was confirmed for me by the Fawakher's ownership of their land and water, their territorial unity and exclusiveness, their genealogy and their religious belief. Before, however, I can test these hypotheses it is necessary for the purposes of this thesis to give some analysis of the Sa'adi and the Marabtin in general in order that an understanding of the Cyrenaican tribal society as a whole may be achieved and that the Fawakher may be fitted into the total society of which they constitute a part.

The Sa'adi have been studied by Evans-Pritchard and Emrys Peters. The latter's thesis and articles provide the greatest amount of information about the nine noble tribes of Cyrenaica. The information which I can add to this material is small and is largely concerned with elements of Sa'adi society which have already been covered by the work of the anthropologist mentioned above. The choice of topics for discussion was largely dictated by the amount of available material and my own ability to insert new information, or to provide critical comment.

Also, however,, I have concerned myself with those topics which could either illuminate subjects in my own analysis of the Fawakher which I was unable to support because of lack of field work,, or could provide contrasts in attitudes relationships and organisation to those of the Fawakher.. This may seem a somewhat artificial approach but given the difficulties which I came across this seemed to be the best method of approaching the problem.

## 2 History of Occupation

The origins of the Bani Sulaim, the ancestors of the Sa'adi, are reasonably well documented elsewhere<sup>1</sup>. I would, nevertheless, like to give a short history of their background and of their occupation of Cyrenaica because it is through the latter that the Sa'adi lay claims to their ownership of the land and its resources. Also I wish to show briefly how the Sa'adi were affected by the various central governments which held sway over the area but particularly how the Italian occupation affected the organisation of the Sa'adi and altered the relationships of the Sa'adi with the Marabtin.

The history of the Arab occupation of Cyrenaica began in A.D. 643, in the Caliphate of Omar, when 'Amr ibn al-'As, the conqueror of Egypt and Syria, invaded and overran Libya as far as Tripoli and the Fezzan. He met with little resistance and within seventy years the whole of northern Africa was in the hands of the Muslims. However it would seem that the main effects of the invasion were only felt along the coastal strip and in the towns where the majority of the Berbers

---

1. See: Sulaim.Bani. Encyclopaedia of Islam S-Z. Luzac & Co. London. and André J. Histoire de l'Afrique du Nord. Payot Paris 1961 etc.

rapidly embraced Islam, but mainly in its schismatic forms as Kharijites, Ibadites and Shi'a<sup>1</sup>. The invaders neither controlled nor had much effect on the Berbers inland. However all this was to change when in 1047 the Zirid Amir<sup>+</sup>, al-Mu'izz bin Badis, returned to orthodox sunnism, and recognised the Abbasid Caliph of Baghdad.

Al-Mu'izz had formerly acknowledged the suzerainty of the Fatimid Caliph of Egypt, al-Mustansir, and this change of allegiance not only brought the ancestors of the Sa'adi to Cyrenaica but destroyed Zirid power and altered the whole ethnic structure of North Africa. The perpetrators of this upheaval were the two powerful and warlike Bedouin tribes, the Bani Hilal and Bani Sulaim, then resident in Upper Egypt.

The Bani Hilal and Bani Sulaim originally came from Arabia, where they were neighbours, but they were forced to migrate to the Nile Delta<sup>2</sup> after they

---

1. André J. Histoire de l'Afrique du Nord. Payot Paris 1961.

+ A prince of the Berber Zirid dynasty founded in the 10th. century. Its capital, Kairouan, fell in the Bani Hilal invasion. The dynasty was finally destroyed in the 12th. century.

2. Makrizi: Abhandlung über die in Ägypten eingewanderten arabischen Stämme. Wüstenfeld (ed.) in Göttinger Studien. 1947 pps. 421,424,461,464.

had sacked Madina in 844/845. In the 10th. century they supported the Carmethians against the Fatimid al-Aziz bin al-Mu'izz. They were defeated and were moved to Upper Egypt where it was thought they could cause less trouble.

When the Zirid Amir, al-Mu'izz, broke with his suzerain, al-Mustansir, and recognised the Caliph of Baghdad, al-Yazuri, al-Mustansir's vizier advised him to take revenge on the Sanhadja, the tribe on which the Zirid dynasty was founded, by handing over 'Ifrikiya' to the Bani Hilal and Bani Sulaim. In this way al-Mustansir relieved himself of a fractious element and hoped to chastise both al-Mu'izz and the Berbers who had reasserted their independence<sup>1</sup>.

The Bani Hilal set out in 1051 and at first ravaged the province of Barka, which they left to the Bani Sulaim<sup>2</sup>, who had followed them, and they did not approach 'Ifrikiya' proper until the 13th. century. Ibn Khaldun, in the Muqadima<sup>3</sup>, has compared these nomads to a cloud of locusts which destroyed everything on which

---

1. See Hilal.Bani. Encyclopaedia of Islam E-K.1922. London Luzac & Co.

2. See Sulaim.Bani. Encyclopaedia of Islam S-Z.1934. London Luzac & Co.

3. See Khaldun.I. The Muqadimah. An introduction to history. translated by Franz Rosenthal. vol. I pp. 247-308. Bollingen Series.

it descended. The country side was devastated and agriculture was abandoned due to the destruction of irrigation systems and the flight of sedentary farmers.

The Bani Sulaim established themselves in Cyrenaica where their descendants are today and the Bani Hilal moved on to Tripolitania, Tunisia and Algeria, where sections of the tribe continued to fight but under the auspices of the different dynasties which came to power in the region. Whereas the Arabs of the Conquest had been absorbed in the Berber population, especially in the towns, those of the 11th. century promoted the extension of nomadism and were absorbed so little that almost all the arab-speaking Bedouin of the present day Maghreb are their descendants.

According to Toni<sup>1</sup>. the Bani Sulaim were divided into five sections, the Bani 'Oof, Bani Debbub, Bani Zgheb, Bani Haib and Bani Lubaid, who were involved for the next two centuries in more or less continual inter-tribal warfare eventually leaving only the Bani Haib and Bani Lubaid. The present day descendants of these groups are the Sa'adi.

---

1. Toni.Y.T.: The Social Geography of Cyrenaica. Ph.D. thesis. Newcastle-upon-Tyne. Sept. 1956.



This did not mean however that the tribal groupings and boundaries remained established from the 12th. and 13th. centuries onwards. Inter-and intra-tribal warfare, according to Bedouin tradition, recurred probably as a result of increasing population density and the subsequent demand for more land and water. This warfare was responsible for the disappearance from Cyrenaica of many of the tribes shown on the Sa'adi genealogy who either fled before overwhelming force or were driven out. Examples of the latter are the 'Aulad'Ali thrust out by the Harabi confederation into Egypt, and the Fawayid, expelled by the combined forces of the 'Awagir, Magharba and Bara'asa<sup>1</sup>.

At the downfall of the Mamluk dynasty in Egypt, in 1517, Cyrenaica became part of the Turkish domain and remained so until 1912, apart from the period of Karamanlis rule. The history of Cyrenaica remains a blank throughout this period of Turkish dominance but it is certain, that the administration sat lightly on the shoulders of the Bedouin who continued with

---

1. See Evans-Pritchard. E.E. The Sanusi of Cyrenaica. pp. 49 & 50. Oxford 1949.

their established way of life and settled their own affairs.

The period of Italian interest and occupation, 1912-1942, did not leave the Bedouin unaffected. It was a time of considerable disruption caused by twenty years of warfare, between the Italians and the Bedouin.

The effects which the two Italo-Sanusi wars and the colonisation programme had on the Sa'adi were considerable. Firstly tribal land on the Jabal Akhdar was appropriated as part of the Ente corporation's scheme <sup>+</sup> for the settlement of colonists. Initial colonisation was confined to areas close to Italian controlled centres but later these were expanded to include all the most fertile land between Benghazi and Derna.<sup>1</sup> Thus the tribal territories of the 'Awagir, 'Arafa, 'Abid, Darsa, Bara'asa, Hasa and 'Abaidat were affected, to a greater or lesser extent, by the compulsory purchase or forcible appropriation of lands which were vital for cultivation and summer pasture. This caused considerable hardship<sup>d</sup> for the Bedouin and the loss of

---

+ Ente per la Colonizzazione della Cirenaica.

1. Evans-Pritchard.E.E. The Sanusi of Cyrenaica.p.223. Oxford 1949.

large numbers of animals. Some of this land was also given to sedentary Libyan farmers and the consequences of this action still existed 17 years after the war. The 1959 Cambridge Expedition to Libya<sup>1</sup> found that these Libyans still had control of this land despite attempts by the tribesmen to have the land returned or to receive payment for it.

Secondly the large scale loss of animals caused by the lack of pasture and the destruction of herds considered to belong to the resistance fighters, forced many Bedouin to migrate to Egypt where they were able to take refuge among the 'Aulad 'Ali. Because the majority of fighting took place on the Jabal Akhdar, which was most suited to <sup>the</sup> guerilla activities of the Sa'adi, the plateau tribes suffered the greatest losses. Consequently social upheaval was most marked in this area.

Thirdly the indigenous way of life on the plateau was more or less destroyed by losses in manpower. Although the Bedouin as a whole did not rebel each tribe contributed a certain number of men who formed guerilla bands dependent for supplies and refuge

---

1. Report of the Cambridge Expedition to Cyrenaica. 1959.

on the 'pacified' tribes. As their losses were very high each tribe was seriously weakened by the demands of recruitment and herding and cultivation suffered from the lack of manpower. The situation was made worse when Graziani, the vice-governor of Cyrenaica incarcerated whole tribes in concentration camps. It is estimated by Evans-Pritchard that between half and two-thirds of the Bedouin lost their lives between 1911, when the first hostilities occurred, and 1932, when the fighting stopped on the death of the resistance leader Omar Mukhtar.<sup>1</sup>

The Italian occupation and the two Italo-Sanusi wars affected not only the lives and the pastoral and agricultural activities of the Sa'adi but altered the structure and organisation of their society. Much of the land which had been taken from them was not returned after the allied defeat of the Italians and as a result those sections, which had originally used it by right of descent and conquest, lost the power and the status which in Cyrenaica are concomitant with ownership of land and resources. Also the Italian prac-

---

1. Evans-Pritchard.E.E. The Sanusi of Cyrenaica.pp.190 & 191. Oxford 1949.

tice of allowing all groups access to wells and cisterns which they themselves did not need took control out of the hands of the Sa'adi and gave a greater degree of independence to the Marabtin. <sup>1</sup>. Thus the Marabtin did not need to ask for the right to water their flocks and herds from the Sa'adi and the political power which the Sa'adi had once exercised over the Marabtin through their control of resources was diminished and did not return to the same extent even after the Italians had been defeated.<sup>+</sup>

It was, however, not only the power relationships between the Sa'adi and Marabtin which were altered by Italian action but also the power structures within the Sa'adi tribes themselves. Many of the most famous leaders and sheikhs were killed or fled to Egypt during the Italo-Sanusi wars and those who were appointed and financed by the Italians were disliked and distrusted by the Bedouin. Thus a power vacuum was created which was difficult to fill and fundamentally altered

---

1. See Peters.E.L.. The Tied and the Free. p. 23. in Contributions to Mediterranean Sociology.ed. Peristiany Paris 1966.

+ This applies only to the Sa'adi and Marabtin on the plateau. Relationships between these two groups on the steppe were hardly affected by the period of Italian colonisation.

relationships within the tribes. Even after the Italians had been driven out it was a long time before those sheikhs, who had fled to Egypt, returned to Cyrenaica. When they did return they found that their positions had been usurped by brothers or other agnates. In some cases a struggle for leadership developed and the section split into opposing groups.<sup>1</sup>

Today, 1967, the situation is more stable but the power fields of the sheikhs are different from those of traditional Bedouin leaders. The most important sheikhs have been drawn, since Independence, into the non-tribal political system of Cyrenaica. Their power now fluctuates with their political prestige in the central government and is not bound so much by the dictates and demands of their followers. As Libya's wealth increases the power of the central government to control and effect change in the tribes will also increase and the sheikhs will become further removed from their tribal backgrounds.

As the majority of the fighting took place on the Jabal Akhdar and the majority of the land which was appropriated by the Italians was also there it was

---

1. See Peters.E.L. The proliferation of segments in the lineage of the Bedouin of Cyrenaica.p. 48.J.R.A.I. vol. 90.pp. 29-53.1960.

the plateau tribes rather than the steppe tribes which were most affected and most involved in change during and after the period of Italian colonisation. The differences between the Bedouin of the steppe and those of the plateau existed however long before this, in the sense of the greater fertility of the Jabal Akhdar and the plateau Bedouin's consequent emphasis on cultivation and the herding of cattle and goats rather than sheep and camels. This has led to the classification of the Sa'adi into 'steppe' and 'plateau' peoples. I would like to pursue this difference further in the next chapter on the physical background.

### 3 Physical Background

The physiography, vegetation and water resources of the area are important because these factors have a definite bearing on the Sa'adi's subsistence activities and also on the social attitudes, between what can be called the 'plateau' and 'steppe' people. Although all tent dwellers consider themselves Bedouin and therefore distinct from the 'hadhur', town or village people, they do realise that those who live on the Jabal Akhdar are different from those on the steppe, as regards their economy, attitudes and way of life.

If I may be allowed to take a somewhat simplistic approach to the physiography of the region under study, then it may be divided into four sections:-

- 1) The plateaux, Jabal Akhdar and Marmarica (al-Batnan),
- 2) The steppe, as-Sirwal, al-Bult, and ash-Shafa,
- 3) The plains, the Sirte, Barqa al-Baida, Barqa al-Hamra and coastal, and
- 4) The desert.

1) The plateaux.

The northern section of the Jabal Akhdar is divided into three terraces. The first rises from the coastal plain in the north and forms a very steep slope with an average elevation of 800 feet. This terrace is



known as the 'lusaita' (middle part), on which are situated the two towns of al-Marj and al-Abiar. The terrace runs parallel to the coastal plain for about twelve miles.

Above the first terrace is a second, az-Zahir, which has an average height of 1,600', on which is located the ancient Greek city of Cyrene (Shahat). The third and final terrace is much smaller than the other two and reaches a maximum elevation of 2,500' above sea level.

The northern slopes of the Jabal are characterised by the numerous deep wadis and ravines which dissect them and flow towards the sea. This makes east-west movement, apart from on the plateau, extremely difficult and the Bedouin who live in this area, the 'Arafa, Darsa, Hasa, and sections of the 'Abid, Bara'asa and 'Abaidat, form tightly knit, relatively closed communities.. Communication with other camps, not so far removed from their own is restricted. This is especially true in winter when these Bedouin move into the valley bottoms to get protection from the winds and rain. On the other hand the relative fertility of the region means that the population density is greater than on the steppe, and the actual number of contacts within a valley will therefore be the same if not more numerous. The

very frequency of contact has meant a relaxation or disregard of the normally rigidly applied rules of hospitality, for it is obvious that where people are constantly passing through camps the offer of food and the desire for 'news' is not as obligatory or pressing as it is for the people in the relatively isolated steppe camps.<sup>1</sup> Concomitant with this is their concept of distance both geographical and social. The words 'near' and 'far' are used by the Bedouin to express both physical distance and degree of relatedness, and on the plateau both these 'distances' are much smaller than on the steppe.<sup>2</sup>

The Jabal Akhdar slopes gradually southwards through a belt of Juniper until it reaches the undulating steppe country as-Sirwal. The distribution of vegetation on the Jabal varies from place to place according to the distribution of rainfall, the ease of access to subsurface water, thickness of the soil and latitude. The depressions especially during spring have a luxuriant

- 
1. See Peters E.L. 'Physical Environment and Bedouin Way of Life' in *The Sociology of the Bedouin of Cyrenaica*. D.Phil. Thesis. Oxford. 1951
  2. Ibid.

grass cover of mixed grama,, legumes and boragnacea.<sup>1</sup>.

The slopes of the mountains are covered in most places with woods of which the Juniper is dominant.. The Juniper gradually ceases southwards giving way to the steppe.. Tariq Aziza is generally considered the dividing line between the steppe and the mediterranean type of vegetation of the Jabal Akhdar.<sup>2</sup>.

The vegetation, and the existence of relatively abundant rainfall has affected the form of subsistence on the plateau.. Rainfall is reliable and the majority of the springs are located on the second terrace.. This has meant for the Bedouin living there a degree of security and certainty not realisable for the steppe people.. Returns on barley and wheat, although not very large, are constant and pasture, of varying degrees of suitability, is dependable..

The vegetation of Juniper and Lentisk, with oaks and pines associated with Chapparal shrubs and an undergrowth of Grama and Sorgeum grass species, is ideal for cattle and goats but not really suitable for sheep

---

1.. See Hajjaji.S.A.. The New Libya. p.63. Government Printing Press.. Tripoli. Libya. 1967

2.. Evans-Pritchard.E.E.. The Sanusi of Cyrenaica. p.32.. Oxford.. 1949

and camels.. The latter are hindered by the vegetation growth and the sheep damage their fleeces among the low shrubs..

The Marmarica plateau, or al-Batnan, extends from the Jabal Akhdar in the west, to the Egyptian border, in the east.. The area is characterised by a series of low hills in the north, descending southward.. Between the hills are shallow depressions parallel or longitudinal to the coast and also many wadis running to the sea.. The whole of this area is occupied by the numerically most powerful tribe in Cyrenaica, the 'Abaidat.

## 2) The steppe.

This region extends from the plateaux in the north to the Wadi al-Farigh in the south covering the whole of the steppe and semi-desert climatic zones. It is bounded, in the west, by the Barqa plains and, in the east, by the Western Desert.. Within this region there are three distinct areas, the as-Sirwal, al-Bult and ash-Shafa..

The as-Sirwal is characterised by its undulating terrain which slopes gently towards the south. It is dissected by several wadis flowing into the al-Bult.

The al-Bult has as its most notable feature

shallow depressions covered by fine alluvial deposits brought there by the wadis.. During the rainy season (October to April) these depressions become flooded so that in spring they are covered with fine grasses utilised by the Bedouin for their flocks and herds.. The depressions are also ploughed in winter and sown with barley or wheat which can be harvested by the Bedouin in the late spring. As summer advances the soil dries and the grasses are burnt by the sun and finally blown away by the winds. This is the signal for the plateau Bedouin to return northwards to the plateau.

It is in this region, al-Bult, that wells are individually and sectionally owned by people who remain there throughout the year. Water has for them the same significance and importance as ploughland for the people on the plateau.<sup>1</sup> Sections of those tribes, such as the 'Abid, Bara'asa, 'Ailat Fayid and 'Abaidat who move down from the north to take advantage of the spring grasses must be careful not to endanger the livelihood of those living in the steppe permanently and so have to pay for the limited amounts of water which they may use.

The ash-Shafa is the transitional zone between

---

1. Op.cit. p.36

the steppe and the desert, and it is notable for its undulating, stony ground. Rainfall is erratic and grasses relatively scarce so that the region can only be exploited by camel herding Bedouin who have water resources in the area.

The vegetation of the steppe areas varies from north to south. In the north the grasses are taller and denser owing to the relative abundance of moisture and the greater soil fertility. Acacia occupies the depressions and wadi bottoms and depends mostly for its moisture on the wadis which convey water from the mountains after the winter rainfall. It is at this time that the vegetation flourishes and creates grazing for the nomads and semi-nomads who migrate there with their families, flocks and herds.

As I have mentioned above distances between camps, in the whole steppe region, are generally greater than elsewhere and although camps are more widely scattered in spring than in summer or winter contact is frequent and intense. The ease of movement and the demands and expectations of hospitality are such that only enemies would pass a camp without calling in. No real reason has to be given for social calls but as

Peters<sup>1</sup> has mentioned in his thesis the temporary loss of animals, especially camels, is used as an opportunity for visiting and the actual need to find the animals is of secondary importance to that of obtaining news, or strengthening and reviving relationships.

On the plateau, where social intercourse is not so intense unity is achieved by the more frequent use of pilgrimages to Marabut's tombs. There the whole section will gather for a sacrificial meal and the reaffirmation of ties and relationships. Non-attendance by a segment of a section is a public indication of political division and the two groups will gradually move further apart socially and geographically.<sup>2</sup>

Attitudes towards the various aspects of subsistence activities also vary between the steppe and the plateau. On the steppe men are such because of their abilities as pastoralists, whereas agricultural activities are only of secondary significance, a necessity rather than a way of life. Here one is made constantly aware of the importance of animals, especially camels, without which there would be no possibility of occupying much

---

1. See Peters.E.L. The Sociology of the Bedouin of Cyrenaica. D.Phil. Thesis. Oxford. 1951

2.. Ibid.

of the area more than temporarily. On the plateau attitudes are very different. Cultivation forms a much larger part of their total economy and its relative security means that the role of animals is reduced.. The same satisfaction as is achieved on the steppe through the ownership of animals, is not present and the pull of the towns and villages and town and village occupations that much greater. This is particularly true now (1967) because opportunities in the oil industry and on construction sites, especially for the young men, are much more numerous and the demands of education can more easily be met by groups residing more or less permanently near settled communities.

### 3.) The plains.

The Sirte plain lies to the south-west of the Barqa plains, south of the Gulf of Sirte and north of the al-Jofra depressions.. The terrain is mostly flat with gently rolling sand dunes. It is an assembly place for the drainage of the surrounding areas, for example, the Wadi al-Farigh runs from southern Cyrenaica westwards until it reaches the Sirte plain as salt marshes.

The Barqa plains, Hamra and Baida, and the coastal plain stretch from the Sirte in the south to



Tolmeita in the north-east. The north-eastern boundary is well marked by the ridge of the Jabal Akhdar to which it slopes upwards from the coast.

The landscape of the plains is characterised by four features: a limestone outcrop which is exposed at the surface, depressions and wadi mouths which are covered with red alluvial soil, from which the name 'Hamra' is derived, deposited by the winds which sweep the Barqa, marshy depressions of the coast, and finally sandy soil spread over large areas of the plains.<sup>1</sup>

The coastal plain east of Benghazi is notable for its varying extent ranging from narrow beaches at the foot of precipitous cliffs to flat land reaching, at its maximum, a width of twelve miles. As a result of the abundant precipitation and high humidity on the coast the vegetation is of the luxuriant steppe variety interspersed with mediterranean grasses, herbs, and shrubs.

The vegetation of the Barqas is dominated by Juniper, Chaparral, and esparto, whereas the Benghazi plain has various dense species of xerophilous herbs associated with shrubs. Throughout the coastal areas,

---

1. See Hajjaji.S.A. The New Libya. pp.25-26 Government Printing Press. Tripoli.Libya. 1967

but especially in the lowlands near the sea, marshlands are dominant and this is particularly true of the Sirte.

As can be imagined the tribe which occupies the Sirte region and part of the Barqa al-Baida, the Magharba, is predominantly concerned with pastoralism, whereas the tribes further north and east, the 'Awagir, Darsa, and 'Arafa who live on the Barqa al-Baida and coastal plain have a more mixed economy. The Magharba and sections of the 'Awagir can be generally classified as 'steppe' people in their way of life, attitudes and social organization, whilst the other sections of the 'Awagir and the Darsa and 'Arafa are classified as 'plateau' tribes.

#### 4) The desert.

The desert occurs south of the Sirte and steppe and consists of sand dunes and gravelly, barren rolling hills and tablelands. The Libyan desert, not the sand sea area, has grass only in the wadis, basins and marshes. It is practically devoid of perennials because of the insufficiency or lack of rainfall. But it is not unusual to find in rocky or sandy areas annual xerophytic vegetation which bursts into sporadic life

after the episodic rainfall.<sup>1</sup>

This area is only exploited by the most nomadic of the camel-herding Bedouin, such as sections of the Zwayya, Fawakher and 'Ailat Fayid, the former two being Marabtin and not of interest in this present discussion of the Sa'adi.

1. Op.cit. p.64

#### 4 Genealogy and Territory

After the generalisations about the physical environment and the effects which it has on the subsistence activities and internal relationships of the various Sa'adi tribes I would like to make a brief analysis of the Sa'adi genealogy.

The Sa'adi genealogy has two major divisions<sup>+</sup>, the Jibarna and Harabi, below the founding ancestress Sa'ada, and nine minor divisions, which represent the nine Sa'adi tribes of Cyrenaica (see diag. 3 p. 13). The genealogy of each Sa'adi tribe is similarly divided into a number of sections which because they represent the major or first divisions of the tribe have been called 'primary sections'. These primary sections are shown as being related to each other by their founding ancestors' common descent from the eponymous ancestor of the tribe. Each primary section is divided into a number of secondary sections whose ancestors are indicated on the genealogy as being descendants of a primary section ancestor, and these secondary sections are divided similarly into a number of tertiary sections

---

+ For the Cyrenaican Sa'adi

whose common ancestor is the founding ancestor of the secondary section (see diag. 4 p. 45). The tertiary section is thus the lowest division on the genealogy and the smallest unit of the tribe. The members of this section are united on the basis of their agnatic descent from the section's founding ancestor who is at a distance on the genealogy of four to six generations from the living members. The members are thus agnates but also because of the preferential endogamy practised among Sa'adi tribes, cognates. The multiple ties of agnation and affinity which bind each member to the others gives this group considerable cohesion which is furthered by the collective exploitation and defence of a defined territory.

The tertiary section is however not the only division of the tribe which is associated with a territory<sup>1</sup>. Each Sa'adi tribe occupies a homeland or 'watan' which its members own and may defend collectively. This homeland is divided up into a number of territories which reflect the divisions on the genealogy. Thus, for example, if a tribe has two primary sections

---

1. See: Peters.E.L. The proliferation of segments in the lineage of the Bedouin of Cyrenaica.p.30.J.R.A.I. vol. 90.1960.

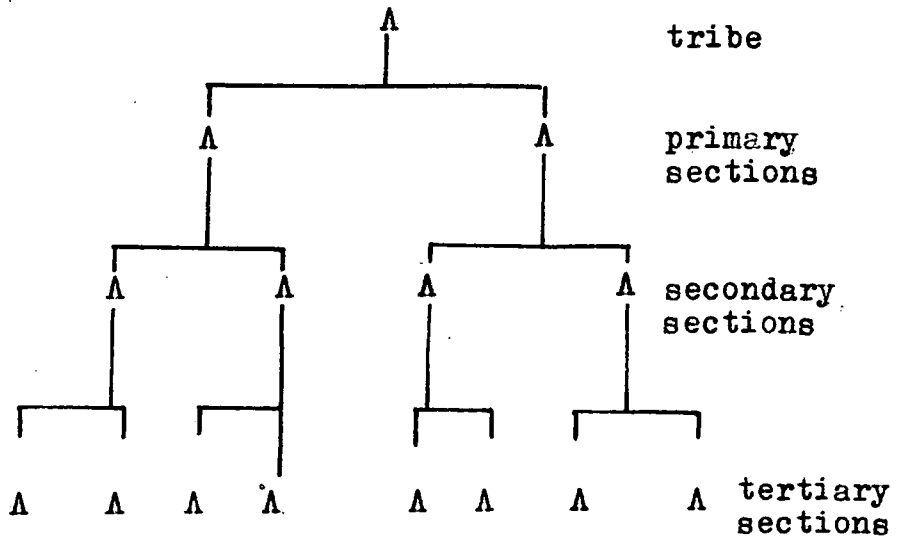

A = founding ancestor of a section

#### 4. TRIBAL DIVISIONS

then its territory will also be divided into two segments, and if one of these primary sections has four secondary sections and six tertiary sections then the territorial divisions will similarly be four and six (see diag.5 p. 47). These territorial divisions and their associated genealogical sections are not haphazardly distributed within the tribal territory. Those sections which are genealogically close i.e. as descendants of one ancestor, will also be territorially proximate. Thus the genealogical sections and territorial segments are interrelated (see diag.6 p. 47).

If as we have seen there is a high degree of consistency between the territorial and genealogical divisions of a tribe and its territory, two questions arise. Firstly where does readjustment of the genealogy take place to cope with the natural increase in members and secondly how can this expansion of population be equated with the geographically restricted territories within which the members of a tribe live?

The Sa'adi genealogy covers between ten and twelve generations<sup>+</sup> from Sa'ada to the living members

---

+ The number of generations for the total genealogy varies from tribe to tribe because the distance between the living members and the founding ancestors of the tertiary sections is variously reckoned as between four and six generations.

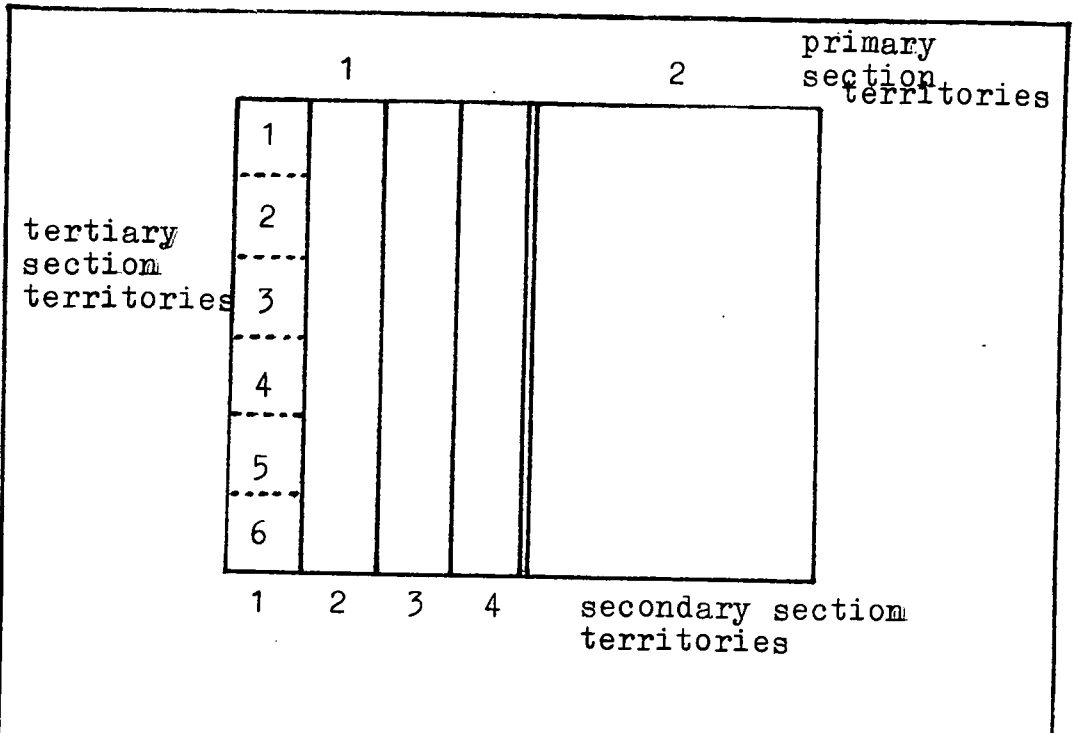

5. TERRITORIAL DIVISIONS OF A TRIBE

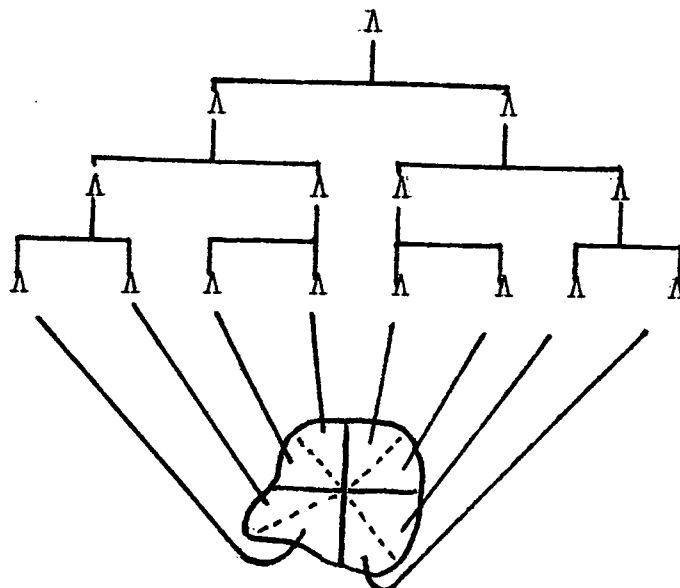

 - TRIBAL territory and territorial divisions

after P.Bohannan  
1954

6. STRUCTURAL AND TERRITORIAL INTERRELATIONSHIPS



of a tribe. However the Sa'adi have occupied Cyrenaica for the last 700 years. Thus the genealogy cannot be a historical account of descent but is merely the Bedouin's conceptualisation of the growth of the Sa'adi tribes in the past. That the genealogy is a concept rather than a representation of reality is further evidenced by the structural uniformity of the genealogies of each of the nine Sa'adi tribes. Each tribe has between two and four primary sections and each of these primary sections has a similar number of secondary sections. It is only at the tertiary section level of segmentation that the numbers of sections assume some conformity with natural reproduction, i. e. they vary considerably from secondary section to secondary section. The division of sections above the tertiary section level would therefore seem to have been dictated by convenience. It would seem <sup>also</sup> from Peters' work<sup>1</sup> that these sections have been little affected by the passage of generations and have thus remained fixed over a considerable period of time. If this is so, then lateral expansion on the base of the genealogy and the addition

---

1. op. cit. p. 38

of generations to it are not compensated for by the vertical movement of ancestors up the genealogy, at least not above the tertiary section level<sup>+</sup>. The mechanism for coping with population growth and keeping the genealogy at a fixed length must therefore exist somewhere between the living members and the founding ancestors of the tertiary sections.

From the evidence available<sup>1</sup>, two major processes would seem to be involved which confirm this assumption. One process maintains the 4-6 generation gap between the living members and the tertiary section's founding ancestor, and the other adds new tertiary section ancestors to those already in existence on the genealogy. The maintenance of this 4-6 generation gap is achieved in a number of ways. Firstly the Sa'adi tribes exhibit a structural feature, similar to that described by Evans-Pritchard for the Nuer, namely 'telescoping'<sup>2</sup>. The Sa'adi often use nicknames

---

+ It could be argued that the Sa'adi need only to expand territorially to cope with population growth. Although this was practised earlier in their history, the establishment of a relatively powerful central government has terminated intertribal warfare. The Sa'adi must therefore cope with expansion within the confines of fixed territories.

1. op. cit. p. 50

2. op. cit. p. 32

instead of given names, and it is these nicknames which if attached to prominent people are given to their sons and grandsons in preference to, or in addition to, the names they received at birth. Once the original nickname holder dies then his son and possibly grandson will inherit the name successively. In this way a number of generations would or could be 'lost' because the one nickname would be placed on the genealogy to represent two or possibly three generations whilst the other given names would be forgotten.

Secondly 'fusion' or the practice of naming a grandson after his grandfather would have similar effects<sup>1</sup>. If, for example, a man was named Hassan and his son Rashid, then the grandson would be Hassan and the great grandson Rashid. All four names would, with the passage of time, be represented on the genealogy with the two names Hassan and Rashid. The intervening names would be 'lost' and the genealogy shortened.

Thirdly the loss of names either through the death of members at a prereproductive age or through disease would also help to maintain<sup>t</sup> the four to six generation gap. The Bedouin generally have a lower

---

1. op. cit. p. 33

resistance to disease than towns people because of their isolation and the absence of readily available medical aid. The distance between camps, especially in spring, means that certain groups can be differentially affected in relation to others. When this happens it is usual, if the dead men have left property, for their agnates to attempt to continue their name<sup>s</sup> by naming their own sons after the deceased members. This however presumes a degree of reproductive success which is not always manifest in Bedouin populations where infant and maternal mortality are high.

Finally it has been fairly common in Cyrenaica for one or two men or sometimes groups of Sa'adi to attach themselves to another tertiary section. The reasons for these attachments are varied but often the cause is a homicide committed elsewhere and the purpose is to seek sanctuary. This is, in the majority of cases, a temporary attachment but some times these men, the 'Laff', will be grafted on to the tertiary section because of marriage into it or through the expressed desire to remain. When this happens the host's genealogy needs to be adjusted to cope with this addition of new

members. Peters<sup>1</sup> found, whilst collecting genealogies, that disagreement over names consistently occurred in the generation prior to the founder of the tertiary section. He called this the 'area of ambiguity' because it was here that the links between the living members and their founding ancestors were most ambiguous. Peters realised that it must be in this twilight zone that readjustment took place and that this would be especially useful for grafts of non-section members. Obviously the section members could not place the new members in a position above their founding ancestor because this would give them structural superiority and to place them lower down would be an obvious falsification of the genealogy. The names were, therefore, most readily attached at about the fourth or fifth generation where there was already, as a result of telescoping and fusion, a degree of uncertainty about the exact relations of past members. Thus the four to six generation gap is maintained even when new members from outside are added to the tertiary section.

The second major process requires flexibility

---

1. op. cit. p. 40, 41

at the apex of the tertiary section to cope with the expansion of population and the resulting division of an over large tertiary section into smaller ones. Theoretically all founders of tertiary sections in one secondary section will be viewed on the genealogy as being related to each other as full brothers of one father. If this were so in practice, a degree of rigidity would pertain in the genealogy which would make it unmanageable because the proliferation of sections could not be indicated. The complexity of lateral expansion would have to be compensated for, and simplified through alterations higher up on the genealogy. As this does not happen, or happens so rarely that the higher levels of segmentation can be looked upon as static then adjustment must take place at the level of the founding ancestors of the tertiary sections.

If, for whatever reason, over population or scarcity of resources, a split occurs within a tertiary section such that the two resulting groups gradually move away from each other and achieve independence, the existence of the new tertiary section must be indicated on the genealogy. Were the new group to maintain its descent from the same founding ancestor as the one

to which it formerly belonged, it would be viewed as being structurally inferior and still attached. The reality of division can only be expressed through the attachment of the new section's ancestor to the genealogy such that he is seen as being a 'brother' of the original ancestor. Thus the proliferation of sections will be indicated at the tertiary section level of the genealogy as a lateral increase in the numbers of tertiary section founding ancestors.

If this process continued unchecked then the founding ancestor of the secondary section would be shown as having a number of sons out of proportion with reality or possibility and some adjustment would have to be made higher up on the genealogy. However this is not necessary because other factors are present which counteract this lateral expansion. As I have indicated above disease can be effective differentially in Bedouin groups. A small tertiary section could thus disappear from the genealogy. If some members survived they would not be in a position to continue the tertiary section and would attach themselves to another section where they would, in time, be grafted on and accepted as descendants of their new ancestor. Similarly a numeri-

cally weak group could be amalgamated into a stronger one through the latter's expansion, or be driven out of its territory and be forced to take up residence elsewhere. In these ways the additions of new tertiary sections could be compensated on the genealogy through the disappearance of others and the make up of the total structure would achieve a type of stability though involved in dynamic change.

We have shown so far that adjustments are made on the genealogy to cope with population expansion, to maintain the length of the genealogy and to counteract the proliferation of sections. The problem, however, as to how population growth can be equated with geographically restricted areas still remains. The first set of answers may be seen from the methods leading to genealogical readjustment such as disease and the expansion of powerful sections. Feuding and warfare, in the past, and the subsequent losses in lives would provide other answers but these activities are no longer possible, or are carried out on a very limited scale in remote areas. The two Italo-Sanusi wars, however, caused considerable losses in lives and stock. These may well have been made up in the intervening years but many of the Bedouin on the plateau did not



return to herding after independence but sought employment in the expanding towns, in the army and police or in construction activities.

Migration from the tribal areas into towns and villages has increased considerably since the discovery of oil and this probably now acts as the major outlet for increases in the Bedouin population. Unfortunately there are no statistics to support this assumption because there is no commonly accepted definition for the terms 'Bedouin' or 'nomad'. Demographic studies which have been undertaken indicate where there has been movement from villages to towns but there is no evidence available for the percentage of Bedouin involved. Even in those cases where estimates have been made they are open to doubt because nearly all statistics for Cyrenaica have been variously described as 'wildly hazardous' and containing 'huge uncertainty'. However it is known that there is a very large immigration of people from Cyrenaica to Benghazi and it is presumed that a good percentage of these must be Bedouin.

Apart from the population controls which may well now keep the Bedouin population in the tribal areas

relatively constant the territories themselves offer outlets in terms of excess pasture, water and ploughland for a larger population. On the steppe there are large areas which do not constitute parts of the Sa'adi tribal territories. This non-tribal steppe is extensively used by the plateau tribes, in spring, as a source of pasture, and enables them to conserve the plateau pasture for the summer when the steppe grasses are exhausted. Thus the density of population on the plateau can be gr<sup>e</sup>ater than the resources of their own territories would seem to permit.

The availability of water in the tribal territories has been a constant problem for a growing population, but now this is being alleviated by the new discoveries of water sources by the oil companies. These wells are particularly valuable for the tribes on the steppe where water has always been scarce whereas on the plateau the higher incidence of rainfall has nearly always been adequate for human and animal needs.

Access to well-watered ploughland which is vital for the Bedouin's mixed economy cannot be solved by movement outside the tribal territories nor has the government attempted to improve those areas of cultivable

land utilised by the Bedouin. It would therefore seem that the needs of an expanding population cannot, as far as ploughland is concerned, be met within the tribal territories. However in the years of sufficient rainfall some increase can be coped with by the periodic bumper harvest on the steppe, and by the relatively consistent but smaller crops on the plateau. The government is also now in a position to import grain to help those tribes affected by drought or crop failure. Thus the territories even as far as ploughland is concerned can cope with some increase in the Sa'adi population.

In conclusion, we have seen that there is a definite interrelationship between the Sa'adi genealogies and the territorial divisions of the tribes and that those sections which are structurally close on the genealogy are also territorially proximate. This correlation, and the fact that the tribes occupy physically and socially defined homelands lead to the questions as to how the genealogy, given an expanding population, can be maintained in its present length, and how the territories, in the absence of aggressive expansion or warfare, can cope with the addition of new members. The answers would seem to consist in readjust-

-ments of the tertiary sections, the sloughing off of excess population through disease and increasing migration, and the possibility of some elasticity in the resource potential of Cyrenaica.

In the account so far I have been concerned specifically with the genealogy and its sections and the territory and its divisions, the stress therefore has been on the lineages which constitute the sections and the territorial segments which constitute the lineages' lands. There are, however, non-Sa'adi Bedouin, the Marabtin, who also exploit the resources of these territories and who act, under certain circumstances, as members of the sections.. This situation has arisen because the Sa'adi, who regard themselves as descendants of the original conquerors of Cyrenaica, the Bani Sulaim, own the land by right of conquest.. Other Bedouin, who belonged to the indigenous population at the time of the conquest or arrived in Cyrenaica later, either had to pay for the right to use the excess resources in Sa'adi territories or paid by services to, and political support of their Sa'adi host sections.. The Sa'adi were then in a position, through the Marabtin's needs, to increase the numerical strength of their own sections, to extend

their power fields by the acquisition of Marabtin groups and to decrease those of others by the 'capture' of their Marabtin. Thus the composition of the Sa'adi sections ceased to be of a purely lineage nature and became a combination of lineage members plus Marabtin groups. It would seem, from what Evans-Pritchard<sup>1</sup> has written that these sections constitute, through fission and fusion, in response to varying degrees of opposition the political system of the Sa'adi. I would like, in the next chapter, to examine this representation of the political system..

1. See Evans-Pritchard.E.E.. The Sanusi of Cyrenaica.  
p.59 Oxford. 1949

## 5 Political System

Evans-Pritchard's field work among the Sa'adi lead him to the conclusion that the Sa'adi's political system was structured in a similar manner to that of the Nuer: 'The tribal system, typical of segmentary structures elsewhere, is a system of balanced opposition between tribes and tribal sections from the largest to the smallest divisions,.....'<sup>1</sup> This view of the Sa'adi's political system can be questioned. I would therefore like, in this chapter, to give first of all a brief account of the political structure as seen by Evans-Pritchard, i.e. as a system of opposition between its sections, then to show, in the light of later field work where this analysis seems inadequate, and finally to present possible alternatives.

We have already seen that a Sa'adi tribe is divided into a number of sections each of which is associated with a definite territory. The smallest of these divisions is the tertiary section and this section collectively occupies, utilizes the resources of, and defends a defined territory. The members of this section

---

1. Evans-Pritchard.E.E. The Sanusi of Cyrenaica. p.59  
Oxford.. 1949

are linked patrilineally by their considered descent from the founding ancestor of the section, and they are also, because of the high percentage of endogamous marriages (48% <sup>1.</sup>), consanguineally linked.. Thus relationships between the members are extremely close and provide for the highest degree of cohesion within the group.. They are further tied to each other by the responsibility which each member bears for avenging the death of another member or being killed for a murder carried out by another member. The concentration of these agnates within their tertiary section's territory is very high (80% <sup>2.</sup>).

Often Sa'adi from the same tribe or other tribes are attached to these lineage members either because their sections have been reduced to uneconomic units through disease or, because they have sought refuge.. These men, the 'laff',, may be incorporated into the section through marriage (8% of the total percentage of marriages within a section <sup>3.</sup>) or by participation in conflict with other sections.. There are also Marabtin

---

1. Peters.E.L.. Aspects of the Family among the Bedouin of Cyrenaica. p.140 in: Comparative Family Systems. chap. 7 Nimkoff.. Boston.. 1965

2.. Op..cit.. p.. 132

3.. Op..cit.. p. 141

groups attached to Sa'adi tertiary sections for the purpose of utilizing the excess resources of the sections' territories. These men will, if their Sa'adi patrons are threatened or opposed by another Sa'adi section, take part in the conflict in support of their patrons. The Sa'adi will similarly defend their Marabtin should the latter come into conflict with Sa'adi from other sections. The strength of the Sa'adi/Marabtin ties will, of course, depend on the length of time which the Marabtin have used or can expect to use, the Sa'adi's resources and also on the degree of intermarriage between patrons and clients. Normally, however, these ties are sufficient to ensure some degree of Marabtin participation in external conflict. Thus the tertiary section, composed of lineage members, 'laff' and Marabtin, constitutes the smallest political unit of a Sa'adi tribe.

According to the theory of segmental opposition the tertiary section would act as a unit in opposition to similarly sized, similarly structured units. We have seen that the members of a tertiary section are responsible for each other's 'blood' and thus if a member of one section were killed by a member from another then all members of the murdered man's section



would combine to exact vengeance on the members of the murderer's section.. Similarly if conflict were to exist between the members of two tertiary sections from different secondary sections then theoretically all the members of one secondary section would oppose all the members of the other secondary section. The basis for coalescence would be their common descent from the founding ancestors of their respective secondary sections. These sections could, in turn, combine on the same basis as a primary section in opposition to another primary section of the same tribe through the conflict of members of tertiary sections in these two primary sections. Finally one tribe could oppose another tribe on the basis of the opposition of their members (see diag.7: p.65).. Once the conflict was at an end the reason for the temporary unity of these larger sections would disappear and they would break up into the smallest units of the tribe i.e. the tertiary sections.

The length of the hostile activity is controlled by the geographical proximity of the sections involved.. Adjacent tertiary sections cannot long remain opposed to each other because, among other reasons, the demands of a pastoral economy necessitate movement of

## .7. THE BALANCED OPPOSITION OF SECTIONS

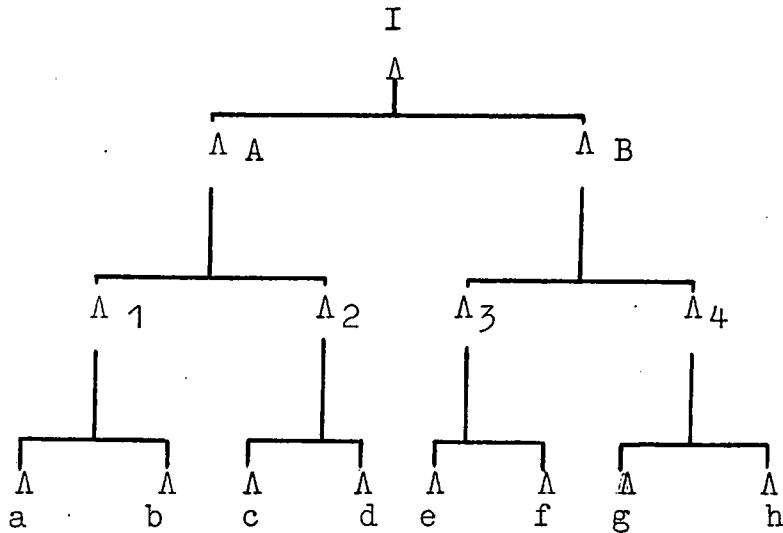

If a member of tertiary section 'a' came into conflict with a member of tertiary section 'b' then all the members of 'a' would oppose all the members of 'b'. If, however, a member of 'b' came into conflict with a member of 'c' then 'a & b' as '1' would oppose 'c & d' as '2', because 'a & b' are the descendants of the secondary section ancestor '1' and 'c & d' of the ancestor '2'. If a member of 'd' opposed a member of 'e' then 'a,b,c,d' would combine as primary section 'A' against 'e,f,g,h' as primary section 'B'. Finally 'a,b,c,d,e,f,g,h', as tribe 'I' would oppose all the tertiary sections of tribe 'II' should their members conflict.

men and stock across the boundaries of their territories. Also the members of both sections are viewed as being the descendants of two 'brothers' and one 'father' and are thus so close that their relationships should be characterised by harmony rather than conflict. Agreement of one kind or another must therefore be reached quickly. On the other hand conflict between sections geographically and therefore structurally removed from each other would cause less disturbance to normal activities and can therefore be more bitter and protracted. Consequently the nature and length of the opposition is determined by the geographical and structural proximity or distance of the sections in conflict.<sup>+</sup>

In conclusion, we have seen, that sections at every level of segmentation can oppose each other, that the length and nature of the conflict is determined by the structural and geographical distance between the opponents, and that, on the termination of conflict or in its absence the tribe returns to, or is composed of,

---

+ This is reflected in the nature of hostile relationships between sections. Opposition between tertiary sections of the same secondary section is characterised by vengeance and blood money, that between secondary sections with feuding, between primary sections with raiding and between tribes with warfare.

its smallest political units, the tertiary sections. Thus fusion or the amalgamation of sections is counter-balanced by fission or the division of sections.<sup>1</sup>

It would seem from Peters field work (1949-1950) and from my own (1967) that this view of the Sa'adi political system is inadequate and "does not provide an admissable basis for analysis."<sup>2</sup>

Segmentary opposition and the fission and fusion of like parts presumes equality in the numbers of members of sections, the sizes of their territories, and the numbers of sections in larger groupings. From Peters field work<sup>3</sup> such a presumption cannot be supported by the facts. Firstly the population of tertiary sections varies considerably throughout Cyrenaica and correspondingly the size of the territories which they occupy is quite dissimilar.<sup>4</sup> Some tertiary sections are therefore able to, and do, dominate others in a way which cannot be accounted for by 'balanced opposition'. Thus the sections may be structurally equal on the genealogy but

- 
1. See Evans-Pritchard.E.E. The Nuer of the Southern Sudan. p.284 in: African Political Systems.ed.Portes and Evans-Pritchard. Oxford 1940
  - 2.. Peters.E.L. Some structural aspects of the feud among the camel-herding Bedouin of Cyrenaica. p.279. Africa vol.. xxxvii no.3 July 1967
  3. Op.cit.. pp.270-272.
  4. Op..cit. p. 271

cannot be treated as equivalent political groups.. Secondly the numbers of tertiary sections in the various secondary sections of a tribe are variable<sup>+</sup> and the relationships between two secondary sections would be dictated by that section which was numerically more powerful.

Also the segmentary lineage theory would indicate that for sections larger than the tertiary section to exist as political groupings they would need to be in a constant state of hostility.. Such a situation would be impossible in Cyrenaica where the demands of a pastoral existence necessitate freedom of movement across section boundaries.. Further it is questionable whether sections larger than the tertiary section have ever acted corporately.. It is known tha<sup>t</sup>, in the past, there were wars between confederations of tribes for example the Harabi and 'Aulad 'Ali, between tribes, the 'Abaidat and Bara'asa and between secondary and primary sections of tribes but whether all the members of these tribes or sections ever opposed all the members of the others is open to doubt. Certainly today (1967) the larger groupings do not act together and Peters has written that this was

---

+ See chap.. 4 p.48.

also true during the period of his field-work<sup>1</sup>.

One of the reasons for the absence of some members or some sections from the secondary or primary sections to which they belong when these are involved in conflict is the existence of affinal or maternal ties between those groups opposed to each other. Although Sa'adi tribes practice preferential endogamy 28 %<sup>2</sup> of the total marriages of a tertiary section are with other sections of the same tribe and 7 %<sup>3</sup> are with other Sa'adi tribes. These links are geographically widely distributed because one of the reasons for their existence is to provide access, or a claim to the resources of other sections or tribes. As the majority of Sa'adi live on the margins of existence such links can be of vital importance in times of pasture or water shortage and crop failure. The potential resources available to tertiary section members is increased by these external marriages and the viability of the group as an economic unit is improved. Another reason is that the ties thus created provide a potential source of support in political conflict with other

---

1. op. cit. p. 278

2. Peters.E.L.. Aspects of the family among the Bedouin of Cyrenaica.p.140 in: Comparative Family Systems.Nimkoff Boston 1965

3. op. cit. p. 141

sections. Thus if sections with such links were called upon to oppose other sections some of whose members were affinal or maternal relatives they would generally refuse because participation would endanger vital ties. The Bedouin 'do not feud with cognatic relatives'<sup>1</sup>. The importance of these cognatic links indicates two major weaknesses in the segmentary theory of opposition. Firstly a segmentary political system with its emphasis on agnation and patrilineality takes no account of the political role of women and secondly balanced opposition between all the members of like sized groups manifestly does not occur.

Another objection to a segmented political system is that it excludes the possibility of external influences on the tribal system. Gellner, in his article 'Saints of the Atlas'<sup>2</sup> sees tribes, in North Africa, as dissident, or marginal groups existing on the periphery of wider urban, or non-tribal societies. Although they are part of a wider political system in the sense that national boundaries enclose them, they have, to a

- 
1. Peters.E.L. Some structural aspects of the feud among the camel-herding Bedouin of Cyrenaica.p.275.Africa. vol. XXXVII.No.3. July 1967
  2. Gellner.E. Saints of the Atlas. in Mediterranean Countrymen. ed. Pott-Rivers. Mouton Paris 1963

certain extent, opted out of this system through resistance and geographical isolation. Nevertheless they are aware of a wider world and have adapted themselves to it. They, therefore, cannot be seen in isolation but as 'part societies' very different from the more holistic units in Africa south of the Sahara. In Cyrenaica the autonomy of political action, in the tribal areas, is restricted by outside interference and the Sa'adi political system functions in a manner very different from that of the periods when the tribes' autonomy was complete. The discovery of oil, the resulting dramatic social change, and the increasing power and influence of the Central government have meant that the centres of power have moved from the tribes to the government. Also, the traditional political institutions of the tribes have been replaced by administrative forms more suited to the central administration. For example, the role and status of the sheikhs have been altered by the need of the government to act through them in its dealings with the tribes and some sheikhs have been incorporated into the power structure of the government. Such changes in the political make up of the tribes, increasing contacts with external influences, decreasing geographical isolation and greater involvement



with the wider society are factors which cannot be ordered into an exclusive political system based on segmental opposition, fission and fusion.

We have seen so far that political groupings superior to the tertiary section, i.e. secondary sections, primary sections and tribes only exist as named lineages on the genealogy and as territorial units. These groupings may have come together as political units in the past but most probably were not composed of all the available members, or sections, and dispersed once the reason for coalition had disappeared. Also balanced opposition between similarly sized, similarly structured sections cannot be equated with the present composition of sections. Further a lineally based political system takes no account of the political role of women in the society. And finally we have seen that the political system and the sections which constitute it cannot be abstracted, or seen in isolation from the 'wider society'. It would therefore seem that Evans-Pritchard's analysis of the Sa'adi political system and his view of the constitution of its groups are untenable. It thus remains to present some alternative groupings.

A basis for alternative political groupings could be the tertiary section. This section is, as we have seen, a named <sup>+</sup> lineage group whose members are tied to each other by agnatic and cognatic links, the common exploitation and defence of a defined territory, and the responsibility for the 'blood' of other members. Internal authority is in the hands of the section's elders and sheikhs who come to decisions on the basis of consensual opinion and act as the intermediaries and leaders in the group's relationships with other sections. Other Bedouin, the Laff and Marabtin, who live within the territory of the section and utilise its resources combine with the lineage members when the section is faced by outside pressure or is competing with other sections for resources. The tertiary section therefore possesses all those attributes necessary for a political organisation as defined by Radcliffe-Brown<sup>1</sup>. A Sa'adi tribe can thus be seen as being divided into a number

---

+ Named after the founding ancestor of the section.

1. 'The maintenance or establishment of social order, within a territorial framework, by the organised exercise of coercive authority through the use, or the possibility of use, of physical force'. Radcliffe-Brown. A.R. The Preface p. XIV in African Political Systems. eds. Fortes and Evans-Pritchard. Oxford 1940

of autonomous political units. This does not mean, however, that these tertiary sections are politically identical, i.e. that there is a balance of power between all of them. Their size, influence and power-fields will increase or decrease according to a number of factors.

Firstly the size of the sections in terms of numbers of members and of territory occupied varies considerably. The members of tertiary sections number between two hundred and seven hundred <sup>1</sup>. and some sections' territories are two or three times the size of others.<sup>2</sup> With a preponderance in numbers and larger resources some sections will inevitably be able to dominate others. Dominance, however, may be short lived because the non-agnatic ties between the members of a very large section can be weakened by dispersion or be polarised around contesting leaders or sheikhs. In this situation the murder of a section member by another member, or the inadequate return of a debt, for example, could lead to a split and the resulting two sections may, as single units, be dominated by another slightly larger one.

- 
1. Peters.. E.L. Some structural aspects of the feud among the camel-herding Bedouin of Cyrenaica. p. 262. Africa. vol. XXXVII. No.3. July 1967
  2. op. cit. p. 271

Secondly the varying ability of sections to support Marabtin affects political relationships and power fields in a number of ways<sup>1</sup>. Declining tertiary sections can, by the acquisition of Marabtin, restore their numbers and prevent territorial encroachment by other sections. Sections striving for dominance can achieve this by the further addition of Marabtin or the 'capture' of a rival's Marabtin groups. Sections whose resource potential has decreased through lack of rainfall or crop failure may be forced to exclude their Marabtin from the use of the remaining resources in order that the needs of agnates and cognates may be met. The Marabtin faced by the necessity of finding alternative resources for their flocks and herds will join another Sa'adi section. The former hosts will be weakened and the new patrons will receive an addition which can alter their power relationships with other Sa'adi sections. Thus the influence and power of Sa'adi sections will fluctuate with the addition, capture or expulsion of Marabtin groups.

---

1. See Peters.E.L. The Tied and the Free. pp. 25-31 in: Contributions to Mediterranean Sociology.ed. Peristiany Paris 1966

Thirdly external marital links with other sections can alter the distribution of power among tertiary sections<sup>1</sup>. This is effected in two ways. Firstly these affinal and maternal ties enable the sections to have access to resources otherwise unobtainable and, in times of pasture or water shortage, they can be utilised to preserve the integrity of the section. Thus the consequent increase in the economic viability of the group enables it to compete more successfully politically. Secondly the strengthening and reaffirmation of these ties over a number of generations changes the content of the relationships so that they become political as well as economic. Tertiary sections so linked will not oppose each other, they will, in fact, combine against prospective opponents. The political validity of the tertiary sections, will, therefore, also vary with the number and strength of external ties to other sections.

Finally leaders or sheikhs in the sections freed, through their relative wealth, of the need to create purely economic ties with neighbouring sections

---

1. Peters. E.L. Some structural aspects of the feud among the camel-herding Bedouin of Cyrenaica. p.274. Africa. vol. XXXVII. No.3.1967

will be able to marry into sections for political purposes. Thus a powerful and wealthy sheikh can, through polygamy and the manipulation of the marriages of his sons and daughters, establish numerous links with other sections. These he can use to extend his own power and influence and that of his section because the ties can provide the reasons for alliances and combinations against other sections.

There are also Sa'adi sheikhs who have been drawn into the power structure of the government. Such men with the additional wealth and support of governmental office can create political groups based only on the strength of their personal power fields and kinship connections rather than on tertiary sections. There is, however, little evidence to support this statement apart from Peters' comment that 'there are men who wield power over varying populations, ....' and 'that the extent of their domains cannot be understood by reference to orders in the lineage' <sup>1</sup>. If this is the case then such leaders and their groups could provide, apart from the tertiary sections, other alternative political groupings. In the absence of more

---

1. op. cit. p. 271

explicit information it is impossible to place too much faith in this alternative and such sheikhly groupings must remain as tenuous possibilities.

It can, I think, be seen from the above that the nature of relationships between tertiary sections will be affected by the variables of numerical and territorial size, the addition or subtraction of Marabtin, the number and strength of marital links and the individual power fields or sheikhs. The competition for resources and the desire for political dominance among these tertiary sections will stimulate them to utilize their relationships and ties with other sections for the formation of larger groupings. These groupings, I would suggest, constitute the Sa'adi political system. However, as they are affected by, and form part of the 'wider society', it is impossible to talk about the Sa'adi political system as an exclusive single structure. It is, what might be called, a 'part-political system', a segment of a wider system which embraces the Sa'adi, the settled communities of Cyrenaica and the Marabtin.

## Part Two

### 6. The Marabtin in General

The Marabtin constitute about 14% of the Bedouin population of Cyrenaica.. They are divided into at least sixteen named tribes whose members and territories are scattered over the whole of Cyrenaica.. Only two or possibly three of these tribes the Fawakher, Zwayya and Qitarna can be defined as tribes in the political sense because of their ownership and occupation of resources and defined territories. The members of other Marabtin tribes only have named ancestors in common and are divided into small groups, often geographically widely separated, attached to sections of Sa'adi tribes. They regard themselves primarily as members of their Sa'adi sections and are only classified as members of named Marabtin tribes by the Sa'adi and the anthropologist..

The origins of the Marabtin are by no means certain but various historical explanations have been put forward to explain their existence in Cyrenaica and the nature of their present relationships with the Sa'adi.. The word 'Marabtin'' offers some explanation



because it is generally considered as coming from 'ribat', a fortified place in conquered territory, whose warrior occupants were called 'Murabitun' or 'Marabtin'.<sup>1</sup> This would seem to indicate that the word was first used to describe the Muslim invaders of the 7th. century who moved into and occupied north Africa.. Once in north Africa they tended to marry into the indigenous population, because unlike the later invaders, these men did not come with their wives and families. Thus the present day Marabtin population is the result of an Arab-Berber admixture first begun in the 7th. and 8th. centuries.. When the Bani Hilal and Bani Sulaim invaded in the 11th. and 12th. centuries these Marabtin became dependent on the Sa'adi and 'Marabtin' became the name for dependent people..

Another explanation which has been advanced is that they are the descendants of the Almoravides, a Muslim dynasty which reached the height of its power in the 11th. and 12th. centuries.<sup>2</sup> This dynasty was founded by several branches of the Sanhadja, a large Saharan tribe, which under its religious leader invaded and

---

1.. See Murray .G..W. Sons of Ishmael.. Routledge. p.271 1935

2. See The Encyclopaedia of Islam. 1. A-D 1913

conquered the Maghreb in the first half of the 11th. century.

The movement was started by the chief of the Sanhadja, who, on returning from a pilgrimage, met the professor of Malikite law, Abu Imran al-Fasi, in Kairawan. The chief asked al-Fasi to provide him with someone who could teach his tribe the Muslim doctrine. Abdallah ibn Yasin was chosen and sent from Kairawan. He settled with his companions on an island in the Niger to which came large numbers of followers. The convent which was built there was called a 'ribat' and the followers 'Murabitun', a name which later became corrupted, in Spain, to Almoravides. The devotion and warrior qualities of the disciples soon subjugated the peoples surrounding the convent, and wars of conquest lead to the acquisition of the Maghreb and Muslim Spain. The dynasty was finally destroyed by the Almohades in 1146 when they captured the capital, Marrakush. However by this time the warrior monks, Murabitun, and their ideas were already spread throughout most of north-west Africa. It seems from what Hagopian<sup>1</sup> has written about Morocco that the Marabtin

---

1. Hagopian.E.C. The status and role of the Marabout in pre-Protectorate Morocco. Ethnology. vol. 3. no.1 pp. 42-45.

became less concerned with the intellectual content of Islam and more preoccupied with a mystical interpretation. As a result the tombs of Marabtin, their clothes, and anything which they touched was considered to contain supernatural power which facilitated beneficent acts.

Beginning in the 13th. century and lasting until today there was a movement of these Holy Men from the west towards the Holy Cities of Islam. As they moved eastwards they spread the ideas and traditions which had been developed in the Maghreb and these can be seen today in the respect given to Holy Men and the worship of their tombs. Such men and their families settled in Cyrenaica and it is believed gave rise to some of the present Marabtin tribes.

Finally there is a sociological rather than a historical explanation for the existence of some Marabtin groups and sections. Peters has written that 'whether a section is considered as Marabtin or not, is not so much a problem of historical origins but of known existing relationships between groups.'<sup>1</sup> The Sa'adi generally are not concerned with, or interested in, the

---

1. Peters.E.L. The Sociology of the Bedouin of Cyrenaica. D.Phil. Thesis. Oxford. 1951

historical origins of the Marabtin. The Marabtin are such because they are not Sa'adi, that is they cannot claim descent from the eponymous ancestress Sa'ada, and thus have no inherent right to the use of pasture and water which the Sa'adi obtained by conquest. All strangers are classified as Marabtin irrespective of their historical background and because they have to seek the permission of the Sa'adi to water and graze their flocks and herds they have become dependents. Thus the word Marabtin is synonymous with 'client' and describes the role and status of these people when compared with the 'patron' Sa'adi. However it is clear that this relationship can only exist where there are dependent clients and those Sa'adi sections which have no Marabtin to throw them into relief as patrons may have their 'nobility' questioned<sup>1</sup> and finally lose their status. Similarly a Sa'adi section which loses members through high infant mortality, an epidemic or the failure of resources may find itself forced into a position of dependency on another Sa'adi section. If this continues the relationship becomes established and the section becomes class-

---

1. See Peters.E.L. The Tied and the Free. p.32 in: Contributions to Mediterranean Sociology. ed.Peristiany. Paris.. 1966

-ified as Marabtin by the nature of its perceived relationship to the patron Sa'adi section. Although this is a relatively rare occurrence it does happen and indicates a type of social mobility which is not at first apparent.

The word Marabtin, as it is used today, is a generic one and does not indicate the differences which exist between Marabtin groups and the differences in relationships which occur between these groups and the Sa'adi. The Marabtin are divided basically into two groups, the Marabtin as-Sadqan, from 'sadqa', fee, and the Marabtin bil-Baraka, or the Marabtin of the 'goodness'<sup>1</sup>. The basis of this distinction has much to do with their historical origins. The Marabtin as-Sadqan are considered to be the descendants of the 7th. century invaders and the autochthonous Berber, and the Marabtin bil-Baraka are seen as being the present day representatives of the Holy Men who started moving eastwards from the Maghreb in the 13th. century.

The Marabtin as-Sadqan are generally those who pay fees for the use of pasture, ploughland and

---

1. 'Baraka' is 'the divine blessing bestowed on a man, by virtue of his birth and origin, and is made manifest in the good works of its possessors.' from Peters.E.L. The Tied and the Free.. p.2.in Contributions to Mediterranean Sociology.ed.Peristiany. Paris. 1966

water which are owned by the Sa'adi tribes. It is however doubtful whether they ever paid, or were expected to pay, a fee because it could be obtained indirectly through requests, by the Sa'adi, for blood money contributions and the donation of animals for guest meals. The Marabtin do not supplicate for the use of those resources which are temporarily in excess of the needs of the Sa'adi section but are brought into the section's territory at the request of the elders, when a temporary imbalance in population or livestock is perceived. If, for example, the elders found that there were insufficient young men for herding, old men for entertaining, or livestock for the utilization of resources then they would try to obtain a group of Marabtin which would fulfill their requirements.

The length of time that the Marabtin would remain attached to a Sa'adi section would depend upon the continuation of the imbalance in Sa'adi man power and resources. Once there was an increase in the numbers of Sa'adi agnates resident in the territory, or a decrease in the amount of available pasture or water, the needs of the agnates would be placed before those of any Marabtin group which might be attached to the section.

The elders would try, first of all, to alleviate the situation by making use of affinal and maternal links established elsewhere, but if these proved insufficient then the Marabtin would be forced to depart. This measure is implemented with considerable reluctance by the Sa'adi patrons because it involves a loss of strength and prestige for their whole group.

This can readily be appreciated if it is realised that the Marabtin play an important part in the power structure of Sa'adi politics. The Sa'adi own and control access to water, pasture and ploughland, all of which are vital for a pastorally dominated economy and society. The exercise of their managerial control over resources enables the Sa'adi sections to increase their power fields either by establishing links with other Sa'adi sections, giving them the right to utilise excess resources, or by attracting Marabtin groups whose men and livestock increase the political power of the patron section. The Marabtin can be relied upon to support their Sa'adi patrons either in the form of armed men, or as a block vote for the election of a Sa'adi to political office. If the Marabtin are forced, through shortage of resources, or an increase in the

man power of a Sa'adi section, to vacate that section's territory then it will involve the Sa'adi in a two-fold loss. Firstly they will lose the political support of their Marabtin and secondly, because the Marabtin will of necessity seek resources elsewhere, the Marabtin will be drawn into the power field of another Sa'adi section with which the original patrons may be in opposition. Thus there will be a double blow to the political aspirations of the original patron group, the loss of support and the strengthening of another section with whom they are competing for political power.

The Marabtin are disqualified from having political desires themselves because they are not in control of the sources of power, water and land. Also any excess wealth which they may produce is chanelled<sup>n</sup> off into the Sa'adi section of which they are clients. However because of the part they play in the political system of the Sa'adi they do possess a lever which enables them to gain access to resources which are vital for their continuance as groups. Although, therefore, they may be forced to be highly mobile, to possess no definite territory, and to be divided up into small sections concomitant with the scattered resources



available to them, they possess strength because of the Sa'adi's political needs, and are therefore an integral part of the political system of the region.

I have so far discussed the situation and interplay of relationships which face the majority of Marabtin as-Sadqan. There are however other Marabtin groups whose relationships with the Sa'adi are different because some constitute large and powerful groups attached to Sa'adi sections remaining more or less permanently in one territory, and others form Marabtin tribes which are, to all intents and purposes, independent of Sa'adi control and which occupy their own distinct territories.

These large and powerful groups, attached to Sa'adi sections, are often the strongest and politically most active in a Sa'adi tribe. Obviously in these cases the relationships between the Sa'adi and Marabtin are very different from those generally applicable to patron/client relations. This situation arises either where the numbers of Sa'adi in a section have dropped to a level incommensurate with the defence of their territory and protection of their resources, thus forcing them to bring in a large number of Marabtin, or were

the original number of Marabtin and their livestock have increased to a point where they constitute a majority in a particular section's territory. This has happened in a number of areas in Cyrenaica and Evans-Pritchard<sup>1</sup> has mentioned the case of the 'Ailat Hadduth, the leading section of the Bara'asa tribe, which numbers 2,520 persons of whom only 630 are true Bara'asa, the remainder being Marabtin. Although these Marabtin do not have full Sa'adi status the relationship between them and their patrons is one of mutual dependence. They cannot be forced out by the section's Sa'adi agnates, and help from outside whilst it might be successful in achieving the expulsion of the Marabtin would leave the patrons in danger of being absorbed or forced out in turn, by their Sa'adi assistants. Thus the position of these Marabtin is relatively secure and they can, through their permanent residence in one territory, indulge in all those activities normally the prerogative of the Sa'adi, although never achieve their status.

Marabtin tribes occupying distinct territories may be seen as forming the end result of a process from dependence, through interdependence to independence. Although it is sociologically unsound to imply an

---

1. Evans-Pritchard. The Sanusi of Cyrenaica. p.51.  
Oxford 1949

evolutionary development to explain the current differences between Marabtin as-Sadqan, it can be seen that the independent Marabtin tribes could well have arisen from large and powerful groups attached to Sa'adi sections. Such groups could lay claim to wells and ploughland, as has happened in Cyrenaica<sup>1</sup>, and drive off the patrons. Their successful control of natural resources, particularly water, would enable them to exercise managerial rights over it, and to attract to themselves an increasing number of dependents, thus extending their power field much as the Sa'adi do. The end result of this process is the creation of a defined territory and the acquisition of true tribal status. Examples of such tribes are the Qitarna and Zwayya.

The term Marabtin as-Sadqan therefore is not a unitary one, at least for the anthropologist, because the word covers a wide range of people whose relationships, and political and social status, vary considerably throughout Cyrenaica. They constitute small, fragmented ethnic groups, large sections of noble tribes, and relatively powerful independent tribes.

---

1. Peters.E.L. 'The Tied and the Free'. p. 14. in Contributions to Mediterranean Sociology. ed. Peristiany. Mouton & Co. Paris 1966

The second class of Marabtin, the Marabtin bil-Baraka, constitute 11% of the Marabtin population of Cyrenaica<sup>1</sup>. As I have mentioned above they claim descent from the Holy Men who moved eastwards towards Mecca and Madina. Many of them did not reach their destination and remained in various places in North Africa en route. Those who settled in Cyrenaica were accepted as Holy Men because of their knowledge of the Koran, writing and reading and their ability to cure the sick. The more famous and successful drew followers to them and these together with their families formed the basis of the present tribes. When they died monuments were erected above their graves and it was, and is, believed that these possessed the properties of the dead men. As a result their followers continued to live in the neighbourhood of these tombs, became associated with a particular place and took the names of the dead men as tribal or group names.

The Marabtin bil-Baraka, unlike the Marabtin as-Sadqan, are not expected to pay a fee for the land which they occupy firstly because of their baraka and the services which they could offer, such as the care

---

1. op. cit. p.3

of the sick and succour of the poor, and secondly because that land which they were given was often disputed territory on the borders between two Sa'adi tribes or two Sa'adi sections.

The services which the Marabtin bil-Baraka are able to provide are many and varied and usually performed by the males of one or two families who reside in Sa'adi territory. Although they are able to perform those normal duties expected from religious men such as regular prayer, the exorcism of the evil eye, and the writing of charms they also officiate at peace meetings after a homicide.. They would be asked to intervene by the disputant parties and because they were not structurally part of either group their help is looked upon as more impartial.. They would bring the parties together, witness the amount and nature of the compensation, and recite the 'fatiha', the opening surra of the Koran, at the conciliatory meal.. They are felt to make the peace more lasting as well as enabling the victim's group to accept blood money, rather than vengeance, without loss of pride or status. They also participate as religious officials at ceremonies when all members of a lineage gather together at a Marabat's tomb to pledge and

reassert their allegiance and unity.. They thus fulfill vital functions in the social life of the Marabtin as religious leaders, arbitrators and intercessors.

Those Marabtin who occupy land between Sa'adi tribes usually consist of larger named groups than those attached to Sa'adi sections although they are not structured or segmented in the same way as the Sa'adi because they do not possess a patrilineage. Disputes on the borders of Sa'adi tribes were, and are, a constant occurrence because no definite boundaries were ever established especially between tribes inhabiting the Barqas, or the steppe.. As a result there were areas of no-man's land which could be claimed by adjacent tribes both as a method of territorial expansion and as a sounding board for the strength or weakness of the respective tribes. If these disputes were protracted and lead to violence, the Marabtin bil-Baraka were called in to bring about a settlement. Often it would be decided that the Marabtin should be given the disputed area thus solving the problem and creating a buffer zone between the two Sa'adi tribes.<sup>+</sup> These Marabtin also provided the

---

<sup>+</sup>This practice was followed when the Sanusi established themselves in Cyrenaica. Lodges were built between the tribes enabling the Ekhwan to administer two tribes and two territories..

services mentioned above, and in return the Sa'adi would often plough their land, and harvest their crops, if they were short of labour, and as a way of repaying a debt for the treatment of the sick, or intervention in a conflict situation.

As we have seen the Marabtin bil-Baraka form only a small percentage of the Marabtin and generally are scattered in families, or small groups, at least in comparison with the Marabtin as-Sadqan, throughout Cyrenaica. Unlike the Marabtin as-Sadqan they do not seem, at least from what Evans-Pritchard and Peters have written and what I was able to learn, to have political aspirations, the incentive or desire to become integrated into the Sa'adi, or the wish to possess their own land and distinct defined territories as the first step towards true tribal status. This may be because they already possess sufficient prestige from their positions as religious men and because their status or economic position could not be improved by becoming Sa'adi. It is therefore rather surprising to find one Marabtin bil-Baraka tribe, the Fawakher, occupying their own socially and physically defined territory entirely independent of Sa'adi control. They are also structured in the same

way as a noble tribe with a recognised patrilineage and sectionally segmented territories. I hope to be able to give some explanation for this apparent anomaly below and to show why they have remained Marabtin although possessing all those attributes associated with Sa'adi tribes.



## Part Three

## THE FAWAKHER

## I. General

7 Historical Background

The Fawakher, unlike other Marabtin tribes, do not accept for themselves any of the interpretations which have been formulated to explain the existence of the Marabtin in Cyrenaica. They reject the idea that they are either the descendants of the Yemeni mercenaries who first invaded North Africa in the 7th. and 8th. centuries, or descendants of these invaders and the indigenous Berber peoples.. They say that they are descended from the Prophet Muhammed, and prove this by reference to their genealogy which they trace back to Muhammed himself. This would exclude them from being of Yemenite origin, and the pride of 'blood' which this would confer would prevent any admixture of Berber blood. Their considered descent would make them Marabtin ' 'ashraf', or noble Marabtin, and also Marabtin bil-Baraka, because of the divine grace or blessing which would be bestowed upon them by virtue of their birth and origin.

There is no way of verifying their claims

because there is no recorded history which could throw light on the subject, and it is fairly common throughout the Muslim world to claim a genealogical connection with the Prophet. This does not mean that they are not descendants of Muhammed but that it is open to debate because many groups have aspired to this status and some have achieved this, not through the genuineness of their claim, but through their persistence in its validity and the adoption of behaviour commensurate with noble descent.

If we accept their noble origin the question still remains as to how and why Fakr, the founding ancestor, arrived and settled in Cyrenaica. It seems to me that the most valid explanation, and one which would concur with their own idea of their status and position in Cyrenaica, would be that they are the descendants of the Holy Man Fakr who was moving back from the west, possibly Algeria, on his way to Mecca at some time during the 13th. century. This explanation would question their rejection of Yemeni origin but would be in agreement with their other propositions. Firstly they regard themselves and are classified by the Sa'adi as Marabtin which connects them irrevocably with the original warrior

invaders who manned the 'ribats' or fortified posts in the conquered territories. Secondly Yemeni origin does not invalidate their claim to descent from the Prophet because intermarriage could easily have occurred between the time of their leaving the Yemen and their arrival in North Africa. Thirdly the majority of Marabtin bil-Baraka are descendants of Holy Men, like Fakr, who started to move eastwards in the 13th. century but either died or settled in Cyrenaica where they founded lineages which are the precursors of the present tribes. This would seem to be a fairly logical explanation and certainly more credible than Fakr's presumed arrival from the east, which is the only possible alternative. It would seem strange, if this was true, that a man whose status was assured by birth should firstly reverse the dominant religious trend by moving westwards, away from the seats of learning, secondly establish himself in Cyrenaica well away from lodges or muslim universities and finally become classed as a client through his and his families dependence upon the 'Awagir or Magharba.

Although Fakr's origin may be unclear and the Fawakher's explanation not too satisfactory I was forced, in the absence of historical documents, to accept their account of the establishment of the Fawakher on their present territory. At least this information, however suspect, gives some indication of the processes of occupation and an explanation of contemporary relationships.

Fakr, it is said, settled with his family on the south-eastern edge of land then controlled by the 'Awagir, or possibly between the territories of the 'Awagir and Magharba <sup>+</sup> (see map VII.p.99). His two brothers 'Agub and Soleiman Fetouri moved eastwards and their fate seems to be unknown. The 'Awagir, as owners of the land and water, accepted the Fawakher and, because of their 'baraka', allowed them to exploit the resources of the area allotted to them without the usual fee, or 'sadqa'. In return the Fawakher provided them with elders and sheikhs who could be called in to settle disputes between Sa'adi tribes over land, water

---

+ There has been a tendency, as I have mentioned above, for Marabtin to be settled between the territories of Sa'adi tribes where they could act as buffer groups and minimise the possibilities of land disputes.

VII. FAWAKHER TRIBAL TERRITORY

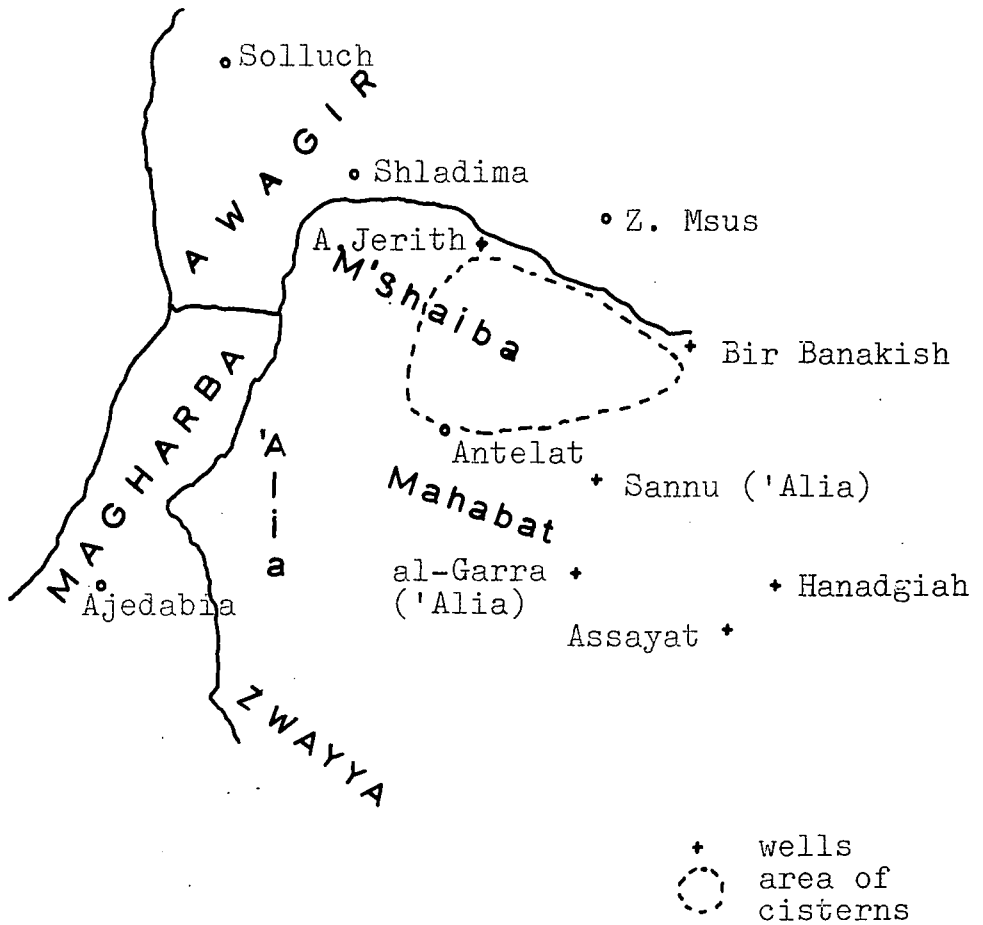

and homicides when these proved otherwise insoluble.

From the beginning the Fawakher seem to have been independent and energetic people because they did not confine themselves to settling disputes, the usual occupation of the Marabtin bil-Baraka, but took a more forceful part in the political activities of the area. Murray<sup>1</sup> has recorded that a battle between the Baraghith and Aqaqra took place at Karkura in the Barqa al-Hamra. The Fawakher together with the Magharba, 'Awagir, Jawazi, Fawayid, Zwayya and Shaheibat fought against the Bara'asa and 'Aulad 'Ali and eventually won. This also gives some indication of the Fawakher's strength because no Sa'adi tribe could coerce a dependent group into fighting for them should they not wish to do so, and so they must have had the numbers to provide a contingent and a definite incentive.

Their numbers increased rapidly because the Fawakher started to expand eastwards and to spread up the west face of the Jabal Akhdar and onto the steppe. Initially it would seem that the lack of water did not

---

1. Murray.G.W.. Sons of Ishmael. Routledge.p.289. 1935

allow them to maintain more permanent occupation of the steppe because Murray<sup>1</sup> has written that in the 18th. century a number of families migrated to Egypt where they settled as Marabtin to the Hanadi. He however also says that this was a leaderless migration but the Fawakher genealogy (see diag. 8 p.148) shows a 'son' of Fakr, Tuyoor, as having settled in Egypt which would seem to presuppose some form of leadership. In any case this Fawakher section did not remain long with the Hanadi because both groups were driven out by the 'Aulad 'Ali who had in turn been expelled by the 'Abaidat and other Harabi. This section finally settled in Sheryuiya where they ceased to pay a tribute to the Hanadi and thus became 'white' Marabtin.

In Cyrenaica the construction of new and the renovation of old cisterns finally allowed the Fawakher to establish themselves on the steppe and relieved them of complete dependence on the water supplies at Solluch which were controlled by the 'Awagir. As more land became available to them and as their flocks and herds increased the Fawakher were able to control an increasingly large

---

1. op. cit. p. 292-293

area and exercise a greater degree of independence. This was not achieved without a struggle and a state of more or less permanent conflict existed between the Fawakher and 'Awagir. Although the Fawakher were and are inferior, in terms of numbers, to the 'Awagir, their more nomadic existence bred a fierce independence and hardiness<sup>+</sup> which was difficult to overcome and the 'Awagir were forced to accept both their existence and expansion.

In 1858 the Ottoman government promulgated a land code<sup>1</sup> which finally fixed the tribal boundaries and the Fawakher came legally into existence as a tribe with a definite, defined territory. This promulgation has continued to be valid to the present day because the Fawakher were unaffected by the Italian land laws as their territory was entirely unsuitable for cultivation or settlement. Today the Watan al-Fawakher, or tribal territory of the Fawakher, runs in the west,

---

+ 'A tribe ill-disposed towards authority'. 'Too powerful and warlike to accept overlordship'. Evans-Pritchard. E.E. The Sanusi of Cyrenaica. pp.53 and 86. Oxford 1949

1. See op. cit. p. 221



south from Shladima to the northern boundary of the Zwayya, thus bordering on the territories of the 'Awagir and Magharba, and eastwards into the Sahara as far as Hanadgiah (see map VII.p. 99). However at the moment, 1967, the 'Awagir and Fawakher again dispute the ownership of a piece of land on their common border, south-east of Solluch.

## 8 The Fawakher and the Government

Relationships between the Fawakher and the Sa'adi have been, and are, characterised by disputes and periods of mutual indifference and similarly relationships between the Fawakher and the government, or external authority, have never been good with the possible exception of the period of Turkish administration when control was light and tenuous. During the Italian colonial administration the Fawakher seem to have been divided between those who actively fought against the Italians and those who had so little to do with them that their government went by almost unnoticed for it was largely with the Sa'adi that the Italians had the most trouble. The land which the Fawakher occupied was also not a part of the colonization and settlement scheme because it was unsuited to Italian needs.

Although the Fawakher were in principle in agreement with the aims of the Sanusi - that the Bedouin should become more involved with their faith - the method by which this was achieved at least in part - the extension of the belief in the efficacy of the 'saints' to include the Sanusi family and its followers - was unacceptable to them. They therefore were the only tribe

in Cyrenaica which rejected the Grand Sanusi's teachings and thus ensured for themselves continued difficulties. They did however obey the order of Muhammed Idris as-Sanusi to rise up against the Italians and Germans and to support the British forces in what proved to be their final conquest of Cyrenaica.

When Libya achieved its independence it was under the sovereignty of King Idris but the kingdom was materially so poor that the government's influence was not felt much outside the towns, and the Fawakher continued with their affairs very much as before. However with the discovery of oil, the coming of the petroleum industry, the consequent social upheaval and the growing national consciousness, the influence of the state began to spread out from the towns and into the country. As the state's wealth increased so did its activities and services and the latter began to play an ever increasing role in the affairs of the tribes. The most important influence was and is that of education. Many tribesmen were of course attracted by the benefits which could accrue from working with an oil company, but in the long term aspect education is the key to advancement in extra-tribal activities. The

government therefore encouraged the building of schools and facilities in villages which could be reached by the Bedouin. The Fawakher, however, through their earlier opposition, their pride and unwillingness to go 'begging' for aid from the government, and their isolation from villages received very little apart from the promise of grain should harvests fail and the occasional visit of a doctor. In fairness it must<sup>t</sup> be mentioned that the infrequency of the doctor's visits was not the government's fault but rather the reluctance of any doctors to take on the task of visiting Bedouin encampments.

The Fawakher were, and are, on the whole, the best educated of the tribes, not as a result of governmental efforts but because of their own desire for learning and the necessity of being able to read in order to read and learn the Koran. That this ability has not been put to use by a government and country which is in dire need of educated people could be due to two factors. Firstly opposition within the government to such a plan because many of its members are Sa'adi who would not wish a Marabtin tribe to have access to political power, or secondly and mor<sup>e</sup> probably

to the desire of the Fawakher to remain independent and to pursue a life which they prefer to that which can be offered outside tribal boundaries. For example, those visits which they make to Benghazi are, for them, not particularly enjoyable. They find the food, climate and sterility of relationships abhorrent and are only too pleased when they can return to their own tribal territory. Whatever the reasons, it is true that very few Fawakher have availed themselves of opportunities outside the tribe and this also has acted adversely for them. They now have no people of their own in positions of power or influence who could get things done for them and make government aid available if not for education then for the construction of more wells and cisterns.

Although surveys were undertaken on Fawakher land no oil was found for which at least some Fawakher were grateful because they saw in oil a potential threat to their existence as nomads and herdsmen. They have therefore remained relatively removed from its effects and seem likely to do so as long as it is not discovered near them.

So long as there is a demand for meat within Libya which can, at the moment, be best supplied by the

Bedouin then the government will not resort to some form of sedentarisation. However one can see the situation arising where extreme nationalism within the country will not allow the continued existence of the tribes because the tribesmen are considered by 'progressives' as reactionaries, as symbols of the nation's backwardness and an insult to their position or potential position in the world. The future of the Fawakher therefore remains uncertain but will no doubt ultimately depend on the attitude of the government and their own desires for the future. In the meantime the Fawakher, like all Arabs living on the margins of existence, are concerned with the present and leave the future to the will of God. They are content to pursue their pastoral and agricultural activities on the land which they have occupied with so much effort, the Watan al-Fawakher.

## 9 Physical Background

The major territorial divisions of the Watan al-Fawakher are those based on the three primary sections, the M'Shaiba, 'Alia and Mahabat, see map. VII.p.99. Within each primary section the land is further divided into secondary and tertiary section territories, in other words the principle of division is exactly the same as that practised by the Sa'adi tribes. Similarly physiographical and ecological differences distinguish and demarcate one territory from the other, at whatever level of segmentation, although of course, territorial distinctiveness is most marked at the primary section level and least marked at the level of the tertiary section.

The M'Shaiba occupy the northern part of the Fawakher tribal territory. Their land stretches up from the Barqa plain eastwards into the Sahara and southwards to Antelat.<sup>+</sup> On the Barqa plain the land is generally flat but that at the foot of the Jabal is dissected by wadis running down from the plateau and covered by

---

+ I was not in a position to map the limits of section territories and therefore must leave the description to generalisations.

alluvial deposits. The scarp of the plateau itself is steep in places, bare of vegetation, and heavily eroded. Once on the undulating, plateau-like, dip slope, the physiography is very similar to that of the plain except that one cannot see so far because of the undulations which are generally smoother and longer than those on the plain. There are large basin-like depressions, formed by the run-off from the wadis, which also provide the moisture for the carpet of vegetation which usually covers these hollows. Further east and south the land becomes flatter and more devoid of vegetative cover, until the Sahara itself is reached.

The relative fertility of the M'Shaiba area is due to the slightly higher rainfall, its greater reliability, and the nature of the soil cover. The soil is earth, interspersed with rock, and not sand. This together with the rainfall is responsible for the relatively heavy vegetation cover, concentrated in the depressions where it provides pasture for the livestock in winter and spring. The vegetation consists mainly of 'ajaram', 'irimith' and 'jil' which are low bushes of saltwort and glasswort eaten by the camels in winter. In spring these bushes are interspersed with other



plants and grasses, the main varieties of which are 'surrat kubsh', 'qalil', 'nabah', 'qarqaz', 'l'baina', 'riban', 'hauthilan' and 'qahwan'+ all of which provide good fodder for sheep, goats and camels. There are also two types of thistle, 'shok mirar' and 'shok sir', both of which are eaten by camels in spring although when grasses are available they will sometimes eat these in preference to the thistles. The bushes, grasses and thistles are seen over most of the M'Shaiba territory both on the plain and the plateau, decreasing of course, in quantity south-eastwards. Thorn bushes, 'sidr', are however more or less confined to the Barqa where they provide wood for camel sticks, tent poles and fencing for water holes and gardens.

The M'Shaiba territory is also distinctive because of the concentration of cisterns from Antelat and Alam Jerith in the west, to Bir Banakish in the east. They cover a triangular area of more than half the territory of the M'Shaiba. Many of these cisterns are new but as there is quite a lot of evidence of earlier, probably Berber, settlement some may in fact be renovated ones from this period. It was these cisterns which, as

---

+ I have used the local names and unfortunately do not know their English or Latin equivalents.

we have seen,, enabled the Fawakher to establish themselves more permanently on the plateau and finally to decrease their dependence on the water resources of the 'Awagir.

The 'Alia section's territory stretches in the west from the Magharba boundary to the area occupied by the Mahabat, and southwards to that possessed by the Zwayya. Here only remnants of the scarp remain and the area is one large undulating plain mainly consisting of sand interspersed with areas of soil which means that the vegetation is sparse, although in content similar to that recorded for the M'Shaiba. The lower rainfall, the sparseness of the vegetation and the sand have meant that the 'Alia place greater emphasis on the camel than they do on sheep and goats.<sup>+</sup> The lack of cisterns and the distance to wells - they have at least two in M'Shaiba and Mahabat territory, at al-Garra and Sannu, see map VII. p.99 - has also played a part because of the camel's ability to travel further and to go for longer periods without water.

The Mahabat occupy the remaining third of Fawakher territory with the 'Alia to the west, the

---

+ I have no statistics to support this just information from members of the 'Alia section about the general dominance of the camel.

M'Shaiba to the north, the Zwayya to the south and the Sahara to the east and south-east. The vegetation is much like that of the M'Shaiba and 'Alia and occupies the bottoms of wadis descending the dip slope of the Jabal Akhdar. It is however extremely sparse because of the greater percentage of true desert within this section's borders. The Mahabat are the most nomadic of the Fawakher because of their almost complete dependence on camels, the paucity of vegetation and the lack of water. Although water can be obtained from underground sources giving them a greater certainty of supply than from cisterns, its high saline content makes it only suitable for camels but unpleasant for human beings. As a result of their lack of resources and more nomadic way of life the population of the Mahabat is half the size of that of the M'Shaiba and 'Alia.<sup>+</sup>

All Fawakher have a claim, irrespective of the section to which they belong, to utilise the pasture of other sections if their own has been affected by drought. Although this attitude might seem unsound because it would lead to the more rapid exhaustion of pasture in

---

<sup>+</sup> Mahabat ca. 500 males, M'Shaiba ca. 1000 and 'Alia ca. 1000.

those territories which have an excess of grazing because of the accident of rainfall, it is based on very sound principles. Firstly the size of the groups which have to move because of drought and dessication is usually small and therefore can be accomodated without too much difficulty in other areas. Secondly the variability of the rainfall is such that no one group can guarantee to have adequate pasture every year so that that which it allows to be used by others in one year will become a debt enabling the donors to have access to another's pasture when it is itself in difficulty from drought. Thirdly free access to p<sup>s</sup>ture creates ties and relationships, furthers the cohesion of the tribe and maintains tribal strength which can be vital to offset the predatory attentions of other tribes. Sharing of pasture is therefore dictated by self-interest as much as anything and is not an altruistic act carried out irrespective of the consequences.

Water, however, is owned by those who were responsible either for clearing out and cleaning the wells or those who paid for and/or built the cisterns. Wells, but especially cisterns, because of their reliance on run-off, and not permanent underground seeps or springs, are kept padlocked. This is to stop people and herds from

using them secretly because their existence is indicated by the mounds of earth which surround their mouths and makes them readily distinguishable from the undulating plains. However both wells and cisterns can be used by men and their mounts when they are travelling through the area because there are apertures in the concrete covers which allow the entry of a small can attached to a piece of rope. Travellers can drink therefore when they wish and do not have to ask the permission of the owner to do so..

If, as quite often happens, rain falls sporadically and unevenly so that in some areas wells and cisterns are full and in others empty then the flocks and herds in these drought areas will move to those more beneficially favoured. When this occurs and there is sufficient water both for the 'owners' and the newcomers it is made available for a payment the amount of which is usually reckoned on the number and kind of animals to be watered.. This is not only true for the Fawakher primary sections but also for neighbouring tribes because no one knows when they themselves may have to rescue their flocks and herds by movement into other tribal territories.. Small groups of M'Shaiba, for example,

have moved in times of drought into the territories of the 'Abid and Bara'asa where they could be assured of water from wells with permanent underground supplies.. It is usually only the herdsmen and livestock which go and their families and old men remain behind because there is nearly always sufficient for the members of a tertiary section when they are relieved of the demands of their stock. Thus all groups and tribes, unless there is a long and protracted period of drought, can minimise losses in stock and increase their economic viability by the various possibilities of access to pasture and water throughout the tribal areas of Cyrenaica but which is of particular importance to those groups living on the steppe such as the Fawakher.

## 10 Subsistence Activities

### a).....Pastoralism

The Bedouin of Cyrenaica are pastoralists by tradition and inclination and cultivators by necessity, and the Fawakher are no exception to this general rule. Cultivation makes them more self-sufficient but it is so subject to fluctuation that it is never dependable. Animals, however, whatever the climatic conditions always reproduce thus bringing in money which can be used for the purchase of wheat and barley. Livestock is also mobile and when conditions of drought and dessication prevail in one region the flocks and herds can be moved to another more beneficial one. As a result of the discovery of oil the government is now in a position to import grain for delivery to those areas affected by drought and the failure of crops, thus, indirectly, supporting the pastoral way of life.

Although sheep, goats and camels are equally important in the pastoral economy it is undoubtedly the camel which claims preference and which the Bedouin regard as being the epitome of so many virtues. They say that it is only the camel which enables them, the Bedou-

in, to occupy certain regions.<sup>+</sup> The camel possesses many properties such as endurance, hardiness and a certain air of nobility to which a nomad aspires and therefore plays a far more significant role for them than sheep or goats could ever do. It is with this in mind that I would like first to turn to camel-herding and then to the grazing of sheep and goats.

The camels' cycle of movement varies with the season and the nature of the territory in which they are kept. In the winter they move over large distance<sup>s</sup>, though usually in a definite area with a recognised centre because this is the time of the most plentiful rainfall. They feed on the glasswort or saltwort in the wadi bottoms during the early part of winter and then move out into the Sahara for the pasturage which has appeared as a result of the rain. They are not dependent on permanent sources of water because the moisture which they extract from the vegetation is greater than at other times, and rain pools provide the rest. If they do need to be watered then it is far less frequently than in spring because the heat is also much less and this

---

<sup>+</sup> In many areas there are all three types of livestock, but over much of the Fawakher tribal area there are only camels.



results in a smaller water loss for the animals.

In the early spring they start moving back towards the encampments because those female camels, or niyag<sup>+</sup>, which have produced young are needed for their milk<sup>++</sup>. Their milk is of considerable importance especially in areas where only camels are reared. Weaning therefore begins as soon as possible and a string mesh bag is tied under the udders to prevent the young, 'hwar', from feeding. The camels during this period will only be away from the encampment for a maximum of four or five days before returning.

As the heat increases the herd gradually moves away for longer periods and finally gathers around a source of water which will last throughout the summer because the camels drink very large quantities<sup>+++</sup> and they would soon exhaust the drinking water of the encampment. It is at this stage that camels are sold, largely for meat, and there is usually a market at this main gathering point. For example, in the case

---

+ naga(s) niyag(pl)

++ A female camel will not accept a male until it is five years old and only has young every second year.

+++At the height of summer they need 30-35 litres a day or 100-150 litres every four or five days.

of the M'Shaiba this is Solluch. A female camel will be sold for approximately £ 50 and a male for anything between £ 80 and £ 100.

In early autumn the herds begin to disperse and move from the plain up onto the plateau for the 'ajaram', 'irimith' and 'jil' and then out into the desert to begin the cycle once more.

Camel-herding is recognised as the most arduous of all Bedouin occupations for a number of reasons. Firstly camels cover very large distances at relatively rapid speeds whilst grazing especially when suitable vegetation is scattered. They sleep very little making do with a series of rests some of which are taken during the day. They are difficult to keep together because individuals amongst them have a propensity to move off in search of other grazing, and often become separated from the herd. However they are never lost for no one would steal them. They are branded<sup>+</sup> so that other Bedouin who find them know to whom they belong and either

---

+ They are branded on the right cheek (haliga) from the right eye down to the lower jawbone (sanina), from above the right nostril down to the tip of the right upper lip (aqrabn) and on the right foreleg from the point where the neck joins the shoulder to the elbow like protrusion.

keep them or drive them towards the encampment of their owner. Especially before and during harvesting the camel-herder has to be most watchful because strays can damage the barley and wheat making it difficult to cut or stunt its growth through trampling it flat.

The amount of food which a camel-herder takes with him is usually small and consists of bread, flour, tea, sugar and water and in spring he will usually drink camel's milk. His provisions are loaded onto one camel and, to ensure that it does not wander when he is sleeping, he hobbles it by binding a rope around the front forelegs when it is kneeling.

For the reasons previously mentioned the camel-herder has to be young, but not too young to be irresponsible, and immensely hardy. This effectively restricts them to an age range of between sixteen and twenty-three years. If an outsider is employed for this task, and this sometimes occurs amongst the Fawakher<sup>+</sup>, then he is paid £ 100 for six months herding of ca. 40 camels. The money

---

+ There are quite a few Tripolitanians who do this because the presence of oil in Cyrenaica has meant the disappearance of the Cyrenaican shepherd and camel-herder for he prefers the higher wages and easier life on a rig.

comes from the owner or owners of the herd and is paid at the completion of the period of the herder's employment. This sum, as can readily be appreciated, is a large one for a small encampment to pay and therefore they much prefer a steady and plentiful supply of sons to the employment of an outsider. This is especially true in areas where sheep and goats are also part of the livestock.

The camel, as mentioned above, is an exploiter of areas otherwise unsuitable for other forms of livestock, it provides a means of transport for tents and supplies, reproduces the stock, gives milk and can be sold for meat or restocking. The hair is used for tents, and female camel urine in milk has allegedly medicinal qualities especially against snake and scorpion bites.

Sheep do not possess those qualities so much appreciated by the Bedouin in the camel but where they are grazed they form an essential part of the economy. The lamb however does have a special function and that is in its use as a sacrifice, as the meat for a stranger's first visit to an encampment, for a reconciliatory meal on the ending of a feud, for marriages, the birth of the first male child, and for religious festivals.

It therefore plays an important role in ceremony and ritual.

Sheep are largely confined amongst the Fawakher to the M'Shaiba and 'Alia sections where the vegetation is more luxuriant and where there is sufficient water. The problem of water is probably the most significant one because sheep cannot travel the long distances that camels can and in the height of summer must be watered every other day. As the sheep never remain more than three days away from the encampment from late winter until the summer their demands on the water have to be met from that provided immediately around the encampment thus competing with the camp members for its use. Amongst the M'Shaiba the sheep almost always drink from cisterns other than those used by the camp members and in times of extreme shortage are moved away to other areas, sometimes even outside the tribal boundaries where water is available but also has to be paid for.

During the winter they move further and are away for longer periods than at any other time, usually just with the shepherd. In this way the grazing, 'grait', around the encampment is preserved for use when the sheep

are lambing. Water is usually readily available and they do not need to drink so often.

When lambing starts in February and March they move steadily closer to the encampmentso that again, as in the case of the camels, the camp can drink the fresh milk and make liban<sup>+</sup>, samen<sup>++</sup> and butter. During this period they never move far from the tents usually describing a circular course during the day. They return at night to the encampment where they sleep and are milked in the morning by the women. Weaning is initiated as quickly as possible and to this end the flock is split up, with the milking animals and adults in one group and the lambs and kids in another<sup>+++</sup>.

The lambs and kids stay away for much longer periods and do in fact rarely come in sight of the encampment until a certain number of them are to be selected and sent for sale. This usually occurs in April when they

- 
- + liban is made with two or three day old milk from which the cream and butter has been separated. It is cool and refreshing when stored in goat skins.
  - ++ Samen is rancid butter either sweetened or left as it is, made from boiling butter and barley kernels and pouring off the residue.
  - +++The sheep and goats are always grazed together and are only split up for milking. This makes herding infinitely easier because where the goats go the sheep will follow.

are loaded into a truck and taken to Benghazi.

At the end of April the Fawakher start shearing. They do not undertake this activity until the last possible moment in order to get the maximum growth of wool by which time the sheep are really suffering considerably from the heat. They cluster together with their noses dragging along the ground in the shade of their bodies or in that of other sheep, and when there is a breeze they stand with their heads directed into it. They graze at night and rest during the day.

Shearing begins with the clearing out of one of the tents and the family taking up residence in another. Forty to fifty sheep are driven in and cluster at one end of the tent. They are dragged out, thrown to the ground, their legs held together with the ankles, whilst they are tied up and then carried to the waiting shearers. The cutting is done with iron shears starting at the tail and working in a line towards the head holding the fleece back with the left hand at the same time. When the fleece has been cut as far as the backbone they turn the sheep over and round so that it lies on the shorn fleece and then begin again. The sheep is then released and the next

taken. The fleece is gathered up, pieces of wool which have come free are placed in the middle and it is folded together and tied up for sale.<sup>+</sup>

Almost immediately after the shearing the harvesting is started and as it progresses camels, sheep and goats are brought to graze on the reaped area which provides them with plenty of fodder because the camels eat different plants and grasses than the sheep and goats. After the harvesting follows the most difficult period for the sheep because the weather is at its hottest and the fodder is very sparse and they must wait for the first rainfall for the new shoots to appear.

As with the camels shepherds are sometimes employed if there are no young men available in the encampment. Shepherds, unlike camel-herders, tend to come from the same tribe and are usually poor young men wishing to earn sufficient to be able to marry, or to reimburse losses in their livestock. Peters<sup>1</sup> has written that they sometimes leave the debt outstanding and then use this

---

+ Goats and camels are shorn as soon as the sheep are finished.

1. Peters.E.L. 'The Tied and the Free', p. 15. in Contributions to Mediterranean Sociology. ed. Perstiany. Mouton & Co 1966



as a bride price for a young girl in their employer's encampment.

The shepherds are usually in charge of anything up to 300 sheep for a six month period and receive in payment every tenth lamb to be born<sup>+</sup> plus £ 30 in wages.. Again wages have been inflated since the discovery of oil and it is increasingly difficult to obtain a shepherd..

b) Cultivation  
.....

Cultivation is confined amongst the Fawakher to those areas where there is earth, to the wadi bottoms, and where there has been sufficient rainfall. These three factors are usually combined but of course the most important single factor is the rain which is usually less than 100 mms. a year.. As soon as the rain starts falling in appreciable quantities the Fawakher start ploughing.. This usually happens at the end of October or the beginning of November.. It is a time of feverish activity because they try to plough as large an area as possible in order to reduce the risk and maximise the returns.. The possibility of a drought is further minimised

---

+ In 1967 a lamb cost on average £ 10.

by ploughing in widely scattered wadis so that should there be a crop failure through lack of rain in one area there is always the chance of success in another. Where one ploughs is usually established by tradition or usage though members of a tertiary section do have the right to plough anywhere in their section's territory but this is something rarely put into practice.

The area to be ploughed is first of all divided by single furrows delineating a section proportional to the size of the family. It is then ploughed leaving a space to mark each family's area. The ploughing is done with an iron headed wooden plough-share which disturbs the surface rather than turning it over. The plough is pulled by a camel and a donkey and the seed is sown broadcast.

The harvesting usually starts at the end of April and continues until the end of June or even later depending on the size of the crop. It is usual to get a thirty fold return on the amount sown, e.g. 100 kilos sown produces 3,000 kilos of barley or wheat. Prior to harvesting woven baskets are prepared, large canvas containers, 'hamairi', are made and sickles are repaired or new ones are bought. Constant watch is also kept on

the ripening grain and usually young men are sent to stay near the corn a couple of weeks before the harvesting to prevent stray donkeys and camels from eating and/or damaging the crop.

If the crop is some way from the tents then temporary shelters are put up for the men and sometimes, when it is a long way off, the family or families will move with their tents and all their belongings and set up camp by the barley or wheat. Each family is represented by at least one member at the harvest, where, as in some cases,, representation is by elderly men others take it upon themselves to do their harvesting as well. This is also true of the ploughing because it is extremely strenuous and an old man would not be capable of doing such work.

The barley, the major crop, is reaped either with a sickle or by hand. When harvesting by hand the barley is plucked out of the ground and then the roots are cut off with the sickle. The barley heads are placed into a woven basket and when this is full the contents are piled into the canvas bag. When the bag in turn is full it is tied up and placed over a donkey and transported to the stack which is situated on an open,, cleared space

where the threshing will be done.

Harvesting is made more difficult by the presence of large amounts of foreign matter such as glasswort and saltwort, grasses, thistles and thorns. However far from looking upon these as unnecessary the Bedouin regard them with favour for they provide fodder for the livestock, protect the soil from erosion and help to rejuvenate the soil after its temporary exhaustion from the barley. For these reasons they prefer the light wooden plough to the steel one which, they say, would destroy the natural vegetation. Time is also not an important factor and harvesting can be proceeded with in a fairly leisurely manner. The saving in time which a clean crop would bring would not be adequate compensation for the loss of fodder and the dangers of erosion.<sup>+</sup>

Threshing begins as soon as the reaping is completed. The barley is spread over the threshing area in a number of equal sized units and the threshing is done either with donkeys or horses. The donkeys are tied together with rope passed round their necks. They

---

<sup>+</sup> Although the Bedouin do not know the scientific reasons behind soil erosion they are such acute observers that the relationship between erosion and diminishing returns is immediately apparent to them.

are rotated from one circle to another gradually cutting the barley with their hooves into small pieces and breaking off the ears from the heads. Whilst the donkeys are on one heap the other is forked over to bring the uncut pieces to the surface and these are then threshed further. The horse works in exactly the same way except that in this case the middle of the circle of barley is kept clear so that a man can stand there and by allowing the horse less or more tether, whilst it circles, the barley is threshed by the hooves..

Once the barley has been cut and broken to a sufficiently small size the threshing is completed and the winnowing begins.. The threshed barley is gradually worked into a long ridge with forks so that one end of the ridge is pointing into the wind.. A fork is then placed on the ground in front of that end furthest away from the prevailing wind.. Starting at this end the chaff and barley are thrown into the air.. The grains drop almost vertically and the chaff creates a ridge of its own behind the fork.. The original ridge becomes smaller and smaller as the winnowing proceeds and eventually assumes the shape of a cone, the chaff forming an extended 'tail' from the cone. The barley grains

are sifted to eliminate as much foreign matter as possible and then measured and bagged, as is the chaff. The chaff is used for fodder and the barley is stored for later use. If climatic conditions allow, i.e. if there is a series of good years for crops, the barley which they eat is usually four or five years old. On the plain the Fawakher store the barley in mounds covered with clay whereas on the plateau they place it in underground spaces which are plastered with mud and then fired thus providing clean, dry and more or less animal proof storage.

When the harvesting has been completed the harvesters wash thoroughly and put on clean clothes. The Fawakher will not pray unless they themselves and their clothes are clean. As harvesting is relatively dirty work they do not pray during this period unless they are close to their tents and can wash and acquire clean clothing. Once the harvesting finishes they return to their tents, wash, pray and kill a lamb or sheep for a celebrational meal. The hardest work is over and visiting becomes possible again.

## 11 Religion

The validity of inserting a separate chapter on the religious life and philosophy of the Fawakher can be questioned especially as they are Sunni Maliki like all the other Bedouin in Cyrenaica.. I hope, however, to be able to show that a description of their belief and practices is important for a better understanding of the Fawakher and that it helps to explain certain elements of their society.. Also these beliefs and practices are in certain aspects different from those of the Marabtin bil-Baraka and markedly different from those of the Marabtin as-Sadqan and Sa'adi. Finally a description of their religious life however short provides a background for later assumptions concerning their Marabtin status, their independence from the Sa'adi and their tribal cohesion..

The Bedouin of Cyrenaica whether Sa'adi or Marabtin are Muslims and adherents of the Sunni Maliki School.<sup>+</sup> This school has been described by Ibn Khaldun<sup>1</sup> as being, in its earlier stages, conservative and

---

+ The Maliki School was founded by Malik Ibn Anas, d.794, and emphasised the 'living tradition', or Sunna, of Madina.

1. See Mahdi.Muhsin. Ibn Khaldun's Philosophy of History. p.29 Allen & Unwin. 1957

provincial and as trying to preserve the traditions and attitudes prevailing in the relatively isolated communities of Arabia.. It found acceptance in North Africa because of the similar social and cultural conditions which prevailed there. As a result western Islam was won to Malikism by the 9th. century.. Its position was challenged by the Kharijites but by the 13th. century it was again recognised and encouraged by the Hafsid rulers of Tunis. By this time its content had changed because of its contact with schools in Iraq, and with the more recent developments in religious thought in the East. Wider latitude was given for personal elaboration and this together with other factors, such as Berber beliefs and practices, gave rise to the North African phenomenon of worship and veneration of Saints or Holy Men and their tombs.

In Cyrenaica this later form of Malikism created a homogeneity of belief and practice but knowledge and observance of Islam varies considerably.. The Sa'di observe the major fast, Ramadhan, strictly, and would be the first to fight for their faith.. Otherwise they are notably irreligious, at least as far as the sedentary population is concerned. They hardly ever pray,,



know only the opening surra of the Koran, and do not give their children a religious education.. This however was not always the case because in the 19th. and early part of the 20th. centuries the teachings of the revivalist , missionary Sanusi movement which were aimed specifically at the Sa'adi had considerable effect. The Bedouin became more aware of their religion and participated more wholeheartedly in its activities. But the outbreak and protracted length of the Italo-Sanusi wars again brought a decrease in the observance of Islam and finally destroyed the movement.. As a result the Sa'adi, by the end of World War II, had reverted more or less completely to their original practices and outlook and no real attempt was made after the war to revive Sanusism, at least in its religious context.

The Marabtin as-Sadqan, as far as their religious outlook is concerned, can be classified generally with the Sa'adi because they strive towards the norms of behaviour of their Sa'adi patrons.. The Marabtin bil-Baraka,, and 'Ashraf on the other hand are generally religious.. They observe the five rules of Islam, are regarded as religious experts and live the sort of life expected by the Bedouin from religious people, for

example, leading good and clean lives, and helping the poor and the sick.

The Fawakher are also Sunni Maliki, but where they differ from the Sa'adi and the other Marabtin is in their acceptance of the philosophy of Abu Musul al-'Asha'ri<sup>+</sup> and their adherence to the original concept of Malikism as propounded by the founder of this school.<sup>++</sup> They believe completely in the precepts of Islam as laid down in the Koran and reject both 'ijma', 'general agreement among those of the faithful capable of holding an opinion on such matters and 'qijas', the determination of what should be done or believed by analogy with the teachings and life of the Prophet.'<sup>1</sup> They try to construct their lives on the basis of, and in accordance with the life of the Prophet as laid down in the 'hadith' or traditions. As the 'hadith' was also completed some time after the Prophet's death the Fawakher's acceptance of these traditions would seem to contradict

---

+ Abu Musul al-'Asha'ri created the philosophy of Sunni for Islam.

++ Evans-Pritchard has written that 'the only competitor of the Sanusiya among the Bedouin was the Madaniya which retains its hold on the Fawakher of the Barqa...' (p. 86 in *The Sanusi of Cyrenaica*. Oxford 1949) It could be that the section which commonly resides on the Barqa plain was Madaniya at the time of the Sanusi but no reference was made about this to me. As far as I was able to ascertain the majority of the Fawakher were never Madaniya then or today (1967)..

1.. Evans-Pritchard.E.E. *The Sanusi of Cyrenaica*. p.1 Oxford 1949

their rejection of the 'qijas'. This difficulty is overcome for them by the partial acceptance of some scholars' interpretations of the Prophet's life and the dismissal of the rest.. This power of discrimination is invested in their most learned sheikhs whose knowledge and decisions are respected by the rest of the tribe..

The Fawakher also deprecate the use of ritual, music and ecstatic demonstration because these methods, used by some Sufi sects to reach unity with God, are abhorrent to all Bedouin and distasteful to the Fawakher because their belief is generally intellectual, austere,, and ascetic.. The aim of the Fawakher is to be a good Muslim and to approach God, not through mysticism or the recitation of a religious formula, 'thikkr', but through trying to live as the Prophet did, by prayer, and through the orders of Islam..

In order to live in accordance with the life of the Prophet the Fawakher make constant reference to the 'hadith'.. As knowledge of the Koran and the hadith are so important all Fawakher are taught to read and write by the elders of the camps.. They copy out sections of the Koran and then commit them to memory.. Later, when they are old enough,, the elders assist the boys

and young men in interpreting the Holy Book and clarifying the Prophet's message. In this way the Fawakher try to mould their lives in accordance with the knowledge which they have gained and have a clearer picture of the kind of life to which they wish to aspire.. The degree of success achieved, of course, varies considerably but at least the attempt is made..

Prayer, for the Fawakher, constitutes the most important element of the five essentials of Islam..<sup>+</sup> Its routine dominates their daily life and is constant affirmation of their submission to, and dependence on the will of God. Its observance is compulsory for all those over the age of fourteen, although it would seem, from what I was able to observe, that this injunction is more strictly enforced for males than for females.. The men pray five times a day<sup>++</sup> outside their tents, often on elevated ground. When there are sufficient men in the encampment they will pray together with the

---

+ The Confession of Faith, Prayer, Alms, Ramadhan, and the Haj..

++ The five prayers are 'zuhr', "'asr', 'maghrub', 'isha', and 'subh', the times of which are indicated by reference to the sun.. Zuhr takes place when one's shadow is smallest, i.e. midday, 'asr when one's shadow is as long as oneself, and maghrub just after sunset.. Isha occurs one and a half hours after sunset, and subh, as the word suggests, just before sunrise.

sheikh or an elder leading the prayer.

Cleanliness is essential before prayer. In a desert environment it is obvious that water is often unobtainable, or is needed for drinking when travelling. This difficulty is overcome by the use of sand, instead of water, which is rubbed over the body and face in the regulation manner<sup>+</sup>. Clean clothes are also necessary and although this must place considerable strain on the water resources of a camp it is adhered to where possible. Otherwise, as for example when the men are harvesting at a long distance from their tents, they will not pray until clean clothes are available.

This involvement with prayer provides a striking contrast to the Sa'adi who rarely pray, leaving prayer, as they say, to those best qualified to do it, i.e. Holy Men and Marabtin bil-Baraka, whilst they pursue their pastoral activities. The Fawakher are also pastoralists but they nevertheless involve themselves intimately with Islam.

The orders of Islam are general rules governing relationships and shaping attitudes towards other people, either relatives, fellow tribesmen or strangers.

---

<sup>+</sup> This procedure is known as 'tea'mum'.

They constitute a code of behaviour towards which all Fawakher should aspire although obviously not all manage to achieve the sort of perfection required by the orders<sup>+</sup>.

'One is expected in any relationship with other people to treat them well and if called upon to judge others to be just and never biased. The basis of this respect and justice is honesty. One must always tell the truth and do the "right" thing when called upon to act.

'One must be gentle, humble and not set oneself above others or below them, help the poor and the weak and look after them in times of difficulty or scarcity. It is also necessary to take care of one's neighbour and be generous to orphans, widows, strangers and foreigners, for the Prophet says that there is nothing more important than to help one's brother because this is an order of God.

'One must also be liberal in all things but at the same time not wasteful for it is imperative not to neglect oneself, to keep the privacy of the family, to maintain one's own property and that of others, and to remember that property left in one's safe keeping must not be misused for it is more important than one's own.

---

+ These orders were written down for me by one of the sheikhs and I have tried to achieve as good a translation as possible.

'One is allowed to taste the good things of life such as food and clothing when this is possible, but to abstain from wine, gambling and illicit sexual relations. Finally it is obligatory to demand of people that they do what God commanded and to keep them away from that which He has forbidden'.

Unlike most religious dictates these orders are not prohibitions on thought and activity but rather positive assertions of what one must do. They require a positive response to life, not a negative one, and are largely concerned with relationships and attitudes to others.

The Fawakher as can be seen from their philosophy, beliefs and practices are highly orthodox Muslims with a strong leaning towards asceticism. In many ways their belief is indistinguishable from the most orthodox orders of Islam such as the Sanusiya and Wahabi. It would, however, be wrong to visualise the Fawakher as constituting a separate religious body like the Sanusiya because they do not possess, and have not possessed, a religious leader and have no religious organization, following or lodges. Although they have learned sheikhs who make doctrinal decisions for them these men cannot be compared

with the Ikhwan of Sufi Orders. Fawakher sheikhs are not removed by origin from the other tribesmen and do not form an élite group whose position is dependent upon the knowledge of prayer, litany and the mystical elements of an order. There is no division, as for example occurs among the Sanusiya, between the sheikhs and 'Muntusabin'<sup>+</sup>. Obviously there are certain men who are more learned than others and whilst this does not make them better Muslims it allows them to have a greater say and influence in religious matters. Also as 'ilm', intellectual and traditional knowledge, is a source of baraka and those who achieve more in this direction have greater prestige and status than those who are merely adherents. Leadership and power fields are difficult to pin down amongst all Bedouin groups and the Fawakher provide no exception. Generally speaking the source of authority and influence amongst the Fawakher rests on religious knowledge and learning and not on inheritance and wealth although these of course also play a part.

The Fawakher therefore pursue the philosophies of Malik ibn Anas and Abu Musul al-'Asha'ri as interpreted

---

<sup>+</sup> Simple adherents of an order who follow a Sayyid personally and politically.



by their elders and sheikhs and follow the orders of Islam and the life of the Prophet according to the abilities of each individual. These beliefs and practices represent, as far as they are concerned, the true path towards their goal which is the closest approximation to the original aims and ideals of Islam.

The two main consequences which result from the Fawakher's orthodoxy of belief are the rejection of the veneration of Saints and the subordination of tribal law to koranic law. As I have mentioned above the veneration and possible worship of Holy Men and their tombs characterised later Malikism. The movement, in the 13th. century, of religious men from Marocco and Algeria towards the Holy Cities of the Arabian Peninsula introduced these new ideas to the Bedouin of Cyrenaica. The learning, ability to heal the sick and baraka of these Holy Men gave them status and respect among the Bedouin communities where they settled. When they died their tombs and descendants inherited their baraka, and the latter continued to pursue their predecessors' activities. The veneration which the Sa'adi had for Saints and their tombs provided the basis for much of the Sanusi's success because the Grand Sanusi's personal appeal was much enhanced by his

saintly background. As Evans-Pritchard has written 'The Bedouin are familiar with Saints but ignorant of orders'<sup>1</sup>. Although Sanusi teachings did not uphold the worship or veneration of Saints they permitted its continuance and today it is as firmly planted in Cyrenaican tradition as before.

In rejecting the idea of personal devotion to the Grand Sanusi and his followers and thus, by extension, all Cyrenaican Saints, the Fawakher set themselves against the dominant tradition of Cyrenaica. In this they are unique for they are the only Cyrenaican tribe to do so and, as a result, were isolated from the other tribes. There were at first difficulties with the Sanusi<sup>2</sup> but these were resolved and the Fawakher accepted Sanusi leadership in other than purely religious matters.

The reason for this rejection of the veneration of Saints is that the Fawakher regard any such activities as paganism. They say that these Saints were men like other men except that they were generally learned and had a good knowledge of the Koran. This was however no cause

---

1. Evans-Pritchard. E.E. The Sanusi of Cyrenaica. p.65.  
Oxford Clarendon Press 1949

2. op. cit. p. 86

or reason to venerate them and their tombs and to do so was to blaspheme.

Closely tied up with veneration is the concept of baraka, or divine grace, which is considered to be present in certain religious people and to be inheritable. The Fawakher do not reject baraka but are proud to be considered Marabtin bil-Baraka themselves. It is only when baraka is believed to be present in the clothe<sup>s</sup> and tombs of Holy Men and is used as an attribute for healing that they object. Baraka for them is a gift from God given as the result of an individual's religious effort, such as memorizing the Koran or learning, 'ilm'.<sup>1</sup> It is not a salable or usable product and can never be regarded as an element worthy of worship or veneration. Veneration is accorded to God alone and the fate of every man physically and spiritually is in His hands. The Fawakher therefore not only oppose the Sa'adi because of their attitude towards Holy Men but also disapprove of those Marabtin bil-Baraka who are the reason for the Sa'adi's outlook and who perpetuate its continuance through their own behaviour.

---

1. 'Suche Wissen von der Wiege bis zum Grabe', hatte er gesagt, denn wer nach Wissen strebt, betet Gott an'. in: Hunke, Sigrid: Allahs Sonne über dem Abendland. p. 188. Fischer Bücherei. Frankfurt a/M und Hamburg 1965.

The second major consequence of the Fawakher's strictly orthodox outlook is the subordination of tribal law to religious law. The Koran is not only a Holy Book but also a social document and prescribes social attitudes and relationships and regulates social life in general to a greater extent than other religious books. Amongst the Fawakher koranic law always takes precedence over tribal law and custom where these may be opposed. The Sa'adi, on the other hand, are dominated by tribal law, not because they disrespect koranic law but because in the majority of cases they have little or no knowledge of what it involves. The Fawakher, because of their education and intimacy with the Koran, are completely aware of the extent of koranic precepts and rules and fully implement them. As a result certain aspects of their social structure, such as marriage, inheritance and blood money payments, are very different from those of any other Cyrenaican tribe. - I do not wish to explore these differences in greater detail here because they will be discussed later in the chapters on the genealogy, sections and kinship. It is, I hope, sufficient to say that the Fawakher's orthodoxy, their knowledge of the Koran and the interwoven nature of the religious and social systems make them distinct from other Bedouin tribes in Cyrenaica, but especially from the Sa'adi.

## II Organization and Relationships

### 12 Genealogy and Sections

The Fawakher number about 5,000, a rough approximation reached, by doubling the number of males. This represents a population increase of 1,700 from the figure compiled by de Agostini in 1922<sup>1</sup>. The tribe is divided into three primary sections, see diag.8, p.148, nine secondary sections and between thirty and forty tertiary sections. The basis for this division is the Fawakher genealogy which covers ten generations from the living representatives, i. e. those men of about twenty years of age, to the founding ancestor. The eponymous ancestor, Fakr, is shown as having three sons, Tuyoor whose descendants are now in Egypt, Buhema, the founder of a small section in the Fezzan, and Bumaun, the ancestor of the Fawakher of the Barqa. Bumaun in turn had two sons, one of whom, Muhammed Bumbaraka, married twice and these wives gave their names to two of the primary sections and their sons gave their names to six of the nine secondary sections. It is not unusual among Cyrenaican tribes for women to be counted as ancestresses because the well known

---

1. See Agostini. E. de. La popolazioni della Cirenaica. Bengasi. 1922-23..

## 8. FAWAKHER

## GENEALOGY

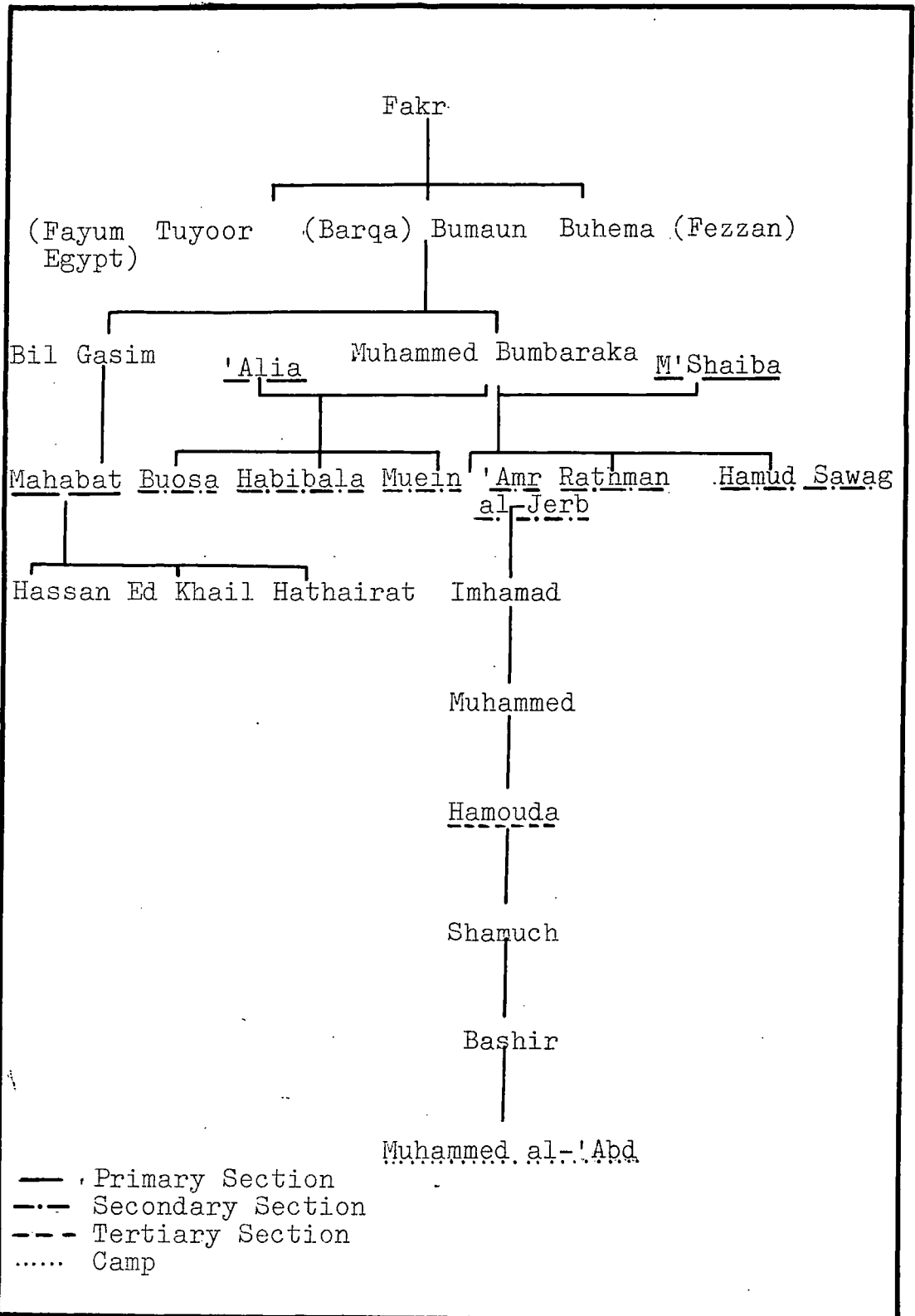

opposition between co-wives would not have allowed their sons to have been represented as full-brothers on the genealogy. At the same time this division is the perfect way of indicating the distinction, and of illustrating the closeness of the relationships among all the sons and their descendants. Bumaun's other son, Bil Gasim, is not the head of a primary section, why I am not sure, but his son Mahabat is represented as such, and his three sons are the founders of the other three secondary sections. The gap between the secondary and tertiary section ancestors is usually from three to four generations and from the tertiary section head to the living members between four and five, generational distances which are the average for all Sa'adi tribes.

The Fawakher genealogy with minor alterations, such as an increase in the number of total generations, and with the substitution of other names, is more or less identical to that of a Sa'adi tribe. This is not unusual in itself because at least two other Marabtin tribes, the Zwayya and the Qitarna, as Peters has indicated, ' form tribes which are segmented into sections on the pattern of noble tribes, and the internal relations of the sections

are also akin to those of the noble tribes'<sup>1</sup>. However both these tribes acknowledge that they are clients, that their sections are attached to noble tribes and that the Sa'adi to whom they are tied could demand their land from them should they so wish<sup>2</sup>. The Fawakher would reject the idea that they are clients in any sense, none of their sections are tied to any noble tribe and their land is inalienable and further protected by force and the Turkish land act<sup>+</sup>.

The Fawakher genealogy is also unusual in its complexity and in the fact that all its members are able to place themselves and their relationships to other members by a thorough and accurate knowledge of their genealogy. Whilst the Sa'adi themselves are 'expert genealogists'<sup>3</sup>. all the other Marabtin with the possible exceptions of the Zwayya and Qitarna have no common ancestor, are incapable of giving the names of the various sections

- 
1. Peters.E.L. 'The Tied and the Free'.p.4. in: Contributions to Mediterranean Sociology.ed. Peristiany. Paris 1966
  2. Ibid. p.4
  - + These assumptions will be explained in greater detail later.
  3. Peters.E.L. The proliferation of segments in the lineage of the Bedouin of Cyrenaica. p.40. J.R.A.I. vol. 90. 1960



of their tribes and have genealogies of only a few generations depth<sup>1</sup>..

If this is the case then some explanation is needed as to why the Fawakher, unlike other Marabtin tribes, have such a genealogy and give it such importance. The main reason is that it provides the basis for the ownership of land, water and pasture within the tribal boundaries. I have already indicated above (page 109) that the three major territorial divisions within Fawakher territory correspond to the three primary sections of the tribe. Similarly each of these sections' territories is divided into secondary and tertiary section territories on the basis of the divisions shown on the genealogy. These smaller territories are not so well demarcated in geographical and ecological terms as the major divisions but nevertheless they do exist and can be indicated by the members of the various sections. The tertiary section territory boundaries are the least recognisable, that is for the outsider, but their extent is well known and forcibly upheld by the members of the tertiary section. Within the tertiary section territory itself there are no

---

1. See Peters.E.L. 'The Marabtin and the Laff' in: The Sociology of the Bedouin of Cyrenaica. D.phil.Thesis. Lincoln College. Oxford.pres. 1951

real divisions of pasture but wells, cisterns and ploughland are owned by individuals, traditionally used by certain people, or held corporately by the members of camp groups. It is therefore clear that, although - as I have mentioned above - all Fawakher have a theoretical claim to exploit the land and water resources in any part of their tribal territory, in practice exploitation is confined to territorial divisions and section membership<sup>+</sup>.

It is of course possible to use resources in other territories but this does not constitute a 'right'. Lack of rainfall can mean that pasture or water are inadequate and in order to save flocks, herds and people it is essential to move out of one's territory. When this occurs these resources are made available either in the form of a debt which later can be collected when the donor's group is in similar difficulty, on the grounds of affinal or maternal links which can be used as a sort of claim to resources, or, in the case of water, for payment. However as a general rule pasture, ploughland and water

---

+ This does not mean that the Fawakher are a type of sedentary pastoralists. The Fawakher are nomads, some sections more than others, but their wanderings take place outside their territories in the non-tribal steppe. Their section territories are home bases with specific pastures, waterholes and ploughland.

within a territory are owned and utilised by that territory's members. Membership is, in the majority of cases, achieved by birth and thus the genealogy provides the blueprint for the division of land and the method by which membership and exploitation can be recorded and justified. Since the advent of a relatively strong central government, the establishment of tribal boundaries and the cessation of raiding, tribal and sectional boundaries and membership have assumed increasing importance and the genealogy has been reinforced as the charter of ownership..

A second reason is that the genealogy provides an explanation, as far as the Bedouin are concerned, of contemporary relationships. As we have seen above in the section on the Sa'adi, territorial distance and structural distance on the genealogy are the same. Therefore those groups which are territorially proximate are also closely related either, for example, as descendants of the same ancestor or as descendants of two ancestors who are shown on the genealogy as brothers. As relationships on the smallest possible scale, i. e. the camp group, are determined by the closeness of one's agnation or cognation to other members it is fairly logical that

the Bedouin should expand this concept to cover an increasingly large number of people and groups. For example, a tribesman can be seen as standing in the middle of a small circle of kin beyond which are other concentric circles of more distant kin. These circles increase in size until they eventually include all the members of his tribe. Therefore the closest and most understandable method of assessing these relationships is through the medium of the genealogy which immediately defines the proximity or distance in agnatic terms of any other individual. In this way their field of social relationships is readily understandable and the Bedouin can explain the bases for any particular action, transaction or incident by reference to their genealogy and lineage structure. In his article on the feud Peters<sup>1</sup> has shown that this method of conceiving social reality, 'whilst apparently logical, does not represent the truth...; it is a kind of ideology which enables them (the Bedouin) without making absurd demands on their credulity, to understand their field of social relationships, and to give particular relationships their raison

---

1. Peters.E.L. Some structural aspects of the feud among the camel-herding Bedouin of Cyrenaica. p.270 Africa. vol. XXXVII no.3 July 1967

d'être.. But,,..., it would be a serious error to mistake such a folk model for sociological analysis.' Peters is here dealing with segmentation and the relationships between segmented groups. However the basis of the segmentary structure is the genealogy.. Bedouin reasoning, therefore,, may be wrong in the way that they conceive their social relationships and how in practice they are operated but as far as my assumption is concerned Peters' statement does indicate that for the Bedouin and therefore for the Fawakher the genealogy represents a model for the explanation of contemporary relationships.

Thirdly the genealogy would seem to have had considerable importance in the past because it constitutes the basis for the formation of offensive and defensive alliances.. Lineage theory and segmentation would indicate that the smallest lineage unit, the tertiary section, combines on the basis of common agnatic descent with other tertiary sections when faced by external opposition, to form a secondary section.. Similarly a number of secondary sections can combine as one primary section, and all the primary sections can coalesce to form the tribe. This sort of political cohesion would place great emphasis on a complete genealogy which would relate

every member and group to each other individual and group through descent from the founding ancestor of the tribe. In the past tribal conflict was common throughout Cyrenaica and the Fawakher, according to informants, provided no exception to this. Fighting was not only confined to the tribal level but existed within the tribe as feuding and raiding. This latter type of conflict can be understood if it is realised that sectional boundaries were not as static then as they are now. Movement within tribal boundaries was greater and losses in livestock through disease, drought and pasture shortage were common occurrences. Bringing herds and flocks back to full strength is a long and slow process. Raiding and counterraidering therefore provided a method by which losses could rapidly be recouped. Men could be and were killed in these raids, and disputes over pasture, ploughland and wells also lead to killings. As a result offensive and defensive alliances were encouraged. Whether the men involved formed groups as forecast by the lineage theory it is impossible to say, at least the Bedouin themselves regarded such conflicts as taking place on secondary and/or primary section levels and as a result the genealogy was of very practical importance. It is

probable that, for example, not all members of a secondary section would fight against all the members of another secondary section but rather that individuals and groups would remain neutral because of maternal and affinal links and economic ties to groups within the opposing secondary section.<sup>1</sup> However the importance of the genealogies would have been in their dictation and demarcation of the lines along which groups could be formed.

Today with the cessation of raiding and overt conflict as a whole the reason for political cohesion of larger groupings such as the secondary and primary sections has disappeared. The political groups which remain are the tertiary sections together with possible affinal accretions, groups based on the personal power fields of sheikhs and the tribe itself. This does not mean that the secondary and primary sections have no functions at all, or that the usefulness of an extended genealogy including these sections has disappeared. Secondary sections among the Fawakher occupy distinct geographical areas within which its members have rights

---

1. See Peters.. op.cit. p. 275.

to pasture and water although these rights are in fact expressed through the membership of tertiary sections within a particular secondary section. Disputes still occur on the secondary section level but these are settled by appeal to tribal legislation based on koranic law and judged by assemblies of sheikhs and distinguished elders. The decisions reached are binding upon both disputant parties and the Fawakher abide by these decisions rather than allowing the classical feud situation with no end and no remembered beginning to operate.

On the primary section level, as I have mentioned above, geographical integrity is most apparent because the areas which these sections occupy are normally topographically and ecologically distinct. Primary sections do not however act as units and there are no meetings or activities on this level of segmentation. However a sociological distinction is achieved by the ban on intermarriage across primary section boundaries occasioned by the laws of inheritance which the Fawakher observe. This facet of their society will be explained in greater detail below and I hope that it will be sufficient to say at the moment that the restrictions on marriage between primary sections provides one of the



best methods for delineating groups.

On a tribal level the genealogy defines membership and provides the basis for common action. Although the tribe is represented by its sheikhs when it has dealings with other tribes or the government the decisions which they come to are observed by all tribal members because it is these members who have given this power to their sheikhs. By acceptance of these decisions each individual also acknowledges his place within the tribe and his position and responsibilities to that organization based on his birth into it. Should a member not wish to abide by these decision then he may leave the tribe.

As may have been noted from the discussion so far by far the most significant group in day to day life within the tribe is the tertiary section in terms of exploitation of resources, intensity of relationships and political groupings. I would, therefore, like to expand upon this in the following chapters.

### 13. Tertiary Section

A Fawakher tertiary section, as the smallest kin group which jointly occupies and exploits a defined territory, is composed of a number of camp groups, the number varying from section to section. Usually there are between four and ten. All the male members of the tertiary section are agnatically related to each other by their considered descent from the founding ancestor of the section. This ancestor is usually separated from the living members by a distance, on the genealogy, of four to five generations. As all members are equally removed from the ancestor they are considered, at least on this basis, to have equality of membership in the corporation and thus equal rights to the resources of the tertiary section's territory. They collectively defend these resources and may, on occasion, combine to extend the boundaries of the section's territory. They exact vengeance for the murder of a member, defend a member who has committed a murder, collectively pay blood money and may be killed for the action of another.

The tertiary section is therefore, for the Fawakher, and for the Bedouin in general, the most significant social and political grouping with of course

the exception of the camp group. Whereas secondary and primary sections have significance, as I have mentioned above, for certain aspects of the society they have little corporate reality. The various camps which constitute the tertiary sections are usually gathered together within their territory at least during the winter for the ploughing, and in early summer for harvesting. Otherwise it is difficult to generalise about the movements of the camps within a tertiary section because these are dependent upon a number of factors. The most important of these is rainfall and the availability of water for the members. Should sufficient rain fall within the section's territory then the camps may well remain there to exploit the pasture. Should there be little then the camps will move either into other sections' territories where they have affinal and maternal links which allow them access to resources or, they will move out into the non-tribal steppe and semi-desert. In periods of extreme drought they would cluster round a permanent source of water as one large camp either in their own territory or in that territory where there was water.

Another important factor affecting movement is the constitution of the livestock within a tertiary

section. Sections with camels, sheep and goats, for example, will have a multitude of decisions to make owing to the different water requirements of the animals and their abilities to cover varying distances. Whereas sections with camels as the only livestock will be able to move more frequently and freely outside their territories and will only return for ploughing and harvesting. The direction of movement and the time spent in any particular area are seen as being decided by a consensus of opinion in meetings of the men of a camp group or tertiary section. In reality however sheikhs and elders decide and the younger agnates and dependents concur. As so much is dependent upon rainfall the long term decisions are made in March and April when the winter rains are at an end and the various possibilities can be assessed. For those groups in the semi-desert areas there is always the possibility of a thunderstorm and decisions will therefore be short term and restricted to smaller, more independent units. It is possible, of course, to leave flocks and herds in charge of the younger men and in this case the elders and families would remain near water sources until the animals which are in milk return. - The possibilities therefore, within a tertiary section,,

camp group and even within the family itself for movement, gathering and dispersal are almost infinite with the exception of those periods when ploughing, harvesting and lactation are in progress. At these times the tertiary section will usually be within its own territory or gathered within easy contact in the steppe.

Visiting between camps takes place throughout the year but is especially intense at those times when all the camps are within reach. Women move backwards and forwards between their natal and conjugal camps, when these are different, and this creates a constant passage and flow of news throughout the tertiary section. Thus camps and members are bound together in communal gossip. The men move less frequently from camp to camp rather reserving their visits for certain occasions. Shearing, for example, provides the opportunity for groups of young men to move from encampment to encampment helping with this arduous and boring task. In return they receive tea and often an animal is slaughtered for a ceremonial meal on completion of the shearing. Harvesting provides another occasion when individuals or small groups will help and afterwards it is normal to exchange news and comment on the crop. Camel herders and shepherds, because of

their greater mobility, make visits throughout the year and no particular reason is necessary or required although often the loss of an animal is used as an excuse for visits to particular encampments and for more protracted stays. Whatever the reasons behind the visits of both men and women they are very important for the section as a whole because bonds are kept alive and ties are strengthened by constant interaction.

These bonds and ties are the result of agnatic, cognatic and affinal links which join all the members of a tertiary section together. The principal link, at least as far as the Fawakher are concerned, is that of agnation because agnation and descent from a common ancestor largely define membership in the tertiary section. Each member receives acceptance into the group at birth when the father acknowledges the legitimacy of the child. From then on the boy has the right to utilise the resources of his section's territory and inherits on marriage and on the death of his father the livestock which is vital for the foundation of his own wealth and prestige. He also carries, when he is old enough, the responsibility of being killed for another member's action or, having to kill in revenge for the murder of a member. Vengeance

and blood money payment constitute the ultimate obligations of the tertiary section member and the activities of the group as a whole work from this point outwards..

These activities are particularly concerned with political relationships with other sections and for these purposes a strong, united and cohesive group is essential. The Fawakher achieve this firstly by agnation and the fact that about eighty percent of the agnates reside within the territory and secondly by a high proportion of endogamous marriages which make the agnates cognates also. Thus, as amongst the Sa'adi,<sup>1</sup> each member has numerous relationships with every other member and his obligations to the group as a whole are reinforced. This agnatic/cognatic grouping is of particular importance to the Fawakher because they, unlike the Sa'adi, do not have 'Marabtin' or 'Laff' accretions who can provide political support and thus their minimal lineage is also their political group.

It is true that some men will reside within a tertiary section's territory on the basis of marriage to a female member and the greater economic benefits

---

1. See Peters.E.L. Aspects of the family among the Bedouin of Cyrenaica. pp. 121-146 in: Comparative Family Systems. Nimkoff. Boston.. 1965

which can be offered but they never 'belong' in the full sense of the word. Their allegiance, irrespective of the amount of time spent outside their own group, belongs to their agnates. The percentage of marriages outside the tertiary section is small though by no means insignificant. Although I have no figures of my own Peters has reckoned that for the Sa'adi 28% of the marriages in a tertiary section were with other sections.<sup>1</sup> As the Sa'adi also marry into their client groups, which the Fawakher cannot, then the percentage of marriages with other tertiary sections amongst the Fawakher may well be higher but certainly not more than 35%. The primary purpose of these external marriages is to gain access to resources. The resources which a tertiary section has available within its own territory are only adequate under the most favourable conditions. As rainfall in Cyrenaica is very uncertain and on the steppe may fall as a heavy shower or thunderstorm proximate areas may receive vastly different amounts. The economic viability of a section can therefore be increased if connections can be made with surrounding camps and sections. These connections are best achieved through marriage and where these prove

---

1.. Peters. op.cit. p.141



to be successful they can be strengthened by further marriages over a number of generations. If this happens then contact will be more frequent and the degree of aid will extend into other spheres apart from that concerned with resources. Thus temporary access can be achieved to pasture and water in periods of drought or shortage. It is clear that a certain amount of prestige and influence will devolve upon those members who have such links but these links mainly constitute an increase in the overall viability of the tertiary section.

The Fawakher tertiary section is therefore made up of a high proportion of resident agnates who are further bound to each other by endogamy. The relationships between members are thus highly complex and interwoven, creating the highest possible degree of cohesion within the group but at the same time obliging the members to submit to the constant and incessant demands and claims of their agnates and cognates. Protracted and heated arguments and possibly conflict result from disputes over the ownership of animals, the use of water, expected help during ploughing and harvesting and unpaid inheritances or bride wealth. As it is essential for the tertiary section to be united to protect its territory from

encroachment and to hinder division or splitting every effort is made by the elders and sheikhs to bring about settlements in disputes or to punish misdemeanours before they go too far. Insulting behaviour, causing loss of dignity, breaking the peace of the tent etc. are punished by fines. The offender is expected to pay these fines himself and can expect no help from his relatives.

As can be imagined in a society where implicit obedience is expected from young men to all men of their fathers' generation and where these men are also agnates, agnatiom leads to considerable strain but this is softened by the high degree of cognation and affinity. It is also appreciated by the members that although the claims and counterclaims of agnates may be excessive they, the agnates, are the ones who will give unquestioning and wholehearted support should major difficulties arise whereas other forms of relationships such as affinity or matrilaterality are not so certain.

The major threat to the unity of a tertiary section is caused by murder within it. This creates an almost insoluble situation for its members. As their ultimate obligation to each other is to revenge the murder of a member, to be killed for a member's action,

or to pay blood money, a murder within this section creates an impasse in relationships. Blood money cannot be paid because this would be the recognition of the existence of two distinct sections within the tertiary section and would destroy its essential unity. Revenge, unless it occurs immediately after the murder, cannot be taken because it would further disturb relations making any sort of later readjustment impossible apart from weakening the group still further. This situation is solved by the murderer either fleeing to another tribe or being banished by the elders for an undetermined period of time. The punishment varies with the nature of the crime, i.e. who it is that he has killed and how and why he was killed, and with the character of the murderer. The majority of such murders are considered accidental because it is inconceivable, for the Fawakher and in fact all Bedouin, that the murder of an agnate could be premeditated. It is therefore always possible for the murderer to return to his section but usually only after a number of years of exile..

By contrast the murder of a member of another tertiary section is viewed quite differently. It does not

threaten the unity of the group but in fact acts as a test of the strength of the contemporary agnatic relationships. The murderer together with his kin and their flocks and herds withdraw into their territory where they form a tight defensive unit. In this way they can afford each other protection from the kin of the murdered man. This situation, however, cannot last long because the flocks and herds have to be constantly moved for watering and pasture and these requirements cannot always be met within the tertiary section's territory. As a result compensation in the form of blood money is usually paid after the elders from both sections have met. If the murder is considered by the elders of the murderer's section to have been intentional, which may occur, then the murderer himself must pay the full amount and can expect no help from his 'amara dam'. This is quite different from the situation amongst the Sa'adi where once blood money is agreed upon '... all adult males accept the responsibility of contributing an equal share to the blood money'<sup>1</sup>. Amongst the Fawakher this is only done when the murder is judged by the elders to have been accidental. In this case

---

1. Peters.E.L. Some structural aspects of the feud among the camel-herding Bedouin of Cyrenaica. p.263. Africa. vol. XXXVII. No.3. 1967

all the male agnates in the section who have animals would contribute and those who have none would not.

Relationships between tertiary sections vary according to the geographical distance within the secondary section's territory which separates them. All the tertiary sections will be agnatically related to each other by their common descent from the founding ancestor of the secondary section, and the ancestors of the tertiary sections may be presented on the genealogy, and are considered by the Bedouin, as full brothers. As they are equally close in this sense the degree of contact and the strength of relationships will be affected by the number and continuance of affinal and <sup>m</sup>aternal links. As external marriages are used by the Fawakher for gaining access to resources and for creating relationships these are not normally made between proximate groups because they are potential competitors for each other's land. Any increase in the size of a section necessitates expansion and this can best be satisfied in the direction of one's closest neighbour. As a result marriages tend to leapfrog over neighbouring sections. However even between adjacent groups the lack of affinal and maternal links does not mean that there are no relationships or that there is

a state of permanent or protracted conflict. Relationships exist and opposition cannot last long because the livestock's needs dictate movement across the territory of other sections, animals stray beyond the section's boundaries and members meet around permanent sources of water and in the markets. There are therefore varying degrees of intimacy between tertiary sections which can be assessed by the number of external marriages which are made between the groups.

Relationships then within the tertiary section are intimate and interwoven and essential for the existence of the group and its members. Those between tertiary sections are either affected by competition for resources but forced by the needs of extensive pastoralism to be reasonably satisfactory or are intimate due to intermarriage, frequent interaction and complementary access to resources. The tertiary section therefore forms the perfect corporate group for social, economic and political purposes. However, for a detailed study of day to day relationships and a more comprehensive view of subsistence activities it is necessary to look at the nature and structure of the camp group.

14 The Camp Group

The camp group consists of a number of tents, usually between five and fifteen. The number will vary with the adequacy of water, the availability of pasture, the number of animals owned by the group and the wealth of the camp in general and individuals in particular. The majority of the heads of the families will be related to each other agnatically and, because of the high percentage of parallel-cousin marriages<sup>1</sup> in the tertiary section, cognatically also. This agnatic/cognatic group will represent the core members of the encampment around which more distant relatives and dependents will cluster. This 'core' group will provide the sheikh and/or elders. These men are responsible for planning and organisation of such activities as herd-movement, ploughing, harvesting etc. and will also represent the camp in extra-camp activities.

The camp group members are usually associated with a particular area within the territory of the tertiary section, at least at certain times of the year, for example when milk is abundant and when ploughing and harvesting are taking place. Otherwise, as I have explained

---

1. See Peters.E.L. Aspects of the Family among the Bedouin of Cyrenaica. P. has assessed parallel-cousin marriage amongst the Sa'adi to be as high as 48 % and I see no reason why the Fawakher should be different, or at least markedly different.

above<sup>+</sup>, the campsite may be within or outside the tribal territory depending largely upon the two factors of rainfall and the make up of the livestock.

The livestock of the camp group is herded together and is not generally split up on the basis of family ownership because this would involve too many young men whose effort and energy is required for other tasks. The shepherds and camel-herders are drawn from the camp's families irrespective of the number of animals owned by the head of a family. It is usual for herdsmen, however, to come from the poorer and dependent families because they hope, in this way, to increase their own stock through the payments in animals which they will receive for their services.

Ploughing is generally done in at least two areas so that there can be some insurance against drought. The members of an encampment traditionally plough the same areas and thus they have greater rights to their utilization than do the members of other camps. The land to be ploughed is divided up into a number of family plots, the size varying with the size of the family. Ploughing,

---

+ See pp. 161-163



sowing and harvesting are done by representatives, usually young men, from the families in the camp. Where there are no young men available these tasks will be completed by the other representatives.

Wells and cisterns are owned by the families who have built them or cleared them out. The cisterns are concreted over and padlocked to prevent their unofficial use by the members of other camps for their flocks and herds. The money for building cisterns will come from the more wealthy members, but the others also have rights to their use because they have usually contributed their labour in their construction.

The camp group is therefore primarily a herding unit in which necessities of a subsistence economy can best be fulfilled, the normal activities of daily life can be met and the obligations of hospitality can be satisfied. These then are the characteristics of what I have called the camp group and are implied when I use the term.

a) ..... A Camp in Detail  
 .....

I would like now to take one camp which I know best and use it to fill in points which did not emerge in the general introduction. In this way I hope that a better understanding of the camp group will be achieved which may help in the comprehension of relationships and should provide a backcloth of actuality for the suppositions developed below.

This camp is named after the sheikh of the group, Muhammed al-'Abd, and consists of eleven tents which are clustered along one side of a long and wide wadi. (see map VIII p. 177). This wadi and the pasturage which covers it is known as Rait Hassan. At one end of the wadi is a promontory, 'Alam Thaud, a pile of stones which marks the grave of a Fakheri<sup>+</sup>. As the sheikh Muhammed al-'Abd is widely known and respected both inside and outside his tribe 'Alam Thaud and Rait Hassan provide reference points for the location of his camp.

It probably seems strange that, amongst a tribe noted for its nomadic way of life, this camp should remain long enough in one place for its location to be fixed. The reason for this is the importance of its sheikh.

---

+ Fakheri (s), Fawakher (pl.).

VIII. The Camp of Muhammed al-'Abd

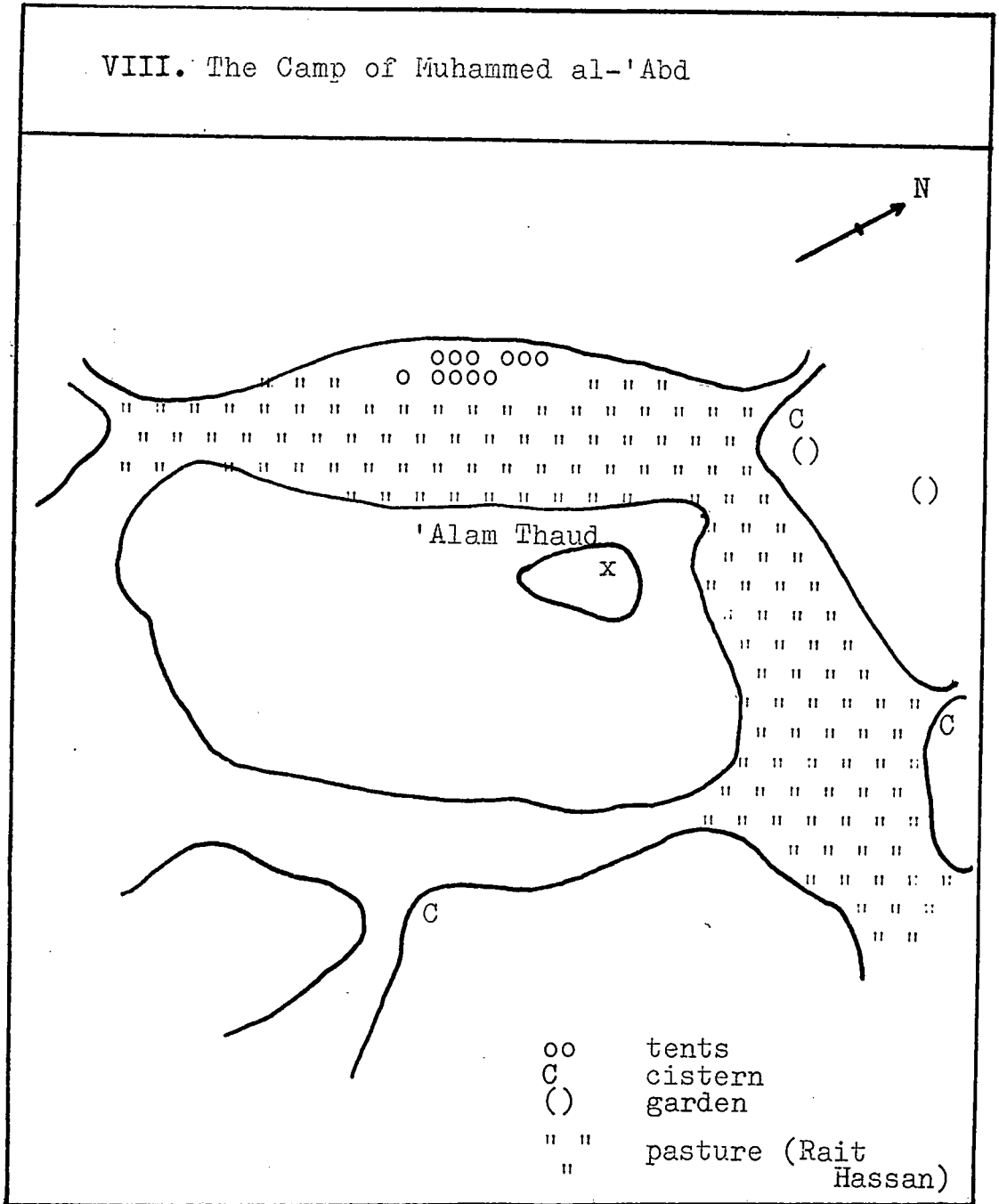

His advice and help are frequently needed by members of the tribe and his camp would be a rallying point for his tertiary section. He may also be called away for consultation with representatives of the central government who require his location to be known so that<sup>t</sup> they can contact him easily. Necessity therefore obliges him and his camp to be more static than is usual amongst the Fawakher. This is made possible by the existence of four cisterns which belong to the camp and which are within easy reach<sup>+</sup>. These cisterns are owned by the sheikh and his two brothers but are used by all the members of the camp. They provide the camp with sufficient water all the year round and can also cope with the needs of the livestock in spring when they need to be near the camp for milking. If water is scarce then the livestock and herdsmen will move away from the camp, and as human needs are very small in comparison with those of the animals, this measure will usually be sufficient to allow the camp to remain where it is. In times of drought, however, the camp is forced to move to sources of permanent water either in Solluch or 'Antelat.

The camp group is formed around an 'agnatic core' consisting of three brothers, taking one brother

---

+ Only three are shown on the sketch map, the fourth is to the north-east of the camp.

as 'ego' (see diag. 9 p.180), together with one father's brother's son and two father's father's brother's son's sons. These constitute the family heads of six tents, the heads of the other five tents being married sons of these men. There are also five sons who belong, at least by age, to this agnatic group but were then, 1967, too young to marry. Around this core are fitted the wives and young children which together form the population of the encampment<sup>+</sup>.

The spatial distribution of the tents (see diag. 10 p.181) reflects the varying degrees of proximity of the members on the genealogy. The position of the three brothers Muhammed al-'Abd (B), Salim (I) and 'Ataraif (K) is secure because, as in most Bedouin groups, power concentrates around groups of brothers and they all have sons who can support them. They therefore do not find it necessary to express their cohesion by having the ropes of their tents crossed <sup>++</sup> but form two separate units. Salim's (I) son is still young and he, Salim,

---

+ Unfortunately I was not in a position to assess affinal and cognatic relations between the members because of the Fawakher's reluctance to talk about women other than in very general terms.

++ The ropes of a tent are considered to be 'haram' and therefore by crossing ropes the closeness of a relationship is expressed and the sanctuary and protection connected with a tent covers those tents to which it is tied.

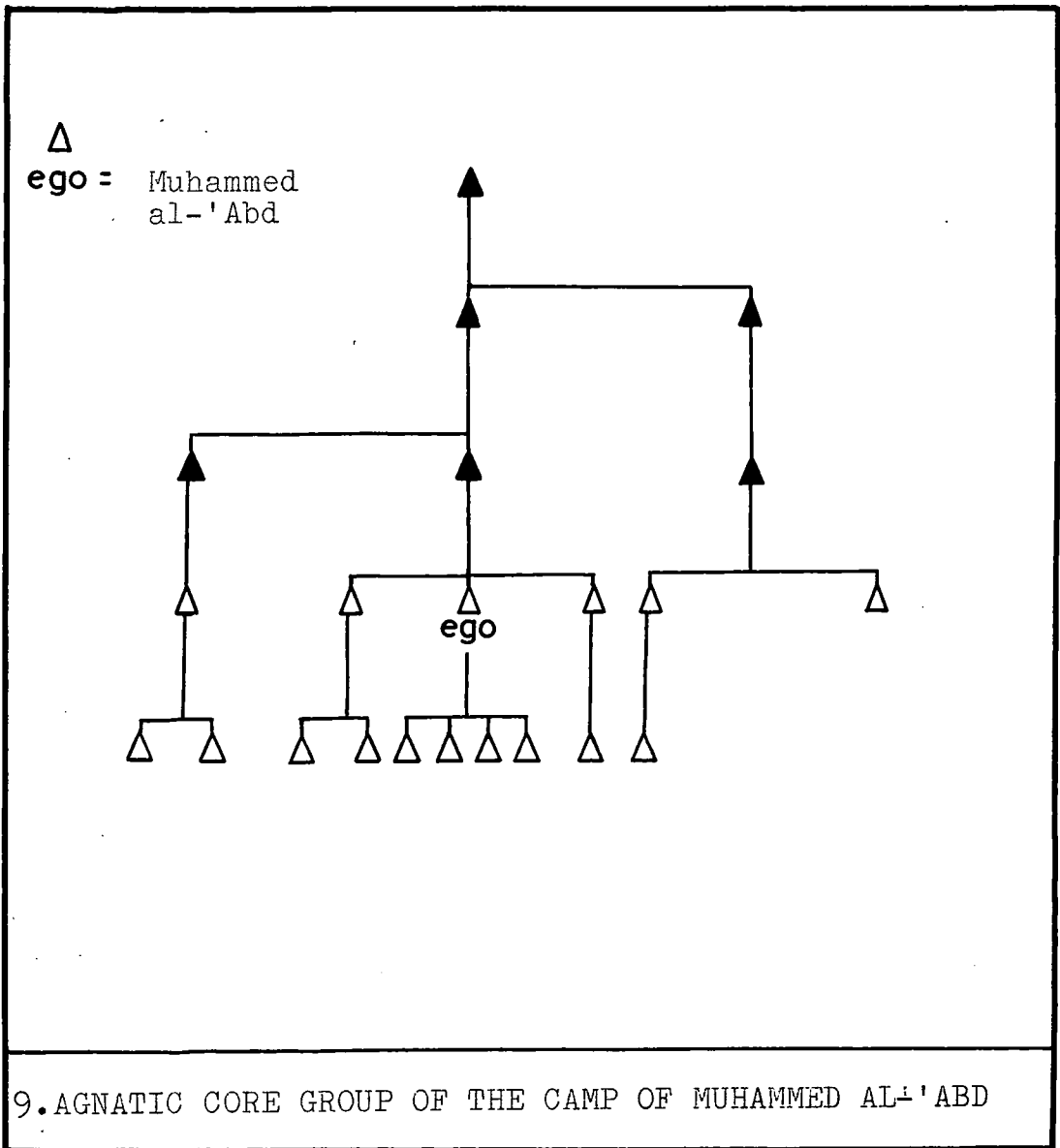



is therefore drawn into the group of tents formed by 'Ataraif (K) and his two sons (H & J). The sheikh (B) is flanked by his two sons (A & C). He has two other sons, one of whom will marry in the next one or two years and his tent will then join that of his father. Muhammed Fetouri (D), Brahim (E), Shamuch (F) and Hassan (G) on the other hand are genealogically and spatially separated from the three brothers. The tents (D), (E) and (F) belong to two brothers and the son of one of them which explains the basis for this unit. They are economically dependent on the sheikh having insufficient animals for subsistence. As second cousins of the brothers (B, I & K) they have a claim to residence and two of them, (D) and (E), are employed as shepherds by the sheikh. Shamuch (F) is generally considered to be too lazy to do anything and is supported by his brother, his nephew and the sheikh. Muhammed Fetouri and Brahim hope through shepherding to be able to build up their own stock. Hassan (G) is independent in terms of livestock having, by Bedouin standards, a larger than average flock of sheep and herd of camels. He has however only two young sons and is therefore dependent upon the manpower of the rest of the group.



It is clear, I think, from what I have written that there is in this encampment a group within the group. The three brothers (B, I & K) with the support of their sons are economically and politically dominant whilst Hassan, Muhammed Fetouri, Shamuch and Brahim are dependent. The strength and cohesiveness of this micro-group is based on a tradition peculiar to this camp. It has been the practice over a number of generations for one of the sons of the sheikh to be chosen, by the sheikh and his brothers, as the heir on the basis of his considered intelligence. This usually does not happen until the son has reached the age of 18-20 so that he has had a complete apprenticeship in all the subsistence activities involved with Bedouin existence. Once chosen the heir devotes the majority of his time to learning with special emphasis on the Koran, 'hadith' and history. He is thus groomed for office whilst the other sons, his brothers, turn their energy to the livestock, cultivation and planning. This system can best be illustrated by reference to the present sheikh and his brothers.

The sheikh, Muhammed al-'Abd, spends the majority of his time with the internal problems of the tribe,

with representatives of the government and with writing<sup>+</sup>. He is also responsible for the education of his heir, Bashir (C)<sup>++</sup>.

The eldest of the three brothers, 'Ataraif (K), is responsible for the sheep and goats. There are approximately 350 sheep and goats owned by the encampment of which 240 belong to the brothers. They are divided up into milking animals and the males and lambs and kids. Throughout the year they are never very far away from the camp, apart of course for periods of drought when they may be taken outside the boundaries of the section or tribe for water and pasture. During the spring the milking animals will feed on the pasture in the immediate vicinity of the camp and will return in the evenings to be milked. These animals are herded by 'Ataraif's two sons Naji (H) and Muftah (J). The rams, he-goats, lambs and kids are herded by Muhammed Fetouri (D) and Brahim (E) and hardly ever come in sight of the camp except to be sheared and taken away for sale at Solluch or Benghazi. The shearing of these animals is supervised by 'Ataraif and he later goes to one of the market towns with the fleeces in order to sell them.

---

+ He has written essays on religion and history.

++Bashir spent two years at the Islamic School in Al-Baidha. Since his return the sheikh has continued his education with detailed explanations of passages of the Koran and 'hadith'.

The youngest brother Salim (I) supervises the herding and movement of the 120 camels. This is probably the most complicated and demanding of the tasks involved with the livestock because the animals are away for long periods, often months, especially in winter. A great deal depends on the herdsmen because they have to be extremely hardy to keep up with the camels and have constantly to make decisions about pasture. As a result winter herding is the responsibility of Rashid (A) and 'Artija, two sons of the sheikh, who are in their early twenties. Once the camels return to the encampment in spring those animals which have young are needed for their milk and are therefore pastured within one or two days' distance from the camp. Herding then devolves on the younger boys in their early or late teens. The sheikh's youngest son, Hamouda, Salim's son 'Ateeg and Hassan's (G) son 'Ali take it in turns to look after the animals. In early summer the camels are beginning to place a strain on the water resources of the camp and so they are moved, after shearing, in the direction of Solluch or 'Amtelat where they can drink from the permanent wells in these market villages. Hassan's (G) camels (16) are not taken to Sol-

luch but herded by his son 'Ali on the steppe when there has been sufficient rainfall. They are later added to the main herd when these animals, in late summer, are to be moved away from the wells. The older herdsman Rashid and 'Artija remain with the camels and then with the first winter rains move up into the steppe and into the semi-desert.

Ploughing, sowing and harvesting is directed by all the elders in consultation. The areas to be ploughed are divided up into lots equivalent to the needs of each family<sup>+</sup>. The representatives of these families plough separately. Only where a family, such as Shamuch's (F), has no sons the ploughing and sowing are done for it. Harvesting is also left to the young men from each family where this is possible. Muhammed Fetouri (D), for example, has only one hand and his lot was reaped by his son Brahim (E). However as he, Muhammed Fetouri, was then alone responsible for herding the rams, kids and goats and could expect no help from Brahim, Naji (H) finally completed the harvesting for him so that Brahim could be freed for herding. Winnowing is done separately and the resulting

---

+ However the brothers and their sons hold one lot in common.

grain is normally sufficient for each family. The grain for the three brothers and their sons was winnowed together but then divided up between the heads of the families.

This system of divided responsibility seems to work well, Salim and 'Ataraif accept the situation without demur and have no wish or desire to alter it. Also in the case of Bashir (C) his brothers are willing to divide the responsibilities of subsistence among themselves so that Bashir can continue his educational pursuits. Their attitude is determined by tradition but also comes from the respect engendered by an educated man amongst a tribe which as a whole places a premium on knowledge.

Practical affairs are by no means neglected as can be seen by the relative prosperity of the group. The numbers of animals to members is high, and through hard work they were able to save sufficient money to buy materials for the building of two cisterns and to pay for the labour involved. Also in order to improve their diet they built two gardens dependent for water on run-off in which they could grow tomatoes and pumpkins, all indicating practical natures allied with intelligence and hard work.

Apart really from the prominence of the sheikh

and the method by which he achieves his position in the camp this group is not so very different from any other Fawakher encampment. Naturally there will be differences in the relative wealth of the groups but this is a factor of less importance amongst the Fawakher than amongst the Sa'adi because respect and prestige emanate from religious knowledge rather than from wealth and secular power.

b) ..... Male/Female Relationships

Probably the most striking feature for the outsider when living in a Fawakher encampment are the relationships between the men and the women. Contrary to the Bedouin habit and tradition the women amongst the Fawakher are kept separated from the men. They do not wear veils as the town women do but avoid the men of the camp to an extent which would at first seem impossible within such a small group. The basis for this is the Koranic stricture which allows women only to come into contact with men whose relationship to them is that of brother, father, husband and son<sup>1</sup>. All others are excluded and this is rigidly observed amongst the Fawakher.

---

1. See Surra Nisa.pp. 75-101. chapt.4. Koran in English: Abu'l-Fazi. Bombay Reform Society 1955

This 'avoidance rule' operates in such a way that should a group of women be approaching a single man or a group of men then they will walk aside so that a distance of some 50-60 yards separates them at the point of normal contact. This is the case even when one or more of the women may be related in such a way that avoidance would be unnecessary.

Men and women are therefore never seen together but remain in sexually distinct groups. The only time that this breaks down is when the husband crosses over from the men's side of the tent at night to have intercourse with his wife and when the women are milking the sheep and goats. At this time some of the men stand in a loose circle around the animals in order to prevent them from escaping whilst the women move into the flock or herd to milk them.

Following naturally from this attitude is the strict sexual division of labour. However to state that the two are necessarily connected in all cases would be untrue for this division is practised by all Bedouin groups. Amongst the Fawakher the two are intimately related, and it would be impossible to have avoidance without division of tasks. As Emrys Peters has written<sup>1</sup>,

---

1. E.L. Peters: Aspects of the Family among the Bedouin of Cyrenaica. p.137. Comparative Family Systems. Boston 1965

this delineation of duties is not resented by the women, rather it is upheld and defended rigorously should any male attempt to invade ground which they regard as their prerogative. For it is through these tasks that the women are able to establish their rights and to use them if necessary as a lever against the men.

The women are involved mainly with the home and all their tasks are coupled with its maintenance and functioning. The significance of the 'bait', in this case the tent, for the Bedouin is considerable because it provides shelter and sanctuary, is a place for meetings and prayer, is the indication of manhood and independence, and is the symbol of their way of life. The women therefore are trusted with something which is at the very core of the society and enhances their position through its significance for the group.

Care of the children from birth until they are a few years old is an essential task for the women and it is one that is very time consuming. Therefore the young mothers are usually helped by older women. The grandmother's help, for example, in rearing and controlling the children is invaluable. She is too old for arduous tasks but her role as a nursemaid is very important relieving the



mother at least from one of her many duties. Without this help it would be impossible for the younger women to complete, or even cope with, their other labours for the men remain aloof from this work although they sometimes hold and comfort a small son. The women are relieved of the responsibility of their children at an early age because they, the children, begin to play outside the tent making dolls, clay sheep and camels and pretending to be shepherds and camelherders. When they are only a little older they start to participate in the life of the encampment. They run errands and guard the sheep and goats whilst they are near the tents, thus taking an active part in the total life of the group.

Although the children learn to look after themselves at an early age, the women gain little from this because one pregnancy follows after the other. In spite of the early independence of the children the mother's relationship with them remains a very close one. This is especially true of the mother/son relationship because this is based on love rather than on respect and deference which characterizes the attitude of the son towards his father. There are therefore compensations for the initial difficulties and these remain throughout the mother's life.

One of the women's most constant duties is the collection of firewood. They go out usually in the early evening with adzes or hoes to dig out and cut up the small bushes which they gather into piles. When these are large enough they hoist them onto their heads and carry them back to the tents. They make the fires and use the hot coals placed in metal containers to cook the food which, when prepared, they place in the men's side of the tent<sup>+</sup>.

They are responsible for making the tents, patching them up, keeping the guys taught, sweeping them out and cleaning them. They weave the rugs and make the cushions, ensure constant ventilation through the tent and are there to prepare food for visitors.

Although they cook all the food the women are not allowed to slaughter sheep or goats, this must be done by the men, or in the absence of men, by boys. They are thus somewhat excluded from the ritual side of life, though in all probability this custom is much older than Islam.

---

<sup>+</sup> Serving is done by younger men as is tea-making when guests are there.

These tasks so far designated are similar for all Bedouin women but amongst the Fawakher there are some differences. Firstly the women only draw water when there are no men or young boys in the encampment, as for example when the men are harvesting. Otherwise it is normal amongst the Fawakher for the men to do this. Lifting the five gallon cans is admittedly strenuous work but this is done by other Bedouin women and so obviously is not beyond the strength of a woman. Secondly the women very rarely help with the harvest or act as goatherds or shepherds. If they do so then it is when the men are shorthanded or are absent. This however is explicable in terms of the rule of avoidance because the women would otherwise come into contact with men not in a permitted relationship to them.

The men are shepherds, goatherds and camel-herders, harvesters and water carriers. They are also responsible for planning particularly in terms of movement, sale of livestock, where and when to plough, sow and harvest, and when to change to the summer tent. They are the arbiters of authority, the upholders of discipline and the educators, teaching writing and reading and a knowledge of the Koran. Some of them also

specialise in certain tasks such as shoe-, shirt-, and rope-making.

Both sexes adhere rigidly to their duties and do not allow any encroachment for these tasks represent manhood or womanhood and are not to be impinged upon otherwise the basis of the relationship would be destroyed. However men cook and milk the sheep and goats when there are no women available and are not averse to collecting firewood when this is necessary.. Similarly the women become involved in men's tasks when the men are absent..

It would be erroneous to think that the women are completely subservient to the men, although the men themselves would like to believe this. Certainly the behaviour expected from women towards their fathers, husbands and brothers is dictated by the society in such a way that they have second class status. However a woman has certain rights which her husband must respect, for example the right to have children, to be treated reasonably well and to have an equal share of a man's time and his gifts should he have more than one wife.. Her rights will be supported by her father and brothers because they are responsible for her honour and because the bride wealth which they receive is paid over a long

period of time giving them, in the interim, a claim to her. A woman can also exercise some control over her husband and men in general, for example through gossip. All meetings and debates take place in the tent and at such times it is only a length of woollen cloth which separates the males from the females. The woman can therefore listen unobserved and anything a man says will be stored away and later discussed with other women. Because women move so frequently between camps favourable or detrimental gossip can spread very rapidly and a man's reputation can be made or destroyed. Similarly poetry, for which the women are well-known, can be used to influence a man's reputation. A particularly apt verse will spread throughout the tribe and, because of the Bedouin's delight in poetry, it will remain in their memories for a considerable time causing lasting discomfort or pride to the object of the verse.

It can, I think, be appreciated from the above, that male/female relationships are not completely one-sided and that the division of tasks practised by the Fawakher seems to work well. At least it is a process which has been proved by time to fit the needs of the members of

a community in a way which is satisfactory for intersexual relationships and for the furtherance of subsistence activities.

c.) ..... Family and Kinship Relations

Amongst the Fawakher there is no real concept of romantic love between young men and young women for they are never given the opportunity to meet other than as very young children. Young girls are soon removed from mixed company and confined to the tent and the company of women, and young boys, after the age of seven, are no longer permitted free access to the women's quarters. There is also quite a large difference in age between men and women when they marry so that the chances of their having played together and of forming romantic attachments, as children, is remote.

The segregation of boys and girls at an early age and the general avoidance of members of the opposite sex who do not fall within the bounds of allowed relationships also means that premarital sexual relations are almost unknown amongst the Fawakher. Young men also do not have the chance to gain sexual experience from older, mar-

ried women, as occurs among the Sa'adi<sup>1</sup>, because of the above mentioned avoidance and because the slightest hint of any such relationship could lead to the death of the man.

The stress on premarital celibacy and the exclusion of the possibility of romantic attachments free the older agnates from the obligation to consult their sons and daughters about their prospective partners and enables them to pursue their own interests through the bonds which are established by marriages. As can readily be appreciated in a small group such as the camp group the need for cohesiveness is considerable. This can best be achieved through a multiplicity of ties being created among the members and for this purpose parallel-cousin marriage is ideally suited: '.... it creates a complexity of linkages which almost amount to confusion, thereby maximising the choice available to individuals to meet whatever contingencies befall them'<sup>2</sup>. Among the Fawakher, as among the Sa'adi, parallel-cousin marriage is prescribed, the brother's son having the 'right' to marry

---

1. Peters.E.L. Aspects of the Family among the Bedouin of Cyrenaica. p.129. in Comparative Family Systems. Nimkoff. Boston 1965

2. op. cit. p. 133

his father's brother's daughter. It is only when he abrogates this right that other males can come forward as suitors.

Marriages outside the camp group and tertiary section are of course also made though usually for economic reasons, the relationships thus established making an area available for water and pasturage if drought occurs in one's own. The Fawakher are however unusual or different from other Cyrenaican tribes in the sense that affinal relationships are never made outside primary sections unless under very unusual circumstances<sup>+</sup>. This is because of their adherence to the laws of inheritance as laid down in the Koran<sup>++</sup>. They accept, unlike all other Bedouin, the right of women, whether widows, sisters or daughters, to inherit property and money according to the regulations of verses 11 and 12 of Surra Nisa. This would mean if they married outside their primary section that members of other primary sections would have rights to their land, moveable property and animals. This, how-

---

+ The Italo-Sanusi war being a case in point.

++ The Koran, Surra Nisa: 7. 'Men shall have a portion of what their parents and kindred leave, and women also shall have a portion of what their parents and kindred leave, whether it be little or much: a set portion is due to them'.



ever, would be untenable for it would mean the breakdown of the integrity and unity of the group through the wide dispersal of property and the consequent weakening of the economic viability of the herding unit.

The marital range is therefore restricted to those who are structurally and therefore spatially close, i.e. within the primary section. This system has advantages and disadvantages for it means that property and land is not alienated but at the same time it increases the social distance between primary sections thus to a certain extent weakening the strength of the whole tribe when called upon for common action. It also means that if there were feuding or raiding between primary sections there would be no affinal relatives in the opposite camp who would remain neutral or attempt some sort of reconciliation. However amongst the Fawakher this is compensated for by the rarity of such hostile activity, and the willingness of the tribal members to first appeal to a council of elders well versed in koranic law to settle the dispute. At the same time when the tribe as a whole is faced by outside opposition they seem to combine effectively for defence or attack as is evidenced by their very existence.

The marriage ceremony itself is by arab standards a very minor affair. One or two men go to collect the bride and bring her to the encampment where the bridal tent has been placed apart from the rest of the tents. There is no dancing or ritual and the amount of singing is minimal just sufficient to make it obvious that a wedding is taking place. The wealth which changes hands is also minimal, not because the Fawakher are poor, for in terms of livestock to population they are amongst the most wealthy of the tribes, but because demonstration of wealth and status is looked upon as unseemly.

The bridal tent remains apart from the rest of the encampment for some days (usually seven) and then it is removed and takes up a position allotted to it with the rest of the tents. During this period of relative exclusion the son continues to demonstrate his dependence on his father by returning to his tent in the early morning and taking up his old sleeping position near his father. He continues to eat out of the same bowl as his father and the new daughter-in-law assists her mother-in-law in the preparation of the food and other household activities. Even though in the eyes of the world the son has achieved the status of a married man with an indepen-

dent tent he is still a son and the relationship which existed before marriage continues hardly disturbed by the event of marriage.

However if one relationship, that of father/son, remains much as before, other relationships have been altered. In the case of a parallel-cousin marriage the first cousin has become a husband or wife and one's agnates become also one's cognates. Thus the multiple role relationships which are so much a part of Bedouin existence and solidarity are further extended and strengthened. But at the same time there is the potential threat to the group's solidarity created by the new unit's existence, for its growth and increase could put a strain on the balance which has been achieved with water, supplies and pasture, and any incident may be the cause of division<sup>1</sup>. This need not occur but nevertheless Bedouin in general express their fear of this occurrence through their hesitation to allow their sons to marry<sup>2</sup>. It would however be inconceivable that they should prohibit marriage because this would involve an even worse situation i.e.

---

1. See Peters op. cit. p. 125

2. See Peters op. cit. p. 126

that of a man's name disappearing through having no grandsons<sup>+</sup>.

Marriage outside the camp group also creates new relationships because the wife's group becomes one's affines as does the husband's group for the wife's. This may lead to further marriages but even if it does not the two groups are drawn closer together and co-operation and claims to pasture and water facilitate interaction and the strengthening of both group's positions.

It is difficult for me to comment on husband-wife relations for I was unable, through exclusion, overtly to observe their joint activities, and I must therefore work on presumptions and information, which provided insights, given in explanation of other facets of their society. As I have explained above, the concept of romantic love does not enter into the original conception of the marriage but affection is an element which may well emerge over the process of a few years of successful co-habitation. This is extremely difficult to observe in a society where one does not mention women by name in front of other men, where men and women are rarely seen together

---

<sup>+</sup> The grandson usually takes the name of the grandfather.

and where public displays of affection would be stigmatised. However the preponderance of monogamous relationships would seem to suggest that the couples were happy with their existence and that its continuance was not only due to economic factors, habit and the successful birth of sons though undoubtedly these all play a part, but <sup>to</sup> something else also.

The norms of Fawakher society are such that the woman is expected and required to do all that she can to please and satisfy her husband. He has rights over her which include sexual intercourse, preparation and cooking of food, the keeping of the tent and the upbringing of the children. If these are all kept then the husband would have little cause for complaint but he nevertheless has the right to marry other women. It is not always the additional expense which keeps him from this action, but, I would think, habit and possibly affection which emerges and is consolidated over the years. The wife can also make her husband's existence that much more difficult should she wish to do so, and that she does not would seem to be indicative of something more than the pressure of societal norms. Whatever the reasons, probably a combination of many factors, their marriages do seem to be successful and happy.

Normally after nine months of marriage the wife bears a child which rapidly adjusts itself to the group subconsciously through observation and consciously through parental control. Young children in an encampment are loved by its members and all their wishes are attended to. This all embracing love especially from the mother is something which never loses its force in the mind of the child even though later it may have to compete for its parents' affections with other siblings. As the children grow older the relationships with the members of the encampment alter because the children enter their separate hemispheres of responsibility and activity. The boys' relationships, for example, are with the men, and particularly with their fathers. The society has created standards of behaviour which should be shown from son to father and are expected by the father from the son. This relationship is one of extreme respect on the part of the son who obeys without question the orders and directives of his father. He never expresses an opinion in the presence of his father, he is always humble if rebuked and takes his father's side unhesitatingly in disputes. He serves him and his guests during meals bringing the water and soap round for washing, placing the bowl of food before the guests and afterwards

clearing away, pouring water over the men's hands and making the tea. He is sent away for long periods with the livestock, or to work on the harvest, or sent to help close kin with the watering of the camels, shearing and harvesting.

It would appear from what I have written that the father/son relationship is completely one sided, the son giving and the father accepting. But the son does have rights of his own which he can reasonably expect to be fulfilled. The father is responsible for his circumcision and for his Koranic education, the latter being very important for the Fawakher, though generally neglected amongst the Sa'adi. The Fawakher teach their sons to read and write through the medium of the Koran. They are given slates and chalk and gather in one tent where they are taught either by the father or by one of the father's brothers. They write down sections of the Koran and memorize them, a process which continues over many years so that they are soon masters of large sections of the Holy Book. As they get older the meaning behind the words is explained to them and they are encouraged to commit larger and larger sections to memory. As a result of this education the Fawakher have become noted throughout

Cyrenaica for their literacy and knowledge both of which on a tribal scale are unique amongst the Bedouin of Cyrenaica.

The father is also responsible for his son's marriage, arranging it and providing the necessary wealth for its accomplishment. The Fawakher men are usually married at about the age of twenty-three or twenty-four and there seems as far as I was able to observe no real reluctance on the part of the fathers to arrange for their sons to marry. The latent opposition which exists amongst the 'noble' tribes between fathers and sons does not occur to the same extent amongst the Fawakher. Once the marriage has taken place the relationship does not alter or at least is not seen to alter although a fundamental change has occurred in the son's status and role. As he grows older he takes an increasingly larger part in decisions of the group and will by this time have a son or sons himself who will be repeating the process he himself went through.

The expectations of a father's brother from his brother's son are in many ways the same, that is in behaviour and respect, as that of father/son. There is considerable formality between them and a nephew will



obey his uncle as unhesitatingly as he would his father. This however alters to a certain extent when the brother's son has achieved marital status because then he is able to express his own opinion and his uncles are prepared to listen.

The father's brother, because of parallel-cousin marriage, is also a potential father-in-law and one cannot afford to alienate him. The brother's son therefore must be most circumspect supporting his uncle's decisions and never talking loudly or lewdly in his presence. However there is one hold which the brother's son has over his father's brother, that of the 'right' to his daughter. Should the uncle try to marry his daughter to someone else without first of all obtaining his nephew's permission then he, the nephew, can prevent the marriage and thus thwart his uncle's plans. In reality, however, it rarely goes as far as this for the brother's son can usually be placated by a gift of some sort or may make no objection.

The attitudes and relationships expressed here between father/son and father's brother/brother's son are illustrative of the respect engendered by generation difference and this governs all relationships between younger

men and older ones. Where there are no kinship ties an older man will be listened to and classified as belonging to the father's generation and the term of address will express this age difference. Age itself is thus also indicative of status even where no other relationships exist. However in one or possibly two instances this basic behavioural norm is inoperative. These are the sister's son/mother's brother and grandfather/grandson relationships.

The mother's brother/ sister's son relationship may be seen as a natural counterbalance to the authoritarian and disciplinarian attitudes of one's father and father's brother. It would therefore be a means whereby the pent up feelings of the son and brother's son can be released through the intimacy and indulgence of the mother's brother. There is no formality between them so that the sister's son can enjoy all the freedoms he is denied in his relationships with his father and paternal uncles. This is made explicit through an established 'joking' relationship which they engage in on meeting. However there are deeper aspects involved for the sister's son is able to use his maternal uncle as a go between and intercessor prior to marriage, to call upon him for assistance when in conflict with his father or father's brother and to have rights to water and pasture should there be difficul-

ties in connection with his own, presuming of course that the mother's brother lives in another camp at some distance from the sister's son's. He also may inherit property should the mother's brother die without issue. These are ideal relationships and may not occur in every case, for example, if a number of sister's sons compete for the services of one maternal uncle. But whatever the case this relationship does perform an essential service for the group, reducing generation hostility and providing a vital extension of relationships.

The grandfather/grandson relationship is one of unquestioned authority on the one hand, because of age and experience, and of affection on the other. The grandfather is interested in his grandson from an early age and will hold and care for him. This is not completely disinterested affection because the grandson will often be given the name of his grandfather and in this way it will be continued and not lost from the patrilineage or in men's thoughts. This relationship serves also to reduce generation hostility.

The mother/son, mother/daughter relationships are very different in the sense that there is no feeling

of or possibility for tension or discrete hostility. The mother/son relationship has already been described to a certain extent above and without more detailed information, which I could not obtain, nothing more can be added to this. Mother and daughter have greater contact than mother and son because the daughter is involved at an early stage with the affairs of the tent. Mother and daughter are on good terms with each other because of their mutual affection, the aid which the daughter can offer her mother and the education, in female tasks, which the mother gives to her daughter. Only when the daughter leaves to take up residence in another camp and becomes there an integral part of that system as a wife and mother will the ties with her mother lose their strength because her allegiance, in certain things, will have been transferred to her husband and his group<sup>+</sup>.

The daughter-in-law is initially in a difficult position, especially if she has come from a different camp, because she is subordinate to her mother-in-law. This re-

---

+ However the strength of agnatic ties is so great in Cyrenaica that a married woman is always considered as 'belonging' to her agnates. She will return to them when there is trouble with her husband or, after his death, will often settle again in her natal camp if she has no sons. Her agnates remain responsible for her conduct and also for her revenge should she be murdered.

relationship will, of course, vary according to the closeness of the kin ties but broadly speaking it is true. The mother-in-law will initially be critical in order to ensure the best possible treatment for her son from his wife. As the son/husband will continue to eat in the paternal tent then the daughter-in-law will be involved essentially with services to this tent and there she will be supervised by her mother-in-law.

Between brothers there is a very strong bond of kinship but also strong pressures against equanimity, especially if they are two sons of different mothers. Initially there are more factors bringing them together than pulling them apart, for example kinship and political bonds. But later they tend to see each other as competitors for property and livestock and possibly as obstacles to marriage especially when there are wide differences in age. The eldest brother also commands and demands respect so that friendship can be strained quite easily. As a result even a split can occur between brothers due to competition, what is judged to be bad treatment, or a struggle for leadership. This split most frequently occurs between half-brothers when conditions become such that one leaves the encampment with his supporters and

sets up a new herding and camping unit elsewhere. This is potentially a new lineage if it is economically successful and multiplies rapidly. Any break is regarded with disapprobation but the economic organization of the society demands a continual splitting of groups in order that the total system may continue. Brother/brother relationships, therefore, are ambivalent, elements pushing towards continued cohesion and other elements demanding and necessitating split.

The relationships between brother and sister are usually close although amongst the Fawakher they have separate activities and live in different sections of the tent. However there are important links keeping them together. The brother is responsible for his sister's virginity at marriage and should she not prove to be a virgin then he must avenge this insult to the family's honour. This may not seem to be particularly conducive to good relations between them but amongst the Fawakher the restrictions on the movements of members of both sexes are such that the chance of any girl having pre-marital sexual intercourse is extremely slight. Also the early age at which girls marry militates against any outside illegal attraction, or the desire for experimentation,

so that relations between brother and sister even over this matter are good.

The sister's bridewealth may also and is often the cause, or opportunity, for her brother's marriage and this ties them closely together should there not also be reciprocal affection. The marriage of a sister also means the creation of new relationships which can be of considerable importance bringing greater unity to groups and a satisfactory dependence based on the use of facilities otherwise not available. Women are thus the 'stepping stones' across group boundaries for they increase the chances of survival in a harsh environment and are insurance against natural disaster.

It is probably amongst cousins that real friendship exists for here there is no competition and no structural demands which would lead to potential hostility. They are united as young men in opposition to the older generation and are potential brothers-in-law. Their activities bring them together except where there is tension between brothers such that they compete for their cousins' support but generally this is the most uncomplicated and independent, in the sense of strictures governing behavi-

our, of all relationships within a Bedouin group.

The importance of kinship relations within and extending outside a Bedouin encampment cannot be over emphasized. They are the very fibre of the organization placing each person within a framework and ordering his relations, attitudes and expectations with those around him. They govern his interaction, dictate the roles he plays with various individuals and determine to a certain extent his status. They unite him with others against the outgroup and contribute towards an ever increasing network of relationships which allow him freedom but also move, when necessary, in the direction of restraint. In these ways the Bedouin group differs from the non-kinship group because as soon as one is born bonds of kinship come into existence and to some extent remain so independently of the character, intelligence or drive of the individual. However the Fakheri must not be seen as some sort of an automaton controlled by the dictates of his kinship system. Certain relationships are established at birth but others are created through affinity over which he has some control. Generally he can either damage relationships so that they are invalidated or help them so



that their potential strength becomes actual.

Whatever the outcome it is generally true that the corporation's control of the member is facilitated by kinship and cohesion is achieved, with of course the qualification that division can occur.

## III

15 Conclusion

It is probably clear from what I have written about the Fawakher that there are many gaps in my analysis. These gaps resulted from the amount of time I spent with the Fawakher and from my rather inadequate knowledge of Arabic. My task was also made more difficult by the reluctance of the Fawakher to talk about women in anything other than very general terms. As a result the detailed information about affinal and maternal links between agnates, so necessary for a balanced study, is completely lacking. Although I feel that this does not invalidate my work it places greater emphasis on agnation than, in reality, exists and leaves areas open to question which I am in no real position to answer. I have tried to make the best possible use of the rather haphazard information which I collected and to combine this with assumptions based on evidence available from the works of Evans-Pritchard and Emrys Peters<sup>+</sup>.

Irrespective of the difficulties and the incomplete information, a number of points emerge from the

---

+ It is not, I think, too unreasonable to assume that a tribe existing in the same environment, engaging in the same subsistence activities and having the same language and cultural background should solve its problems and organize itself generally in a similar manner to those tribes which surround it.

study. Firstly the Fawakher own the land on which they live and utilise its resources. Their claim to ownership rests on their occupation of the territory, their ability to defend it against outside encroachment and the Ottoman Land Code of 1858. Secondly they have a founding ancestor and an extended genealogy which binds all the Fawakher together. The genealogy is also the charter for landownership. Thirdly they have an orthodoxy of belief which distinguishes them from other Cyrenaican Bedouin. This belief affects marriage, inheritance and the settlement of disputes because they observe koranic rather than tribal law in these matters. Finally they are an independent tribe owing allegiance to no other tribe and none<sup>e</sup> of their sections, as far as I was able to ascertain, are attached to Sa'adi sections or tribes.

The question that then arises from the material which I have presented is: How and where do the Fawakher fit into the total tribal society of Cyrenaica? Peters has shown in his article 'The Tied and the Free' that there is a greater degree of social mobility among the Bedouin of Cyrenaica than one would at first think.

This is not a one way movement from Patron to Client but, also, involves movement upwards: 'Many groups which are acknowledged to be of client origin function as groups of free men'<sup>1</sup>. The basis for this upward mobility is the ownership of land: 'If, . . . ., a group of people come to own a strip of land by conquest or any other means they necessarily appear as a group on the genealogy as descendants of Sa'ada'<sup>2</sup>. If this is possible the question could be asked as to why the Fawakher, who own their own land, have managerial control over its resources and have a tribal genealogy, have not become Sa'adi also?

The reasons would seem to be the following. Firstly the Fawakher are proud of their status as Marabtin bil-Baraka because of their orthodoxy of belief and their koranic education. Secondly they would not achieve an increase in status, at least among the tribes, through the acquisition of Sa'adi status although this would possibly give them access to power in the central government. Thirdly they would lose, by attachment to the Sa'adi genealogy, their considered descent from the Prophet and this, as

---

1. Peters.E.L. 'The Tied and the Free'. p.13 in: Contributions to Mediterranean Sociology.ed. Peristiany.Paris 1966

2. op. cit. p.12

far as they are concerned, would far outweigh any benefits which might accrue from Sa'adi status. Finally they could not be regarded as Sa'adi because they do not have clients, although of course were they to achieve Sa'adi status their control of resources would enable them to support clients.

They also cannot be classed as Marabtin (clients) because their land and its resources are their own and they are not politically dependent on the Sa'adi<sup>+</sup>. They are, however, Marabtin bil-Baraka for the reasons I have mentioned above and also because of their religious observance, the authority invested in their sheikhs and the status which they have vis-a-vis the Sa'adi. Nevertheless their relationships with the Sa'adi are very different from those of the Sa'adi with other Marabtin bil-Baraka. These Marabtin constitute small groups living within the boundaries of Sa'adi tribes from whom they receive land and resources in return for the services which they offer.

---

+ The Marabtin Zwayya, for example, also own their own land and are powerful enough to defend it against Sa'adi encroachment but each of the four sections into which they are divided is politically attached to a Magharba section. See: Peters.E.L. 'The Marabtin and the Laff'. in: The Sociology of the Bedouin of Cyrenaica. D.Phil. Thesis. Oxford 1951

The Fawakher must also, when they first settled in Cyrenaica, have formed a small group on the outskirts of 'Awagir or Magharba tribal territory and may well have offered their services in return. Their present relationships, however, are very different because the Fawakher are independent territorially and politically and are not obliged, in any way, to comply with the wishes of the Sa'adi.

The Fawakher therefore do not belong either to the preponderant patron/client system of relationships or to the Sa'adi/Marabtin bil-Baraka system as it has been described by others. As we have seen, relationships between the Sa'adi and the Marabtin as-Sadqan vary according to the size and degree of independence of the Marabtin group. It would seem to me that the only possible way of fitting the Fawakher into the total tribal society of Cyrenaica would be to regard them as a part of a similar range of relationships existing between the Sa'adi and Marabtin bil-Baraka. Thus the families and small groups so far studied would constitute one extreme and the Fawakher, as an independent tribe from my analysis, the other.

Bibliography

- Abou Zeid.A. Sedentarisation of the nomads of western Egypt. International Social Science Journal. vol.XI no.4 1959
- Abou Zeid.A. Honour and shame among the Bedouin of Egypt. in: Honour and Shame. ed. Peristiany. 1965
- Almoravids. Encyclopaedia of Islam. A-D Leiden. E.J.Brill & Co. London. Luzac & Co. 1913
- André.J. Histoire de L'Afrique du Nord. Payot.Paris. 1961
- Awad.M. Settlement of nomadic and semi-nomadic tribal groups in the Middle East. I.L.R. Jan. 1959
- Ayoub.M. Parallel cousin marriage and endogamy. A study in sociometry. S.W.J.A. 15 pp.266-75 1959
- Baer.G. Population and Society in the Arab East. Routledge & Kegan Paul. London. 1964
- Barth.F. Father's brother's daughter marriage in Kurdistan. S.W.J.A. vol.10 pp. 164-72 1954
- Barth.F. Models of Social Organization. R.A.I. Occasional Papers. 1966.
- Barth.F. Segmentary opposition and the theory of games: a study of Pathan organization. J.R.A.I. 89 pp.5-21 1959
- Bates.O. The Eastern Libyans. London. 1955
- Befu.H.. & Plotnicov.L. Types of corporate unilineal descent groups. A.A. 64 pp. 313-27 1962
- Burckhardt.J.L. Notes of the Bedouins and Wahabys. Colburn & Bentley. London. 1831
- Cauneille.A. Le semi-nomadisme l'ouest Libyen. Nomades et nomadisme au Sahara. Recherche sur la zone aride. XIX 1963

- Clarke.J.I. Studies of semi-nomadism in North Africa.  
Economic Geography. pp. 95+108 vol. 35 1959
- Clarke.J.I.. Summer nomadism in Tunisia. Economic Geography  
pp. 157-167 vol.31 1955
- Clarke.J.I.. Oil in Libya. Some implications. Economic  
Geography. vol. 39 1963
- Coon.C.S. Caravan. Cape. London. 1952
- Coult.A.D.. & Hammel.E.A. A corrected model for patrilat-  
eral cross-cousin marriage. S.W.J.A. pp. 287-96  
19. 1963
- Cunnison.I. Baggara Arabs.. Clarendon Press. Oxford. 1966
- Davenport.W. Non-unilinear descent and descent groups.  
A.A. 61 pp. 557-72 1959
- Dupree.L.. The non-Arabic ethnic groups of Libya.M.E.J.  
Winter. 1958
- Dupree.L.. The Arabs of modern Libya. M.W. pp.113-24.  
48. 1958
- Evans-Pritchard.E.E. The Sanusi of Cyrenaica. Oxford. 1949
- Evans-Pritchard.E.E. The Nuer. Oxford. 1940
- Fortes.M.. The structure of unilineal descent groups. A.A.  
iv. pp. 17-41. 1953
- Fried.M.H. The classification of corporate unilineal  
descent groups. J.R.A.I. 87 pp. 1-30 1957
- Gibb.H.A.R. & Bowen.H. Islamic society and the west..  
pt.1 London.. 1950 pt.2 London. 1957
- Guillaume.A. Islam. Pelican Original. 1964
- Haddud.N.E. Blood revenge among the Arabs. J.P.O.S.  
vol. 1 no.2 & 3. pp. 103-112.
- Hagopian.E.C. The status and role of the Maraboutin in  
pre-Protectorate Morocco. Ethnology. vol. 3 no.1  
pp. 42-52 1964



- Hajjaji.S.A. The New Libya. Tripoli. Libya. 1967
- Hasanein.A.M. The Lost Oases. London. 1925
- Helaissi.A. The Bedouins and tribal life in Saudia Arabia.  
I.S.S.J. vol. XI. no. 4 1959
- Hilal.Bani. Encyclopaedia of Islam. vol.III. Leiden. E.J.  
Brill. & London. Luzac & Co.
- Hitti.P.K. History of the Arabs. 6th. ed. London. 1956
- Ibn Khaldun. Histoire des Berbères. Tome Premier.  
Paris. 1925
- Ibn Khaldun. The Muqaddimah. an introduction to history.  
trans. Franz Rosenthal. Bollingen Series. XLIII.
- Idris.H.R.. La Berbérie Orientale sous les Zirides. vol.I  
chap. IV. Paris. 1962
- Jacob.G. Altarabisches Beduinenleben. Hildesheim. 1967
- Krader.L. Ecology of central Asian pastoralism. S.W.J.A.  
no.4 pp.301-325 1955
- Landau.R.. Islam and the Arabs. George Allen & Unwin. 1958
- Lane-Poole.S. The Mohammedan Dynasties.. Constable  
Westminster.
- Leach.E.R. Social and Economic Organization of the  
Rowandaz Kurds.. Monographs in social anthropology.  
L.S.E. London. 1940
- Leach.E.R. Descent,, filiation and affinity. Man. 60  
pp. 9-10 1960
- Lewis.I.M.. A pastoral democracy.. Oxford. 1961
- Livingstone.F.B. A formal analysis of prescriptive  
marriage systems. S.W.J.A. 15. pp. 361-72 1959
- Makrizi. Abhandlung über die in Ägypten eingewanderten  
arabischen Stämme. Wüstenfeld. Göttinger Studien.1947
- Mayer.U.P. The lineage principle in Gusii society.  
International African Institute. London. 1949

- Meyer.A.J. Middle East Capitalism. Cambridge.Mass. 1959
- Monteil.. The evolution of and settling of nomads of the Sahara. I.S.S.J. vol.XI no.4 1959
- Muhson.H. Sedentarisation of the Bedouin in Israel. I.S.S.J. vol.XI no. 4 1959
- Murphy.R.F. & Kasdan.L.. The structure of parallel<sup>cousin</sup> marriage. A.A. 61 pp. 17-29 1959
- Murphy.R.F. & Kasdan.L.. Agnation and endogamy. Some further considerations. S.W.J.A.. vol.25 no.1 pp. 1-14
- Panetta.E. L'Italia in Africa. Roma.. 1963
- Patai.R.. Cousin right in Middle East marriage.. S.W.J.A. vol.11 1955
- Patai.R. The dynamics of westernisation in the Middle East.. M.E.J. vol. 9 no.1 pp.1-10 1955
- Patai.R. The structure of endogamous unilineal descent groups. S.W.J.A.. vol. 21 pp.325-350 1965
- Peel.R.F. The Tibu peoples and the Libyan desert. Geographical Journal. vol.100 pp.73-87 1942
- Peters.E.L. The Sociology of the Bedouin of Cyrenaica. D.Phil. Thesis. Oxford. 1951
- Peters.E.L. The proliferation of segments in the lineage of the Bedouin of Cyrenaica. J.R.A.I. vol. 90 pp. 29-53. 1960
- Peters.E.L. Aspects of the family among the Bedouin of Cyrenaica. in: Comparative Family Systems. Nimkoff. Boston. 1965
- Peters.E.L. The tied and the free. in: Contributions to Mediterranean Sociology. ed. Peristiany. Paris. 1966
- Peters.E.L. Some structural aspects of the feud among the camel-herding Bedouin of Cyrenaica. Africa. vol. XXXVII no.3 pp.261-282 1967

- Ratzel.F. Anthropogeographie. Stuttgart. 1909
- Renouf.P.le P.. Who were the Libyans? Proceedings of Biblical Archaeology. C.I. pp. 599-603 June 1891
- Report of the Cambridge Expedition to Cyrenaica. 1959
- Reuben.L.. The Social Structure of Islam. Cambridge. 1962
- Rosenfeld.H. Processes of structural change within the Arab village extended family. A.A.. 60 pp..1127-39. 1958
- Rosenfeld.H.. The social composition of the military in the Arabian Desert. J.R.A.I. vol.95 part. 1 1965
- Sabatini.A. Antropologie der Tebu von Kufra. Zeitschrift für Rassenkunde. pp. 253-269 3. 1936
- Sahlins.M.D.. Tribesmen. Prentice-Hall. 1968
- Salim.S.M.. Marsh Dwellers of the Euphrates Delta. L.S.E. Monographs on Social Anthropology. 1962
- Salzman.P.. Political organization among nomadic peoples.. Proceedings of the American philosophic society. pp. 115-131 1967
- Schenfield.H.S. Libya. Islam Today. London. 1943
- Schiffers.H. Libyen und die Sahara. Bonn. 1962
- Smith.M.G.. Segmentary lineage systems. J.R.A.I. LXXXVI pp.. 39-80 1956
- Smith.W.R.. Kinship and Marriage in Early Arabia. London. 1907
- Sulaim.Bani. Encyclopaedia of Islam. S-Z 1934
- Sweet.L.E.. Camel pastoralism in North Arabia and the minimal camping unit. in: Leeds & Vayda.Man,Culture and Animals. 1965
- Thomas.F.C. The Libyan oil worker. M.E.J. Summer 1961
- Toni.Y.T.. The Social Geography of Cyrenaica. Ph.D. Thesis. Newcastle-u-Tyne. 1956
- Villard. Libya. The new Arab kingdom of North Africa. Cornell. 1956

- Weber.M. Theory of Social and Economic Organization.  
London. 1947
- Willimot and Clarke. eds. Field Studies in Libya. Research  
Papers. Dept. of Geography. University of Durham.
- Winkler.H.A. Bauern zwischen Wasser und Wüste. Kohlhammer.  
Stuttgart. 1934
- Ziadeh.N.A. Sanusiyah. E.J.Brill. Leiden. 1958