

Durham E-Theses

The determination of the crystal structure of diammonium vanadyl oxalate dihydrate

Oughtred, R. E.

How to cite:

Oughtred, R. E. (1973) *The determination of the crystal structure of diammonium vanadyl oxalate dihydrate*, Durham theses, Durham University. Available at Durham E-Theses Online:
<http://etheses.dur.ac.uk/10060/>

Use policy

The full-text may be used and/or reproduced, and given to third parties in any format or medium, without prior permission or charge, for personal research or study, educational, or not-for-profit purposes provided that:

- a full bibliographic reference is made to the original source
- a [link](#) is made to the metadata record in Durham E-Theses
- the full-text is not changed in any way

The full-text must not be sold in any format or medium without the formal permission of the copyright holders.

Please consult the [full Durham E-Theses policy](#) for further details.

THE DETERMINATION OF THE CRYSTAL STRUCTURE
OF
DIAMMONIUM VANADYL OXALATE DIHYDRATE

A thesis submitted for the Degree of Master
of Science in the University of Durham

by

R. E. OUGHTRED F.R.I.C.

September 1973



ABSTRACT

The development of the structural chemistry of oxalates and vanadyl complexes is reviewed.

The structure of diammonium vanadyl oxalate dihydrate has been determined by x-ray analysis, using photographic and counter methods of data collection. The counter method gave an R factor of 0.039 and produced atomic coordinates with a satisfactory degree of accuracy.

Contrary to predictions based on spectroscopic evidence, the vanadium atom is six coordinate, the anion $[\text{VO}(\text{C}_2\text{O}_4)_2\text{H}_2\text{O}]^{2-}$ containing a distorted octahedral arrangement of oxygens about the metal atom. The two chelated oxalato groups have a cis arrangement with respect to one another and a water molecule occupies an apical position trans to the vanadyl group.

A comparison of vanadium to oxygen bond lengths with corresponding vanadium to ligand distances in other octahedral vanadyl complexes, shows that there is a general agreement.

The bond lengths in the oxalato groups also agree with those in similar structures. The effect of the V = O group on C - O bond lengths in the trans chelated oxalato group has been observed and this accords with results reported by other workers.

The water molecules and ammonium ions generate a network of hydrogen bonds in which all the oxygen atoms are involved.

PREFACE

This thesis describes work carried out at the University of Durham and the Newcastle upon Tyne Polytechnic and acknowledgement is hereby made to the governing bodies of these Institutions for the provision of research facilities.

I wish to express my gratitude to my supervisor, Dr. H. M. M. Shearer of the University, for his guidance and his patience.

My sincere thanks are also due to Mr. E. S. Raper of the Polytechnic, who suggested the problem, for his helpful advice and for his personal example.

The assistance, in various ways, of Drs. T. C. Downie, G. A. Form, D. A. Sowerby and of Mr. Philip Oughtred, is also gratefully acknowledged.

CONTENTS

Abstract	
Preface	
Introduction	1
CHAPTER I A SURVEY OF RELATED STRUCTURES	5
1.1 Introduction	5
1.2 The structure of vanadium complexes	5
1.2.1 Vanadylsulphate heptahydrate	5
1.2.2 Vanadyl bisacetylacetonate	6
1.2.3 Diammoniumoxotetrakis(isothiocyanato)vanadate pentahydrate	8
1.2.4 Ammonium vanadyl (+) tartrate monohydrate	8
1.2.5 Vanadyl(IV)pyridine 2,6dicarboxylate tetrahydrate	11
1.2.6 Triammonium bisoxalatodioxovanadate(V) dihydrate	12
1.3 The structure of oxalates and oxalato complexes	13
1.3.1 The structure of oxalic acid and its salts	14
1.3.2 Ammoniumoxalate monohydrate	15
1.3.3 Oxalic acid	15
1.3.4 Sodium oxalate	15
1.3.5 Oxalic acid	18
1.3.6 Potassium oxalate monohydrate	18
1.3.7 Ammonium hydrogen oxalate hemihydrate	18
1.4 The structure of oxalato complexes	19
1.4.1 Trans potassium dioxalatodiaquochromiate	19
1.4.2 Copper ammonium oxalate dihydrate	20
1.4.3 Neodymium III oxalato 10.5 hydrate	21
1.4.4 Bariumoxalatomolybdate pentahydrate	21
1.4.5 Diammoniumdiuranyltrioxalate	23

1.4.6	Uranyloxalate trihydrate	23
1.5	Hydrogen bonding in crystalline solids	23
CHAPTER II THE PREPARATION AND CONSTITUTION OF AVO		29
2.1	The preparation of AVO	29
2.2	Congeners of AVO	30
2.3	Thermal dehydration of AVO	31
2.4	Molecularity of AVO	34
2.5	The infrared spectrum of AVO	35
2.6	The electronic absorption spectrum	37
CHAPTER III STRUCTURE DETERMINATION BY X-RAY ANALYSIS - THEORETICAL CONSIDERATIONS		39
3.1	Introduction	39
3.2	The reciprocal lattice	40
3.3	The structure factor	44
3.4	Special forms of the structure factor	47
3.5	The applications of Fourier methods	48
3.6	The phase problem	49
3.7	The Patterson function	49
3.8	The heavy atom method	50
CHAPTER IV THE DETERMINATION OF THE STRUCTURE OF AVO		52
4.1	Introduction	52
4.2	The photographic method	52
4.2.1	The cell constants	52
4.2.2	Intensity data collection	52
4.2.3	Indexing of reflections	54
4.2.4	Measurement of integrated intensities	54
4.2.5	Data reduction	54

4.2.6	Structure determination and refinement	54
4.3	The counter method	57
4.3.1	Operating principles of the diffractometer	57
4.3.2	Measurement of unit cell dimensions	60
4.3.3	Intensity data collection	61
4.3.4	Data reduction	61
4.3.5	Structure determination and refinement	62
4.3.6	Atomic parameters	64
4.3.7	Structure factors	64
CHAPTER V THE CRYSTAL AND MOLECULAR STRUCTURE OF AVO		74
5.1	Introduction	74
5.2	The structure of the AVO anion	74
5.2.1	The coordination cage of the vanadium atom	74
5.2.2	Interatomic distances and bond angles in the octahedron	76
5.2.3	Oxygen-oxygen distances	77
5.2.4	The trans influence of the vanadyl group	78
5.3.1	The stereochemistry of the oxalato groups	78
5.3.2	The aplanarity of the oxalato groups	81
5.3.3	Bond lengths and angles in the oxalato groups	82
5.3.4	The trans influence in relation to bond lengths in the oxalato groups	85
5.4	The ammonium ions	87
5.5	The water molecules	88
5.6	Molecular packing and hydrogen bonding in the structure	88
5.7	Summary	91

LIST OF TABLES

2.1	The infrared spectrum of AVO	36
4.1	AVO constants	53
4.2	AVO, non-hydrogen atomic positional parameters (photographic data)	58
4.3	AVO, non-hydrogen atomic anisotropic temperature factors (photographic data)	59
4.4	AVO, agreement analysis	63
4.5	AVO, non-hydrogen atomic positional parameters (counter data)	65
4.6	AVO, hydrogen atomic positional parameters	66
4.7	AVO, non-hydrogen atomic anisotropic temperature factors (counter data)	67
4.8	AVO, observed and calculated structure factors	68
5.1	Mean planes	93
5.2	Interatomic distances	94
5.3	Bond angles about vanadium atom	94
5.4	Bond lengths in octahedral vanadium complexes	95
5.5	Vanadyl bond lengths	96
5.6	Mean planes in oxalato group	97
5.7	Mean planes in oxalato group	98
5.8	Planarity of complex oxalates	99
5.9	Average bond lengths and angles in complex and simple oxalates	100
5.10	Comparison of C - O bond lengths	101
5.11	Bond lengths and angles in the ammonium ions and water molecules	102
5.12	Close approaches to nitrogen and water oxygen atoms	103
5.13	Hydrogen bonding parameters	104

INTRODUCTION

The compound ammonium bis-(oxalato) oxovanadium IV dihydrate $(\text{NH}_4)_2 \text{VO}(\text{C}_2\text{O}_4)_2 \cdot 2\text{H}_2\text{O}$ has certain features of interest concerning its molecular structure. These may be summarised as follows.

It incorporates the vanadyl (IV) ion (VO^{2+}) and as with oxocations of other transition metals, this plays an important part in the structure of the complex.

In a review of metal oxocations Selbin¹ pointed out that although some twenty different transition metals have been reported as forming MO_x^{n+} entities (where x may be 1, 2, or 3 and n may be 1, 2, 3, 4 or 5), firm structural evidence is lacking in all but a few cases.

The most stable oxocations are dioxouranium (VI) UO_2^+ and oxovanadium (IV) VO^{2+} and an extensive literature exists on the aquochemistry of compounds containing these ions. Selbin estimates the number of known complexes of the VO^{2+} ion at "well over a hundred". A literature survey however reveals that in only a few cases have molecular and crystal structures been established by X-ray diffraction techniques.

The main reason for the interest in oxycation structures in general, is that the metal-oxygen multiple bond is very strong and remains intact during ligand changes in the coordination complex. The length of this bond however may change with different ligand environments and these changes may be correlated with the properties of the various ligand-metal bonds concerned.

Selbin^{2,3} has reviewed the chemistry of oxovanadium (IV) and states that the particular significance of this ion derives from

the following circumstances:

- (a) the oxovanadium (IV) ion is probably the most stable biatomic ion known.
- (b) it forms stable complexes which may be anionic, cationic or neutral. These may exist in the solid, liquid or vapour states.
- (c) the ion is a d^1 system and the fact that it possesses only a single electron outside a closed shell makes it particularly suitable for fundamental theoretical studies.

The oxalate group as a bidentate ligand was the subject of a review by K. V. Krishnamurty and C. M. Harris⁴. It is of special interest in the case of metal atoms where octahedral structures are formed. Bisoxalato complex ions of the general formula

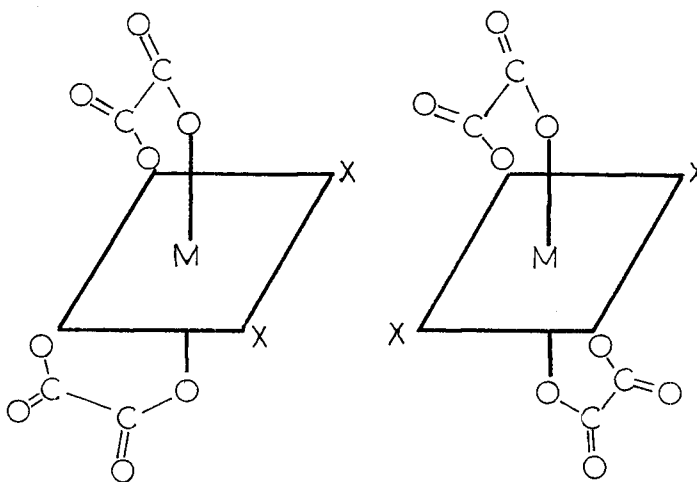
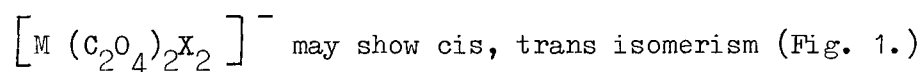

FIG. 1

A number of structural studies of both simple and complex oxalates have contributed information on the bond order of the C - C link and the planarity of the oxalate group. The nature of the hydrogen bonding in hydrated oxalates has also received considerable attention.

From an investigation of the infrared spectrum of diammonium vanadyl dioxalate dihydrate (hereafter referred to as AVO), Sathyararayana and Patel⁵ suggested the structure in Fig. 2 for the complex anion.

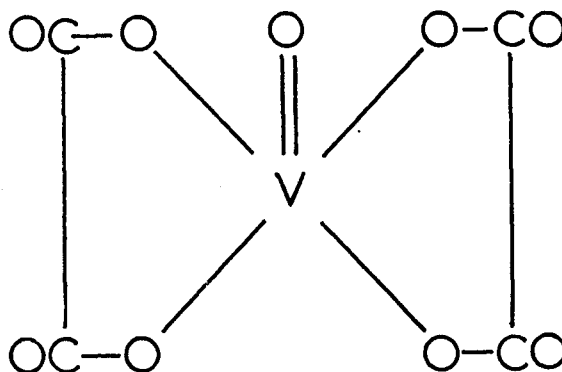

FIG. 2

The present work shows that the anion includes a coordinated water molecule and this allows an octahedral arrangement of oxygen atoms about the vanadium atom. This is in contradiction to the square pyramidal structure proposed above.

These authors considered that both the water molecules were present as lattice water and assigned to the compound the formula $(\text{NH}_4)_2 [\text{VO}(\text{Ox})_2] \cdot 2\text{H}_2\text{O}$. The results of the present X-ray analysis

indicate that the correct formula is $(\text{NH}_4)_2 [\text{VO}(\text{Ox})_2 \cdot \text{H}_2\text{O}] \cdot \text{H}_2\text{O}$.

Another aspect of interest is the therapeutic properties of vanadyl coordination complexes. U. S. patent No. 3,076,830 relates to the use of AVO and other complexes in the treatment of tumours.

It was thought that the determination of the molecular structure of AVO would make a contribution to the various issues to which reference has been made.

CHAPTER ONE

CHAPTER I1. INTRODUCTION

A considerable number of papers have been published concerning the structures of compounds which contain ions or other entities similar to those found in AVO. These compounds fall into three groups.

- (a) Coordination compounds of vanadium (IV) and (V).
- (b) Oxalates and oxalato complexes of vanadium and other metals.
- (c) Compounds containing water molecules and ammonium ions which participate in hydrogen bonding.

In reviewing this literature emphasis is placed on the results obtained by X-ray analysis but contributions from other techniques will be discussed as appropriate. In order to show the development of the subject the papers will be discussed chronologically.

Detailed consideration of molecular geometry is deferred, and relevant comparisons with AVO will be made in Chapter V.

1.2 THE STRUCTURE OF VANADIUM COMPLEXES

The structure of vanadium pentoxide was established by Bystrom, Wilhelmi and Brotzen⁶ confirming earlier work of Keletaar⁷. Each vanadium atom was found to be coordinated to five oxygen atoms in a form which was described as a trigonal bipyramid.

The V - O distances were reported to range from 1.54 Å to 2.02 Å. No comment was made as to the possible significance of the short bond.

- 1.2.1 Vanadyl Sulphate Heptahydrate ($\text{VO}_2 \cdot 5\text{H}_2\text{O}$) was investigated by Palma-Vittorelli, Palma, Palumbo and Sgarlata⁸ for the specific purpose of establishing whether the vanadyl-oxygen link had the

character of an ionic or covalent bond.

They found an octahedral distribution of six oxygen atoms around the vanadium, the four longest bonds involving water oxygens. The remaining V - O bonds were 1.67 Å and 1.86 Å in length and the shortest was identified as the vanadyl group (V = O). It was not stated whether the sixth oxygen was provided by the remaining water molecule or the sulphate group.

The observed interatomic distance (1.67 Å) was significantly less than the sum of the atomic radii (1.94 Å) and it was concluded that "a double covalent bond is established between the two atoms".

Studies of magnetic and optical properties reported in the same paper supported this view.

The question of hydrogen bonding in the crystal was not considered.

1.2.2 The structure of vanadyl bis acetylacetonate was determined by Dodge, Templeton and Zalkin⁹. As shown in Fig. 1.1, the five oxygen atoms which form the cage of the metal atom are situated at the corners of a square pyramid, the vanadium being slightly elevated from the centre of the base.

FIG. 1.1

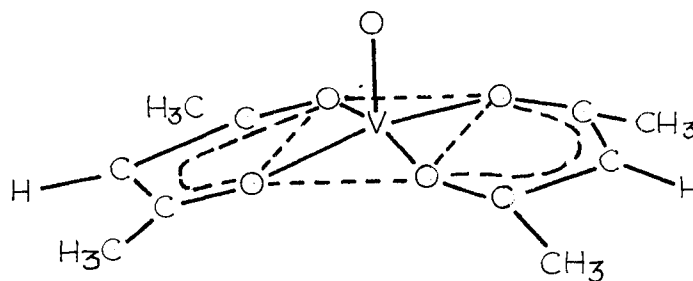

The elevation of the vanadium atom above the basal plane was thought to be due to the repulsion of the two chelate rings by the $V = O$ group. They point out the similarity between this distribution of oxygen atoms and that in V_2O_5 , preferring to interpret the structure of the latter as a distorted square pyramidal arrangement, as opposed to the trigonal bipyramid suggested by Bystrom et al.

The authors point out the significance of the shortness of the $V = O$ bond, apparently unaware of the prior work of Palma-Vitorelli et al.

Gillespie¹⁰ has observed that $VO(acac)_2$ is an exception to the general rule that square pyramidal molecules of the transition elements with incomplete d shells have longer axial bonds than base bonds, and ascribes this to the multiplicity of the $V = O$ bond. He points out that AX_5 coordination involving multiple bonds usually has trigonal bipyramidal geometry and the expected arrangement around the metal atom would have the short bond in the equatorial plane as in Fig. 1.2.

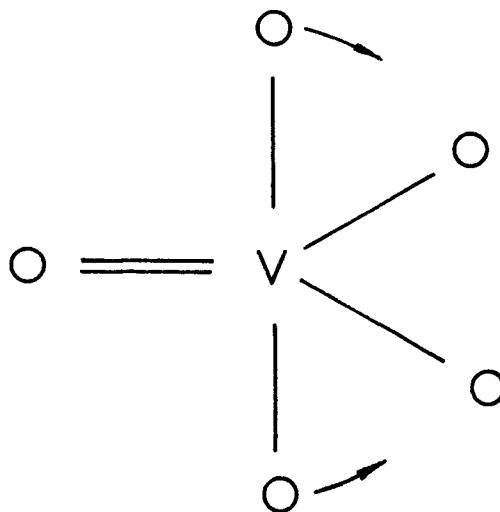

FIG. 1.2

The multiple bond however repels the axial oxygens and distorts the structure into an approximately square pyramidal form. Thus what would normally have been an equatorial bond is now axially disposed.

1.2.3 The substance diammonium oxotetrakis-isothiocyanatovanadate pentahydrate $(\text{NH}_4)_2 \text{VO} (\text{NCS})_4 \cdot 5\text{H}_2\text{O}$ was found by Hazell¹¹ to have a six coordinate metal atom.

The vanadium atom is coordinated to the vanadyl oxygen and to the nitrogen atoms of the isothiocyanate groups. These five atoms are situated at the corners of a tetragonal pyramid and the octahedral position is occupied by a water oxygen trans to the vanadyl oxygen.

The possibilities of hydrogen bonding involving the water molecules and ammonium ions were not discussed but it was noted that each ammonium ion was surrounded by four oxygen atoms arranged at the corners of a distorted tetrahedron.

1.2.4 Ammonium Vanadyl (+) Tartrate Monohydrate was the first vanadyl complex containing dicarboxylate groups, to be examined by X-ray methods. Forrest and Prout¹² found that the structure consisted of dimeric vanadyl tartrate units $[\text{VO} (\text{d-tart})]_2^{4-}$, isolated ammonium ions and water molecules (See Fig. 1.3)

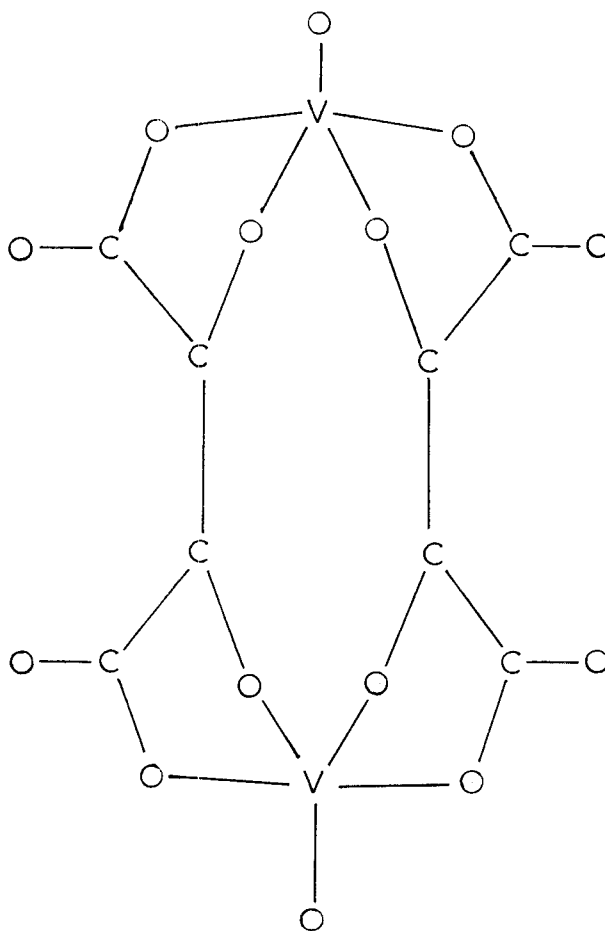

FIG. 1.3

The arrangement of the five oxygen atoms about the metal atom is that of a distorted trigonal bipyramid. The carboxyl oxygen

atoms are at the apices and the vanadyl oxygen together with the two deprotonated hydroxyl oxygen atoms form the triangle of the equatorial plane. These last three atoms are coplanar with the metal atom and this establishes the geometry of the oxygen cage as a trigonal bipyramid.

Although only the positions of the heavy atoms were found, reasonable inferences were drawn concerning hydrogen bonding in the crystal. The vanadyl tartrate ions are arranged in sheets parallel to the (001) crystal plane. The sheets are linked by hydrogen bonds provided by the ammonium ions and water molecules as follows:

Each water molecule forms three hydrogen bonds:

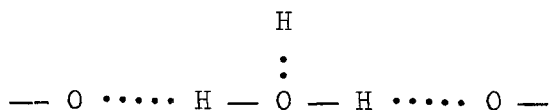

The bonds $\cdots \cdots \text{H} \text{--- O} \text{--- H} \cdots \cdots$ connect the deprotonated hydroxyl oxygen atoms of two different dimeric units of the same sheet.

The remaining bond connects the water molecule to an ammonium ion which itself is hydrogen bonded to vanadyl tartrate ions in the next sheet.

All the hydrogen atoms in the two ammonium ions take part in bonding the vanadyl tartrate units together. However the two ions perform distinctive functions in that one serves to bond adjacent tartrate ions within a particular sheet, whereas the other joins neighbouring sheets together.

The solving of this structure lends convincing support to the prediction of Tapscott and Belford that the substance is dimeric in alkaline solution. The correlation between the reflectance spectrum

of the crystalline solid and the infrared spectrum of its alkaline solution confirm that it has the same ionic constitution in both forms. Tapscott, Belford and Paul¹³, determined the structure of tetrasodium divanadyl (IV) d-tartrate l-tartrate dodecahydrate.

It was found that the vanadium environment differs significantly from that in the $[\text{VO}(\text{d-tart})]_2^{4-}$ ion. It is square pyramidal with the vanadyl oxygen at the apex and the oxygens at the corners of the base are contributed by one d-tartrate bridge and one l-tartrate bridge disposed in the cis position.

The scheme proposed for hydrogen bonding is complex. The dimers have a sheet-like structure and these sheets are considered to be held together by a combination of hydrogen bonds, ion dipole bonds and ionic bonds.

- 1.2.5 Vanadyl (IV) pyridine 2,6 dicarboxylate tetrahydrate was found by Bersted, Belford and Paul¹⁴ to have a six coordinated metal atom in a distorted octahedral cage which approximates to C_{2V} symmetry. (Fig. 1.4).

FIG. 1.4

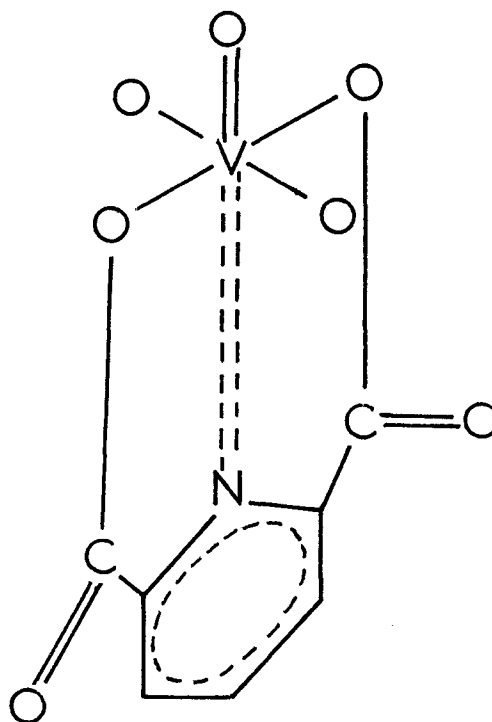

The equatorial plane has two carboxylate oxygens in the trans position and two water oxygens similarly disposed. The pyridine ring, the vanadyl group and the two carbon atoms are coplanar with the carboxylate oxygens and this gives the structure C_{2V} symmetry.

The configuration of the five oxygen atoms about the vanadium is that of a distorted trigonal bipyramid and is thus similar to the vanadyl d-tartrate ion. The vanadyl oxygen and the carboxylate oxygens form the equatorial plane in the centre of which the metal atom is situated.

The crystal is built up of molecules of $(VO C_7H_3O_4N \cdot 2H_2O)$ and it is suggested that they are linked together in the crystal by the remaining uncoordinated water molecules through hydrogen bonds.

It is assumed that each coordinated water molecule forms two hydrogen bonds with suitably placed proton acceptors. These acceptors are considered to be an uncoordinated carboxyl oxygen in another molecule and a water of hydration. The latter molecule further participates in the hydrogen bonding by linking uncoordinated oxygen atoms associated with two different molecules.

1.2.6 A number of structures containing the dioxovanadate (V) ion have been reported.

Triammonium bis (oxalato) dioxovanadate (V) dihydrate was investigated by Scheidt, Tsai, and Hoard¹⁵, using a four circle diffractometer. The structures previously described had been solved using photographic methods of recording data and only the positions of the non-hydrogen atoms were experimentally determined. The higher level of accuracy of the diffractometer data gave the positions of all atoms. However the authors did not offer any

suggestions as to hydrogen bonding patterns in the crystal.

The bis (oxalato) dioxovanadate (V) anion $[\text{VO}_2 (\text{Ox})_2]^{3-}$ is similar to the anion of AVO in that the metal atom is surrounded by an octahedral distribution of oxygens (Fig. 1.5). The difference lies in the fact that the position of the coordinated water oxygen in AVO is occupied by the second oxo-oxygen in the anion.

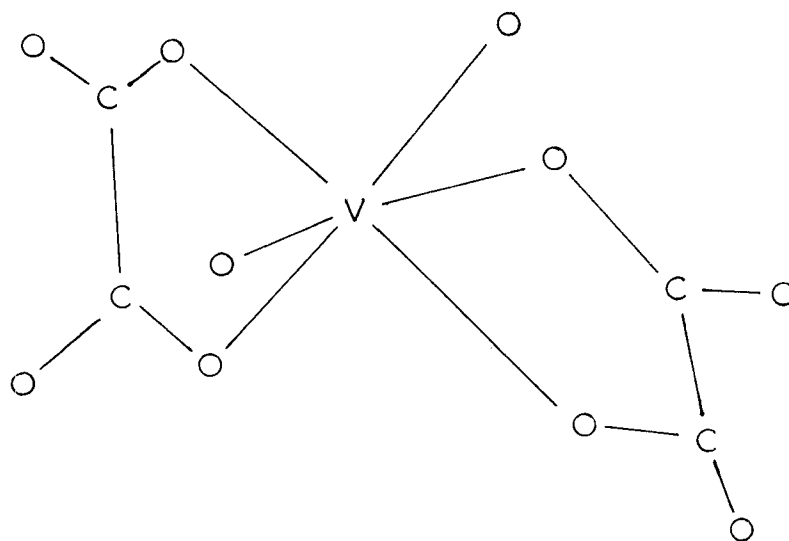

FIG. 1.5

1.3 THE STRUCTURE OF OXALATES AND OXALATO COMPLEXES

The first paper concerning the structure of the oxalate group was published by Zachariasen¹⁶ in 1934, and the subject has since been widely studied.

Attention has focussed mainly on the following points:

- (a) the bond order of the C - C linkages.
- (b) the planarity or aplanarity of the oxalate group.

- (c) the equivalence of the C - O groups.
 (d) hydrogen bonding effects (in the cases of acid molecules, hydrated compounds and ammonium salts).

This review of previous work falls into three parts, viz. simple oxalates, oxalato complexes and hydrogen bonding in the crystalline state relating to such substances.

1.3.1 The Structure of Oxalic Acid and Its Salts

The earliest work concerning oxalic acid dihydrate^{17,18} was based on two dimensional data and yielded discrepant values of bond lengths and angles. In 1947 the published data was evaluated by Dunitz and Robertson¹⁹ who proposed the structure (using the most probable interatomic distances) shown in Fig. 1.6.

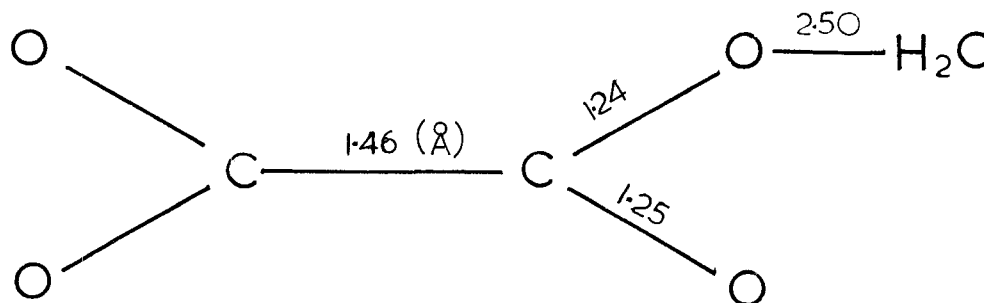

FIG. 1.6

The shortness of the C - C link as compared with the value of 1.544 Å, found in diamond, was taken as evidence of conjugation. The fact that the oxygen and carbon atoms are coplanar supports the view that this linkage partakes of the nature of a double bond.

The accuracy of the data did not allow the positions of the hydrogen atoms to be determined but the presence of hydrogen bonds was inferred from the positions of the water molecules. The function of the hydrogen bonds is twofold, joining the oxalic acid units into

chains and joining the chains together in a three dimensional network.

1.3.2 In 1952 Jeffrey and Parry²⁰ determined the structure of ammonium oxalate monohydrate. This work confirmed the results of an earlier study by Hendricks and Jefferson²¹ which showed that in contrast to the oxalic acid molecule, the oxalate ion is aplanar. The angle between the planes of the two carboxyl groups is 28° .

The C - C bond length is 1.56 \AA and this was interpreted as a pure sigma bond. The absence of conjugation is thought to explain the rotation of the carboxyl planes. It was considered that in the absence of other influences, these planes would probably be at 90° to each other as this is the position of minimum interaction, but in the crystal the ammonium ion and water molecule have electric fields which inhibit this movement.

1.3.3 An interesting situation arose when the structure of α -oxalic acid was determined by Cox, Dougill and Jeffrey²², who showed that it contained a planar carboxylic acid group.

The observed value of 1.560 \AA for the C - C bond is slightly longer than the value of 1.54 \AA in diamond but the authors suggested that the discrepancy is due to experimental error and is of no significance. If then, the link is a pure single bond, an explanation is required as to why rotation of the planes of the carboxyl group has not occurred. They suggested that the C - C link is actually a single bond and that the planarity is due to a special attractive force between the carbonyl and hydroxyl groups attached to the carbon atoms.

In 1953 Ahmed and Cruickshank²³ reassessed published data for the

anhydrous α -oxalic acid and oxalic acid dihydrate. They proposed the bond lengths shown in Fig. 1.7.

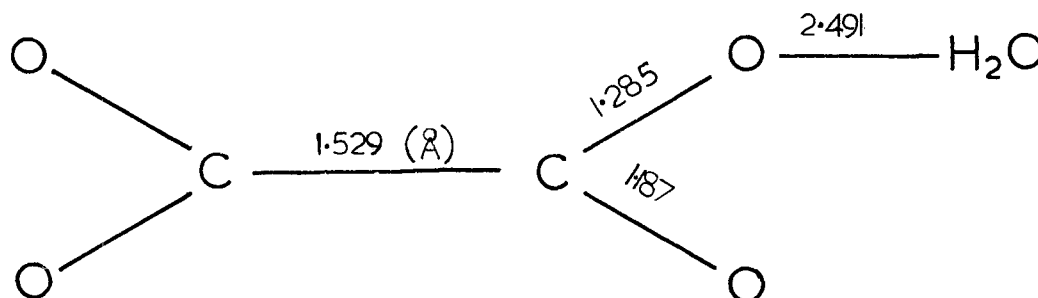

FIG. 1.7

The revised values for the C - C bond of the dihydrate do not support the conclusion of Dunitz and Robertson that planarity is due to π bonding. Furthermore the lengths of the C - O bonds have new and unequal values.

The authors noted that the bond lengths and angles in the two compounds corresponded closely. This suggests that the dihydrate consists of oxalic acid units and water molecules and not, as proposed by Dunitz and Robertson, oxalate and hydroxonium ions.

1.3.4 The question of why oxalic acid and its hydrates have planar molecules but ammonium oxalate is aplanar was again taken up by Jeffrey and Parry²⁴. They selected sodium oxalate as an appropriate subject for study because in the absence of hydrogen bonding, the ion should have an unperturbed environment.

The oxalate ion was found in fact to be accurately planar. This unexpected result caused the authors to reconsider their explanation (1.3.2) of the rotation of the carboxylate groups in ammonium oxalate monohydrate.

They now suggested that the C - C link can only have a small

amount of π bonding and they interpret the unusual circumstances of the oxalate ion having a different stereochemistry in two different salts as follows:

Two opposing effects are at work,

- (a) the polar repulsions of the carboxyl oxygens which tend to cause rotation about the C - C bond and
- (b) the electron configuration across this bond which tends to prevent rotation.

In the absence of any strong intermolecular forces, the effect of the conjugation predominates and the ion is planar. However in the case of ammonium oxalate monohydrate the requirements of the pattern of hydrogen bonds in the crystal are such that the carboxyl oxygens which are involved in the pattern are pulled into the aplanar configuration.

Thus the author's broad conclusion is that the aplanarity of the hydrated ammonium salt is a consequence of hydrogen bonding.

This view received further support when J. H. Robertson²⁵ carried out a three dimensional analysis at 30°K which confirmed that the oxalate ion is twisted by 27°. Robertson comments "There can be no doubt that it is the strong hydrogen bonding which is responsible for the twisted configuration of the oxalate ion". However the structures of ammonium and potassium tetroxalate have been determined by Currie, Speakman and Curry²⁶ using neutron diffraction methods and this work shows that the oxalate ions are coplanar despite the fact that the molecules are strongly hydrogen bonded in the crystal lattice.

The complexities of the situation were not diminished when Haas²⁷ showed that in potassium tetroxalate $K(HC_2O_4)(H_2C_2O_4) \cdot 2H_2O$

the oxalic acid molecules are planar whereas the acid oxalate groups are not.

- 1.3.5 Recently α -oxalic acid has been re-examined using more accurate techniques. Delaplane and Ibers²⁸ employed an automatic diffractometer for X-ray data collection and Sabine, Cox and Craven²⁹ used neutron diffraction. Both these investigations confirmed that the oxalate group is accurately planar.

The bond lengths and angles were determined with a high degree of accuracy and reference to these parameters will be made later.

- 1.3.6 Hodgson and Ibers³⁰ have re-examined potassium oxalate monohydrate using an X-ray diffractometer. The results confirm the main findings of previous investigators but it is found that the oxalate anion is not completely planar but consists of two parallel O - C - O planes separated by approximately 0.016 Å. It is pointed out that in spite of this separation the measured bond angles about the carbon atom total 360° and therefore this summation is an insensitive criterion of planarity. This work has also enabled comparisons to be made between the accuracies of X-ray and neutron diffraction techniques when applied to the same compound³¹.

- 1.3.7 Kuppers³² using a Siemens automatic diffractometer has found that ammonium hydrogen oxalate hemihydrate has a planar oxalate group together with a C - C bond (1.549 Å), which is long in comparison with the expected distance between carbons in sp² hybrid states. A theoretical explanation for the lengthening of this bond in the oxalate ion, has been given by Brown and Harcourt³³. They showed that it is caused by some delocalisation of oxygen lone pair electrons (2p electrons with atomic orbitals

symmetric with respect to the COO plane) into an antibonding σ orbital between the carbon atoms.

The data obtained was of sufficient accuracy to enable approximate coordinates of the hydrogen atoms to be obtained from difference maps. A hydrogen bonding scheme, using these coordinates, is suggested.

1.3.8 Surveying the work done on simple oxalates it would seem that the anion is usually planar or shows only a slight deviation from this geometry. Ammonium oxalate monohydrate is an exception to this rule.

The conditions which determine whether a given oxalate will have a planar structure are not yet firmly established.

1.4 THE STRUCTURE OF OXALATO COMPLEXES

X-ray analysis is especially useful in determining the structure of coordination complexes which may have alternative configurations in the solid state. A number of complex oxalato compounds have been investigated and their molecular geometry established. In general the bond lengths and angles of the oxalato ligands are similar to those found in simple oxalates.

1.4.1 The first paper in this field was published by van Niekerk and Schoening³⁴ and concerned trans potassium dioxalatodiaquochromiate.

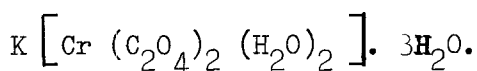

The four oxygens of the two oxalato groups which are coordinated to the chromium atom are coplanar with it. The octahedral cage is completed by the two oxygens belonging to the constitutive water molecules.

The C - C distance reported as 1.39 Å, is much shorter than the

authors expected and is ascribed by them to the poor resolution of these atoms. No indication is given in the paper as to the statistical accuracy of the atomic coordinates.

From the oxygen atom positions a complex network of hydrogen bonding is postulated which may be summarised as follows:

The structure consists of chains of molecules arranged in parallel fashion but not along any principal crystallographic axis. These chains form sheets which are stacked up the b axis. All five water molecules are involved in bonding together the chains and sheets.

Links between chains within a particular sheet involve uncoordinated water molecules in two distinct ways:

- (a) A water molecule forms an ionic bond with the K^+ ion in one chain and a hydrogen bond with a coordinated oxygen in a neighbouring chain.
- (b) A water molecule links two coordinated water molecules in two neighbouring chains by hydrogen bonds.

The links between adjacent sheets are also of a plural nature.

- (a) The water molecule in (a) above is also linked to a coordinated water molecule and to a terminal oxygen in the sheet immediately above.
- (b) The water molecule concerned in (b) above is also linked to two terminal oxygens in an adjacent layer.

1.4.2 Viswamitra³⁵ found that in copper ammonium oxalate dihydrate the metal atom has a square planar configuration with four oxalato oxygens. The two water molecules are on a line perpendicular to the plane and form a distorted octahedron about the central copper atom.

The C - C bond lengths in the two ions were 1.58 Å and 1.61 Å which suggested pure sigma bonds with little or no π configuration across the molecule. The oxalato groups were found to be slightly aplanar, the observed angular separation between the carboxyl planes being 11° and 15° in the two ions. The possibility of the ion being twisted was suggested with some diffidence in view of the limited accuracy of the data.

1.4.3 Hansson³⁶ found that in the structure neodymium (III) oxalate 10.5 hydrate, each oxalate group behaved as a tetradentate ligand to join two metal atoms. The environment of each neodymium atom is a polyhedron at the corners of which are located six carboxyl oxygens and three water oxygens.

As a consequence of the bridging of the metal atoms by the tetradentate oxalato groups, the crystal structure is composed of infinite neodymium oxalate networks arranged in layers. The water molecules are situated between these layers and give rise to hydrogen bonding to form a three dimensional structure.

The author reported that interatomic distances and bond angles corresponded with those generally found in simple oxalates.

Glen, Silverton and Hoard³⁷ found a similar relation in the case of tetrasodium tetrakis-oxalatozirconate (IV) trihydrate.

1.4.4 The coordination geometry of complex oxalates involving oxo cations other than $V = O$ is of interest.

Cotton and Morehouse³⁸ have shown that $\text{BaMoO}_4 \cdot (\text{C}_2\text{O}_4) \cdot 5\text{H}_2\text{O}$ contains the binuclear anion $\left\{ \left[\text{MoO} (\text{C}_2\text{O}_4) \text{H}_2\text{O} \right]_2 \text{O}_2 \right\}^{2-}$.

The most interesting aspect of the configuration of this dimeric anion is that it consists of two octahedral cages of

oxygen atoms around the metal atom which have a common edge. The oxygen atoms which act as a bridge at this common edge are in fact oxo oxygens. This contrasts with binuclear vanadyl structures^{12,13} where the bridging oxygens are provided by the chelating group.

The dimeric anion is shown diagrammatically in Fig. 1.8.

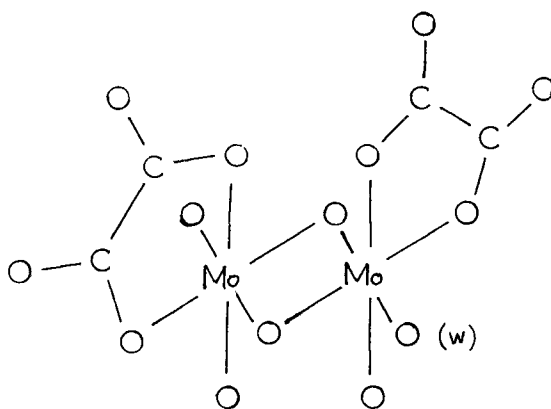

FIG. 1.8

It may be noted that, as in AVO, one of the water molecules is coordinated.

The configuration of the oxalato groups is generally in accordance with that of simple oxalates but, on the author's admission, the relatively low accuracy of the coordinates of the atoms does not allow significant discussion of bond lengths and angles.

1.4.5 Alcock³⁹ has reported that the structures of diammonium diuranyl trioxalate $(\text{NH}_4)_2 (\text{UO}_2)_2 (\text{C}_2\text{O}_4)_3$ contains a complex ion wherein the oxo oxygens play no part in the bridging process. In this case the oxalato groups act as tridentate and tetradentate ligands to join the metal atoms in infinite chains. This multiple coordination of the complex is thought to account for its marked stability in aqueous solution.

1.4.6 Jayadevan and Chackraburtt⁴⁰ have found a similar arrangement in uranyl oxalate trihydrate $\text{UO}_2 \cdot \text{C}_2\text{O}_4 \cdot 3\text{H}_2\text{O}$.

In this case all the oxalato groups are tetradentate and act as bridges between the metal atoms. A single water molecule is brought into the coordination sphere which consists of seven oxygen atoms. Five of these oxygens and the uranium atom form a plane which lies at right angles to the O - U - O axis. The oxalato groups occupy centrosymmetric positions and have a planar configuration.

A layer structure exists composed of parallel chains which may be represented by $[\text{UO}_2 (\text{C}_2\text{O}_4) \text{H}_2\text{O}]_n$ and these layers are connected by hydrogen bonding involving both the coordinated and uncoordinated water molecules.

Dehydration studies of this compound showed that two water molecules are lost at 100°C but the third is retained up to 170°C. It was suggested that the coordinated water is more strongly bound than the lattice water. Isothermal dehydration of AVO however has showed that, in this particular case, there is no sharp differentiation.

1.5. HYDROGEN BONDING IN CRYSTALLINE SOLIDS

1.5.1 AVO contains both water molecules and ammonium ions and in consequence it would be expected that hydrogen bonding would play a significant part in the crystal structure.

The role of water molecules in organic molecular structures has been reviewed by Clark⁴¹ and general treatments of hydrogen bonding are given in texts by Hamilton and Ibers⁴² and Vinogradov and Linnell⁴³.

1.5.2 It is generally accepted that when two electronegative atoms, at least one of which is covalently bonded to a hydrogen atom, are found to be separated by less than the normal van der Waals contact distance, then hydrogen bonding may be inferred, even though the precise position of the hydrogen atom is not known.

A more sensitive criterion, which however requires a knowledge of the position of the hydrogen atoms, is that the distance from the hydrogen to the acceptor be considerably less than the sum of their van der Waals radii. This is illustrated by the various types of hydrogen bond which occur in AVO. The table compares the separation distances of the heavy atoms (a) as calculated from known values of van der Waals radii and (b) as observed from diffraction data. It also compares on the same basis the distances between the hydrogen and the acceptor atom.

Bond Type	AB	A B	H B	H B
Donor Acceptor	(Calc.)	(Obs.)	(Calc.)	(Obs.)
O — H O	2.8	2.7	2.6	1.7
O — H N	2.9	2.8	2.7	1.9
N — H O	2.9	2.9	2.6	2.0

1.5.3 Quantitative discussion of the lengths of hydrogen bonds in a particular compound, requires an accurate knowledge of the positions of the atoms concerned and it is of interest to compare the two main methods available, viz: X-ray and neutron diffraction.

X-rays are scattered by the extra nuclear electrons so that the scattering factor of an atom decreases with increasing Bragg angle θ and at $\theta = 0^\circ$ equals the atomic number. Thus the peaks in electron density maps representing hydrogen atoms are small and ill-defined. This is especially the case if they are vibrating to a considerable degree. It is usual to attempt to locate the hydrogen positions from difference maps, where the electron density due to other atoms has been subtracted out, but in many cases it is difficult to distinguish peaks of such small size from the general background electron density.

By contrast, neutrons are scattered by the atomic nuclei. The scattering amplitudes are therefore independent of θ and have a range of about 3. Because of this, the peaks due to hydrogen in a $F_o - F_c$ synthesis are of approximately the same height as the heavy atom peaks and therefore yield coordinates of the same degree of accuracy.

1.5.4 Baur⁴⁴ has developed methods of calculating the probable positions of hydrogen atoms and thereby of hydrogen bonds, based on the known positions of the heavy atoms which may act as donors or acceptors. Using a computer programme (CALHPO) the position of the hydrogen atom is varied until that corresponding to the least electrostatic energy in the system $(M)_n - A - H \cdots B - (X)_m$, is found.

In a series of inorganic hydrates the hydrogen positions as calculated by this method, were in significantly better agreement with results obtained by neutron diffraction studies than were the corresponding parameters based on X-ray data. Baur has proposed a

considerable deviations occur. This "flexibility" of water geometry is thought to enable the molecule to act as a strain absorber and allow close packing of other atoms and molecules. Linearity of the bond $W - H \dots O$ is not a required condition and the $W - O$ distance was found to vary between 2.6 and 3.2 Å.

1.5.6 Another aspect of the flexibility of the hydrogen bond is furcation, whereby a covalently bound hydrogen atom forms weak hydrogen bonds with two or three acceptor atoms. A bifurcated bond may be represented.

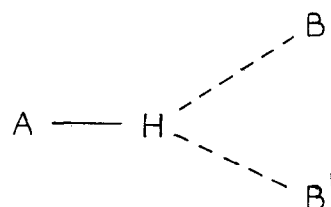

Examples of this type of bond have been found in inorganic hydrates ($MgSO_4 \cdot 4H_2O$ ⁴⁶) and in organic hydrates ($NH_4HC_2O_4 \cdot \frac{1}{2}H_2O$ ³²).

Donahue⁴⁷ has discussed the structures of glycine and glycine hemihydrochloride which have bifurcated hydrogen bonds involving hydrogens covalently attached to nitrogen atoms.

1.5.7 The first hypotheses concerning the hydrogen bond were suggested by Oddo and Puxeddu in 1906⁴⁸ and these were given concrete form by Latimer and Rodebush in 1920. Since this time it has become recognised as a fundamental factor in crystallochemistry, acting as it were, as the link which joins together certain chemical groupings

both intermolecularly and intramolecularly.

The specific effects of hydrogen bonding in the case of AVO, will be discussed in a later chapter.

CHAPTER TWO

CHAPTER II2. THE PREPARATION AND CONSTITUTION OF AVO2.1 PREPARATION OF AVO

The compound was first made by Koppel and Goldmann⁴⁹.

The crystals used in this work were prepared according to the procedure given by Palmer⁵⁰.

To 2.8 g. (1 mol.) of ammonium oxalate were added 10 g. (4 mol.) of oxalic acid dihydrate dissolved in the least volume of boiling water and then 4.6 g. (2 mol.) of ammonium metavanadate. When the evolution of CO₂ had ceased the solution was boiled for 5 mins. to complete the reduction. After the solution had cooled, 100 ml. of ethanol was added and the solution stood for 24 hrs.

The dark blue oil which had separated was parted from its supernatant liquor and agitated with 50 ml. of ethanol to induce crystallisation. The solid was collected and then agitated with 100 ml. of alcohol. The resulting solution was then filtered and allowed to stand 24 hrs. The crop of deep blue crystals was washed successively with ethanol and acetone.

The reaction may be represented as follows:

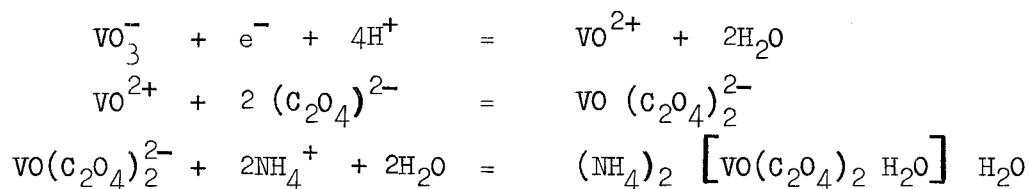

Further recrystallisations using ethanol and water mixtures as recommended by Palmer produced clusters of wafer-like crystals unsuitable for X-ray work. However it was found that isopropanol-water mixtures yielded isolated crystals of suitable dimensions.

The identity of the product was established by chemical analysis:

	<u>found</u>	<u>calc.</u>
vanadium (as VO)	20.8	21.3
oxalate	56.0	55.9
ammonium	11.5	11.4
water	11.7	11.4

2.2 CONGENERS OF AVO

The literature records the methods of preparation of other complex vanadyl oxalates related to AVO. Sathyanarayana et al⁵¹ have obtained vanadyl monoxalato dihydrate (I) and vanadyl monoxalato tetrahydrate (II). The following structures were assigned on the basis of absorption and infrared spectral data.

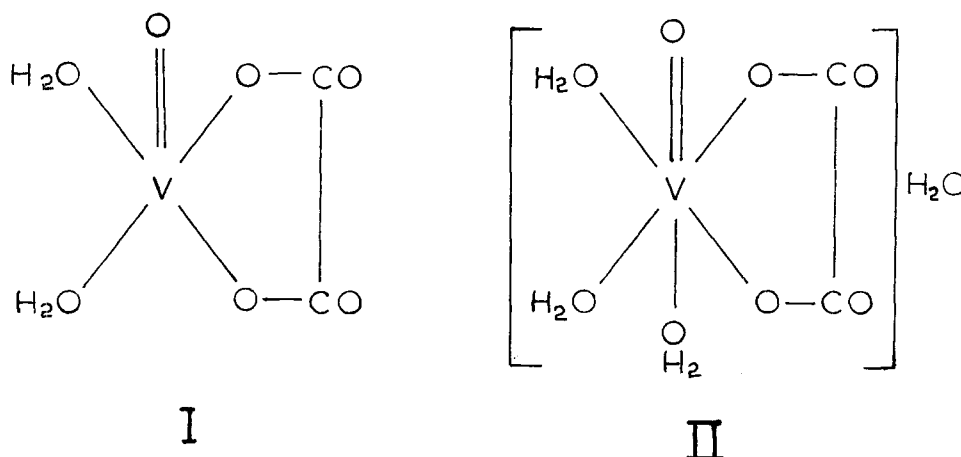

Koppel et al⁴⁹ also prepared diammonium divanadyl trisoxalato hexahydrate to which Sathyanarayana assigned the bridged configuration (III).

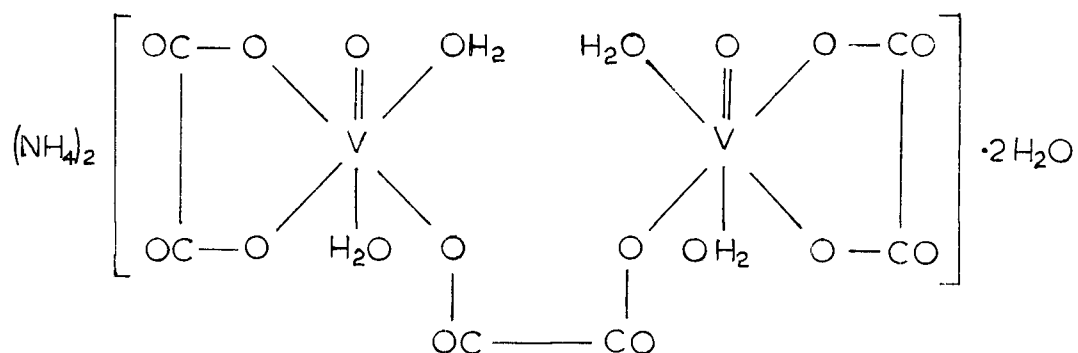

III

In the same paper they outline a method for the preparation of the anhydrous derivative of (III) and they suggest the following structure (IV).

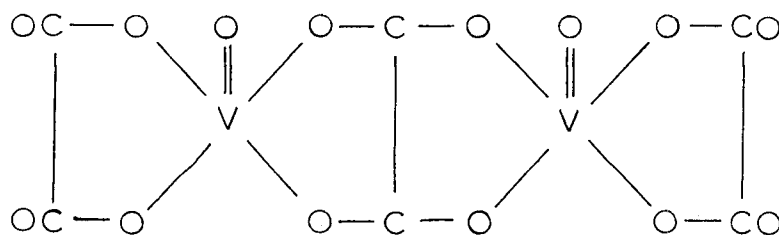

IV

None of the structures (I - IV) have as yet been confirmed by X-ray analysis.

2.3 THERMAL DEHYDRATION OF AVO

Sathyanarayana et al.⁵¹ found that AVO lost two water molecules under vacuum at room temperature. This suggested that both exist as loosely-held lattice water and thus supported the evidence of the infrared spectrum which indicated the absence of coordinated water

in the complex. Consequently they proposed that the compound should be represented as $(\text{NH}_4)_2 [\text{VO}(\text{Ox})_2] \cdot 2\text{H}_2\text{O}$. They suggested the structure (V) for the anion wherein the oxalato groups are bidentate and the anion has C_{2V} symmetry.

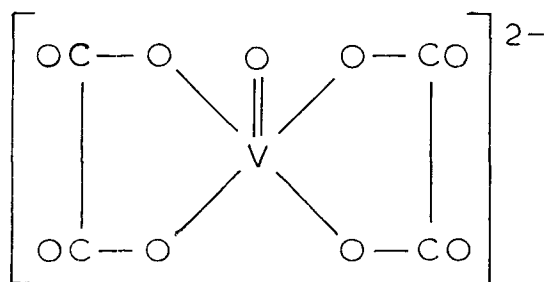

V

In order to determine whether a discrimination could be made between the coordinated and uncoordinated water in AVO it was examined by differential thermal analysis. The thermogram obtained with the C. I. Electronic Thermobalance Mk IIb shows a single step which indicates that the theoretical weight of water (11.4%), corresponding to two molecules, was lost between 105-145°C.

It was thought however, that isothermal heating at normal pressure may provide conditions under which stepwise dehydration would be observed.

The loss in weight of AVO was recorded at various temperatures using a "drying pistol". Isothermal conditions were maintained in the chamber by refluxing liquids in the surrounding jacket. Heating of the sample was continued until a constant weight was reached. The water evolved was trapped with P_2O_5 .

Using water as the heat transfer medium, a weight loss of 11.4% occurred. This corresponds to two molecules of water. When the water was replaced by dichloromethane giving a dehydration temperature of 41°C, the same result was obtained. The fact that AVO can be completely dehydrated at this low temperature, suggests that little distinction can be made between the strengths of attachments of the coordinated and uncoordinated water molecules. It is probable that hydrogen bonding forces involving these water molecules play some part in determining their behaviour.

These results confirm Sathyanarayana's view that the water molecules are loosely held, but the X-ray analysis shows that one of them is coordinated to the metal atom and is not lattice water as was supposed. It may be concluded that dehydration at low temperatures is not an infallible indication of lattice water.

It is interesting to note that anhydrous AVO (which has not been previously reported in the literature) is green in colour in contrast to the deep blue of the parent compound. The dehydration process must necessarily alter the coordination geometry about the metal atom and it seems possible that the structure of the anion may correspond to (V) which in fact was proposed for the anion of the dihydrate by Sathyanarayana.

He has also observed that the tetrahydrate (II) is converted into the dihydrate (I) by heating at 110°C or by dessication over P_2O_5 en vacuo at room temperature. In the case of the hexahydrate (III) he found that two molecules of water are readily lost under vacuum at ordinary temperatures, while the remaining four molecules are retained up to the decomposition temperature of the oxalate

groups. These results led to the assignment of the structures previously shown.

2.4 THE MOLECULARITY OF AVO AND SIMILAR COMPLEXES

In the absence of structural and spectroscopic data Palmer⁵⁰ suggested that the anion of potassium vanadyl oxalate $K_2 [VO(C_2O_4)_2] \cdot 2H_2O$ was dimeric, the two vanadium atoms being joined by a double oxygen bridge (VI).

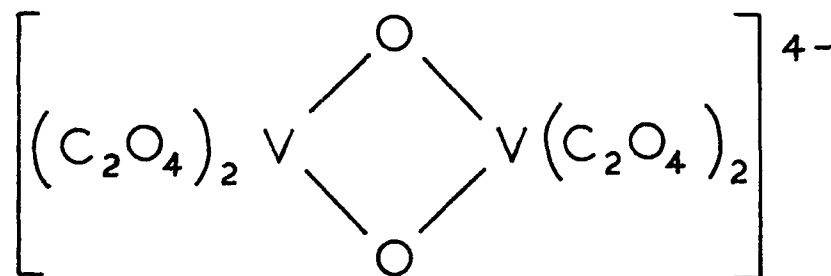

VI

Golding⁵² tested this hypothesis by E.S.R. techniques. If dimers were formed then the unpaired d electrons on the two metal atoms would interact and this would be revealed in the spectrum. In fact it was concluded that the ion is monomeric. Golding further suggested that the E.S.R. results and the U.V. spectrum indicated a pyramidal structure similar to that established by X-ray analysis for the bisacetylacetonate. He took the Z axis of the metal orbitals to lie along the line of the V = O bond and the X and Y axes to lie along the diagonals of the square formed by the four oxygens. The single d electron was assigned to the non-bonding d_{xy} orbital, this

being the d orbital of least energy for the square pyramidal configuration. This model was then used to account for the peaks in the electronic absorption spectrum, in terms of d - d transitions.

It is not entirely clear from Golding's paper whether the compound examined was potassium vanadyl oxalate dihydrate or ammonium vanadyl oxalate dihydrate and this ambiguity inhibits discussion. However if it is assumed that the two are isostructural then it can be stated that his conclusion that the ion is monomeric is supported by magnetic susceptibility data for AVO reported by Form⁵³, which showed that this compound has a single unpaired electron. Similar work by Sathyanarayana⁵¹ indicates that the dihydrate (I) and the tetrahydrate (II) are also monomeric.

2.5 THE INFRARED SPECTRUM OF AVO

A plot of the infrared spectrum was carried out on a Perkin Elmer 457 Grating Spectrophotometer. The assignment of the peaks given in Table 2(1) is in accordance with published data.

The spectrum of AVO was compared with that for the anhydrous compound and it was observed that the peaks at 3,560 and 3,440 cm^{-1} were absent in the latter case. Schmeltz et al⁵⁴ have assigned these bands to the stretching vibration of water of crystallisation.

TABLE 2.1

Infrared Spectrum of AVO

Wave Number (cm^{-1})	Assignment
3,560, 3,440	ν_a (H_2O)
3,140	ν (NH)
1,723	ν_a (C = O)
1,660, 1,678	ν_a (C = O)
1,400	ν_s (C - O) + ν (C = O) ν_2
1,277	ν_s (C - O) + δ (O - C = O) ν_8
1,250	ν_s (C - O) + δ (O - C = O) ν_8
977	$\nu = 0$
915	ν_s (C - O) + δ (O - C = O) ν_3
854	H_2O rock
807	δ (O - C = O) + ν (V - O) ν_9
540	ν (V - O) + ν (C - C) ν_4
400, 368	ν (V - O) + ring def. ν_{11}
291	

Fujita et al⁵⁵ have studied the spectra of coordinated water in metallic complexes and found that in general, bands in the range $795 - 1012 \text{ cm}^{-1}$ are evidence of coordinated water but exceptions occur where strong hydrogen bonds are present. In the case of AVO no bands were lost on dehydration in this particular range.

A feature which is of special interest is the sharp peak at 977 cm^{-1} due to the vanadyl ion. Barraclough, Lewis and Nyholm⁵⁶ examined the spectra of various complexes containing oxycations of titanium, vanadium, molybdenum, chromium, manganese and rhenium and invariably a band occurred in the range $900 - 1,100\text{ cm}^{-1}$. They concluded that this particular frequency has an important diagnostic value in the study of metal oxo-complexes.

Selbin, Holmes and McGlynn^{57,58} confirmed this by an examination of fifty one vanadyl complexes, which showed that in all cases, the $V = O$ stretching frequencies lay within the range $985 \pm 50\text{ cm}^{-1}$. The object of this investigation was to correlate the strength of the attachment of various ligands to the metal atom with changes in the $V = O$ stretching frequency.

2.6 THE ELECTRONIC ABSORPTION SPECTRUM

The absorption spectrum of AVO has been reported by Jorgensen⁵⁹ who found bands at $12,600$, $16,500$ and $29,400\text{ cm}^{-1}$. Golding⁵² found these same bands in the case of potassium vanadyl oxalate and explained them on the assumption that the complex anion has a pyramidal structure. The present work suggests that it is octahedral.

Ballhausen and Gray⁶⁰ have reviewed the available spectral and magnetic evidence concerning the structure of vanadyl ion complexes and concluded that the ion $VO(H_2O)_5^{2+}$ retains intact the VO^{2+} moiety in solution and the latter is surrounded by water molecules to complete a distorted octahedral array. Using this structure as a model, the bonding in the ion was explained in terms of molecular orbital theory. The splitting pattern of the energy levels proposed

by Ballhausen and Gray is given in Fig. 2.1.

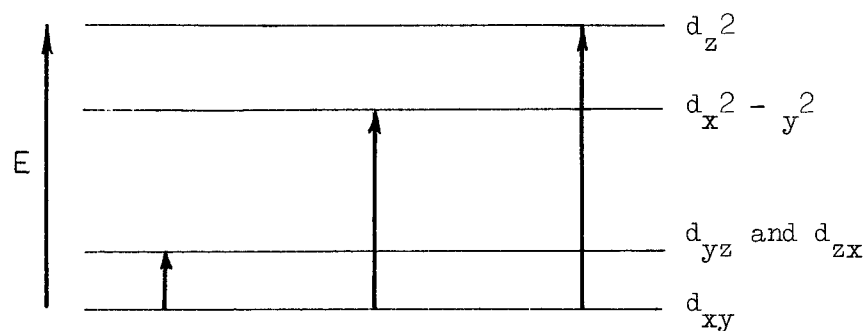

FIG. 2.1

This scheme also accounts for the three bands found in the absorption spectrum of AVO, as follows:

<u>Position of Band</u>	<u>Transition</u>
12,600 cm^{-1}	$d_{xy} \rightarrow d_{yz} \text{ and } d_{zx}$
16,500 cm^{-1}	$d_{xy} \rightarrow d_x^2 - y^2$
29,400 cm^{-1}	$d_{xy} \rightarrow d_z^2$

CHAPTER THREE

CHAPTER III

Structure determination by X-ray analysis - theoretical considerations.

3.1 INTRODUCTION

Crystals are composed of groups of atoms repeated at regular intervals, with the same orientation, in three dimensions. When a group of atoms is represented by a point, the collection of points so formed is termed the space lattice of the crystal and this lattice may be regarded as the repetition in space of a unit cell. Any one set of corresponding atoms in the unit cell lies on a lattice and thus a crystal with N atoms in the unit cell can be regarded as based upon N identical interpenetrating lattices.

Structural analysis involves the measurement of the intensity of the X-rays diffracted by the atoms. The problem is made tractable by a knowledge of the pattern of repetition of the lattice points and also of the symmetry elements operating within the crystal structure. Bravais established that the number of possible space lattices is fourteen and Schoenflies and Fedorov showed that there are only two hundred and thirty different periodic arrangements of symmetry elements in space.

It was demonstrated by Friedrich and Knipping that crystals are capable of diffracting an X-ray beam. W. H. and W. L. Bragg showed that these diffraction effects obeyed the laws of optics and could be used to determine the precise arrangements of atoms and molecules in crystals.

Sets of planes may be drawn through the points in the lattice and these planes may be referred to three axes in the crystal. Bragg showed

that cooperative reflection of an X-ray beam can only occur when the following relationship holds,

$$n\lambda = 2d \sin\theta$$

where n is an integer,

λ is the wavelength of the X-rays,

d is the interplanar spacing,

and θ is the angle between the reflecting plane and the incident beam.

The diffracted beams when recorded photographically are shown as an array of spots. The relative positions of the spots enables the calculation of the unit cell dimensions and also identifies the reflecting plane in terms of its axial intercepts or indices. The relative intensities of the spots gives information concerning the location of the individual atoms within the unit cell. A third aspect of the photographic record is that it may indicate the presence or absence of certain symmetry elements in the crystal and this is important in establishing its space group.

3.2 THE RECIPROCAL LATTICE

The unit cell exists in real or direct space but it is convenient to consider it and the lattice which it generates in terms of reciprocal space. AVO is monoclinic and in direct space the unit cell may be represented as in Fig. 3.1.

The geometric relationships between the direct cell and the reciprocal cell (asterisked quantities) are as follows.

$$\begin{aligned} a^* &= \frac{1}{a \sin\beta} & a &= \frac{1}{a^* \sin\beta^*} & b^* &= \frac{1}{b} & b &= \frac{1}{b^*} \\ c^* &= \frac{1}{c \sin\beta} & c &= \frac{1}{c^* \sin\beta^*} \end{aligned}$$

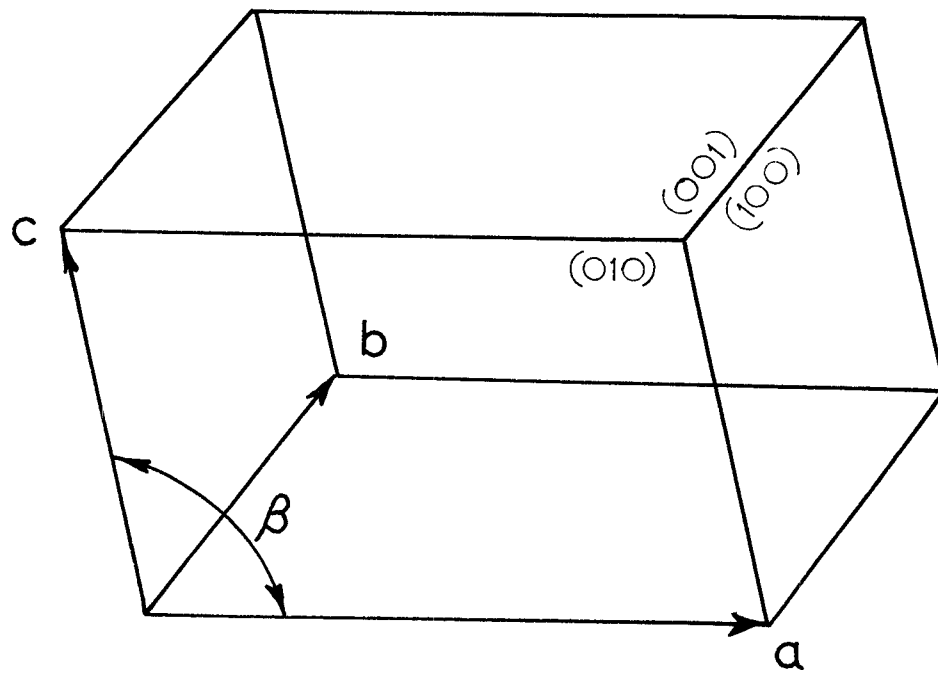

FIG. 3.1

$$\alpha = \gamma = \alpha^* = \gamma^* = 90^\circ \quad \beta^* = 180^\circ - \beta.$$

It can be shown that any lattice in direct space has a derivative reciprocal lattice orthogonal to it.

Consider a crystal in a beam of X-rays of wavelength λ and assume that the beam lies in the $a^* c^*$ plane of the reciprocal lattice which has its origin at O. See Fig. 3 (2)

The circle POB centred on C is drawn with radius $1/\lambda$ so that O falls on its circumference.

Suppose that P is a reciprocal lattice point which lies on the circumference of the circle then $\sin \theta = \frac{OP}{OB} = \frac{OP}{2/\lambda}$

Since P is a r. l. point the length of OP is equal to $\frac{1}{d_{hkl}}$ where d is the perpendicular distance separating planes having indices hkl.

$$\text{Hence } \sin \theta = \frac{1 \cdot \lambda}{2d_{hkl}}$$

$$\text{i.e. } 1 \cdot \lambda = 2d \sin \theta .$$

Thus Bragg's equation may be expressed in terms of the reciprocal lattice and the fundamental condition for a reflection to occur is that a r.l. point must lie on the surface of a sphere constructed in accordance with these defined conditions.

As the crystal rotates about a crystallographic axis, the r.l. points cut through the sphere of reflection and the diffracted beams are recorded on film or by a counter. From a knowledge of the geometry of the instrument, it is possible to relate these diffracted beams to specific points in the r.l.

It is not necessary to record and index all possible reflections which may be available within the limiting sphere since duplication

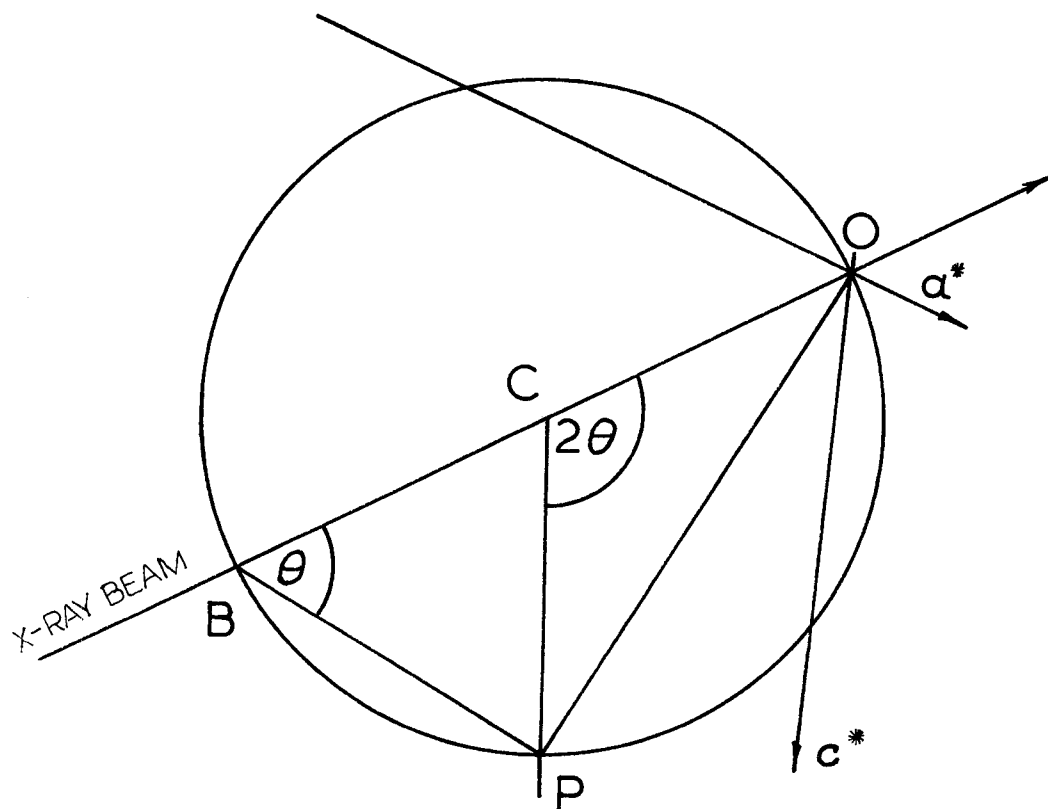

FIG. 3.2

occurs due to symmetry. Consider the relationships between the intensities of the reflections for a monoclinic crystal. First of all it may be stated that because of Friedel's Law certain identities hold in all crystal systems. In addition, in monoclinic systems, rotation about the two fold axis parallel to b^* or reflection across the mirror plane a^*c^* generate equivalent positions. This may be summarised as follows:

	<u>Friedel's Law</u>	<u>Rotation</u>	<u>Reflection</u>			
I_{hkl}	\equiv	$I_{\bar{h}\bar{k}\bar{l}}$	\equiv	$I_{\bar{h}k\bar{l}}$	\equiv	$I_{h\bar{k}l}$
$I_{\bar{h}kl}$	\equiv	$I_{h\bar{k}\bar{l}}$	\equiv	I_{hkl}	\equiv	$I_{\bar{h}\bar{k}l}$
		I_{hkl}	\neq	$I_{\bar{h}kl}$		

It is therefore only necessary to measure reflections due to r.l. points within that part of the sphere bounded by planes formed by certain of the principal r.l. axes. In the present work, the indices chosen were hkl and $h\bar{k}\bar{l}$.

3.3 THE STRUCTURE FACTOR

The object in measuring the intensities of reflections is to calculate a quantity known as the structure factor. The intensity value of a given reflection hkl is related to the amplitude of the structure factor by the expression,

$$I_{\text{obs}} = K |F|^2 (Lp) (A) \quad 3.2$$

where F is the structure amplitude, Lp (Lorentz and polarisation) are factors which are independent of the structural arrangement and A is a term which allows for absorption within the crystal.

The structure factor F is a vector quantity defined by an amplitude and phase. Of these two quantities only the amplitude can

be measured, the phase cannot be determined experimentally.

The magnitude of the resultant vector may be expressed in terms of the projections of its various components on orthogonal axes. Thus

$$|F| = \left[\left(\sum_j f_j \cos \delta_j \right)^2 + \left(\sum_j f_j \sin \delta_j \right)^2 \right]^{\frac{1}{2}} \quad 3.3$$

and the phase angle is given by

$$\alpha = \tan^{-1} \left[\frac{f_j \sin \delta_j}{f_j \cos \delta_j} \right] \quad 3.4$$

where f is the scattering factor of the j atoms and δ is the angle between the j vectors and the real axis.

Now Bragg's Law states that there is a phase difference of 2π radians between waves from successive planes in any set having indices (hkl) and it follows that the phase difference for unit translations along the axis of the unit cell are $2\pi h$, $2\pi k$ and $2\pi l$. If x , y and z are the fractional coordinates of an atom with respect to the unit cell edges, then the phase difference between a wave at the origin of the unit cell and the point where the atom is located, is given by,

$$\delta = 2\pi(hx + ky + lz) \quad 3.5$$

Substitution in 3.3 gives a general expression for the structure amplitude.

$$|F_{hkl}| = \left\{ \left[\sum_j f_j \cos 2\pi(hx_j + ky_j + lz_j) \right]^2 + \left[\sum_j f_j \sin 2\pi(hx_j + ky_j + lz_j) \right]^2 \right\}^{\frac{1}{2}} \quad 3.6$$

This expression is of the form,

$$|F_{hkl}| = (A_{hkl}^2 + B_{hkl}^2)^{\frac{1}{2}} \quad 3.7$$

where the phase angle of the resultant is given by,

$$\alpha_{hkl} = \tan^{-1} \left[\frac{B_{hkl}}{A_{hkl}} \right] \quad 3.8$$

These equations relate the structure amplitudes to the relative positions of the atoms in the cell, in terms of their coordinates. It is also implied that if we have a structure where the positions of the atoms are known or assumed, we can calculate a set of structure amplitudes and phase angles.

One method of solving structures is to postulate a probable atomic arrangement and then calculate a set of structure amplitudes and phases and thus obtain the structure factors (F_{calc}). The calculated phase angles are then combined with the observed structure amplitudes to give the observed structure factors (F_{obs}). Variations in the atomic coordinates are then made until F_{obs} and F_{calc} are brought into satisfactory agreement.

The structure factor can also be treated as a complex number.

$$F = A + iB \quad 3.9$$

where A is the projection on the real axis and B is the projection on the imaginary axis. This leads to the exponential form of the structure factor,

$$F = \sum_j f_j \exp 2\pi i (hx_j + ky_j + lz_j) \quad 3.10$$

If the space group is centrosymmetric and the origin of the coordinates is placed at that centre, an important simplification of the calculation results. In this case, the projections on the imaginary axis will cancel out and in consequence the B terms will disappear. The resultant therefore lies on the real axis and the phase angle can only have values of 0 or π , according to whether the cosine terms sum to a positive or negative quantity with respect to

the origin. This results in the structure factors having a positive or negative sign.

3.4 SPECIAL FORMS OF THE STRUCTURE FACTOR

The fact that many space groups possess elements of symmetry can lead to special forms of the structure factor. This may be illustrated for the case of $P2_1/c$, to which group AVO belongs.

The structure factor for the general case calculates over all atoms in the cell but these may be regarded as comprising n unique atoms in an asymmetric unit, arranged in m symmetry related groups. We then write 3.10 in the form,

$$F_{hkl} = \sum_n f_n \left[\sum_m \exp 2\pi i (hx_{m,n} + ky_{m,n} + lz_{m,n}) \right] \quad 3.11$$

which for convenience may be expressed,

$$F_{hkl} = \sum_n f_n (T_{hkl})_n \quad 3.12$$

The space group $P2_1/c$ has four equivalent positions.

(a) x, y, z (b) $\bar{x}, \bar{y}, \bar{z}$ (c) $\bar{x}, \frac{1}{2} + y, \frac{1}{2} - z$, (d) $x, \frac{1}{2} - y, \frac{1}{2} + z$.

Both a, b and c, d are centrosymmetrically related pairs and the positions a, c are related by the twofold screw axis.

Using T_{hkl} in its trigonometrical form we have for the centrosymmetrically related pairs,

$$T_{hkl} = \cos 2\pi (hx + ky + lz) + i \sin 2\pi (hx + ky + lz) \\ + \cos 2\pi (-hx - ky - lz) + i \sin 2\pi (-hx - ky - lz)$$

$$\text{i.e. } T_{hkl} = 2 \cos 2\pi (hx + ky + lz)$$

Similarly for the a and c asymmetric units we obtain

$$T_{hkl} = 2 \cos 2\pi (-hx + ky + \frac{k}{2} + \frac{1}{2} - lz)$$

Hence the total contribution for all atoms reduces to

$$T_{hkl} = 2 \left[\cos 2\pi (hx + ky + lz) + \cos 2\pi (-hx + ky + \frac{k}{2} + \frac{1}{2} - lz) \right] \quad 3.13$$

Further simplification can be achieved by taking advantage of the fact that when $k + l$ is even, the sine terms in the expanded form of 3.13 become zero and

$$T_{hkl} = 4 \cos 2\pi(hx + lz) \cos 2\pi ky \quad 3.14$$

also when $k + l$ is odd, the cosine terms are zero

$$\text{hence } T_{hkl} = -4 \sin 2\pi(hx + lz) \sin 2\pi ky \quad 3.15$$

Where one of the indices is zero these relationships are of special significance. Consider the case of reflections having indices $h0l$.

When $k + l$ is even,

$$T_{hkl} = 4 \cos 2\pi(hx + lz)$$

and when $k + l$ is odd,

$$T_{hkl} = 0$$

T_{hkl} is also zero when h and l are zero and k is odd. In other words systematic absences occur in the following cases:

$0k0$ when k is odd

$h0l$ when l is odd

The first condition corresponds to the absences due to a 2 fold screw axis parallel to b and the second to a glide plane perpendicular to c . The space group $P2_1/c$ is in fact uniquely identified by these systematic absences.

3.5 THE APPLICATION OF FOURIER METHODS

An important aspect of the analysis is the calculation of the electron density distribution throughout the unit cell. Since the crystal is periodic in three dimensions the distribution of electron density can be computed by a triple Fourier series.

$$\rho_{x,y,z} = \sum_h \sum_k \sum_l C_{hkl} \exp 2\pi i (h'x + k'y + l'z) \quad 3.16$$

where h', k', l' are integers between $-\infty$ and $+\infty$ and the coefficients of the Fourier series are related to the structure factor by the expression,

$$F_{hkl} = C_{hkl} \cdot V \quad 3.17$$

where V is the volume of the unit cell,

Hence,

$$\rho_{(x,y,z)} = \frac{1}{V} \sum_h \sum_k \sum_l F_{hkl} \exp - 2\pi i (hx + ky + lz) \quad 3.18$$

Application of this Fourier series permits the calculation of electron density at a large number of points within the unit cell. The positions of the atoms are then revealed as peaks in the derived Fourier map.

3.6 THE PHASE PROBLEM

Measurement of the observed intensities of reflections can give direct information concerning the amplitude of the scattered wave but not its phase. Because of this many structures have been solved by trial and error methods. At present the indirect method using the heavy atom technique is widely employed but direct methods which permit the phases to be deduced from the structure amplitudes have now been established. The heavy atom procedure was applied to AVO and the present discussion will be confined to this.

3.7 THE PATTERSON FUNCTION

A. L. Patterson made the important observation that if the squares of the structure amplitudes are used as the coefficients in a Fourier series, the resulting synthesis reveals the vectors between the atoms.

The Patterson function may be written,

$$P_{u,v,w} = \frac{1}{V} \sum \sum \sum_{-\infty}^{\infty} |F_{hkl}|^2 \cos 2\pi(hu + kv + lw) \quad 3.19$$

In general, a peak in the Patterson map having coordinates (u,v,w) , indicates that there are atoms in the unit cell at points (x_1, y_1, z_1) and (x_2, y_2, z_2) having the following relationship:

$$u = x_1 - x_2$$

$$v = y_1 - y_2$$

$$w = z_1 - z_2$$

Patterson space symmetry differs from that in direct space in that translational parts of symmetry elements are absent and a centre of symmetry must be added if not already present. The space group $P2_1/c$ becomes $P2/m$ in Patterson space.

The peak values are related to the products of the atomic numbers of the contributing atoms and this enables the position of a heavy atom to be readily distinguished.

A significant development of Patterson's method is due to Harker who pointed out that as a result of symmetry, vector peaks are concentrated at certain locations in the map, which are now referred to as Harker lines and planes. For example, a mirror plane perpendicular to the b axis and passing through the origin generates an atom at (x, \bar{y}, z) from an atom at (x, y, z) . The corresponding peak will be situated on the Harker line and will have the coordinates $(0, 2y, 0)$. Thus the y value is immediately obtained and this is applied to other Harker planes to deduce the x and z coordinates.

3.8 THE HEAVY ATOM METHOD

When a molecule includes an atom whose atomic number is considerably greater than that of the others, its greater scattering

power is the dominant factor in determining the resultant phase angle. For this reason a Fourier map based on the observed structure amplitudes and the phase angles calculated from the heavy atom position, will contain peaks related to the remaining atoms. Further Fourier syntheses may then be carried out incorporating these additional coordinates, until all of the atom positions have been found.

CHAPTER FOUR

CHAPTER IVTHE DETERMINATION OF THE STRUCTURE OF AVO4.1 INTRODUCTION

The structure of AVO was established by sets of data which were collected in two different ways. The first involved photographic methods of recording reflections and an integrating micro-densitometer for the intensity measurements. This procedure gave the positions of only the non-hydrogen atoms and in view of the importance of hydrogen bonding in such compounds, it was felt that a comprehensive analysis by more accurate techniques would be desirable. The data was therefore collected on an automatic diffractometer and the subsequent discussion of the structure is based entirely on the results which accrued from this method.

The purpose of the present chapter is to record the procedures involved in these structure determinations.

4.2 THE PHOTOGRAPHIC METHOD4.2.1 THE CELL CONSTANTS

The unit cell dimensions were determined by measurement of Weissenburg and precession photographs. The following systematic absences established the space group as $P2_1/c$.

hol absent for l odd

oko absent for k odd

Some relevant constants concerning AVO are collected in Table 4(1).

4.2.2 INTENSITY DATA COLLECTION

A crystal measuring $0.40 \times 0.25 \times 0.08 \text{ mm}^3$ was mounted about the b axis and layers, $h = 0$ to 4 recorded on multiple film packs using the equi-inclination Weissenburg technique. A second crystal of

TABLE 4.1.

AVO CONSTANTS

Formula	$C_4H_{12}O_{11}N_2V$
Molecular Weight	315
Unit Cell Dimensions:	
a	11.162 Å (1)
b	7.919 Å (1)
c	14.370 Å (2)
β	117.450° (5)
Crystal System	Monoclinic
Space Group	$P2_1/c$
Crystal Density ($g \cdot cm^{-3}$)	
calculated	1.76
measured	1.81
Z	4
Linear Absorption Coefficient (cm^{-1})	
(Cu $K\alpha$)	79.94
(Mo $K\alpha$)	9.47
F_{000}	644

dimensions $0.35 \times 0.24 \times 0.08 \text{ mm}^3$ was mounted about the c axis to give layers, $k = 0$ to 8.

Nickel filtered copper radiation ($\lambda = 1.5418 \text{ \AA}$) was used and the reflections were recorded on Ilford Industrial G double coated film.

4.2.3 INDEXING OF REFLECTIONS

Simulated Weissenburg photographs were prepared from charts of the $h0l$ and hkn reciprocal lattice nets. The reflections were indexed by comparison of the simulated and actual photographs.

4.2.4 MEASUREMENT OF INTEGRATED INTENSITIES

In general the intensities were measured on several films and the integrated intensity values were put on a common scale by means of attenuation factors.

4.2.5 DATA REDUCTION

The intensity values for hnl and hkn layers were corrected for Lorentz and polarisation effects. No correction for absorption was made. Interlayer scaling factors were then determined by comparing values for common reflections lying on intersecting lattice layers using the method of Monahan, Schiffer and Schiffer⁶¹.

The structure factors were placed on the same scale and the values for the common reflections were averaged. After eliminating some very weak reflections, a total of 989 independent structure factors was obtained.

4.2.6 STRUCTURE DETERMINATION AND REFINEMENT

The Patterson Solution: The symmetry of the vector set corresponding to $P2_1/c$ is $P2/m$ in which case,

$$A = 4 \cos 2\pi (hx + lz) \cos 2\pi ky$$

and $B = 0$

Therefore the required function has the form,

$$P_{(u,v,w)} = \frac{4}{V} \sum_0^{\infty} \sum_0^{\infty} \sum_{-\infty}^{\infty} \left\{ |F_s(hkl)|^2 \right. \\ \left. (\cos 2\pi hu. \cos 2\pi kv. \cos 2\pi lw - \sin 2\pi hu. \cos 2\pi kv. \right. \\ \left. \sin 2\pi lw) \right\}$$

$P_{(u,v,w)}$ was calculated over one quarter of the unit cell volume and to sharpen the peaks in the map F_{obs} were weighted so that,

$$F_s(hkl) = F_{\text{obs}}(hkl) \exp(B \sin^2 \theta / \lambda^2)$$

where B is an overall isotropic temperature factor arbitrarily set equal to 4.0 \AA^2 .

The four equivalent positions in $P2_1/c$ are,

$$(1) x, y, z \quad (2) \bar{x}, \bar{y}, \bar{z} \quad (3) \bar{x}, \frac{1}{2} + y, \frac{1}{2} - z \quad (4) x, \frac{1}{2} - y, \frac{1}{2} + z.$$

By subtraction from one term of the remaining three, the following independent sets of vectors are obtained.

Set A:	2x	2y	2z
	2x	$-\frac{1}{2}$	$2z - \frac{1}{2}$
	0	$2y - \frac{1}{2}$	$-\frac{1}{2}$
Set B:	-2x	-2y	-2z
	-2x	$-\frac{1}{2}$	$-\frac{1}{2} - 2z$
	0	$-\frac{1}{2} - 2y$	$-\frac{1}{2}$
Set C:	-2x	2y	-2z
	-2x	$\frac{1}{2}$	$\frac{1}{2} - 2z$
	0	$\frac{1}{2} + 2y$	$\frac{1}{2}$
Set D:	2x	-2y	2z
	2x	$\frac{1}{2}$	$\frac{1}{2} + 2z$
	0	$\frac{1}{2} - 2y$	$\frac{1}{2}$

The first row in each case is due to atoms related by a centre of symmetry, the second by the screw axes and the third by two glide

planes. Within these sets are the following relationships,

$$A_{\text{screw}} \equiv D_{\text{screw}} \quad \text{and} \quad B_{\text{screw}} \equiv C_{\text{screw}}$$

$$A_{\text{glide}} \equiv C_{\text{glide}} \quad \text{and} \quad B_{\text{glide}} \equiv D_{\text{glide}}$$

Hence the entire cell would contain (neglecting the origin peaks) twelve peaks due to the vanadium atom as follows.

Four single weight peaks due to atoms related by a centre of symmetry.

Two double weight peaks due to the screw axis.

Two double weight peaks due to the glide plane.

Inspection of these sets shows that there is a Harker Line at $P(0, v, \frac{1}{2})$ and a Harker section at $P(u, \frac{1}{2}, w)$. Peaks were found in the map with the following coordinates.

<u>x/a</u>	<u>y/b</u>	<u>z/c</u>
0	0.429	0.5
0.36	0.5	0.14
0.36	0.071	0.64

Applying set A, the unit cell coordinates of the vanadium atom were obtained as,

<u>x/a</u>	<u>y/b</u>	<u>z/c</u>
0.18	0.035	0.32

An initial structure factor calculation based on these coordinates gave a residual (R) of 0.57. Atomic scattering factors for this calculation were obtained from VOL.III of International Tables for X-Ray Crystallography (1962).

A Fourier synthesis using the signs determined by the first

structure factor calculation, was summed over one quarter of the unit cell volume. The map indicated fourteen possible atomic positions. A model was constructed showing the position of the vanadium atom and its six nearest peaks. These had an octahedral disposition and were attributed to oxygen atoms. Inclusion of these six atoms in a further structure factor calculation reduced R to 0.53.

A new Fourier map revealed the positions of more atoms in the oxalato groups and a subsequent calculation reduced R to 0.40. A difference Fourier map based on the twelve atoms now located, indicated sites for the remaining non-hydrogen atoms. Five cycles of isotropic refinement of the atomic coordinates gave an R factor of 0.19 and four further cycles of anisotropic refinement reduced it to 0.14. Application of three cycles of full matrix refinement gave a final R factor of 0.12.

A difference Fourier map failed to reveal any peaks which could be attributed to hydrogen atoms.

The atomic coordinates and thermal parameters are given in Tables 4.2 and 4.3.

4.3 THE COUNTER METHOD

4.3.1 OPERATING PRINCIPLES OF THE DIFFRACTOMETER

When an incident X-ray beam is reflected from a set of planes (Fig.4.1) the angle θ may be defined by the magnitude of the vector d^* , which is related to the reciprocal of the interplanar spacing, in accordance with Bragg's equation.

$$\sin \theta = \frac{\lambda}{2d} = \frac{\lambda d^*}{2}$$

Two further conditions obtain when reflection occurs.

TABLE 4.2

AVO, NON-HYDROGEN ATOMIC POSITIONAL PARAMETERS ($\times 10^5$)(PHOTOGRAPHIC DATA)

ATOM	x/a	y/b	z/c
V	82461	53832	18208
O(1)	83519	36582	12783
O(2)	93850	67905	13296
O(3)	98651	49309	31973
O(4)	111858	57908	48634
O(5)	92989	84227	44414
O(6)	84289	76170	27748
O(7)	65827	64999	8162
O(8)	45105	71083	5666
O(9)	48444	45939	19981
O(10)	70147	45799	23709
O(11)	30470	55743	34553
N(1)	23559	64536	11873
N(2)	61472	91487	92778
C(1)	101970	59487	39792
C(2)	92218	74237	37157
C(3)	55805	64079	9675
C(4)	58028	49769	18543

TABLE 4.3

AVO, NON-HYDROGEN ATOMIC ANISOTROPIC TEMPERATURE FACTORS ($\times 10^5$)
(PHOTOGRAPHIC DATA)

ATOM	b_{11}	b_{22}	b_{33}	b_{23}	b_{13}	b_{12}
V	514	412	224	-35	322	-41
O(1)	699	553	546	-1395	549	198
O(2)	1069	434	395	74	676	-409
O(3)	544	490	184	-823	20	220
O(4)	442	873	225	56	-162	-104
O(5)	1175	855	303	-173	658	70
O(6)	670	720	174	177	78	453
O(7)	546	473	193	337	124	-158
O(8)	877	1154	441	568	555	186
O(9)	590	2317	604	743	571	656
O(10)	471	1378	312	329	148	-166
O(11)	855	-101	317	-279	448	-429
N(1)	463	893	542	-91	442	296
N(2)	1834	2165	522	132	742	663
C(1)	370	345	663	552	621	-476
C(2)	361	418	260	231	312	741
C(3)	524	642	180	82	-66	-56
C(4)	400	1433	182	-129	290	-491

(a) the vector d^* must lie in the plane of S_0 and S (the diffracting plane).

(b) the direction of d^* bisects the angle between S_0 and S .

In the Hilger and Watts four circle diffractometer, the diffracting plane is coincident with the equatorial plane of the instrument (Fig.4.2). By means of two independently controlled circles (ϕ and χ), the vector d^* may be brought into the plane of the χ circle and also into the equatorial plane. When the θ circle is set at the Bragg angle then the ω circle will bisect the angle between the incident and reflected beams and ω will be equal to θ .

In the reflecting position the vector d^* lies in two mutually perpendicular planes, that of the χ circle bisecting the incident and diffracted beams and that of the plane of diffraction. Under these conditions, there will be specific values of the angles χ and ϕ for reflection to occur.

Given accurate cell constants the positions of the four circles may be calculated for each reflection and the instrument programmed for the automatic collection of intensity data over a specified volume of the reciprocal lattice.

4.3.2 MEASUREMENT OF UNIT CELL DIMENSIONS

A crystal measuring $0.4 \times 0.3 \times 0.08 \text{ mm}^3$ was mounted on the diffractometer. The four circle parameters for the 3, 0, 0 and 0, 0, 2 reflections were found and this information, together with the unit cell dimensions obtained previously, gave a preliminary orientation matrix. This enabled reflections at higher values of θ to be located and a final matrix, together with the unit cell

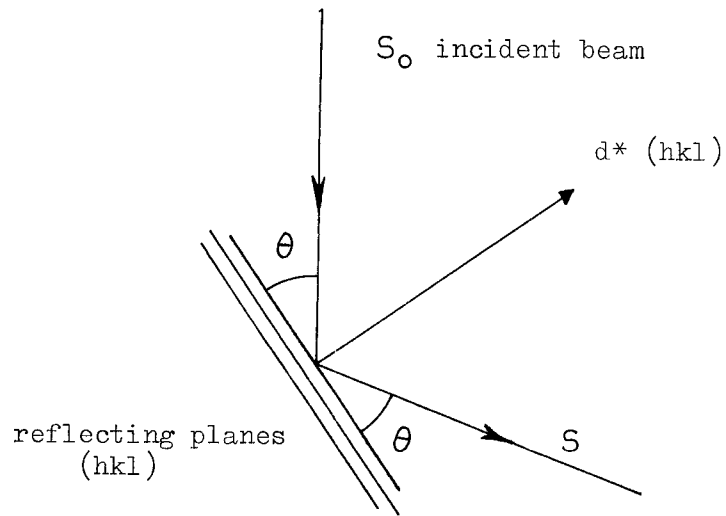

FIG. 4.1

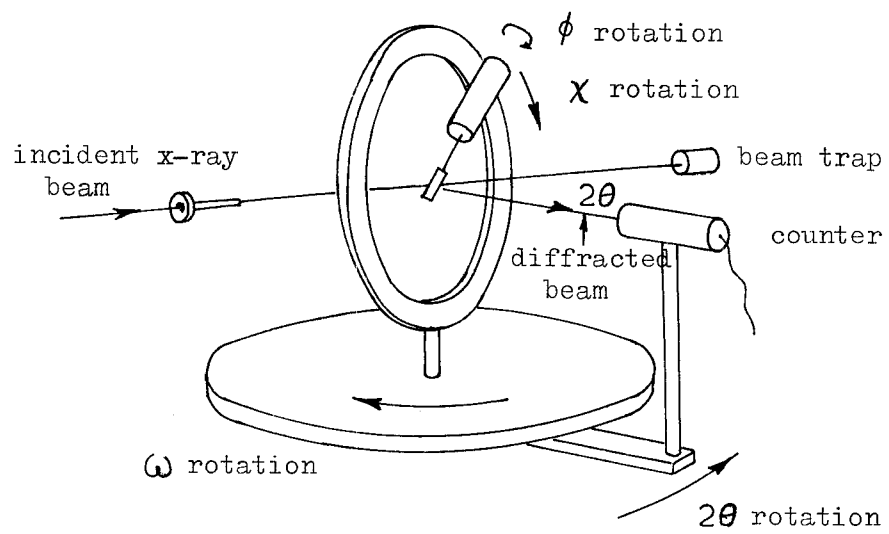

FIG. 4.2

dimensions in Table 4.1, were obtained by a least squares treatment of the parameters of twelve high-order reflections ($M\alpha_1, \lambda = 0.70926 \text{ \AA}$).

4.3.3 INTENSITY DATA COLLECTION

The data was collected using the $\theta, 2\theta$ scan method, with each scan consisting of 75 steps of 0.01° . The counting time for each step was 2 secs and the counting time for both backgrounds was 25 secs. Zr filtered Mo radiation was used.

The intensity sets $h, k \pm 1$ and $-h, k \pm 1$ were collected out to a value of $\theta = 26^\circ$. Three standard reflections were measured at intervals of 50 normal reflections and the circles were driven to reference points at the same intervals.

4.3.4 DATA REDUCTION

The data for equivalent reflections was averaged and then corrected for Lorentz and polarisation factors. No correction was made for absorption.

The standard deviation for the net count, based on counting statistics, is given by,

$$\sigma = \left\{ \frac{S + K^2 (B_1 + B_2)}{n} \right\}^{\frac{1}{2}} \quad 4.1$$

Where S is the peak count, B_1 and B_2 are the measured background counts, K is the ratio of the time taken for the peak measurement to that taken for the measurement of the two backgrounds; n is the number of observations.

It was considered that if the net count was less than 3σ it should be treated as unobserved. Of the total of 2,218 independent reflections measured, 1,413 were regarded as observed and used in the calculations.

4.3.5 STRUCTURE DETERMINATION AND REFINEMENT

The atomic coordinates obtained by the photographic method (Table 4.2), together with the new amplitudes given by the counter procedure, were used to calculate a set of structure factors.

Two cycles of block diagonal least squares refinement with isotropic temperature factors gave an R factor of 0.084. A further cycle of anisotropic refinement reduced it to 0.054.

At this point a difference Fourier map indicated the sites of the twelve hydrogen atoms. Positions for the hydrogen atoms were chosen from the map which were consistent with accepted bond lengths and angles. The coordinates for these atoms were included in the subsequent calculations but were not refined.

Full matrix refinement was now applied, using anisotropic temperature factors for the heavy atoms and assigning an arbitrary isotropic temperature factor of 5.0 to the hydrogens. This gave an R factor of 0.041 and three subsequent cycles gave a final value of 0.039. A difference Fourier map based on the final atomic coordinates showed that no significant electron density remained.

As previously, the form factors for the non-hydrogen atoms were obtained from International Tables, the correction being applied for anomalous dispersion (Mo radiation), in the case of the vanadium atom. The form factor used for the hydrogen atom was that given by Davidson, Simpson and Stewart⁷⁴.

In the last cycle of refinement, the parameter shifts were all less than one-third of the corresponding e.s.d. The weighting scheme was of the form,

$$\sqrt{W} = \frac{2N}{F_o \left\{ S + K^2 (B_1 + B_2) + (P.N)^2 \right\}^{\frac{1}{2}}} \quad 4.2$$

where N is the net count and P was assigned a value of 0.06.

The unobserved reflections were given zero weight in the refinement.

In equation 4.2, the standard deviation in the net count is considered to be,

$$\sigma(N) = \left\{ S + K^2 (B_1 + B_2) + P \cdot N \right\} \quad 4.3$$

$$\text{so that } \sigma(F_o) = \frac{F_o \sigma_N}{2N} \quad 4.4$$

This expression combined with the relation,

$$\sqrt{W} = \frac{1}{\sigma(F_o)} \quad 4.5$$

leads to equation 4.2.

An analysis of the weighting scheme is given below.

TABLE 4.4

AVO, AGREEMENT ANALYSIS

F_o RANGES	N	$W \Delta^2 / N$	R
4 - 8	33	0.26	0.113
8 - 12	219	0.27	0.117
12 - 16	272	0.20	0.071
16 - 20	208	0.22	0.043
20 - 27	266	0.17	0.028
27 - 40	229	0.25	0.024
40 - 140	186	0.27	0.023

4.3.6 ATOMIC PARAMETERS

The final coordinates of the atoms are given in Tables 4.5 and 4.6. The anisotropic temperature factors of the non-hydrogen atoms are listed in Table 4.7.

4.3.7 STRUCTURE FACTORS

The observed and calculated structure factors are given in Table 4.8.

TABLE 4.5AVO, NON-HYDROGEN ATOMIC POSITIONAL PARAMETERS ($\times 10^5$)(COUNTER DATA)

ATOM	x/a	y/b	z/c
V	32512	3772	18203
O(1)	33540	-13294	12734
O(2)	43742	17816	13262
O(3)	48834	- 611	32140
O(4)	61444	7504	48641
O(5)	42806	34141	44282
O(6)	34258	26157	27621
O(7)	15663	14925	7904
O(8)	- 4923	21323	5650
O(9)	- 1580	- 4401	19959
O(10)	20026	- 4517	23725
O(11)	-19010	5599	34851
N(1)	-26543	14369	11804
N(2)	11098	8375	42888
C(1)	51829	9389	39925
C(2)	42237	24668	37245
C(3)	5622	13474	9899
C(4)	7797	249	18475

TABLE 4.6

AVO, HYDROGEN ATOMIC POSITIONAL PARAMETERS ($\times 10^3$)(COUNTER DATA)

<u>ATOM</u>	x/a	y/b	z/c
H(1)	-324	233	75
H(2)	-309	51	105
H(3)	-235	184	179
H(4)	-193	132	105
H(5)	33	55	400
H(6)	115	165	390
H(7)	175	15	440
H(8)	124	140	490
H(9)	-250	130	350
H(10)	-250	- 20	310
H(11)	443	170	78
H(12)	450	290	145

TABLE 4.7

AVO, NON-HYDROGEN ATOMIC ANISOTROPIC TEMPERATURE FACTORS ($\times 10^5$)

(COUNTER DATA)

ATOM	b_{11}	b_{22}	b_{33}	b_{23}	b_{13}	b_{12}
V	615	598	251	-36	366	7
O(1)	780	867	441	-373	478	-35
O(2)	1249	972	407	-385	1040	-711
O(3)	674	722	295	-86	338	253
O(4)	650	870	294	70	188	-39
O(5)	1094	970	296	-282	611	360
O(6)	718	790	235	-1	236	336
O(7)	712	900	253	292	317	203
O(8)	704	1454	583	450	273	466
O(9)	794	2584	733	1135	959	511
O(10)	607	1061	329	461	388	260
O(11)	1050	1154	723	-456	665	-265
N(1)	651	957	400	31	407	-45
N(2)	1224	1899	543	-614	667	245
C(1)	513	637	359	122	503	-158
C(2)	570	665	330	43	437	-47
C(3)	716	759	282	-174	195	55
C(4)	625	1151	321	-63	395	64

TABLE 4.8

STRUCTURE FACTORS

H	K	L	FO	FC	H	K	L	FO	FC	H	K	L	FO	FC	H	K	L	FO	FC
0	0	2	58.1	-56.0	6	0	8	24.2	-24.0	1	1	-9	16.3	-17.1	4	1	-9	9.0	-8.1
0	0	4	87.6	-90.6	6	0	10	-2.8	1.0	1	1	-8	14.5	15.3	4	1	-8	12.0	11.0
0	0	6	17.5	17.6	7	0	-16	-0.5	-3.7	1	1	-7	11.4	12.2	4	1	-7	66.1	65.4
0	0	8	42.7	-43.2	7	0	-14	14.5	14.4	1	1	-6	42.3	39.3	4	1	-6	20.4	-20.3
0	0	10	17.5	17.9	7	0	-12	-6.6	-3.6	1	1	-5	35.6	32.7	4	1	-5	56.8	-56.7
0	0	12	8.9	9.0	7	0	-10	34.3	-34.5	1	1	-4	53.5	50.1	4	1	-4	44.4	-41.2
0	0	14	19.3	-18.7	7	0	-8	-0.4	3.0	1	1	-3	36.5	-34.1	4	1	-3	77.3	76.0
1	0	-16	14.4	-14.7	7	0	-6	42.1	-43.0	1	1	-2	61.7	57.6	4	1	-2	81.6	82.7
1	0	-14	17.2	15.2	7	0	-4	44.6	-47.1	1	1	-1	101.2	102.8	4	1	-1	55.9	57.7
1	0	-12	36.6	37.5	7	0	-2	86.3	89.6	1	1	0	28.4	-27.8	4	1	0	32.2	31.5
1	0	-10	34.5	-33.8	7	0	0	21.5	-21.1	1	1	1	69.4	-70.1	4	1	1	47.3	-47.7
1	0	-8	-1.6	4.6	7	0	2	23.3	-23.1	1	1	2	29.0	-26.9	4	1	2	28.5	27.5
1	0	-6	58.4	-55.0	7	0	4	9.9	7.3	1	1	3	29.2	27.4	4	1	3	24.7	25.2
1	0	-4	59.2	-60.7	7	0	6	-5.2	3.9	1	1	4	72.1	-68.2	4	1	4	33.0	-33.1
1	0	-2	101.4	100.6	7	0	8	-5.2	5.0	1	1	5	28.9	26.6	4	1	5	35.5	35.8
1	0	0	64.1	-66.6	8	0	-16	-8.2	-7.2	1	1	6	-1.8	-1.3	4	1	6	9.9	-10.0
1	0	2	64.7	-60.0	8	0	-14	38.1	37.3	1	1	7	32.2	-32.0	4	1	7	33.8	-33.4
1	0	4	106.9	110.1	8	0	-12	17.8	-18.5	1	1	8	37.8	37.1	4	1	8	8.3	2.4
1	0	6	58.0	-59.5	8	0	-10	21.7	22.5	1	1	9	50.8	51.2	4	1	9	35.6	35.9
1	0	8	41.4	-40.5	8	0	-8	-0.4	6.4	1	1	10	8.1	-9.2	4	1	10	25.9	-26.1
1	0	10	24.5	25.4	8	0	-6	-4.3	-5.7	1	1	11	19.8	19.7	4	1	11	16.8	-15.5
1	0	12	20.2	-20.1	8	0	-4	47.7	46.9	1	1	12	-0.5	0.4	4	1	12	-0.5	-5.3
1	0	14	-2.9	4.5	8	0	-2	10.8	-10.9	1	1	13	12.3	-14.3	5	1	-17	14.4	-13.9
2	0	-16	-2.9	-5.4	8	0	0	40.4	-41.2	1	1	14	-1.2	-3.5	5	1	-16	-2.2	-2.2
2	0	-14	20.8	20.2	8	0	2	41.6	42.0	1	1	15	11.5	11.8	5	1	-15	19.5	18.4
2	0	-12	48.2	-48.3	8	0	4	-0.5	-5.6	2	1	-16	-1.4	6.5	5	1	-14	-0.5	2.0
2	0	-10	21.1	21.2	8	0	6	-6.4	-7.0	2	1	-15	30.4	30.6	5	1	-13	12.1	11.7
2	0	-8	66.4	-63.1	8	0	8	16.7	15.9	2	1	-14	-6.0	4.4	5	1	-12	8.5	9.3
2	0	-6	14.1	-15.9	9	0	-16	27.8	25.4	2	1	-13	-6.8	4.0	5	1	-11	21.9	-22.2
2	0	-4	11.0	10.3	9	0	-14	-2.2	-4.0	2	1	-12	29.6	-30.4	5	1	-10	10.3	11.6
2	0	-2	37.4	35.1	9	0	-12	21.2	-21.5	2	1	-11	32.6	-32.8	5	1	-9	46.6	46.8
2	0	0	20.4	20.2	9	0	-10	-6.5	4.8	2	1	-10	7.8	-7.2	5	1	-8	47.4	-45.9
2	0	2	80.5	82.9	9	0	-8	22.4	-21.2	2	1	-9	11.8	11.3	5	1	-7	68.2	-67.1
2	0	4	30.6	-30.5	9	0	-6	-3.5	-2.6	2	1	-8	-2.2	-2.5	5	1	-6	37.7	-35.6
2	0	6	-4.0	-5.6	9	0	-4	42.1	42.9	2	1	-7	39.8	-39.8	5	1	-5	27.3	-26.3
2	0	8	19.1	19.1	9	0	-2	52.3	-53.3	2	1	-6	9.7	9.8	5	1	-4	47.1	45.1
2	0	10	11.3	-12.1	9	0	0	18.6	16.9	2	1	-5	91.5	89.5	5	1	-3	6.2	6.6
2	0	12	17.9	18.7	9	0	2	13.8	-15.5	2	1	-4	10.3	8.9	5	1	-2	21.2	-21.0
2	0	14	-6.4	-4.7	9	0	4	23.4	-24.1	2	1	-3	79.9	80.5	5	1	-1	52.6	-55.8
3	0	-16	22.8	23.2	9	0	6	20.8	20.7	2	1	-2	58.9	-60.9	5	1	0	14.5	13.6
3	0	-14	12.6	-12.0	10	0	-16	-9.7	-10.6	2	1	-1	58.0	-58.6	5	1	1	23.6	24.6
3	0	-12	11.8	12.8	10	0	-14	15.5	-18.0	2	1	0	36.5	34.3	5	1	2	-4.4	2.1
3	0	-10	57.8	59.7	10	0	-12	29.3	29.4	2	1	1	8.7	8.5	5	1	3	25.8	26.3
3	0	-8	36.2	-36.5	10	0	-10	12.0	-13.9	2	1	2	40.6	-38.9	5	1	4	6.5	7.5
3	0	-6	-0.3	2.1	10	0	-8	14.7	13.9	2	1	3	-2.1	2.2	5	1	5	23.4	-23.7
3	0	-4	18.7	17.7	10	0	-6	10.5	11.9	2	1	4	17.2	15.9	5	1	6	-3.6	-5.1
3	0	-2	56.9	-58.1	10	0	-4	18.0	-17.7	2	1	5	84.7	-83.7	5	1	7	-6.0	-5.7
3	0	0	52.0	51.5	10	0	-2	-3.5	-3.9	2	1	6	7.1	7.4	5	1	8	-7.7	-7.9
3	0	2	34.2	-35.8	10	0	0	-3.6	-2.4	2	1	7	34.7	35.7	5	1	9	-9.4	-6.3
3	0	4	26.2	23.9	10	0	2	12.0	-12.5	2	1	8	9.6	-9.5	5	1	10	-0.5	2.1
3	0	6	75.3	76.9	10	0	4	27.1	25.6	2	1	9	7.8	-6.9	5	1	11	16.0	-14.4
3	0	8	16.7	-16.0	11	0	-14	29.5	30.2	2	1	10	21.7	-22.8	6	1	-17	-2.5	-3.2
3	0	10	11.2	8.5	11	0	-12	26.0	-25.4	2	1	11	15.6	-16.4	6	1	-16	15.7	12.7
3	0	12	24.0	-25.8	11	0	-10	18.5	18.9	2	1	12	-3.4	-1.2	6	1	-15	-0.5	2.3
4	0	-16	23.7	-23.1	11	0	-8	20.9	20.3	2	1	13	10.8	10.4	6	1	-14	-2.7	6.0
4	0	-14	38.6	-39.7	11	0	-6	15.5	-14.8	2	1	14	-5.6	-4.8	6	1	-13	11.6	-8.8
4	0	-12	43.4	43.8	11	0	-4	22.5	21.5	3	1	-17	13.8	16.0	6	1	-12	-5.0	9.1
4	0	-10	45.5	-48.2	11	0	-2	-7.2	-7.7	3	1	-16	15.9	-16.3	6	1	-11	25.0	24.6
4	0	-8	31.5	31.5	11	0	0	19.2	-17.9	3	1	-15	-3.2	-4.0	6	1	-10	53.5	-54.3
4	0	-6	16.1	17.4	11	0	2	11.3	11.2	3	1	-14	-7.9	-9.2	6	1	-9	7.2	5.5
4	0	-4	84.4	-97.1	12	0	-14	13.2	-9.7	3	1	-13	37.9	-38.6	6	1	-8	-2.9	4.3
4	0	-2	28.2	-25.9	12	0	-12	21.9	-21.3	3	1	-12	25.8	26.0	6	1	-7	66.0	-66.7
4	0	0	21.5	-22.0	12	0	-10	21.5	20.7	3	1	-11	45.6	45.8	6	1	-6	25.4	25.3
4	0	2	46.7	-46.9	12	0	-8	-6.3	-6.5	3	1	-10	14.8	-16.2	6	1	-5	60.9	62.5
4	0	4	28.6	29.4	12	0	-6	-0.5	7.5	3	1	-9	46.5	-47.6	6	1	-4	20.4	19.5
4	0	6	8.9	-11.1	12	0	-4	-5.3	-11.0	3	1	-8	-4.4	-4.9	6	1	-3	36.2	-31.1
4	0	8	9.2	-12.1	12	0	-2	30.9	-30.2	3	1	-7	15.7	-15.7	6	1	-2	10.5	10.9
4	0	10	26.2	25.8	12	0	0	18.9	19.3	3	1	-6	28.8	26.3	6	1	-1	7.1	-6.5
4	0	12	31.7	-32.6	13	0	-12	21.6	22.9	3	1	-5	7.1	9.6	6	1	0	28.3	29.6
5	0	-16	-4.1	-7.0	13	0	-10	-0.5	-4.4	3	1	-4	78.5	78.2	6	1	1	24.0	24.5
5	0	-14	53.6	53.8	13	0	-8	-5.5	-4.8	3	1	-3	107.9	-109.1	6	1	2	18.1	18.3
5	0	-12	33.4	-33.4	13	0	-6	17.2	12.2	3	1	-2	7.3	7.8	6	1	3	11.9	-13.5
5	0	-10	-4.6	4.9	13	0	-4	-0.5	1.6	3	1	-1	84.1	91.2	6	1	4	-0.4	-4.7
5	0	-8	28.7	28.2	0	1	1	44.5	41.7	3	1	0	76.5	-80.8	6	1	5	13.3	13.4
5	0	-6	54.7	-54.3	0	1	2	13.9	-14.9	3	1	1	43.7	42.3	6	1	6	-6.1	-5.6
5	0	-4	46.3	47.8	0	1	3	108.2	-108.7	3	1	2	8.1	6.5	6	1	7	14.9	16.4
5	0	-2	-4.9	-47.7	0	1	4	21.9	-21.1	3	1	3	137.7	-136.3	6	1	8	12.8	-12.3
5	0	0	13.7	-14.5	0	1	5	29.3	30.0	3	1	4	33.2	32.7	6	1	9	-9.6	-10.2
5	0	2	72.6	74.1	0	1	6	17.6	16.7	3	1	5	67.6	67.3	6	1	10	-5.1	5.8
5	0	4	20.5	20.4	0	1	7	44.1	-42.6	3	1	6	9.6	9.6	7	1	-17	12.8	11.3
5	0	6	-0.4	-2.8	0	1	8	-2.9	-3.3	3	1	7	-5.6	7.3	7	1	-16	-2.8	4.2
5	0	8	45.3	46.3	0	1	9												

M	K	L	FO	FC	M	K	L	FO	FC	M	K	L	FO	FC	M	K	L	FO	FC
7	1	-1	51.0	52.9	11	1	-1	18.4	-17.1	2	2	4	10.9	-10.6	5	2	7	-1.2	-3.2
7	1	0	9.0	-9.5	11	1	0	15.6	14.5	2	2	5	28.0	27.1	5	2	8	27.7	27.5
7	1	1	22.6	-23.3	11	1	1	-6.0	3.6	2	2	6	27.4	27.0	5	2	9	19.1	-19.4
7	1	2	-2.8	4.8	11	1	2	-0.5	0.2	2	2	7	21.6	21.2	5	2	10	14.7	-11.8
7	1	3	-7.1	8.4	12	1	-14	-0.5	0.6	2	2	8	-1.7	-4.1	5	2	11	-6.9	5.1
7	1	4	-2.9	2.6	12	1	-13	17.8	-16.5	2	2	9	23.2	-23.0	6	2	-17	-0.5	3.8
7	1	5	-7.4	7.6	12	1	-12	14.2	13.2	2	2	10	-6.4	3.9	6	2	-16	25.1	25.3
7	1	6	-0.5	-1.7	12	1	-11	15.7	15.8	2	2	11	-0.5	-0.8	6	2	-15	-0.5	-4.9
7	1	7	15.8	-14.2	12	1	-10	-3.0	-6.4	2	2	12	13.0	11.4	6	2	-14	15.9	-17.1
7	1	8	-6.3	6.7	12	1	-9	-5.0	6.7	2	2	13	-0.5	-2.6	6	2	-13	10.6	12.6
7	1	9	-8.5	5.7	12	1	-8	-0.5	-0.2	2	2	14	-3.7	4.2	6	2	-12	15.8	-17.3
8	1	-17	34.5	-34.8	12	1	-7	20.7	-19.2	3	2	-16	18.3	18.0	6	2	-11	27.7	-29.0
8	1	-16	-7.7	-6.1	12	1	-6	9.8	4.0	3	2	-15	16.3	-15.7	6	2	-10	18.1	18.1
8	1	-15	27.8	27.5	12	1	-5	25.4	24.3	3	2	-14	22.1	-21.6	6	2	-9	43.2	-43.9
8	1	-14	-9.0	-5.4	12	1	-4	-0.5	-8.4	3	2	-13	19.0	19.5	6	2	-8	25.0	-25.3
8	1	-13	-0.5	3.7	12	1	-3	-7.9	-8.8	3	2	-12	-7.7	8.1	6	2	-7	17.8	17.3
8	1	-12	9.7	-11.3	12	1	-2	-0.5	-5.5	3	2	-11	-5.2	7.3	6	2	-6	49.6	50.4
8	1	-11	34.9	-35.4	12	1	-1	-0.5	-2.9	3	2	-10	36.2	36.3	6	2	-5	9.5	8.2
8	1	-10	10.5	9.0	12	1	0	-0.5	-2.2	3	2	-9	27.1	-26.7	6	2	-4	19.2	-19.5
8	1	-9	27.1	26.4	13	1	-12	-8.9	-9.6	3	2	-8	34.1	-33.0	6	2	-3	8.3	-9.0
8	1	-8	-5.1	-4.2	13	1	-11	-5.7	4.9	3	2	-7	31.0	30.5	6	2	-2	16.9	-17.0
8	1	-7	23.2	-22.7	13	1	-10	-0.5	1.1	3	2	-6	69.7	67.5	6	2	-1	-4.5	-3.1
8	1	-6	-0.4	3.5	13	1	-9	22.2	-20.6	3	2	-5	30.7	29.8	6	2	0	55.3	58.2
8	1	-5	11.4	-12.1	13	1	-8	-6.5	5.9	3	2	-4	17.1	14.7	6	2	1	-5.8	-5.3
8	1	-4	17.6	17.5	13	1	-7	17.4	17.1	3	2	-3	45.3	-44.1	6	2	2	28.8	-29.0
8	1	-3	37.2	38.8	13	1	-6	-0.5	-2.5	3	2	-2	8.0	-9.5	6	2	3	-3.5	-4.1
8	1	-2	15.3	-15.9	13	1	-5	-2.5	-5.7	3	2	-1	62.7	-60.8	6	2	4	27.5	-27.9
8	1	-1	65.0	-66.4	13	1	-4	-5.3	-7.6	3	2	0	-2.5	4.1	6	2	5	-1.3	-5.1
8	1	0	-0.4	-1.2	13	1	-3	11.7	-11.0	3	2	1	32.5	-30.9	6	2	6	16.7	17.7
8	1	1	-2.6	4.0	0	2	0	90.5	95.8	3	2	2	-1.7	-1.5	6	2	7	21.8	-21.9
8	1	2	-0.4	-0.2	0	2	1	70.4	-72.6	3	2	3	40.9	39.5	6	2	8	16.9	-16.6
8	1	3	9.5	7.2	0	2	2	95.0	-93.0	3	2	4	31.6	-31.3	6	2	9	-9.6	7.7
8	1	4	12.6	13.1	0	2	3	94.2	-93.5	3	2	5	-5.1	4.2	6	2	10	-8.8	-1.6
8	1	5	24.2	-24.2	0	2	4	20.0	19.4	3	2	6	27.8	28.0	7	2	-17	-2.3	5.5
8	1	6	-7.8	8.7	0	2	5	23.4	23.2	3	2	7	27.9	-27.5	7	2	-16	30.6	-30.9
8	1	7	19.9	19.9	0	2	6	85.4	82.8	3	2	8	30.4	-30.3	7	2	-15	-7.5	7.5
9	1	-17	-7.7	10.1	0	2	7	-3.8	-3.5	3	2	9	10.5	-11.4	7	2	-14	11.2	12.1
9	1	-16	11.5	12.1	0	2	8	53.7	-53.3	3	2	10	13.8	15.1	7	2	-13	-2.1	0.5
9	1	-15	12.1	12.9	0	2	9	21.5	22.0	3	2	11	-4.1	-1.4	7	2	-12	-1.2	-1.7
9	1	-14	-4.6	-3.6	0	2	10	26.7	26.5	3	2	12	-2.8	4.2	7	2	-11	23.0	-24.1
9	1	-13	29.7	-29.3	0	2	11	-4.9	-4.7	3	2	13	-8.1	-8.6	7	2	-10	20.8	-19.8
9	1	-12	-0.5	3.3	0	2	12	29.6	29.6	4	2	-17	13.6	-14.2	7	2	-9	27.9	28.0
9	1	-11	10.8	8.6	0	2	13	20.2	-21.0	4	2	-16	17.3	-16.3	7	2	-8	-2.2	-0.8
9	1	-10	-6.6	-5.8	0	2	14	30.6	-31.6	4	2	-15	-6.3	9.7	7	2	-7	-5.7	-6.7
9	1	-9	-3.6	0.8	0	2	15	-5.3	-1.3	4	2	-14	-0.5	-5.2	7	2	-6	6.9	6.8
9	1	-8	18.5	19.1	1	2	-15	-0.5	2.6	4	2	-13	-0.5	0.6	7	2	-5	-4.2	-4.5
9	1	-7	-1.5	3.1	1	2	-14	15.0	16.0	4	2	-12	23.4	23.0	7	2	-4	-0.4	-4.7
9	1	-6	-5.6	-1.0	1	2	-13	13.1	-13.5	4	2	-11	18.3	-16.3	7	2	-3	31.6	33.6
9	1	-5	39.8	40.1	1	2	-12	10.5	-6.6	4	2	-10	39.2	-38.8	7	2	-2	29.9	31.5
9	1	-4	31.1	-31.7	1	2	-11	43.2	-42.9	4	2	-9	14.3	14.7	7	2	-1	11.3	-12.4
9	1	-3	17.7	-18.5	1	2	-10	22.4	-21.8	4	2	-8	11.0	11.4	7	2	0	28.5	-29.0
9	1	-2	-7.2	-6.3	1	2	-9	17.6	18.8	4	2	-7	19.0	-17.9	7	2	1	16.8	-17.2
9	1	-1	-4.0	-5.0	1	2	-8	40.9	39.7	4	2	-6	28.8	28.2	7	2	2	16.3	-14.1
9	1	0	-5.5	9.2	1	2	-7	-0.3	-0.6	4	2	-5	82.2	-82.0	7	2	3	25.5	26.2
9	1	1	30.3	31.2	1	2	-6	17.6	16.4	4	2	-4	49.8	-49.4	7	2	4	29.4	28.4
9	1	2	17.6	17.3	1	2	-5	-0.3	1.0	4	2	-3	29.1	29.7	7	2	5	-5.4	6.3
9	1	3	28.8	-28.8	1	2	-4	90.1	-88.7	4	2	-2	-1.5	2.5	7	2	6	22.5	-22.2
9	1	4	-0.5	2.0	1	2	-3	65.2	63.9	4	2	-1	50.2	50.1	7	2	7	15.2	15.1
9	1	5	20.3	21.1	1	2	-2	45.8	46.6	4	2	0	18.9	19.1	7	2	8	-5.4	0.1
9	1	6	-0.5	2.0	1	2	-1	27.7	-25.5	4	2	1	46.9	46.1	7	2	9	-0.6	1.1
10	1	-16	-9.9	-12.8	1	2	0	15.8	16.4	4	2	2	64.7	-65.5	8	2	-17	-3.6	1.1
10	1	-15	16.6	-15.3	1	2	1	22.2	-19.5	4	2	3	-4.0	4.1	8	2	-16	-0.5	1.0
10	1	-14	-8.4	3.6	1	2	2	101.3	-101.2	4	2	4	36.7	36.4	8	2	-15	-2.2	-4.4
10	1	-13	14.8	15.4	1	2	3	46.8	-44.2	4	2	5	18.0	-18.7	8	2	-14	15.9	15.1
10	1	-12	-3.4	4.7	1	2	4	66.2	65.5	4	2	6	39.4	-39.3	8	2	-13	17.4	-17.0
10	1	-11	-0.5	-1.6	1	2	5	66.6	-64.8	4	2	7	26.1	25.2	8	2	-12	28.8	-29.0
10	1	-10	-0.5	3.4	1	2	6	62.3	-62.3	4	2	8	-0.5	1.1	8	2	-11	9.0	7.7
10	1	-9	-5.0	3.0	1	2	7	14.5	15.0	4	2	9	11.1	-9.3	8	2	-10	-7.5	4.9
10	1	-8	-0.5	0.6	1	2	8	21.7	21.5	4	2	10	21.8	22.3	8	2	-9	9.5	8.7
10	1	-7	-3.7	2.0	1	2	9	26.6	27.8	4	2	11	20.7	-19.6	8	2	-8	30.2	30.3
10	1	-6	-0.4	-2.2	1	2	10	-3.8	-2.1	4	2	12	17.1	-18.2	8	2	-7	9.9	-10.3
10	1	-5	-5.9	-5.3	1	2	11	-6.3	-7.7	5	2	-17	-10.1	5.6	8	2	-6	38.5	-37.9
10	1	-4	-4.7	-7.8	1	2	12	28.3	-29.1	5	2	-16	14.9	-14.8	8	2	-5	30.4	30.1
10	1	-3	-0.5	7.8	1	2	13	-0.5	7.0	5	2	-15	11.7	11.7	8	2	-4	31.1	31.2
10	1	-2	-7.5	-10.0	1	2	14	15.9	14.6	5	2	-14	18.6	18.6	8	2	-3	-3.3	-2.7
10	1	-1	-0.5	1.8	2	2	-16	-6.2	-6.6	5	2	-13	-3.5	-3.8	8	2	-2	14.8	14.7
10	1	0	18.8	-18.7	2	2	-15	10.9	9.6	5	2	-12	22.5	-22.6	8	2	-1	16.4	-17.3
10	1	1	30.0	-28.3	2	2	-14	-7.1	6.5	5	2	-11	23.5	24.4	8	2	0	-6.1	-6.1
10	1	2	10.9	12.2	2	2	-13	-0.5	-3.6	5	2	-10	8.6	-7.6	8	2	1	-4.9	1.8
10	1	3	-0.5	-0.7	2	2	-12	19.2	-19.6	5	2	-9	18.1	18.1	8	2	2	30.5	30.6
10	1	4	11.0	10.3	2	2	-11	11.4	10.7	5	2	-8	48.6	49.6	8	2	3	13.3	-13.0
11	1	-15	-3.5	3.2	2	2	-10	34.3	36.1	5	2	-7	14.8	-14.7	8	2	4	21.3	-20.2
11	1	-14	-6.4	-1.8	2	2	-9	-0.4											

H	K	L	FO	FC	H	K	L	FO	FC	H	K	L	FO	FC	H	K	L	FO	FC
9	2	-6	-3.1	-6.1	1	3	-8	59.4	59.6	4	3	-2	-0.3	2.7	8	3	-13	-7.1	-7.5
9	2	-5	10.6	-11.0	1	3	-7	45.1	46.6	4	3	-1	34.9	34.4	8	3	-12	23.4	-22.4
9	2	-4	25.9	25.6	1	3	-6	45.5	-45.2	4	3	0	70.8	-74.1	8	3	-11	26.6	-26.6
9	2	-3	26.3	-26.0	1	3	-5	24.6	22.9	4	3	1	35.3	-36.8	8	3	-10	14.5	14.7
9	2	-2	29.0	-28.8	1	3	-4	49.6	46.8	4	3	2	26.6	26.8	8	3	-9	37.9	37.6
9	2	-1	-0.4	-1.6	1	3	-3	73.3	-67.7	4	3	3	20.9	21.6	8	3	-8	7.8	-5.8
9	2	0	13.1	12.3	1	3	-2	41.3	-39.3	4	3	4	-5.9	-7.4	8	3	-7	16.7	-17.2
9	2	1	-6.2	5.5	1	3	-1	60.0	55.5	4	3	5	12.0	12.4	8	3	-6	14.5	13.3
9	2	2	9.5	9.2	1	3	0	28.9	26.3	4	3	6	9.2	-9.3	8	3	-5	31.9	-31.6
9	2	3	-9.7	10.9	1	3	1	29.6	-30.8	4	3	7	33.9	-33.8	8	3	-4	8.6	7.1
9	2	4	17.9	-18.1	1	3	2	17.0	17.6	4	3	8	-0.5	3.6	8	3	-3	36.2	37.2
9	2	5	-7.8	8.1	1	3	3	14.4	14.6	4	3	9	22.5	22.9	8	3	-2	8.6	-8.4
9	2	6	-7.4	7.4	1	3	4	26.0	-26.5	4	3	10	10.5	-7.9	8	3	-1	18.5	-17.8
10	2	-16	11.3	-10.9	1	3	5	14.4	14.3	4	3	11	-6.3	-9.6	8	3	0	-5.2	-4.6
10	2	-15	-4.9	-3.3	1	3	6	15.3	15.3	5	3	-16	14.6	16.8	8	3	1	20.6	22.1
10	2	-14	-3.4	-3.5	1	3	7	23.9	-23.7	5	3	-15	-0.5	1.1	8	3	2	13.4	13.9
10	2	-13	-9.8	11.9	1	3	8	55.7	54.9	5	3	-14	19.9	-20.0	8	3	3	-8.2	7.8
10	2	-12	15.5	13.0	1	3	9	17.4	17.5	5	3	-13	-7.6	-4.4	8	3	4	16.5	-10.6
10	2	-11	-0.5	0.8	1	3	10	18.4	-18.7	5	3	-12	-3.6	-3.0	8	3	5	23.7	-19.9
10	2	-10	21.4	-22.2	1	3	11	13.1	-13.8	5	3	-11	26.2	-26.1	8	3	6	17.8	17.1
10	2	-9	16.7	17.6	1	3	12	18.4	-18.6	5	3	-10	12.9	13.4	8	3	7	-8.5	8.7
10	2	-8	-0.5	3.3	1	3	13	13.1	-13.0	5	3	-9	30.8	30.9	9	3	-16	-7.1	-7.8
10	2	-7	11.5	11.3	1	3	14	-4.9	4.2	5	3	-8	29.9	-30.0	9	3	-15	-6.6	-1.1
10	2	-6	-7.2	7.8	2	3	-15	-6.9	10.7	5	3	-7	10.3	-11.3	9	3	-14	-0.5	-5.7
10	2	-5	18.4	-18.8	2	3	-14	14.1	-12.9	5	3	-6	15.3	-15.3	9	3	-13	14.7	-13.0
10	2	-4	12.3	-12.4	2	3	-13	10.3	-8.5	5	3	-5	17.5	16.9	9	3	-12	17.3	18.3
10	2	-3	-6.9	9.3	2	3	-12	-0.5	-3.2	5	3	-4	22.4	23.9	9	3	-11	36.4	35.6
10	2	-2	-7.7	6.2	2	3	-11	-5.1	-3.0	5	3	-3	45.5	47.0	9	3	-10	-8.1	6.4
10	2	-1	-3.0	-2.7	2	3	-10	12.6	13.3	5	3	-2	26.0	-26.9	9	3	-9	-3.5	2.0
10	2	0	24.5	24.4	2	3	-9	70.0	70.6	5	3	-1	21.2	-22.7	9	3	-8	-0.5	-0.4
10	2	1	-0.5	6.0	2	3	-8	23.0	-22.3	5	3	0	-3.4	-1.6	9	3	-7	26.2	-27.3
10	2	2	16.6	-16.2	2	3	-7	21.6	-21.6	5	3	1	9.8	-10.7	9	3	-6	20.0	20.3
10	2	3	11.9	10.3	2	3	-6	5.5	5.2	5	3	2	7.2	8.5	9	3	-5	9.2	8.6
10	2	4	16.9	15.8	2	3	-5	35.5	-31.7	5	3	3	18.0	-18.6	9	3	-4	17.4	-16.0
11	2	-15	-3.1	6.5	2	3	-4	-0.3	0.8	5	3	4	46.4	-46.6	9	3	-3	13.1	-11.6
11	2	-14	28.4	27.3	2	3	-3	-0.3	2.9	5	3	5	23.2	-22.1	9	3	-2	-7.8	8.3
11	2	-13	-4.7	-3.4	2	3	-2	82.3	-84.0	5	3	6	25.8	29.5	9	3	-1	-5.9	4.1
11	2	-12	16.7	-18.5	2	3	-1	48.4	-50.1	5	3	7	10.1	8.9	9	3	0	-7.5	-1.0
11	2	-11	-5.3	0.6	2	3	0	49.6	-47.3	5	3	8	-6.7	-2.0	9	3	1	22.2	22.0
11	2	-10	-1.0	2.2	2	3	1	6.7	7.6	5	3	9	-4.4	5.8	9	3	2	-6.5	-6.9
11	2	-9	-6.7	2.5	2	3	2	20.0	-19.1	5	3	10	-0.5	0.5	9	3	3	17.9	-17.2
11	2	-8	16.0	13.8	2	3	3	19.2	19.3	6	3	-16	-0.5	-0.6	9	3	4	-9.3	10.5
11	2	-7	22.7	-22.3	2	3	4	6.0	-5.9	6	3	-15	-6.7	8.1	9	3	5	12.1	11.5
11	2	-6	30.4	-29.8	2	3	5	19.8	-19.8	6	3	-14	-4.4	5.0	10	3	-15	-4.6	-4.1
11	2	-5	-5.5	-3.6	2	3	6	49.9	49.8	6	3	-13	25.9	-25.7	10	3	-14	-7.6	4.1
11	2	-4	19.8	19.4	2	3	7	29.8	25.3	6	3	-12	17.1	17.8	10	3	-13	13.2	12.8
11	2	-3	-0.5	3.0	2	3	8	29.7	-25.6	6	3	-11	-0.4	-3.2	10	3	-12	13.4	-13.0
11	2	-2	-4.9	-0.6	2	3	9	11.6	-8.8	6	3	-10	32.8	-32.5	10	3	-11	17.4	-17.0
11	2	-1	-0.5	-6.2	2	3	10	16.0	-15.8	6	3	-9	7.5	7.8	10	3	-10	19.9	-17.8
11	2	0	-3.8	-6.1	2	3	11	15.7	-15.0	6	3	-8	-6.3	7.2	10	3	-9	-2.4	-4.0
11	2	1	-2.8	5.0	2	3	12	19.7	18.7	6	3	-7	26.3	-26.6	10	3	-8	31.8	31.3
11	2	2	17.6	17.2	2	3	13	14.6	14.6	6	3	-6	51.8	53.4	10	3	-7	11.0	9.7
12	2	-14	-9.4	-9.1	3	3	-16	14.0	-13.2	6	3	-5	33.1	34.5	10	3	-6	20.2	-20.0
12	2	-13	-4.0	6.6	3	3	-15	-4.9	-0.7	6	3	-4	-1.4	3.7	10	3	-5	-4.3	-6.1
12	2	-12	-8.3	-5.8	3	3	-14	-0.5	5.5	6	3	-3	14.4	-14.6	10	3	-4	-7.8	2.3
12	2	-11	14.6	10.7	3	3	-13	17.3	-17.2	6	3	-2	7.2	-5.9	10	3	-3	-0.5	-5.4
12	2	-10	19.7	18.9	3	3	-12	-0.5	2.3	6	3	-1	6.3	6.2	10	3	-2	-5.5	-2.8
12	2	-9	-6.7	-1.3	3	3	-11	25.1	26.1	6	3	0	17.1	17.7	10	3	-1	15.8	15.5
12	2	-8	27.5	-28.3	3	3	-10	-1.5	-2.2	6	3	1	18.5	17.9	10	3	0	18.7	-17.8
12	2	-7	-0.5	0.9	3	3	-9	53.8	-53.7	6	3	2	7.8	-8.7	10	3	1	-8.3	5.2
12	2	-6	12.7	10.1	3	3	-8	9.3	9.2	6	3	3	-4.1	-7.2	10	3	2	-9.4	8.1
12	2	-5	-0.5	-7.2	3	3	-7	22.0	20.5	6	3	4	28.2	28.4	10	3	3	-0.5	0.7
12	2	-4	-0.5	1.9	3	3	-6	47.4	46.9	6	3	5	-0.8	-1.5	11	3	-14	-8.2	-8.6
12	2	-3	11.3	-8.4	3	3	-5	77.4	77.2	6	3	6	15.5	-15.9	11	3	-13	-4.8	5.9
12	2	-2	12.4	-11.8	3	3	-4	42.3	-42.7	6	3	7	-0.5	3.4	11	3	-12	-0.5	6.4
12	2	-1	12.1	12.2	3	3	-3	67.3	-68.1	6	3	8	-0.5	-1.7	11	3	-11	10.6	-10.3
13	2	-11	14.3	-14.3	3	3	-2	35.1	38.0	6	3	9	11.8	-9.8	11	3	-10	12.4	13.9
13	2	-10	-5.4	-4.2	3	3	-1	11.1	11.4	7	3	-16	14.9	-14.8	11	3	-9	13.3	11.4
13	2	-9	-5.3	4.5	3	3	0	11.3	-11.0	7	3	-15	23.5	-24.3	11	3	-8	-9.1	-8.9
13	2	-8	-5.0	2.9	3	3	1	43.1	43.7	7	3	-14	16.0	15.3	11	3	-7	22.9	-22.2
13	2	-7	-7.9	7.7	3	3	2	30.2	-31.4	7	3	-13	21.1	21.0	11	3	-6	-0.5	-1.2
13	2	-6	-0.5	3.8	3	3	3	47.1	-47.4	7	3	-12	-7.6	-7.8	11	3	-5	-3.6	-5.1
13	2	-5	-8.8	-3.8	3	3	4	41.5	42.8	7	3	-11	-6.3	-2.2	11	3	-4	19.5	18.5
13	2	-4	-10.3	-10.3	3	3	5	20.4	15.9	7	3	-10	-3.7	-6.5	11	3	-3	16.1	15.5
13	2	-3	88.0	-83.3	3	3	6	7.6	8.7	7	3	-9	15.6	-15.4	11	3	-2	-0.5	-5.5
13	2	-2	14.3	13.0	3	3	7	33.9	-34.3	7	3	-8	29.3	30.3	11	3	-1	-7.9	-3.2
13	2	-1	20.3	-20.1	3	3	8	19.7	19.8	7	3	-7	43.2	43.8	11	3	0	12.3	6.5
13	2	0	58.9	56.5	3	3	9	20.4	-20.9	7	3	-6	47.5	-48.6	11	3	1	-0.5	0.0
13	2	1	82.4	82.6	3	3	10	14.1	15.3	7	3	-5	12.2	12.1	12	3	-13	12.0	-12.8
13	2	2	5.6	-5.1	3	3	11	32.7	33.1	7	3	-4	9.0	9.5	12	3	-12	-5.2	2.0
13	2	3	16.5	-10.6	3	3	12	10.6	-7.7	7	3	-3	24.2	-24.8	12	3	-11	10.7	11.5
13	2	4	-5.6	6.8	4	3	-16	-0.5	-5.3	7	3	-2	-3.2	6.2	12	3	-10	-10.0	-9.1
13	2	5	8.0</																

H	K	L	FO	FC	H	K	L	FO	FC	H	K	L	FO	FC	H	K	L	FO	FC
0	4	1	21.8	-21.9	3	4	10	14.4	14.6	7	4	-4	33.8	-35.2	0	5	2	11.8	10.1
0	4	2	84.0	-84.2	3	4	11	-4.5	-1.3	7	4	-3	28.9	30.5	0	5	3	-0.4	-2.4
0	4	3	-4.5	-2.4	3	4	12	-6.8	7.7	7	4	-2	-3.0	-3.0	0	5	4	27.9	27.6
0	4	4	40.1	39.7	4	4	-15	-0.5	1.7	7	4	-1	23.1	-23.4	0	5	5	13.9	14.4
0	4	5	19.8	19.8	4	4	-14	9.9	1.5	7	4	0	18.4	-17.9	0	5	6	22.9	-23.3
0	4	6	48.0	45.5	4	4	-13	11.4	12.5	7	4	1	-0.4	-0.9	0	5	7	13.1	-10.5
0	4	7	47.3	-47.7	4	4	-12	34.0	34.6	7	4	2	17.4	18.1	0	5	8	23.2	-26.2
0	4	8	33.7	-34.0	4	4	-11	12.1	-11.0	7	4	3	28.8	28.7	0	5	9	-3.8	-4.2
0	4	9	16.6	16.2	4	4	-10	34.2	-33.7	7	4	4	-4.4	6.8	0	5	10	38.0	38.4
0	4	10	-2.2	0.9	4	4	-9	22.9	22.2	7	4	5	22.8	-22.1	0	5	11	-5.9	5.3
0	4	11	-2.0	0.4	4	4	-8	-4.9	2.5	7	4	6	-8.8	-8.3	0	5	12	20.1	-18.9
0	4	12	-0.5	2.8	4	4	-7	-5.1	-5.4	7	4	7	-6.0	4.8	0	5	13	-6.2	-1.4
0	4	13	13.4	-15.0	4	4	-6	-5.2	5.0	8	4	-15	10.9	12.7	1	5	-14	19.7	18.9
0	4	14	14.3	-14.3	4	4	-5	27.3	-28.9	8	4	-14	11.6	11.0	1	5	-13	10.7	11.9
1	4	-14	-0.5	-0.3	4	4	-4	29.5	-29.2	8	4	-13	13.6	-15.7	1	5	-12	-0.5	1.3
1	4	-13	-4.6	5.9	4	4	-3	39.2	40.1	8	4	-12	11.7	-11.6	1	5	-11	-5.3	2.7
1	4	-12	10.2	8.3	4	4	-2	28.2	29.4	8	4	-11	20.0	19.4	1	5	-10	11.4	11.3
1	4	-11	29.0	-29.7	4	4	-1	58.0	-59.5	8	4	-10	16.3	14.1	1	5	-9	20.4	-20.5
1	4	-10	31.0	-31.9	4	4	0	-4.7	5.5	8	4	-9	10.3	7.1	1	5	-8	19.9	20.3
1	4	-9	36.3	34.1	4	4	1	-4.0	-1.9	8	4	-8	-0.5	-0.7	1	5	-7	-6.2	5.5
1	4	-8	23.0	22.8	4	4	2	-3.3	-4.3	8	4	-7	28.5	-28.5	1	5	-6	51.2	-51.1
1	4	-7	49.1	-48.6	4	4	3	20.9	20.3	8	4	-6	21.1	-20.5	1	5	-5	7.1	-7.1
1	4	-6	-2.3	3.1	4	4	4	32.9	33.4	8	4	-5	20.6	21.4	1	5	-4	27.0	27.0
1	4	-5	66.4	-64.6	4	4	5	16.5	-14.7	8	4	-4	-4.9	2.8	1	5	-3	16.4	-15.5
1	4	-4	20.1	-20.4	4	4	6	-0.4	-3.8	8	4	-3	-4.5	-6.3	1	5	-2	7.4	7.0
1	4	-3	42.4	41.9	4	4	7	23.7	27.2	8	4	-2	-3.2	2.3	1	5	-1	9.3	11.1
1	4	-2	30.1	28.7	4	4	8	16.0	-15.9	8	4	-1	-8.4	-7.5	1	5	0	25.3	-25.5
1	4	-1	52.6	-55.4	4	4	9	14.0	13.9	8	4	0	14.2	-15.2	1	5	1	19.2	-19.1
1	4	0	11.1	-12.6	4	4	10	-9.6	12.4	8	4	1	15.1	15.6	1	5	2	63.6	63.5
1	4	1	9.5	9.9	4	4	11	-0.5	-4.4	8	4	2	-8.1	8.9	1	5	3	-4.4	4.3
1	4	2	18.3	17.9	5	4	-16	-0.4	-4.4	8	4	3	18.9	-17.7	1	5	4	-5.2	6.5
1	4	3	39.3	38.8	5	4	-15	17.0	17.8	8	4	4	-0.5	0.5	1	5	5	22.0	22.3
1	4	4	35.3	35.3	5	4	-14	11.5	12.7	8	4	5	12.9	-13.2	1	5	6	12.4	-11.8
1	4	5	12.9	-13.1	5	4	-13	18.8	-18.8	8	4	6	-0.5	0.9	1	5	7	20.9	-22.0
1	4	6	20.2	-19.7	5	4	-12	30.9	-31.9	9	4	-15	14.8	-15.4	1	5	8	14.1	13.5
1	4	7	-0.4	-1.6	5	4	-11	10.6	8.9	9	4	-14	-9.8	-10.9	1	5	9	-8.9	-10.1
1	4	8	-4.5	-3.4	5	4	-10	11.1	11.9	9	4	-13	-9.4	7.3	1	5	10	36.8	-36.7
1	4	9	-5.5	1.4	5	4	-9	10.4	11.5	9	4	-12	-3.9	0.1	1	5	11	-0.5	-2.4
1	4	10	9.8	9.5	5	4	-8	29.4	29.8	9	4	-11	-6.8	1.1	1	5	12	13.4	14.6
1	4	11	18.4	-18.3	5	4	-7	15.8	15.9	9	4	-10	29.8	31.3	2	5	-14	-8.9	-4.5
1	4	12	22.9	-22.6	5	4	-6	35.2	-35.7	9	4	-9	32.2	-32.6	2	5	-13	-5.1	-4.1
1	4	13	23.3	23.5	5	4	-5	29.3	29.5	9	4	-8	-6.4	1.0	2	5	-12	12.4	-15.4
2	4	-15	-0.5	3.3	5	4	-4	-3.4	3.1	9	4	-7	23.2	23.5	2	5	-11	15.0	-15.1
2	4	-14	-0.5	6.8	5	4	-3	-1.4	-5.6	9	4	-6	18.4	-19.1	2	5	-10	20.6	21.0
2	4	-13	-3.3	-4.7	5	4	-2	-5.8	8.9	9	4	-5	-7.1	5.1	2	5	-9	18.1	18.0
2	4	-12	22.4	-20.8	5	4	-1	25.9	-25.5	9	4	-4	10.8	12.3	2	5	-8	17.3	-16.8
2	4	-11	32.7	32.8	5	4	0	10.8	-10.8	9	4	-3	-0.5	-5.1	2	5	-7	12.3	-12.4
2	4	-10	32.7	33.9	5	4	1	34.2	38.1	9	4	-2	21.7	-21.8	2	5	-6	8.8	9.0
2	4	-9	-6.9	7.7	5	4	2	14.3	16.8	9	4	-1	14.7	11.9	2	5	-5	23.5	-23.4
2	4	-8	-4.1	1.3	5	4	3	29.6	-30.2	9	4	0	14.2	15.2	2	5	-4	8.4	8.6
2	4	-7	45.0	-45.8	5	4	4	19.7	-19.4	9	4	1	16.1	-15.6	2	5	-3	-0.4	1.8
2	4	-6	9.8	-11.8	5	4	5	13.9	12.4	9	4	2	-0.5	2.4	2	5	-2	60.8	-61.4
2	4	-5	67.5	66.8	5	4	6	21.4	-20.7	9	4	3	-8.7	-7.9	2	5	-1	-2.4	1.7
2	4	-4	30.5	-29.3	5	4	7	15.5	12.8	9	4	4	-8.6	-5.1	2	5	0	62.7	63.1
2	4	-3	-4.9	-5.1	5	4	8	28.0	28.4	10	4	-14	-0.5	2.0	2	5	1	22.6	22.8
2	4	-2	-5.0	3.4	5	4	9	21.1	-19.4	10	4	-13	11.7	8.7	2	5	2	30.4	-30.3
2	4	-1	12.3	-12.0	5	4	10	15.1	-14.0	10	4	-12	13.3	13.0	2	5	3	29.7	29.0
2	4	0	5.2	4.4	6	4	-16	-0.5	5.9	10	4	-11	19.6	-19.6	2	5	4	44.5	-44.5
2	4	1	49.8	50.7	6	4	-15	28.9	-29.1	10	4	-10	22.4	-23.5	2	5	5	19.0	-19.4
2	4	2	-4.7	5.7	6	4	-14	11.8	-8.8	10	4	-9	12.3	11.9	2	5	6	-7.5	5.1
2	4	3	16.5	-14.4	6	4	-13	-9.0	6.4	10	4	-8	-3.9	4.2	2	5	7	-9.9	7.0
2	4	4	-5.1	-5.2	6	4	-12	-5.3	4.1	10	4	-7	12.3	10.7	2	5	8	-6.3	-3.9
2	4	5	-4.8	-4.4	6	4	-11	14.8	14.9	10	4	-6	13.9	14.1	2	5	9	-5.7	4.5
2	4	6	22.7	22.4	6	4	-10	-2.9	6.9	10	4	-5	20.4	-21.2	2	5	10	-1.8	-1.3
2	4	7	24.3	24.1	6	4	-9	-3.3	3.9	10	4	-4	14.8	-14.0	2	5	11	10.6	-9.1
2	4	8	-5.8	4.6	6	4	-8	23.3	-22.7	10	4	-3	33.3	33.3	2	5	12	22.0	22.6
2	4	9	12.8	-11.0	6	4	-7	-4.1	4.9	10	4	-2	-5.9	2.0	3	5	-14	-6.6	-8.6
2	4	10	27.5	-28.2	6	4	-6	7.8	7.6	10	4	-1	-6.3	2.6	3	5	-13	-3.6	0.6
2	4	11	24.8	25.1	6	4	-5	33.1	-35.1	10	4	0	-8.9	9.2	3	5	-12	14.3	11.5
2	4	12	-5.4	2.2	6	4	-4	11.0	10.4	10	4	1	-5.9	1.6	3	5	-11	20.1	19.3
3	4	-15	-4.0	-5.2	6	4	-3	17.1	-18.1	10	4	2	-0.5	-4.7	3	5	-10	21.9	-22.4
3	4	-14	-0.5	0.9	6	4	-2	31.9	-33.8	11	4	-13	-7.7	-9.7	3	5	-9	11.9	-12.1
3	4	-13	15.4	14.9	6	4	-1	11.3	11.7	11	4	-12	14.3	-14.9	3	5	-8	-6.8	6.4
3	4	-12	-0.5	2.1	6	4	0	24.9	25.0	11	4	-11	-0.5	-2.4	3	5	-7	-5.9	-7.2
3	4	-11	-6.7	-6.1	6	4	1	39.8	-41.3	11	4	-10	-9.0	12.7	3	5	-6	-4.8	-1.5
3	4	-10	-5.8	-4.0	6	4	2	13.0	-12.3	11	4	-9	-5.4	3.3	3	5	-5	22.5	22.4
3	4	-9	23.4	-23.8	6	4	3	9.9	-9.6	11	4	-8	-4.9	1.4	3	5	-4	33.6	-34.8
3	4	-8	31.4	-31.4	6	4	4	13.3	14.8	11	4	-7	12.5	-12.5	3	5	-3	20.1	-20.6
3	4	-7	20.5	20.2	6	4	5	23.3	23.3	11	4	-6	18.6	-19.0	3	5	-2	73.4	73.3
3	4	-6	10.4	10.6	6	4	6	15.6	15.0	11	4	-5	12.4	12.7	3	5	-1	8.3	8.7
3	4	-5	32.8	-31.9	6	4	7	13.7	-14.7	11	4	-4	12.1	11.7	3	5	0	22.1	23.7
3	4	-4	16.2	15.9	6	4	8	14.7	-14.1	11	4	-3	-0.5	0.4	3	5	1	-3.6	4.4
3	4	-3	49.7	-50.5	6	4	9	-2.8	8.6	11	4	-2							

H	K	L	FO	FC	H	K	L	FO	FC	H	K	L	FO	FC	H	K	L	FO	FC
4	5	-12	20.4	-19.8	8	5	-13	-0.5	1.7	1	6	8	21.9	23.0	5	6	6	12.1	-11.2
4	5	-11	12.3	-12.2	8	5	-12	11.2	-9.8	1	6	9	-0.5	-1.2	5	6	7	12.4	8.5
4	5	-10	-7.8	5.4	8	5	-11	-0.5	-2.4	1	6	10	17.2	17.0	5	6	8	-9.7	-6.4
4	5	-9	-7.4	-7.3	8	5	-10	26.1	24.5	1	6	11	-10.0	-9.8	6	6	-13	11.6	8.6
4	5	-8	24.6	24.3	8	5	-9	28.4	29.5	2	6	-13	22.0	-22.4	6	6	-12	-9.5	11.5
4	5	-7	26.5	24.7	8	5	-8	26.8	-27.1	2	6	-12	-1.2	7.3	6	6	-11	12.3	10.5
4	5	-6	15.7	-14.8	8	5	-7	11.9	-10.8	2	6	-11	-5.4	8.4	6	6	-10	-5.8	-1.8
4	5	-5	29.4	-30.0	8	5	-6	16.3	-17.1	2	6	-10	23.7	-24.3	6	6	-9	10.4	-11.8
4	5	-4	24.5	24.0	8	5	-5	11.8	-10.4	2	6	-9	13.1	13.7	6	6	-8	-8.2	-10.4
4	5	-3	14.1	-15.2	8	5	-4	14.1	12.3	2	6	-8	10.5	-10.0	6	6	-7	16.7	15.1
4	5	-2	21.8	22.4	8	5	-3	14.5	16.2	2	6	-7	32.3	-31.0	6	6	-6	10.4	10.2
4	5	-1	14.7	-14.6	8	5	-2	13.3	-11.4	2	6	-6	23.0	23.6	6	6	-5	26.2	-25.3
4	5	0	76.1	-79.1	8	5	-1	13.8	-12.4	2	6	-5	46.1	45.7	6	6	-4	-7.6	-2.9
4	5	1	8.0	-7.6	8	5	0	18.4	18.5	2	6	-4	35.5	35.7	6	6	-3	-7.4	-9.9
4	5	2	42.1	42.7	8	5	1	-8.1	5.3	2	6	-3	24.6	-24.4	6	6	-2	-5.7	1.8
4	5	3	23.5	23.4	8	5	2	-8.0	7.9	2	6	-2	9.7	-11.1	6	6	-1	24.2	25.3
4	5	4	14.9	-15.3	8	5	3	12.0	11.2	2	6	-1	9.1	9.5	6	6	0	-0.5	-1.8
4	5	5	10.7	-9.5	8	5	4	-9.6	-6.7	2	6	0	-0.4	6.3	6	6	1	12.7	-13.7
4	5	6	22.8	-21.9	8	5	5	-6.5	-9.2	2	6	1	49.2	47.8	6	6	2	-5.9	2.0
4	5	7	15.5	-16.8	9	5	-14	-8.7	-10.5	2	6	2	11.4	-12.1	6	6	3	-0.5	-4.5
4	5	8	18.6	18.8	9	5	-13	-0.5	-0.6	2	6	3	32.6	-32.0	6	6	4	-5.8	-2.5
4	5	9	14.7	13.8	9	5	-12	26.0	26.7	2	6	4	15.5	-16.1	6	6	5	19.9	19.9
4	5	10	-7.7	-1.7	9	5	-11	-9.7	6.8	2	6	5	11.2	-8.6	6	6	6	-9.3	6.7
5	5	-15	-6.5	3.8	9	5	-10	12.5	-9.9	2	6	6	-5.8	-1.8	7	6	-13	15.4	16.0
5	5	-14	14.5	-12.2	9	5	-9	-5.9	-6.9	2	6	7	-9.0	10.0	7	6	-12	-7.5	-2.3
5	5	-13	-0.5	-1.9	9	5	-8	-0.5	-4.1	2	6	8	11.5	-7.5	7	6	-11	18.8	-19.3
5	5	-12	15.1	-15.0	9	5	-7	-9.4	-9.3	2	6	9	20.0	-18.8	7	6	-10	-2.1	2.5
5	5	-11	-2.7	-7.0	9	5	-6	-8.4	12.1	2	6	10	-7.9	7.1	7	6	-9	23.7	22.6
5	5	-10	-7.7	6.3	9	5	-5	9.4	9.7	2	6	11	16.9	15.7	7	6	-8	9.6	6.2
5	5	-9	9.3	10.8	9	5	-4	13.4	-14.1	3	6	-13	12.3	13.5	7	6	-7	16.7	-16.0
5	5	-8	31.5	-31.2	9	5	-3	-8.9	-9.4	3	6	-12	-9.6	-6.5	7	6	-6	11.9	-11.3
5	5	-7	-2.4	-4.2	9	5	-2	23.7	23.4	3	6	-11	-9.8	0.7	7	6	-5	20.1	-20.5
5	5	-6	-5.9	4.6	9	5	-1	-6.8	-5.5	3	6	-10	-2.7	5.3	7	6	-4	-3.5	2.7
5	5	-5	7.2	-6.0	9	5	0	-4.8	2.2	3	6	-9	26.4	-25.2	7	6	-3	26.0	26.9
5	5	-4	39.3	41.0	9	5	1	-4.8	4.0	3	6	-8	-3.7	-1.8	7	6	-2	11.8	11.2
5	5	-3	7.0	7.4	9	5	2	16.1	-14.6	3	6	-7	20.1	19.6	7	6	-1	-8.7	-5.1
5	5	-2	50.1	-52.8	9	5	3	14.8	-14.9	3	6	-6	16.5	-17.1	7	6	0	-6.1	5.8
5	5	-1	-6.6	7.9	10	5	-13	-6.7	-1.9	3	6	-5	19.6	-20.3	7	6	1	-8.7	-2.8
5	5	0	30.5	30.4	10	5	-12	-0.5	-3.9	3	6	-4	22.0	-22.0	7	6	2	-7.6	2.8
5	5	1	-3.4	-3.0	10	5	-11	-0.5	1.1	3	6	-3	-2.4	-4.4	7	6	3	29.2	28.7
5	5	2	8.3	8.5	10	5	-10	13.1	-14.3	3	6	-2	18.1	18.3	7	6	4	-1.6	2.2
5	5	3	10.0	5.9	10	5	-9	-4.4	6.8	3	6	-1	46.5	49.6	7	6	5	24.3	-21.5
5	5	4	29.4	-29.1	10	5	-8	-4.5	5.8	3	6	0	11.9	-11.0	8	6	-13	-10.0	-8.9
5	5	5	-8.3	8.4	10	5	-7	-5.8	5.0	3	6	1	22.0	-21.5	8	6	-12	-3.2	2.9
5	5	6	14.2	14.5	10	5	-6	22.1	-22.7	3	6	2	18.4	-17.5	8	6	-11	13.0	10.3
5	5	7	17.4	16.6	10	5	-5	-4.4	-8.4	3	6	3	-7.1	-2.9	8	6	-10	-7.7	-7.4
5	5	8	-5.5	-6.3	10	5	-4	-8.3	8.1	3	6	4	-5.2	-2.3	8	6	-9	-0.5	1.5
5	5	9	-0.5	-0.2	10	5	-3	-0.5	-4.1	3	6	5	-0.5	-1.5	8	6	-8	-7.4	0.8
5	5	10	-5.5	-1.9	10	5	-2	17.2	15.6	3	6	6	11.8	12.6	8	6	-7	26.0	-24.7
6	5	-15	22.0	-23.0	10	5	-1	-6.6	1.4	3	6	7	22.4	-22.3	8	6	-6	9.7	-7.1
6	5	-14	-0.5	1.9	10	5	0	24.1	-24.3	3	6	8	12.1	7.0	8	6	-5	23.5	23.9
6	5	-13	37.3	37.3	10	5	1	-0.6	2.1	3	6	9	12.3	8.3	8	6	-4	-6.8	3.3
6	5	-12	-0.5	3.1	11	5	-11	-0.5	-0.4	3	6	10	-2.9	-1.1	8	6	-3	16.7	-17.0
6	5	-11	10.2	-6.6	11	5	-10	11.1	11.1	4	6	-13	-0.5	2.5	8	6	-2	-6.4	-6.2
6	5	-10	10.2	11.5	11	5	-9	-6.8	6.0	4	6	-12	-0.5	1.8	8	6	-1	12.1	-11.7
6	5	-9	21.9	21.4	11	5	-8	-0.5	3.2	4	6	-11	27.9	-28.7	8	6	0	-7.7	-7.2
6	5	-8	-5.0	-5.8	11	5	-7	-0.5	-2.1	4	6	-10	11.2	-10.8	8	6	1	26.5	27.0
6	5	-7	7.9	-9.0	11	5	-6	-5.4	2.1	4	6	-9	11.5	11.4	8	6	2	-10.3	-9.1
6	5	-6	8.2	6.9	11	5	-5	-7.3	3.5	4	6	-8	-5.7	5.2	8	6	3	-10.3	-8.0
6	5	-5	24.3	-25.2	11	5	-4	15.5	15.5	4	6	-7	-7.3	6.1	9	6	-12	14.7	-15.4
6	5	-4	9.7	-9.4	11	5	-3	-7.7	2.6	4	6	-6	34.0	35.1	9	6	-11	15.3	13.4
6	5	-3	21.8	21.2	11	5	-2	23.9	-23.3	4	6	-5	14.1	-14.6	9	6	-10	-4.4	-4.0
6	5	-2	16.4	-16.7	0	6	0	12.3	13.7	4	6	-4	-1.8	0.8	9	6	-9	24.5	-24.9
6	5	-1	18.2	19.0	0	6	1	23.6	-24.6	4	6	-3	32.6	33.9	9	6	-8	-8.2	6.2
6	5	0	-6.2	3.8	0	6	2	7.3	-6.5	4	6	-2	-3.4	6.6	9	6	-7	13.3	11.8
6	5	1	25.2	-24.7	0	6	3	-6.3	-6.9	4	6	-1	29.1	-30.1	9	6	-6	13.6	14.6
6	5	2	-3.6	1.2	0	6	4	17.0	-18.3	4	6	0	11.8	12.1	9	6	-5	12.8	-14.2
6	5	3	21.5	21.6	0	6	5	30.3	30.6	4	6	1	9.0	9.8	9	6	-4	-3.4	7.0
6	5	4	-0.5	-2.6	0	6	6	-5.9	6.9	4	6	2	12.7	-11.6	9	6	-3	-6.8	-1.4
6	5	5	-8.3	10.1	0	6	7	43.4	-42.7	4	6	3	28.9	27.9	9	6	-2	-0.5	-2.0
6	5	6	-0.5	-4.4	0	6	8	18.7	-19.1	4	6	4	15.6	15.6	9	6	-1	23.0	21.4
6	5	7	-8.0	-7.5	0	6	9	-4.9	6.9	4	6	5	32.7	-33.0	9	6	0	-0.5	-1.4
6	5	8	-9.4	-4.7	0	6	10	-0.5	-3.0	4	6	6	-9.0	-9.8	9	6	1	13.4	-11.3
6	5	9	28.1	26.5	0	6	11	-7.4	1.1	4	6	7	10.9	10.4	10	6	-10	11.8	7.1
6	5	10	-9.7	7.8	0	6	12	-5.8	1.2	4	6	8	-3.9	6.5	10	6	-9	-7.7	4.4
7	5	-12	14.8	-12.4	1	6	-12	-0.5	-1.3	4	6	9	-3.1	5.1	10	6	-8	-6.6	-5.6
7	5	-11	11.1	-11.0	1	6	-11	20.2	-21.2	5	6	-13	14.5	-17.3	10	6	-7	-9.1	4.0
7	5	-10	13.2	-13.2	1	6	-10	10.9	9.6	5	6	-12	-0.5	0.8	10	6	-6	-0.5	-3.5
7	5	-9	15.6	-15.3	1	6	-9	20.5	19.1	5	6	-11	14.1	13.0	10	6	-5	17.2	-15.5
7	5	-8	19.5	19.0	1	6	-8	-6.4	6.6	5	6	-10	-5.8	0.2	10	6	-4	-2.3	2.4
7	5	-7	14.9	15.4	1	6	-7	17.7	-17.6	5	6	-9	-6.9	4.3	10	6	-3	21.3	20.4
7	5	-6	18.8	-18.1	1	6	-6	8.5	-6.4	5	6	-8	10.6	10.8	10	6	-2	-6.8	3.0
7	5	-5	13.2	-12.9	1	6	-5	13.6	-13.7	5	6	-7	22.3	-21.5	0	7	1	27.2	28.1
7	5</																		

H	K	L	FO	FC	H	K	L	FO	FC	H	K	L	FO	FC	H	K	L	FO	FC	H	K	L	FO	FC
1	7	-8	26.8	28.6	4	7	7	-6.9	3.3	0	8	7	13.6	-14.6	5	8	-1	12.1	-12.1	5	8	-1	12.1	-12.1
1	7	-7	-7.2	-4.5	5	7	-12	-6.7	-2.6	0	8	8	-7.4	4.0	5	8	0	10.1	-12.3	5	8	0	10.1	-12.3
1	7	-6	21.2	-20.1	5	7	-11	-0.5	4.1	0	8	9	14.8	15.6	5	8	1	15.9	16.7	5	8	1	15.9	16.7
1	7	-5	-0.5	2.9	5	7	-10	26.5	25.9	1	8	-9	24.3	22.6	5	8	2	-8.7	3.8	5	8	2	-8.7	3.8
1	7	-4	35.0	34.6	5	7	-9	15.8	-16.3	1	8	-8	-0.5	-1.8	5	8	3	20.4	-20.1	5	8	3	20.4	-20.1
1	7	-3	11.5	-11.4	5	7	-8	14.7	-13.8	1	8	-7	-0.5	-2.0	5	8	4	-0.6	3.8	5	8	4	-0.6	3.8
1	7	-2	24.3	-25.1	5	7	-7	13.9	13.4	1	8	-6	-6.7	-2.8	6	8	-9	21.9	-19.9	6	8	-9	21.9	-19.9
1	7	-1	-6.4	2.1	5	7	-6	-4.5	-0.9	1	8	-5	-3.8	-6.7	6	8	-8	-11.1	3.3	6	8	-8	-11.1	3.3
1	7	0	20.6	-20.3	5	7	-5	9.2	8.7	1	8	-4	13.3	14.6	6	8	-7	21.7	21.5	6	8	-7	21.7	21.5
1	7	1	13.0	-12.1	5	7	-4	13.6	13.3	1	8	-3	33.2	33.2	6	8	-6	12.4	-11.1	6	8	-6	12.4	-11.1
1	7	2	35.3	34.8	5	7	-3	-5.5	-2.4	1	8	-2	-2.9	-2.7	6	8	-5	-7.3	10.4	6	8	-5	-7.3	10.4
1	7	3	19.8	-21.0	5	7	-2	27.0	-28.8	1	8	-1	20.1	-20.6	6	8	-4	-2.5	2.9	6	8	-4	-2.5	2.9
1	7	4	10.3	-10.8	5	7	-1	-6.1	1.6	1	8	0	-4.4	-1.0	6	8	-3	10.4	-8.8	6	8	-3	10.4	-8.8
1	7	5	-0.5	3.9	5	7	0	12.7	11.9	1	8	1	-4.1	-4.2	6	8	-2	-6.9	10.7	6	8	-2	-6.9	10.7
1	7	6	26.9	-26.5	5	7	1	-1.5	4.6	1	8	2	16.3	16.3	6	8	-1	17.8	17.9	6	8	-1	17.8	17.9
1	7	7	-9.4	-8.2	5	7	2	-8.9	11.0	1	8	3	-5.2	3.6	6	8	0	-0.5	-1.4	6	8	0	-0.5	-1.4
1	7	8	21.9	21.2	5	7	3	-8.1	6.5	1	8	4	12.6	-12.1	6	8	1	12.3	-11.1	6	8	1	12.3	-11.1
1	7	9	-2.8	-3.4	5	7	4	20.0	-20.5	1	8	5	17.8	-15.1	6	8	2	-0.6	-0.9	6	8	2	-0.6	-0.9
1	7	10	-10.0	-9.4	5	7	5	-8.4	9.6	1	8	6	-0.5	4.5	7	8	-8	-6.1	1.8	7	8	-8	-6.1	1.8
2	7	-11	-2.8	-7.6	5	7	6	23.7	24.2	1	8	7	18.1	17.9	7	8	-7	-6.9	-7.7	7	8	-7	-6.9	-7.7
2	7	-10	19.9	17.5	6	7	-12	20.3	19.5	1	8	8	-0.5	0.5	7	8	-6	11.4	-11.7	7	8	-6	11.4	-11.7
2	7	-9	-8.8	-6.7	6	7	-11	-0.5	-4.8	2	8	-9	-0.5	-0.7	7	8	-5	16.6	-16.3	7	8	-5	16.6	-16.3
2	7	-8	18.3	-17.3	6	7	-10	23.4	-22.9	2	8	-8	-8.6	-10.1	7	8	-4	-7.9	13.8	7	8	-4	-7.9	13.8
2	7	-7	-4.7	-2.6	6	7	-9	-6.3	6.1	2	8	-7	12.5	-13.0	7	8	-3	20.3	20.3	7	8	-3	20.3	20.3
2	7	-6	-0.5	-1.8	6	7	-8	-0.5	-0.8	2	8	-6	15.7	15.0	7	8	-2	-5.3	1.5	7	8	-2	-5.3	1.5
2	7	-5	-0.5	-0.1	6	7	-7	10.2	8.6	2	8	-5	23.6	22.8	7	8	-1	11.4	-11.6	7	8	-1	11.4	-11.6
2	7	-4	-6.9	7.5	6	7	-6	20.4	20.0	2	8	-4	-5.7	-6.6	7	8	0	-5.2	-3.5	7	8	0	-5.2	-3.5
2	7	-3	18.0	18.8	6	7	-5	-9.3	-9.6	2	8	-3	26.5	-26.8	0	9	1	-7.5	-8.4	0	9	1	-7.5	-8.4
2	7	-2	17.2	-15.2	6	7	-4	20.4	-19.6	2	8	-2	-1.4	4.7	0	9	2	17.0	-16.1	0	9	2	17.0	-16.1
2	7	-1	-0.4	-0.4	6	7	-3	12.7	14.0	2	8	-1	19.2	-21.0	0	9	3	15.3	14.5	0	9	3	15.3	14.5
2	7	0	32.8	33.3	6	7	-2	-8.1	7.7	2	8	0	-8.5	9.5	0	9	4	11.6	9.6	0	9	4	11.6	9.6
2	7	1	-8.1	-8.6	6	7	-1	-1.9	1.2	2	8	1	16.1	17.6	0	9	5	-3.0	-4.8	0	9	5	-3.0	-4.8
2	7	2	-2.7	-3.9	6	7	0	15.5	15.0	2	8	2	21.9	-22.5	0	9	6	11.8	-9.9	0	9	6	11.8	-9.9
2	7	3	-0.5	-3.0	6	7	1	10.5	-8.4	2	8	3	11.5	-9.7	1	9	-6	22.0	-21.6	1	9	-6	22.0	-21.6
2	7	4	20.7	-20.9	6	7	2	21.0	-21.9	2	8	4	-6.1	2.8	1	9	-5	-0.5	1.5	1	9	-5	-0.5	1.5
2	7	5	-7.0	0.8	6	7	3	-4.7	-1.9	2	8	5	13.4	13.0	1	9	-4	-6.8	6.4	1	9	-4	-6.8	6.4
2	7	6	31.7	32.2	6	7	4	16.3	12.9	2	8	6	-0.5	0.2	1	9	-3	-5.4	-4.5	1	9	-3	-5.4	-4.5
2	7	7	-5.9	-8.7	6	7	5	11.6	-12.2	2	8	7	12.7	11.5	1	9	-2	10.1	9.8	1	9	-2	10.1	9.8
2	7	8	13.8	-14.0	7	7	-11	-7.2	-6.6	3	8	-10	11.4	-13.0	1	9	-1	-0.5	1.5	1	9	-1	-0.5	1.5
2	7	9	16.3	15.8	7	7	-10	-0.5	-5.2	3	8	-9	11.4	-12.0	1	9	0	17.9	-18.8	1	9	0	17.9	-18.8
3	7	-12	-9.1	10.1	7	7	-9	11.1	-7.9	3	8	-8	13.1	14.4	1	9	1	22.0	21.4	1	9	1	22.0	21.4
3	7	-11	-9.2	9.1	7	7	-8	21.9	21.8	3	8	-7	21.3	20.9	1	9	2	-9.6	5.6	1	9	2	-9.6	5.6
3	7	-10	-8.9	-4.3	7	7	-7	17.1	-17.5	3	8	-6	-8.0	-6.8	1	9	3	19.8	-19.8	1	9	3	19.8	-19.8
3	7	-9	10.6	6.9	7	7	-6	29.0	-28.6	3	8	-5	-0.5	1.6	1	9	4	15.3	-14.1	1	9	4	15.3	-14.1
3	7	-8	-4.6	3.6	7	7	-5	-0.5	-3.3	3	8	-4	-0.5	-3.7	1	9	5	-0.5	3.4	1	9	5	-0.5	3.4
3	7	-7	11.7	10.9	7	7	-4	14.2	14.0	3	8	-3	12.7	-12.7	2	9	-6	-7.3	7.4	2	9	-6	-7.3	7.4
3	7	-6	24.7	24.2	7	7	-3	15.3	14.5	3	8	-2	-0.5	0.7	2	9	-5	-7.9	-8.3	2	9	-5	-7.9	-8.3
3	7	-5	-4.2	4.1	7	7	-2	-6.4	8.3	3	8	-1	15.1	16.0	2	9	-4	17.4	16.7	2	9	-4	17.4	16.7
3	7	-4	38.6	-37.7	7	7	-1	13.0	12.9	3	8	0	-0.5	-0.6	2	9	-3	-8.2	-7.3	2	9	-3	-8.2	-7.3
3	7	-3	-5.4	1.0	7	7	0	20.0	-19.2	3	8	1	32.0	-31.6	2	9	-2	17.2	-18.6	2	9	-2	17.2	-18.6
3	7	-2	16.2	15.9	7	7	1	-8.9	-6.1	3	8	2	-4.6	-4.3	2	9	-1	-8.9	9.0	2	9	-1	-8.9	9.0
3	7	-1	8.8	8.2	7	7	2	-5.2	7.9	3	8	3	10.8	11.4	2	9	0	17.8	16.0	2	9	0	17.8	16.0
3	7	0	-3.0	-3.2	7	7	3	-6.7	-10.1	3	8	4	-0.5	-2.3	2	9	1	10.8	-12.0	2	9	1	10.8	-12.0
3	7	1	15.8	-14.6	8	7	-10	15.4	15.0	3	8	5	16.8	16.3	2	9	2	-6.5	-2.9	2	9	2	-6.5	-2.9
3	7	2	19.8	-19.1	8	7	-9	-0.5	2.1	3	8	6	18.3	-16.4	2	9	3	-8.6	8.5	2	9	3	-8.6	8.5
3	7	3	-7.4	-5.2	8	7	-8	11.8	-11.9	4	8	-10	11.3	12.9	2	9	4	-2.1	-1.0	2	9	4	-2.1	-1.0
3	7	4	28.1	26.4	8	7	-7	-0.5	4.5	4	8	-9	19.6	18.9	3	9	-6	12.7	13.9	3	9	-6	12.7	13.9
3	7	5	-7.4	6.1	8	7	-6	-5.2	7.6	4	8	-8	-2.5	-2.8	3	9	-5	-4.7	-6.0	3	9	-5	-4.7	-6.0
3	7	6	13.6	-12.3	8	7	-5	-4.0	9.7	4	8	-7	-0.5	1.8	3	9	-4	14.6	-14.0	3	9	-4	14.6	-14.0
3	7	7	-9.4	10.3	8	7	-4	-7.1	6.7	4	8	-6	-6.4	-6.6	3	9	-3	-7.7	4.3	3	9	-3	-7.7	4.3
3	7	8	12.1	-9.0	8	7	-3	10.7	11.0	4	8	-5	20.6	-20.5	3	9	-2	-1.7	-1.3	3	9	-2	-1.7	-1.3
4	7	-12	10.8	-11.5	8	7	-2	15.8	-14.4	4	8	-4	-0.5	3.7	3	9	-1	-0.5	7.3	3	9	-1	-0.5	7.3
4	7	-11	-0.5	-4.0	8	7	-1	-0.5	-5.5	4	8	-3	22.0	21.0	3	9	0	-8.3	-10.8	3	9	0	-8.3	-10.8
4	7	-10	-7.4	-5.9	8	7	0	-7.5	6.9	4	8	-2	17.4	18.2	3	9	1	-0.5	1.1	3	9	1	-0.5	1.1
4	7	-9	12.4	11.2	8	7	1	-0.6	5.8	4	8	-1	16.1	-16.2	3	9	2	12.0	-10.8	3	9	2	12.0	-10.8
4	7	-8	19.2	20.7	9	7	-9	-8.5	-11.2	4	8	0	-3.2	4.7	3	9	3	-9.6	8.8	3	9	3	-9.6	8.8
4	7	-7	-0.5	-1.8	9	7	-8	-5.3	-10.2	4	8	1	-5.6	6.3	4	9	-6	23.5	-23.2	4	9	-6	23.5	-23.2
4	7	-6	34.6	-33.6	9	7	-7	-0.5	-1.1	4	8													

CHAPTER FIVE

CHAPTER VTHE CRYSTAL AND MOLECULAR STRUCTURE OF AVO5.1 INTRODUCTION

The principal structural features found in AVO may be stated as follows:

The anion contains a vanadyl ion ($V = O$) with the metal atom coordinated to two oxalato groups and a water molecule. The vanadium atom is thus coordinated to six oxygen atoms and not five as previously suggested⁵.

The oxalato groups are aplanar and have a cis arrangement to one another. The bond lengths and angles in these groups correspond with those found in similar structures.

All the oxygen, nitrogen and hydrogen atoms in the molecule participate in hydrogen bonding.

5.2 THE STRUCTURE OF THE $[VO(C_2O_4)_2H_2O]^{2-}$ ANION

Fig. 5.1 gives a perspective view of the anion.

5.2.1 THE COORDINATION CAGE OF THE VANADIUM ATOM

The arrangement of the oxygen atoms may be described as that of a distorted octahedron. The departure from regularity was assessed by calculating mean planes and atomic deviations.

The general equation for the plane is $lX + mY + nZ - P = 0$ where X, Y and Z are the fractional coordinates in Å units with respect to the orthogonal axes a, b and c*, and P is the origin to plane distance in Å units.

The results for the three planes are given in Table 5.1.

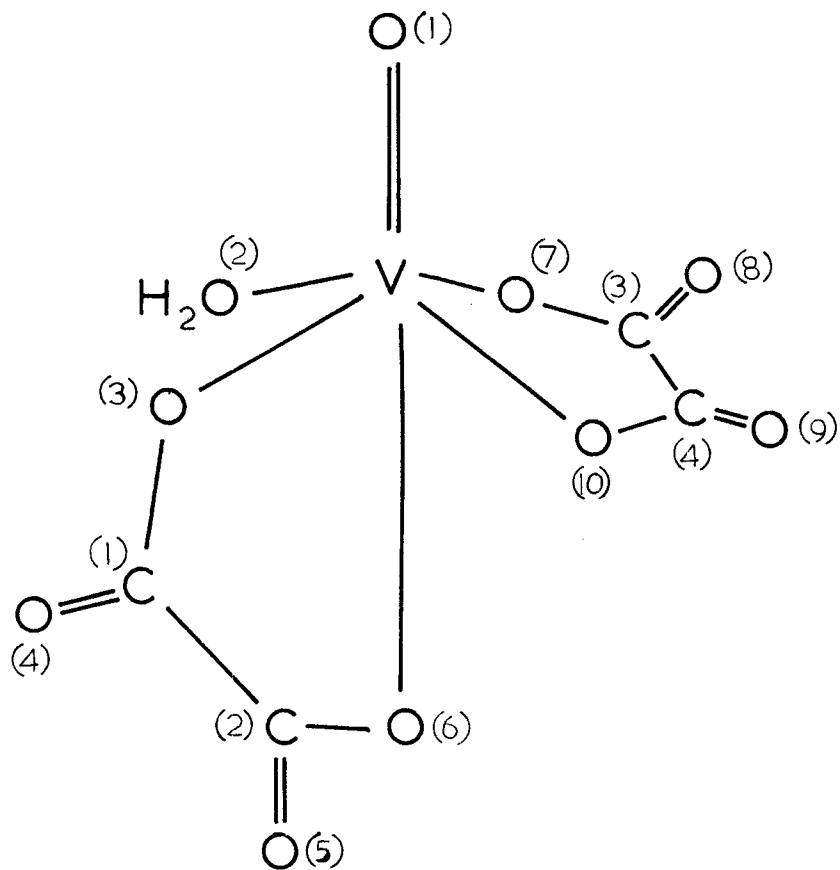

FIG. 5.1

The vanadium atom is displaced from the equatorial plane in the direction of the vanadyl oxygen O(1) by a distance of 0.302(1) Å. Scheidt et al¹⁵ found that in the case of the $[\text{VO}_2(\text{C}_2\text{O}_4)_2]^{3-}$ anion, it was displaced by approximately 0.40 Å from the effective octahedral centre towards the pair of OXO ligands.

The atoms O(1), V and O(6) are not colinear, the enclosed angle being 171°.

5.2.2 INTERATOMIC DISTANCES AND BOND ANGLES IN THE OCTAHEDRON

These parameters are given in tables 5.2 and 5.3

The bonds in the octahedron may be distinguished as follows:

- (a) the short apical vanadyl bond, V = O.
- (b) the long apical bond in the trans position.
- (c) the equatorial bonds.

The lengths of these bonds found in AVO, are compared in table 5.4 with those reported for other octahedral complexes.

The length of the V = O bond in AVO is 1.594(3) Å and agrees, within the limits of experimental error, with those in table 5.4. In particular it corresponds closely with the distance of 1.591(11) Å found for $\text{VO}(\text{C}_7\text{H}_3\text{NO}_4) \cdot 4\text{H}_2\text{O}$ ¹⁴.

Similarly the length of the apical bond V - O (6) is in good agreement with the other values in the table. Its length is much greater than those of the equatorial bonds, due to the trans influence of the V = O bond (see section 5.2.4).

The V - O equatorial bonds range in value from 1.985(3) to 2.033(3) Å. The longest distance is to the water oxygen O(2) whereas the remaining three shorter distances involve oxalato oxygens.

Bersted et al¹⁴ noted a similar relationship in the case of vanadyl (IV) pyridine 2.6 dicarboxylate tetrahydrate.

There is in general good agreement among the equatorial bond lengths in the compounds listed in the table.

Comparison may be made with five-coordinate square pyramidal monoxocomplexes. Vanadyl bisacetylacetonate⁹ which has a symmetrical molecule, has the bond lengths (Å)

(a) Apical V = O bond	1.56(1)
(b) Basal plane V - O bonds	1.97(1), 1.96(1)
	1.98(1), 1.96(1)

However in tetrasodiumdivanadyl (IV)-dl-tartrate¹³ they are,

(a) Apical V = O bond	1.619(7)
(b) Basal plane V - O bonds	2.004(6), 1.994(6)
	1.917(6), 1.902(6)

Table 5.5 compares the length of the V = O bond in five and six coordinate vanadyl compounds. It also shows that the length of this bond is considerably greater in the dioxocomplexes.

5.2.3 OXYGEN-OXYGEN DISTANCES

The two shortest distances in the octahedron are the "bites" of the oxalato groups. This is in agreement with the corresponding interatomic distances in the octahedral $[\text{VO}_2 (\text{C}_2\text{O}_4)_2]^{3-}$ anion¹⁵, which are given in parenthesis.

(a) equatorial - apical chelation:

O(3) to O(6)	2.567(4), [2.581(3)]
--------------	----------------------

(b) equatorial chelation:

O(7) to O(10)	2.599(4), [2.587(3)]
---------------	----------------------

Scheidt et al¹⁵ have pointed out that these distances are much shorter than the accepted van der Waals packing diameter of oxygen atoms (2.8 Å). The separations of the other pairs of oxygen atoms in the oxalato groups correspond with this value. The O(4) to O(5) distance is 2.823(4) and the O(8) to O(9) distance is 2.795(5) Å.

The abnormally short distances between the chelated oxygen atoms may be partly responsible for the inequality in the bond angles about the axis of the C - C links. (See table 5.9)

5.2.4 THE TRANS INFLUENCE OF THE VANADYL GROUP

The two axial bonds have markedly different lengths. The short vanadyl bond is strong and is considered to be a multiple bond. On the other hand the greater length of the bond to the other apical oxygen can be ascribed to the trans influence of the V = O bond. Ligands in this position are comparatively easily detached in accordance with the well known trans effect.

5.3.1 THE STEREOCHEMISTRY OF THE OXALATO GROUPS

Each oxalato group contributes two oxygen atoms to the coordination cage. It was previously supposed that the pairs of oxygens would be situated trans to one another at the corners of the basal plane of a square pyramidal structure. However, the present work shows that in fact the oxalato groups take up a cis arrangement in an octahedron.

This disposition may be a consequence of the mode of formation of the compound. In a discussion of six coordinated complexes of the transition metals, Stranks⁶⁵ states, "In water, aquation invariably precedes substitution by anions" and he reviews the supporting experimental evidence.

In the formation of complex vanadyl (IV) oxalates in aqueous solution, we may thus regard the attachment of ligands as a process which replaces coordinated water molecules in the complex aquo ion shown in Fig. 5.2

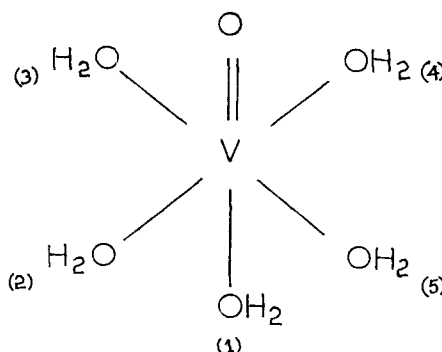

FIG. 5.2

Owing to the trans effect, substitution by a single bidentate oxalato ligand may be expected to replace the water molecules in positions (1) and (2). Substitution by a second oxalato group can now only occur by replacement of two water molecules in the equatorial plane.

Ballhausen and Gray⁶⁰ state that, "the accumulated spectral and magnetic evidence strongly support the assumption that the vanadyl ion actually retains its VO^{2+} identity in solution and is surrounded by water molecules to complete a distorted octahedral array". The water molecule in the trans position would be the weakest ligand and the mode of substitution of the oxalato groups which has been proposed, would appear to be feasible.

Sathyanarayana et al⁵ prepared vanadyl monoxalate tetrahydrate

and, on the basis of thermal and spectral data, proposed the structure in Fig. 5.3

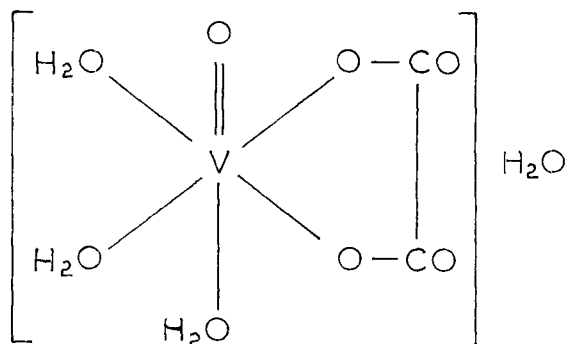

FIG. 5.3

They considered that the oxygens around the vanadium atom form a distorted octahedron, with a weakly bonded water molecule occupying the apical position trans to the vanadyl group. On the basis of the previous discussion a more probable configuration is that given in Fig. 5.4

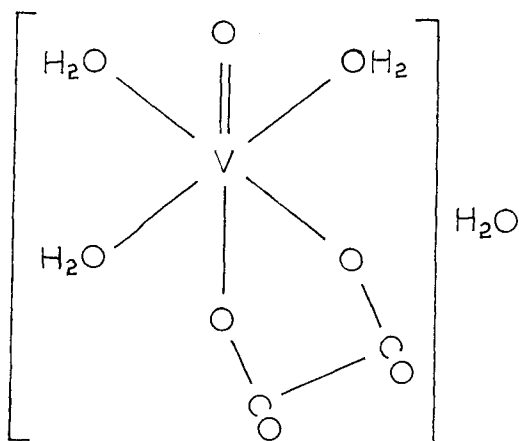

FIG. 5.4

It may be noted that the $[\text{VO}_2(\text{C}_2\text{O}_4)_2]^{3-}$ anion (Fig.1.5) has the cis configuration as in AVO , but this is a necessary consequence of the fact that one of the vanadyl oxygens occupies an equatorial position.

In $(\text{NH}_4)_2 [\text{VO}(\text{NCS})_4 \cdot \text{H}_2\text{O}] \cdot 4\text{H}_2\text{O}$ ¹¹ the coordinated water molecule is trans to the vanadyl oxygen. The four isothiocyanato ligands occupy the equatorial positions which would seem better suited to the strong π bonding with the metal atom.

5.3.2 THE APLANARITY OF THE OXALATO GROUPS

The mean planes and deviations of the atoms constituting the oxalato groups, are given in Tables 5.6 and 5.7.

These results show that the planes of the carboxyl groups are twisted by 10.0° about the axis of the C(1) - C(2) bond and by 12.8° about the axis of the C(3) - C(4) bond.

An examination of the published work (Chap. I) on complex oxalates shows that, as with simple oxalates the group may have a planar or aplanar configuration. Indeed in the case of triammonium bisoxalatodioxovanadate (V) dihydrate (ADVO)¹⁵ one oxalato group is planar but the other, the authors state, departs appreciably from planarity as a consequence of the folding of the edge of the coordination polyhedron. The dihedral angle between the carboxyl groups is not given.

It is possible that the distortions of the angles of the polyhedron are partly due to the requirement of planarity in the C - COO groups. If the carboxyl planes can be twisted as a consequence of hydrogen bonding as stated by Robertson²⁵, then this would necessarily cause some irregularity in the octahedron.

Table 5.8 gives the references of published structures, classified in accordance with the stereochemistry of their oxalato groups.

5.3.3 BOND LENGTHS AND ANGLES IN THE OXALATO GROUPS

The structural parameters of the oxalato groups are shown in Fig. 5.5.

The bond lengths and angles correspond generally with those found in both complex and simple compounds. Kuppers³² has presented tabulated data for acid oxalates and Hodgson and Ibers³⁰ have compiled data for oxalic acid and its salts.

Table 5.9 compares the bond lengths and angles found in complex oxalates and in some simple oxalates. In the case of the complexes, the bonds attaching to the coordinated oxygens (O_c) and uncoordinated oxygens (O_u) are distinguished. In the table the parameters given are simple averages of bond lengths and angles of the same type. Discussion of the individual values in AVO is deferred to section 5.3.4.

Hahn⁶⁹ stated that a fully ionised carboxyl group should have equal C - O bonds of 1.260 Å enclosing an angle of 125° and making equal angles of 117.5° with the C - C bond. The table shows that in general, the simple oxalates tend to correspond more closely with Hahn's values. In the case of AVO there is a difference in the average lengths of the C - O_c and C - O_u bonds of 0.051(5) Å. This difference is approximately the average value of those pertaining to the complex oxalates listed. However the overall average (1.249 Å) agrees with Hahn's value. As with most oxalates, the enclosed angle (125.4°) corresponds well, the largest deviations being in the angles which the two bonds make with the C - C link.

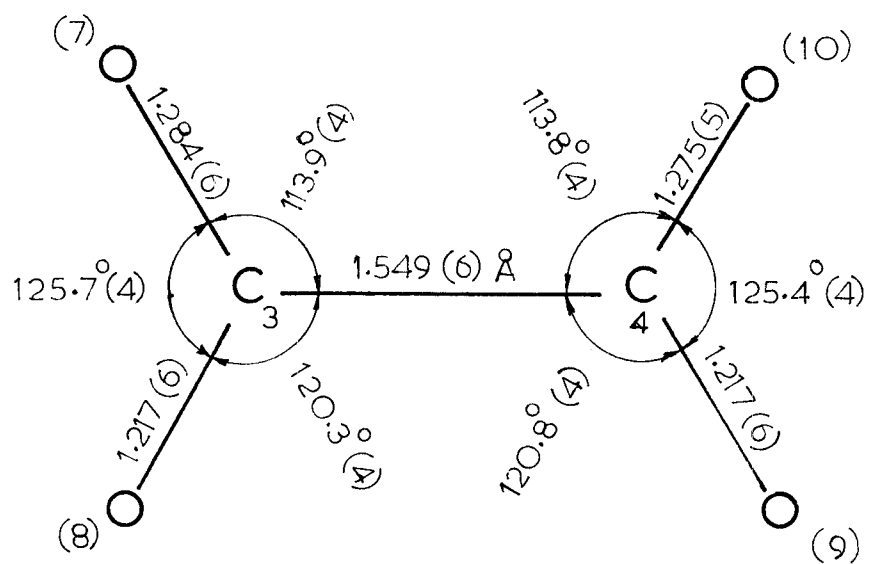
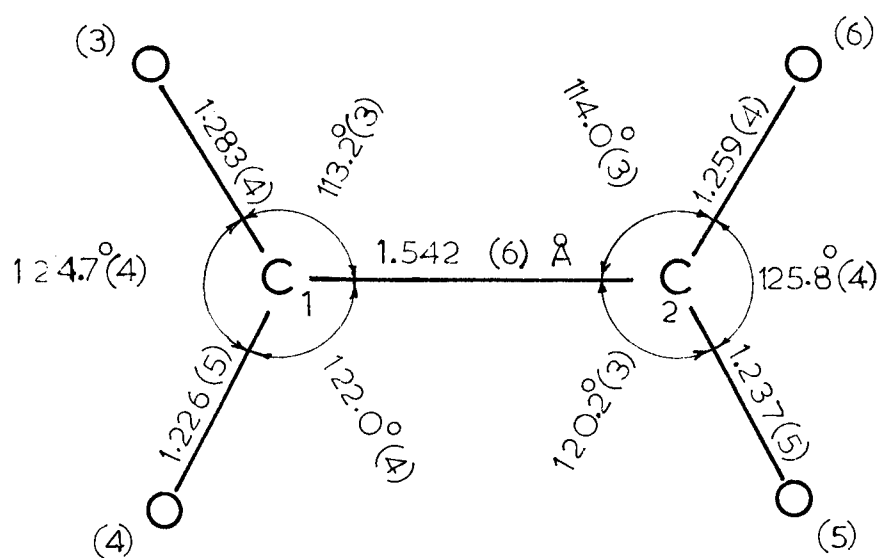

FIG. 5.5

The C - C bond lengths in the oxalate groups in AVO correspond to the simple type of bond to which Sutton⁷⁰ has assigned a value of $1.537 \pm 0.005 \text{ \AA}$. They also agree closely with the accepted bond length in diamond (1.544 \AA). The length of this bond in AVO ($1.542(6) \text{ \AA}$, $1.549(6) \text{ \AA}$), agrees closely with the average value (1.552 \AA), found in the other complex oxalates listed in the table.

The environment of the carbon atoms suggests that these two atoms are in sp^2 hybrid states. However a $C_{(sp^2)} - C_{(sp^2)}$ bond has a length which has been variously estimated as from 1.47 to 1.51 \AA , which is significantly shorter than that found in AVO and other oxalates. It has been found however, that when the carbon atoms are attached to oxygens, a considerably lengthening of the bond may occur. Kuchitsu, Fukuyama and Morino showed that in the series, butadiene, acrolein, glyoxal the $C_{(sp^2)} - C_{(sp^2)}$ bond length was 1.463, 1.482 and 1.525 \AA respectively.

Brown and Harcourt⁷² have studied various A_2B_4 systems such as C_2O_4 and N_2O_4 , using the molecular orbital theory and they suggest that the expected C - C bond length in oxalates should be slightly longer than that in ethane (1.534 \AA) and have a sigma bond order of 0.93.

It has been pointed out by Robertson²⁵ that in simple oxalates, there is no connection between planarity and the length of this bond. The parameters of the complex oxalates previously discussed, suggests that this also applies to them. Haas²⁷ found that in potassium tetroxalate $K(HC_2O_4)(H_2C_2O_4) \cdot 2H_2O$, this bond had the same length in both the planar oxalic acid molecules and the aplanar acid oxalate groups.

5.3.4 THE TRANS INFLUENCE IN RELATION TO BOND LENGTHS IN THE OXALATO GROUPS

As a consequence of the trans influence, the V - O(6) bond is long and an examination of the dimensions of the oxalato groups indicates that the C - O bond lengths are also affected.

The C - O_c bond lengths (Å) are as follows:

C(2) - O(6)	1.259(4) Å
C(1) - O(3)	1.283(4)
C(3) - O(7)	1.284(6)
C(4) - O(10)	1.275(5)

Thus the C - O distance involving the oxygen in the trans position, is the shortest by a significant margin. In particular it is 0.024 Å shorter than the other C - O_c bond in the same oxalato group.

When the ring comprising the atoms V, O(6), C(2), C(1) and O(3) is considered, an alternation occurs of longer and shorter bonds, in a comparative sense, within the two carboxyl groups. We have the following bond lengths:

(a) V	<u>2.184(3)</u> O(6)	<u>1.259(4)</u> C(2)	<u>1.237(5)</u> O(5)
	(trans)		
(b) V	<u>2.022(3)</u> O(3)	<u>1.283(4)</u> C(1)	<u>1.226(5)</u> O(4)

On the other hand, when we examine the corresponding bond lengths in the ring which is not involved in the trans effect we have:

(a) V	<u>1.985(3)</u> O(7)	<u>1.284(6)</u> C(3)	<u>1.217(6)</u> O(8)
(b) V	<u>2.006(3)</u> O(10)	<u>1.275(5)</u> C(4)	<u>1.217(6)</u> O(9)

These C - O bond lengths match reasonably well.

This pattern, which appears to be a consequence of the trans influence, was also found in ADV0 by Scheidt et al¹⁵. Table 5.10 compares their C - O bond lengths, differentiating between those which involve oxygens in the trans position and those which do not. The C - O_c (trans) bond is shorter than the other three C - O_c distances, which are the same within the limits of experimental error. The C - O_u bond adjacent to the C - O_c (trans) bond is longer than the other three C - O_u distances, which are also the same within the limits of experimental error. The same effect is found in ADV0 when appropriate pairs are considered.

Thus by taking into account the trans influence, the lengths of corresponding C - O bonds are seen to be the same within the limits of error.

Included in the Table are the corresponding parameters for K₂ [MoO (O₂)₂ (C₂O₄)]⁶⁶ and Na NH₄ [MoO₃ (C₂O₄)] · 2H₂O⁶⁷. In the former case a Mo = O bond (1.678 Å) exerts a trans influence and the parameters given, though not of the highest accuracy, indicate that this OXO group may also modify the bond lengths in the oxalato chelate.

The [MoO₃ (C₂O₄)]²⁻ anion has an equatorial plane which has the metal atom at the centre, the four corners being occupied by oxygens. Two terminal oxygens are in the cis position and are linked to the metal atom by short M = O bonds (1.850, 1.815 Å) and the two remaining equatorial positions are occupied by the bidentate oxalato group. Thus the trans influence can be expected to occur along both diagonals of this plane producing the two longest bonds in the octahedron (2.235, 2.242 Å). Because of the equal

lengths of these bonds it would be expected that the lengths of the pairs of C - O_c (trans) and of the pairs of C - O_u would also be the same. This is, in fact, the case.

Reference to Tables 5.9 and 5.10 shows that the C - O_c and C - O_u lengths found in this molybdenum compound, differ significantly from typical values. This is possibly a consequence of what may be termed a multiple trans influence, as distinct from a simple trans influence. It may also be noted that the C - C bond is short compared with that of the other oxalates listed in Table 5.9.

5.4 THE AMMONIUM IONS

The four hydrogen atoms bonded to each of the nitrogen atoms form a distorted tetrahedron. In the case of N(1) the N - H bond lengths range from 0.843 to 0.968 Å. The tetrahedral angles about the nitrogen atom range from 103 to 118°. The N(2) - H bond lengths are from 0.805 to 0.934 Å and the tetrahedral angles from 103 to 122°. (See Table 5.11).

"Kuppers³², in an accurate determination of the structure of ammonium hydrogen oxalate hemihydrate, found that the N - H distances and O - H distances ranged from 0.83 to 0.99 Å. As may be expected the N - H distances are shorter than those determined by neutron diffraction methods. Thus Currie et al²⁶ found that the length of this bond in ammonium tetraoxalate is 1.009 Å.

The nitrogen atom N(1) has six oxygen atoms within a radius of 3.1 Å and two further oxygen atoms within 3.3 Å.

Atom N(2) also has six close neighbours within 3.104 Å. (See Table 5.12).

5.5 THE WATER MOLECULES

One of the water molecules, H(11), O(2), H(12) is a ligand of the vanadium atom and the other, H(9), O(11), H(10) is lattice water.

The anion is therefore correctly formulated as,

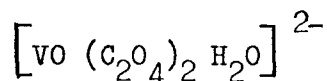

and the compound AVO as,

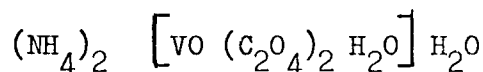

The coordinated water oxygen O(2) has six oxygen atoms as close neighbours and four of these are coordinated to the vanadium atom.

The lattice water oxygen O(11) has five atoms within 3.104 Å and a further oxygen atom at 3.227(4) Å.

Table 5.12 lists the atoms which make close approaches to the nitrogen and the water oxygen atoms. The superscripts give the equivalent position of the atom in accordance with the appended symmetry code.

Atoms O(11^I), O(1^{III}), O(6^{VI}) and N(2^I) are almost coplanar O(1^I) having the greatest deviation from the mean plane (-0.10 Å). Nitrogen atoms N(1^I) and N(2^{VIII}) lie on opposite sides of this plane at distances of 2.91 and -3.17 Å respectively.

5.6 MOLECULAR PACKING AND HYDROGEN BONDING IN THE STRUCTURE

The molecular packing of AVO as viewed down the b axis of the cell is shown in Fig. 5.6.

The four atoms which generate hydrogen bonds lie approximately on a plane as follows:

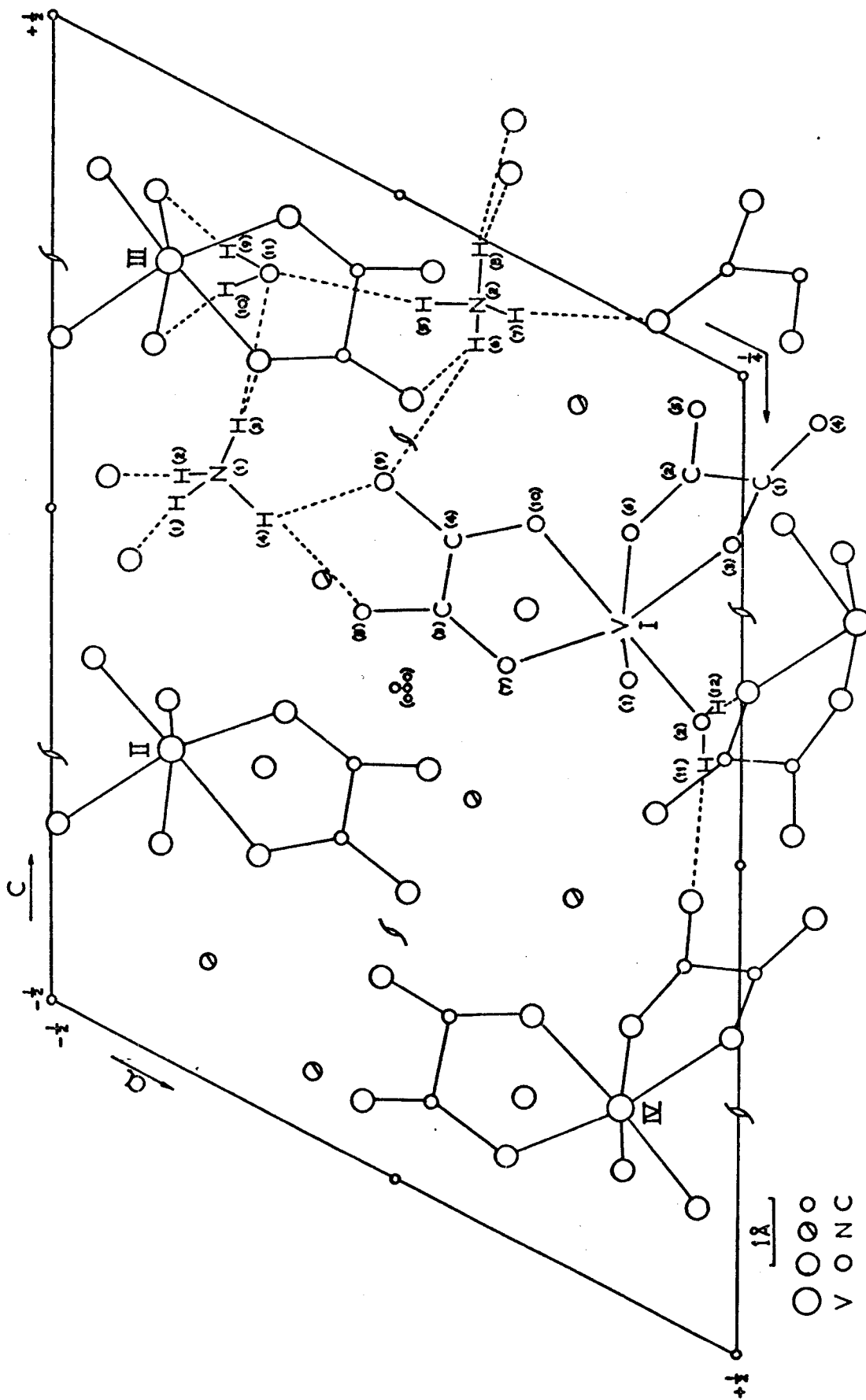

FIG. 5.6

Equation of mean plane:

$$0.0523X - 0.9867Y - 0.1539Z + 1.4815 = 0$$

Atomic deviations:

O(2)	0.0387(3)	N(1)	- 0.0688(3)
O(11)	0.1283(3)	N(2)	- 0.0982(4)

The twelve hydrogen atoms associated with the two ammonium ions and the two water molecules, form a complex network of hydrogen bonds, involving all the oxygen atoms, both coordinated and uncoordinated. As a result the anions in different asymmetric units are linked together via the ammonium ions and water molecules. They also serve to link together ions in adjacent unit cells, thus giving rise to a three dimensional network throughout the crystal.

The hydrogen bonding parameters are given in Table 5.13.

Hydrogen atoms H(3) and H(4) which are attached to N(1) form bifurcated bonds. Hydrogen atom H(8) attached to N(2) appears to form an unsymmetrical bond.

The nitrogen atom N(2) is at a suitable distance from O(9^I) for hydrogen bonding to occur but the enclosed angle is small. A more favourable angle exists with respect to O(9^{III}) but the distance between these two atoms is longer than would be expected. Thus the postulation of a bifurcated bond is much less certain in this case.

There are two types of hydrogen bond in the structure:

(a) N - H ······ O bonds

This type of bond involves some of the coordinated and some of the uncoordinated oxalato oxygens. The two ammonium ions are linked together by bonds of this type attaching to the water oxygen, O(11).

The average length of these bonds associated with N(1) is 2.961 Å

and that of the bonds associated with N(2) is 3.082 Å. These values are in reasonable agreement with those found in ammonium tartrate⁷³ (2.87 and 2.98 Å), ammonium tetroxalate²⁶ (2.947 Å) and ADVO (2.863, 2.863 and 2.896 Å).

(b) O - H ······ O bonds

The bond lengths in AVO vary over a considerable range (2.62 to 3.06 Å). This was also found in the case of ammonium tetroxalate where they ranged from 2.47 to 2.90 Å. The average length of these bonds in AVO is 2.829 Å and this value is in agreement with that found in ADVO (2.877 Å).

5.7 SUMMARY

The structural details of the AVO anion show that it is monomeric and that the vanadium atom is coordinated to six oxygens, (including a water oxygen), which form a distorted octahedron. The two oxalato groups, which are coordinated to the metal atom, have carboxylate planes which are twisted with respect to one another.

It is suggested that the cis arrangement of the oxalato groups may be a consequence of the trans effect of the vanadyl ion.

The deviations from geometric regularity in the octahedron and from planarity in the oxalato groups, may possibly be due to the effects of hydrogen bonding forces. However there is evidence which suggests that the lengths of the bonds in the octahedral complexes of vanadium, tend to have specific values. This factor, combined with the evident requirement of planarity in the C - CO₂ groups, may also play a part in determining the nature of the distortions in the structure of the anion.

The general stereochemical features of the oxalato groups agree

with those found in similar structures. Evidence has been presented which supports the view that the trans influence may affect the C - O bond lengths in chelated oxalato groups.

The water molecules and ammonium ions generate a network of hydrogen bonds in which all the oxygen atoms are involved.

TABLE 5.1MEAN PLANESEquation of the equatorial plane:

$$0.2424X - 0.8349Y - 0.4942Z - 1.115 = 0$$

Atomic deviations and their e.s.d. (Å)

O(2)	0.069 (3)	O (7)	- 0.076 (3)
O(3)	- 0.068 (2)	O(10)	0.076 (3)
V	0.302 (1)		

Equation of diagonal plane I:

$$0.8084X + 0.4595Y - 0.3679Z - 1.2123 = 0$$

Atomic deviations:

O(1)	0.051 (3)	O (6)	0.056 (3)
O(3)	- 0.057 (3)	O (7)	- 0.050 (3)
V	0.030 (1)		

Equation of diagonal plane II:

$$- 0.498X + 0.3420Y - 0.7965Z - 2.9788 = 0$$

Atomic deviations:

O(1)	- 0.121 (3)	O (6)	- 0.113 (2)
O(2)	0.118 (3)	O(10)	0.116 (3)
V	0.024 (1)		

TABLE 5.2INTERATOMIC DISTANCES

ATOMS	LENGTH (Å)	ATOMS	LENGTH (Å)
V - O (1)	1.594 (3)	O (2) - O (7)	2.871 (5)
V - O (2)	2.033 (3)	O (3) - O (1)	2.704 (4)
V - O (3)	2.022 (3)	O (3) - O (10)	2.883 (4)
V - O (6)	2.184 (3)	O (3) - O (6)	2.567 (4)
V - O (7)	1.985 (3)	O (10) - O (1)	2.729 (4)
V - O (10)	2.006 (3)	O (10) - O (7)	2.599 (4)
O (2) - O (3)	2.896 (4)	O (10) - O (6)	2.814 (4)
O (2) - O (6)	2.798 (4)	O (7) - O (1)	2.860 (4)
O (2) - O (1)	2.700 (4)	O (7) - O (6)	2.776 (3)

TABLE 5.3BOND ANGLES

ANGLE	DEGREES	ANGLE	DEGREES
O (1) - V - O (2)	95.49 (14)	O (6) - V - O (10)	84.27 (11)
O (1) - V - O (3)	96.09 (13)	O (6) - V - O (2)	83.06 (11)
O (1) - V - O (6)	171.02 (13)	O (6) - V - O (3)	75.12 (10)
O (1) - V - O (7)	105.57 (13)	O (7) - V - O (10)	81.27 (11)
O (1) - V - O (10)	97.97 (13)	O (3) - V - O (10)	91.44 (11)
O (6) - V - O (7)	83.34 (11)	O (2) - V - O (3)	91.19 (11)
		O (2) - V - O (7)	91.20 (12)

TABLE 5.4

BOND LENGTHS (\AA) IN OCTAHEDRAL VANADIUM COMPLEXES

COMPOUND	APICAL	APICAL (TRANS)	EQUATORIAL
	V = O	V - O	V - O
AVO	1.594(3)	2.184(3)	2.033 (3) 2.022 (3) 1.985 (3) 2.006 (3) av. = 2.011
VO SO ₄ ⁶²	1.59 (4)	2.28 (4)	2.00 (5) 2.01 (6) 2.05 (6) 2.05 (6) av. = 2.03 V - N
(NH ₄) ₂ VO(NCS) ₄ 5H ₂ O ¹¹	1.62 (6)	2.22 (5) V - N	2.04 (3) V - O
VO C ₇ H ₃ NO ₄ · 4H ₂ O ¹⁴	1.591 (11)	2.184 (2)	2.027 (12) 2.027 (12) 2.017 (10) 2.017 (10) av. = 2.022

TABLE 5.5

VANADYL BOND LENGTHS

COMPOUND	BOND LENGTH (Å)	COORDINATION NO. OF VANADIUM	REF.
$(\text{NH}_4)_2 [\text{VO}(\text{C}_2\text{O}_4)_2 \cdot \text{H}_2\text{O}] \cdot \text{H}_2\text{O}$	1.594 (3)	6	This Work
$\text{VOSO}_4 \cdot 5\text{H}_2\text{O}$	1.67	6	8
VOSO_4	1.59 (4)	6	62
$(\text{NH}_4)_2 \text{VO}(\text{NCS})_4 \cdot 5\text{H}_2\text{O}$	1.62 (6)	6	11
$\text{VO}(\text{C}_7\text{H}_3\text{O}_4\text{N})_4 \cdot 4\text{H}_2\text{O}$	1.591 (11)	6	14
$\text{VO}(\text{C}_6\text{H}_5\text{COCHCOCH}_3)_2$	1.612 (10)	5	63
$\text{VO}(\text{CH}_3\text{COCHCOCH}_3)_2$	1.56 (1)	5	9
$\text{Na}_4(\text{VO-dl-c}_4\text{H}_2\text{O}_6)_2 \cdot 12\text{H}_2\text{O}$	1.619 (7)	5	13
$(\text{NH}_4)_2 \text{VO}(\text{a-c}_4\text{H}_2\text{O}_6) \cdot \text{H}_2\text{O}$	1.60 (2)	5	12
$(\text{NH}_4)_3 [\text{VO}_2(\text{C}_2\text{O}_4)_2] \cdot 2\text{H}_2\text{O}$	1.641 (2)	6	15
$\text{Na}_3 [\text{VO}_2\text{EDTA}] \cdot 4\text{H}_2\text{O}$	1.648 (2)	6	64

TABLE 5.6

MEAN PLANES IN OXALATO GROUPEquation of Mean Plane for C(1), C(2), O(3), O(4), O(5), O(6)

$$0.8119X + 0.5495Y - 0.1973Z - 1.9607 = 0$$

Atomic deviations:

C(1)	- 0.007 (4)	0 (4)	0.095 (3)
------	-------------	-------	-----------

C(2)	0.000 (4)	0 (5)	- 0.091 (3)
------	-----------	-------	-------------

O(3)	- 0.097 (3)	0 (6)	0.102 (3)
------	-------------	-------	-----------

Equation of Mean Plane for C(1), C(2), O(3), O(4)

$$0.8051X + 0.5229Y - 0.2799Z - 1.4996 = 0$$

Atomic deviations:

C(1)	- 0.007 (4)	0 (3)	0.002 (3)
------	-------------	-------	-----------

C(2)	0.002 (4)	0 (4)	0.003 (3)
------	-----------	-------	-----------

Equation of Mean Plane for C(1), C(2), O(5), O(6)

$$0.8140X + 0.5699Y - 0.1123Z - 2.4084 = 0$$

Atomic deviations:

C(1)	- 0.000 (4)	0 (5)	- 0.000 (3)
------	-------------	-------	-------------

C(2)	0.001 (4)	0 (6)	- 0.000 (3)
------	-----------	-------	-------------

TABLE 5.7MEAN PLANES IN OXALATO GROUPEquation of Mean Plane for C(3), C(4), O(7), O(8), O(9), O(10)

$$0.0331X - 0.7330Y - 0.6794Z - 1.6385 = 0$$

Atomic deviations:

C(3)	- 0.002 (4)	O (8)	- 0.119 (3)
C(4)	0.012 (4)	O (9)	0.115 (3)
O(7)	0.128 (3)	O (10)	- 0.133 (3)

Equation of Mean Plane for C(3), C(4), O(7), O(8)

$$-0.0741X - 0.7107Y - 0.6996Z - 1.6367 = 0$$

Atomic deviations:

C(3)	- 0.003 (3)	O (7)	0.001 (2)
C(4)	0.001 (4)	O (8)	0.001 (3)

Equation of Mean Plane for C(3), C(4), O(9), O(10)

$$0.1427X - 0.7415Y - 0.6556Z - 1.6200 = 0$$

Atomic deviations:

C(3)	- 0.003 (4)	O (9)	- 0.004 (3)
C(4)	0.010 (4)	O (10)	- 0.004 (3)

TABLE 5.8

PLANARITY OF COMPLEX OXALATES

COMPOUND	PLANAR	APLANAR
AVO		This Work
ADVO	15	15
$K_2[MoO(O_2)_2(C_2O_4)]$		66
$(NH_4)_2[Cu(C_2O_4)_2(H_2O)_2]$		35
$Na_4Zr(C_2O_4)_4 \cdot 3H_2O$	37	
$K[Cr(C_2O_4)_2(H_2O)_2] \cdot 3H_2O$	34	
$Na_2(C_2O_4)_3 \cdot 10.5 H_2O$	36	
$CS[NbO(C_2O_4)_2(H_2O)_2] \cdot 2H_2O$	67	
$[UO_2(C_2O_4) \cdot 3H_2O]$	40	

TABLE 5.2
 (AVERAGE) BOND LENGTHS AND ANGLES IN COMPLEX AND SIMPLE OXALATES

COMPLEX OXALATES	BOND LENGTH (Å)				ANGLE (°)			REF.
	C-C	C-O _c	C-O _u	O-C-O _u	C-C-O _c	C-C-O _u	C-C-O _u	
(NH ₄) ₂ [VO(C ₂ O ₄) ₂ ·H ₂ O]·H ₂ O	1.545	1.275	1.224	125.4	113.7	120.8	This Work	
(NH ₄) ₃ [VO ₂ (C ₂ O ₄) ₂]·2H ₂ O	1.538	1.274	1.234	127.1	113.9	118.6	15	
Na ₄ Zr(C ₂ O ₄) ₄ ·3H ₂ O	1.545	1.275	1.222	126.3	113.4	120.2	37	
K ₂ [MoO(O ₂) ₂ (C ₂ O ₄)]	1.561	1.277	1.210	124.4	115.4	120.0	66	
Cu(NH ₄) ₂ (C ₂ O ₄) ₂ ·2H ₂ O	1.59	1.29	1.28	120	116	123	35	
Na(NH ₄) [MoO ₃ C ₂ O ₄]·2H ₂ O	1.525	1.360	1.260	125	115	121	68	
SIMPLE OXALATES	C-C	C-O(1)	C-O(2)	O(1)-C-O(2)	C-C-O(1)	C-C-O(2)		
Li ₂ C ₂ O ₄	1.559	1.257	1.247	127.1	116.4	116.5	69	
K ₂ C ₂ O ₄ ·H ₂ O	1.574	1.260	1.247	126.3	115.0	118.8	30	
(NH ₄) ₂ C ₂ O ₄ ·H ₂ O	1.569	1.252	1.263	126.0	117.5	116.5	25	
H ₂ C ₂ O ₄ ·2H ₂ O	1.538	1.285	1.212	126.8	112.1	121.1	28	

TABLE 5.10

COMPARISON OF C - O BOND LENGTHS

COMPOUND	BOND LENGTH Å		
	C - C _c (trans)	C - O _c	C - O _u
$(\text{NH}_4)_2 [\text{VO} (\text{C}_2\text{O}_4)_2 \cdot \text{H}_2\text{O}] \cdot \text{H}_2\text{O}$	1.259(4)		1.237(5)
		1.283(4)	1.226(4)
		1.284(6)	1.217(6)
		1.275(5)	1.217(6)
		av. = 1.281	
$(\text{NH}_4)_3 [\text{VO}_2 (\text{C}_2\text{O}_4)_2] \cdot 2\text{H}_2\text{O}$	1.263(3)		1.239(3)
	1.262(4)		1.241(4)
	av. = 1.262	1.291(3)	1.221(3)
		1.280(4)	1.234(4)
		av. = 1.285	
$\text{K}_2 [\text{MoO} (\text{O}_2)_2 (\text{C}_2\text{O}_4)]$	1.266(20)		1.213(23)
		1.287(23)	1.207(25)
$\text{NaNH}_4 [\text{MoO}_3 (\text{C}_2\text{O}_4)] \cdot 2\text{H}_2\text{O}$	1.360(8)		1.260(8)
	1.360(8)		1.260(8)

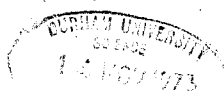

TABLE 5.11

BOND LENGTHS AND ANGLES IN THE AMMONIUM IONS AND WATER MOLECULES

ANGLE	DEGREES	BOND	LENGTH (Å)
H(1)-N(1)-H(2)	110	N(1)-H(1)	0.968
H(1)-N(1)-H(3)	103	N(1)-H(2)	0.852
H(1)-N(1)-H(4)	110	N(1)-H(3)	0.843
H(2)-N(1)-H(3)	118	N(1)-H(4)	0.915
H(2)-N(1)-H(4)	110		
H(3)-N(1)-H(4)	106		
H(5)-N(2)-H(6)	104	N(2)-H(5)	0.805
H(5)-N(2)-H(7)	122	N(2)-H(6)	0.867
H(5)-N(2)-H(8)	106	N(2)-H(7)	0.853
H(6)-N(2)-H(7)	108	N(2)-H(8)	0.934
H(6)-N(2)-H(8)	103		
H(7)-N(2)-H(8)	112		
H(11)-O(2)-H(12)	101	O(2)-H(11)	0.812
		O(2)-H(12)	0.902
H(9)-O(11)-H(10)	96	O(11)-H(9)	0.897
		O(11)-H(10)	0.880

TABLE 5.12

CLOSE APPROACHES TO NITROGEN AND WATER OXYGEN ATOMS

ATOMS		DISTANCE O (Å)	ATOMS		DISTANCE O (Å)
N(1 ^I)	O(8 ^I)	2.979(5)	N(2 ^I)	O(9 ^I)	3.096(5)
	O(9 ^I)	2.887(5)		O(11 ^I)	3.016(6)
	O(11 ^I)	3.097(5)		O(4 ^{VII})	3.003(6)
	O(4 ^V)	2.828(4)		O(7 ^{IV})	2.893(5)
	O(5 ^{VI})	2.886(5)		O(8 ^{VI})	3.043(5)
	O(10 ^{III})	3.087(4)		O(11 ^{XIII})	3.104(5)
O(2 ^I)	O(3 ^X)	2.621(4)	O(11 ^I)	N(1 ^I)	3.097(5)
	O(5 ^{IX})	2.685(4)		N(2 ^I)	3.016(6)
	O(6 ^I)	2.798(4)		N(2 ^{VIII})	3.104(5)
	O(1 ^I)	2.700(4)		O(1 ^{III})	3.056(4)
	O(3 ^I)	2.896(4)		O(6 ^{VI})	2.955(4)
	O(7 ^I)	2.871(5)		O(8 ^{IV})	3.227(4)

EQUIVALENT POSITION	SYMMETRY CODE
x, y, z	I
$-x, -y, -z$	II
$-x, \frac{1}{2} + y, \frac{1}{2} - z$	III
$x, \frac{1}{2} - y, \frac{1}{2} + z$	IV
$-1 + x, \frac{1}{2} - y, -\frac{1}{2} + z$	V
$-x, -\frac{1}{2} + y, \frac{1}{2} - z$	VI
$1 - x, -y, 1 - z$	VII
$-x, -y, 1 - z$	VIII
$x, \frac{1}{2} - y, z - \frac{1}{2}$	IX
$1 - x, \frac{1}{2} + y, \frac{1}{2} - z$	X

TABLE 5.13

HYDROGEN BONDING PARAMETERS

BOND	DISTANCE BETWEEN HYDROGEN BONDED ATOMS (Å)	BOND ANGLE (°)
N(1 ^I) - H(1 ^I) - O(4 ^V)	2.828(4)	160.6
N(1 ^I) - H(2 ^I) - O(5 ^{VI})	2.886(4)	173.3
N(1 ^I) - H(4 ^I) - O(8 ^I)	2.979(5)	155.5
N(1 ^I) - H(4 ^I) - O(9 ^I)	2.887(5)	123.0
N(1 ^I) - H(3 ^I) - O(10 ^{III})	3.087(4)	138.9
N(1 ^I) - H(3 ^I) - O(11 ^I)	3.097(4)	132.2
N(2 ^I) - H(6 ^I) - O(9 ^I)	3.096(5)	91.8
N(2 ^I) - H(6 ^I) - O(9 ^{III})	3.379(5)	146.4
N(2 ^I) - H(5 ^I) - O(11 ^I)	3.016(6)	159.9
N(2 ^I) - H(7 ^I) - O(4 ^{VII})	3.003(6)	155.8
N(2 ^I) - H(8 ^I) - O(7 ^{IV})	2.893(5)	152.7
N(2 ^I) - H(8 ^I) - O(11 ^{VIII})	3.104(5)	114.3
O(2 ^I) - H(11 ^I) - O(5 ^{IX})	2.685(4)	171.4
O(2 ^I) - H(12 ^I) - O(3 ^X)	2.621(4)	167.2
O(11 ^I) - H(9 ^I) - O(1 ^{III})	3.056(4)	160.3
O(11 ^I) - H(10 ^I) - O(6 ^{VI})	2.955(4)	163.4

REFERENCES

- 1 Selbin J. (1964) *J. Chem. Educ.*, 41, 86.
- 2 Selbin J. (1965) *Chem. Revs.*, 2, 153.
- 3 Selbin J. (1966) *Coord. Chem. Revs.*, 1, 293.
- 4 Krishnamurty K.V., Harris G.M. (1961) *Chem. Revs.*, 61, 213.
- 5 Sathyanarayana D.N., Patel C.C. (1965) *J. Inorg. Nucl. Chem.*, 27, 297.
- 6 Byström A., Wilhelmi K.A., Brotzeno (1950) *Acta. Chem. Scand.*, 4, 1119.
- 7 Ketelaar, L.A.A. (1936) *Z. Krist.*, 95, 9.
- 8 Palma-Vitorelli M.B., Palma M.W., Pulumbo D., Sgarlata F. (1956) *Nuovo Cim.*, 3, 718.
- 9 Dodge R.P., Templeton D.H., Zalkin A. (1961) *J. Chem. Phys.* 35, 55.
- 10 Gillespie R.J. "Molecular Geometry", Van Nostrand Reinhold, (1972), p.194.
- 11 Hazell A.C., (1963) *J. Chem. Soc.*, 5745.
- 12 Forrest J.G., Prout C.K. (1967) *J. Chem. Soc. (A)*, 1312.
- 13 Tapscott R.E., Belford R.L., Paul J.C. (1968) *Inorg. Chem.* 7, 356.
- 14 Bersted B., Belford R.L., Paul J.C. (1968) *Inorg. Chem.*, 7, 1557.
- 15 Scheidt W.R., Chun-Che Tsai, Hoard J.L. (1971) *J. Amer. Chem. Soc.* 93, 3867 - 3872.
- 16 Zachariasen H.H. (1934) *Zeits f. Krist*, 91, 48.
- 17 Bride, Hermann and Peters (1942-43) *Ann. Physik*, 42, 3573.
- 18 Robertson and Woodward (1936) *J. Chem. Soc.*, 1817.
- 19 Dunitz J.D., Robertson J.M. (1947) *J. Chem. Soc.* 142.

- 20 Jeffrey G.A., Parry G.S. (1952) *J. Chem. Soc.* 4864.
- 21 Hendricks and Jefferson (1936) *J. Chem. Phys.*, 4, 102.
- 22 Cox E.G., Dougill M.W., Jeffrey G.A. (1952) *J. Chem. Soc.* 4854.
- 23 Ahmed F.R., Cruickshank D.W.J. (1953) *Acta Cryst.* 6, 385.
- 24 Jeffrey G.A., Parry G.S. (1954) *J. Amer. Chem. Soc.* 76, 5283.
- 25 Robertson J.H. (1965) *Acta Cryst.* 18, 410-417.
- 26 Currie M., Speakman J.C., Curry N.A. (1967) *J. Chem. Soc. (A)*
1862-1869.
- 27 Haas D.J. (1964) *Acta Cryst.* 17, 1511-1516.
- 28 Delaplane R.G., Ibers J.A. (1969) *Acta. Cryst.*, B25, 2423-2437.
- 29 Sabin T.H., Cox G.W., Craven B.M., (1969) *Acta. Cryst.* B25, 2487.
- 30 Hodgson D.J., Ibers J.A. (1969) *Acta. Cryst.* B25, 469-476.
- 31 Sequeira A., Srikanta S., Chidambaram R. (1970) *Acta. Cryst.*
B26, 77-80.
- 32 Küppers H. (1973) *Acta Cryst.* B29, 318-326.
- 33 Brown R.D., Harcourt R.D. (1963) *Aust. J. Chem.*, 16, 737-758.
- 34 van Niekerk J.N., Schoening F.R.E. (1951) *Acta. Cryst.* 4, 35-41.
- 35 Viswamitra M.A. (1962) *J. Chem. Phys.* 37, 1408-1414.
- 36 Hansson E. (1970) *Acta. Chem. Scand.*, 24, 2969.
- 37 Glen G.L. Silverton J.V., Hoard J.L. (1963) *Inorg. Chem.*
2, 250-256.
- 38 Cotton F.A., Morehouse S.M. (1965) *Inorg. Chem.*, 4, 1377-1381.
- 39 Alcock N.W. (1968) *Chem. Comm.*, 1327.
- 40 Jayadevan N.C., Chackraburttty D.M. (1972) *Acta. Cryst.* B28,
3178-3182.
- 41 Clark J.R. (1963) *Rev. Pure and Appd. Chem.*, 13, 50.

- 42 Hamilton W.C., Ibers J.A. Hydrogen Bonding in Solids,
W.A. Benjamin Inc. 1968 .
- 43 Vinogradov S.N. and Linnell R.H. Hydrogen Bonding, van
Nostrand Reinhold Co. (1971).
- 44 Baur W. (1964) Acta. Cryst., 17, 863.
- 45 Ferraris G. Franchini-Angela M., (1972) Acta. Cryst. B28, 3572.
- 46 Baur W.H. (1972) Acta. Cryst., B28, 1456.
- 47 Donahue J. Structural Chemistry and Molecular Biology.
W. H. Freeman & Co. (1968).
- 48 Oddo and Puxeddu (1906) Gazzetta, 36, ii, 1.
- 49 Koppel J., Goldmann R. (1903) Z. Anorg. Allg. Chem., 36, 281.
- 50 Palmer W.G. Experimental Inorganic Chemistry. University
Press (1954).
- 51 Sathyanarayana D.N., Patel C.C. (1966) J. Inorg. Nucl. Chem.
28, 2277.
- 52 Golding R.M. (1962) J. Mol. Phys., 5, 369.
- 53 Form G.R. (1968) Thesis, Newcastle upon Tyne Polytechnic.
- 54 Schmelz J. (1957) Spectrochimica Acta, 9, 51-58.
- 55 Fujita J. Nakamoto K., Kobayashi M. (1956) J. Amer. Chem.
Soc. 78, 3963-3965.
- 56 Barraclough C.G., Lewis J. Nyholm R.S. (1959) J. Chem. Soc. 3552.
- 57 Selbin J., Holmes L.H.Jr., McGlynn S.P. (1961) Chem. and Ind. 746.
- 58 Selbin J., Holmes L.H.Jr., McGlynn S.P. (1963) J. Inorg. Nucl.
Chem. 25, 1359.
- 59 Jorgensen C.K. (1957) Acta. Chem. Scand., 11, 73.
- 60 Ballhausen C.J. and Gray H.B. (1962) Inorg. Chem., 1, 111.

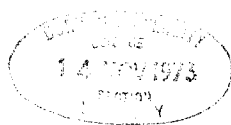

- 61 Monahan J.E., Schiffer M., Schiffer J.P. (1967) *Acta. Cryst.* 22, 322.
- 62 Kierkegaard P., Longo J.M. (1965) *Acta. Chem. Scand.*, 19, 1906.
- 63 Hon P.K., Belford R.L. Pflugger C.E. (1965) *J. Chem. Phys.* 43, 1323 .
- 64 Scheidt W.R., Countryman R., Hoard J.L. (1971) *J. Amer. Chem. Soc.*, 93:16, 3878-3882.
- 65 *Modern Coordination Chemistry.* Lewis J., Wilkins R.G., Interscience Publishers Inc. 1960.
- 66 Stomberg R., *Acta Chem., Scand.* (1970) 24, 2024-2036.
- 67 Atovmyan L.O., Bokii G.B. (1963) *Z. Strukt. Chim.*, 4, 524.
- 68 Beagley B., Small R.W.H. (1964) *Acta. Cryst.* 17, 783-788.
- 69 Hahn T. (1957) *Z. Kristallogr.* 109, 438.
- 70 Sutton L.E. *Interatomic Distances, Supplement Special Publication No. 18* (1965) The Chemical Society.
- 71 Kuchitsu K., Fukuyama T., and Morino Y. (1968) *J. Mol. Struct.* 1, 463 .
- 72 Brown R.D. and Harcourt R.D. (1963) *Australian J. Chem.*, 16, 737.
- 73 Yadava V.S., Padmanabhan V.M. (1973) *Acta. Cryst.*, B29, 493-498.
- 74 Davidson E.R., Simpson W. T., Stewart, R. F., (1966), *J. Chem. Phys.*, 42, 3175.